

# YAMAHA NS-P30

Thank you for selecting this Yamaha NS-P30 speaker system.

“NS-P30” is the package number which includes the YAMAHA speaker systems NX-E70 and NX-C70.

NX-E70 is designed to be used as an effect speaker system, and NX-C70 is designed to be used as a center speaker system.

## PRECAUTIONS

Read these precautions carefully before using your speaker.

- Any time you note distortion, reduce the volume control on your amplifier to a lower setting. Never allow your amplifier to be driven into “clipping”. Otherwise the speaker may be damaged.
- When using an amplifier with a rated output power higher than the nominal input power of the speaker, care should be taken never to exceed the speaker’s maximum input.
- Do not attempt to clean the speaker with chemical solvents as this might damage the finish. To clean, wipe with a dry, soft cloth.
- To prevent the enclosure from warping or discoloring, do not place the speaker where it will be exposed to direct sunlight or excessive humidity.

- Do not place the speaker where it is liable to be knocked over or struck by falling objects. Stable placement will also ensure better sound performance.
- Placing the speaker on the same shelf or rack as the turntable can result in feedback.
- <For NX-E70 only>  
As these speakers contain strong magnets, avoid placing watches, magnetic tapes, etc. near them. Also, placing the speakers near a TV set may impair picture color. If this happens, move the TV set away from the speakers.
- **Secure placement or installation is the owner’s responsibility.**  
**YAMAHA shall not be liable for any accident caused by improper placement or installation of the speaker.**

## CONNECTION TO YOUR AMPLIFIER

**BEFORE MAKING CONNECTIONS, MAKE SURE THAT THE AMPLIFIER IS SWITCHED OFF.**

### ■ NX-E70

- Connect the push-type input terminals at the rear of the speakers to the speaker output terminals (for effect speakers) of your amplifier (or receiver) with the provided speaker cables.
- One side of the speaker cable has a white line and the other side has no line. Connect the (+) terminals on both the amplifier (or receiver) and the speakers using the side with a white line. Connect the (-) terminals on both components using the side with no line.
- Connect one speaker to the left (marked L) terminals of your amplifier (or receiver), and another speaker to the right (marked R) terminals, making sure not to reverse the polarity (+, -). If one speaker is connected with reversed polarity, the sound will be unnatural and lack bass.

Procedures:

- ① Press the tab on the terminal down, as shown in the figure.
- ② Insert the bare speaker wire end properly into the terminal hole. [Remove approx. 5 mm (1/4”) insulation from the speaker cable.]
- ③ Remove your finger from the tab to allow it to lock snugly on the cable’s wire end.
- ④ Test the security of the connection by tugging lightly on the cable at the terminal.

### ■ NX-C70

To connect the speaker cable from NX-C70 to the speaker output terminals (for a center speaker) on the amplifier (or receiver), make sure to connect the side with a white line to the (+) terminal and the side with no line to the (-) terminal.

NX-C70 (Center speaker)

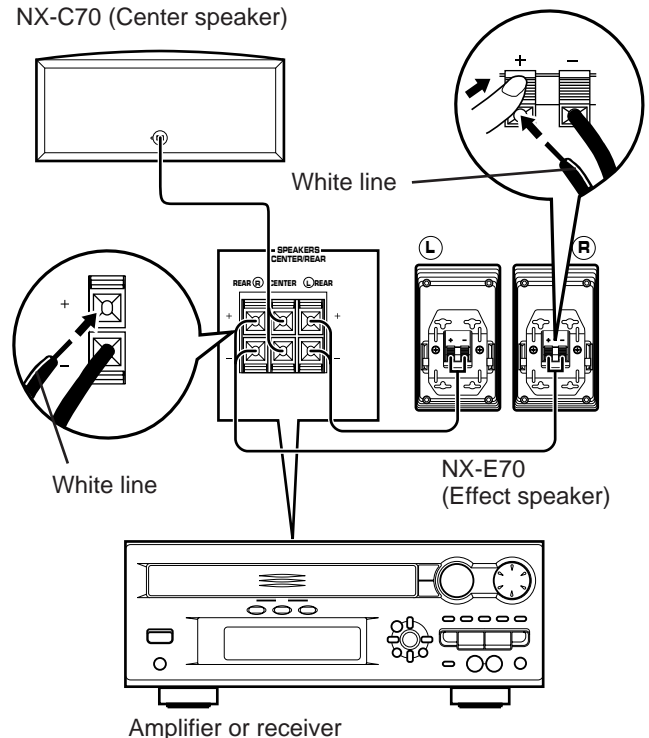

### Note

**Do not let the bare speaker wires touch each other as this could damage the speaker and/or the amplifier.**

## MOUNTING THE SPEAKERS

### ■ NX-E70

Mount the speakers on a shelf, rack or on the floor directly, or hang them on the wall.

#### To mount the speakers on a wall

- 1 Attach the provided mounting bracket to the rear of the speaker by using the provided screws.

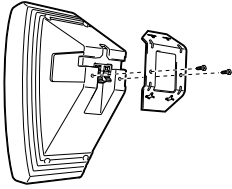

- 2 Fasten screws into a firm wall or wall support as shown in the diagram, and hang the holes of the mounting bracket on the protruding screws.

- \* The holes are arranged so that the speakers can be mounted in a side long, upright or upside-down way.
- \* Make sure that the screws are caught by a narrow part of the holes securely.

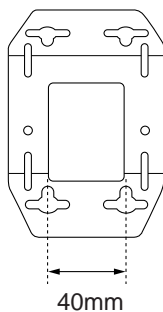
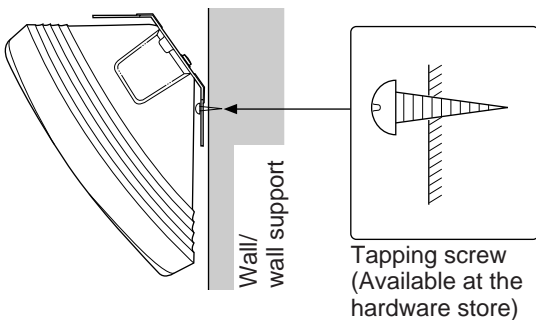

#### Notes

- Never attach the bracket to the speaker conversely.

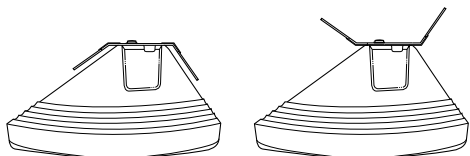

**Good**

**No good**

- Speaker cords should be connected to the speaker's terminals after the bracket has attached to the speaker to prevent the speaker cords pressed between the speaker and the bracket.

#### To hang in a side long way

Hang the speakers so that each of them faces inside as figured below.

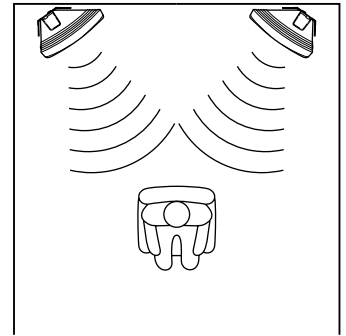
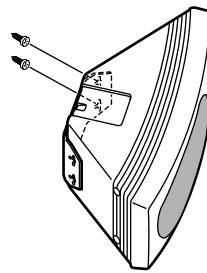

#### WARNING:

- Each speaker weighs 0.8 kg (1 lbs. 12 oz.). Do not mount them on thin plywood or soft wall surface material, as the screws may come out of the flimsy surface, causing the speakers to fall down and be damaged, or result in personal injury.
- Do not fasten the speakers to wall with nails, adhesives, or other unsound hardware. Long-term use and vibrations may cause them to fall down.
- To avoid accidents resulting from tripping over loose speaker cables, fix them to the wall.

### ■ NX-C70

Place the speaker on top of the TV or on the floor under the TV or inside the TV rack so that it is stabilized.

When placing the speaker on top of the TV, to prevent the speaker from falling down, put the provided pads at four points on bottom of the speaker.

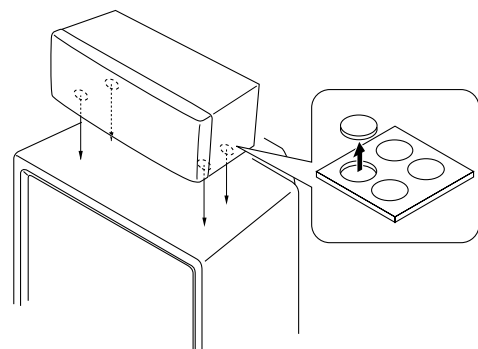

#### Notes

- Do not place the speaker on top of the TV whose area is smaller than the bottom area of the speaker. If placed, the speaker may drop out causing an injury to you.
- Though this speaker is a magnetically shielded type, there may be some influence on a TV picture depending on the type of TV or the placement of the speaker. In such a case, place the speaker apart from the TV so that there is no influence on TV picture.

## SPECIFICATIONS

Type	
NX-C70 .....	Full Range Speaker System (Magnetic-Shielding Type)
NX-E70 .....	Full Range Speaker System
Speakers	
NX-C70 .....	9 cm (3-9/16") full range speaker
NX-E70 .....	8 cm (3-1/8") full range speaker
Frequency Range	
NX-C70 .....	100 – 20,000 Hz
NX-E70 .....	110 – 20,000 Hz
Sound Pressure Level	
NX-C70 .....	85.0 dB
NX-E70 .....	85.0 dB
Maximum Power Handling Capacity	
NX-C70 .....	27W
NX-E70 .....	13.5W
Impedance	
NX-C70 .....	8 ohms
NX-E70 .....	4 ohms
Dimensions (W x H x D)	
NX-C70 .....	280 x 123 x 140 mm (11" x 4-13/16" x 5-1/2")
NX-E70 .....	200 x 115 x 105 mm (7-7/8" x 4-1/2" x 4-1/8")
Weight	
NX-C70 .....	1.5 kg (3 lbs. 5 oz.)
NX-E70 .....	0.8 kg (1 lbs. 12 oz.) x 2
Accessories .....	
	Speaker cord x 2
	Pad x 4
	Screw x 4
	Mounting bracket x 2

- \* Specifications subject to change without notice due to product improvements.
- \* Care should be taken not to exceed the input power values noted above.

# YAMAHA

---

YAMAHA ELECTRONICS CORPORATION, USA 6660 ORANGETHORPE AVE., BUENA PARK, CALIF. 90620, U.S.A.  
YAMAHA CANADA MUSIC LTD. 135 MILNER AVE., SCARBOROUGH, ONTARIO M1S 3R1, CANADA  
YAMAHA ELECTRONIK EUROPA G.m.b.H. SIEMENSSTR. 22-34, 25462 RELINGEN BEI HAMBURG, FR. OF GERMANY  
YAMAHA ELECTRONIQUE FRANCE S.A. RUE AMBROISE CROIZAT BP70 CROISSY-BEAUBOURG 77312 MARNE-LA-VALLEE CEDEX02, FRANCE  
YAMAHA ELECTRONICS (UK) LTD. YAMAHA HOUSE, 200 RICKMANSWORTH ROAD WATFORD, HERTS WD1 7JS, ENGLAND  
YAMAHA SCANDINAVIA A.B. J A WETTERGRENS GATA 1, BOX 30053, 400 43 VÄSTRA FRÖLUNDA, SWEDEN  
YAMAHA MUSIC AUSTRALIA PTY, LTD. 17-33 MARKET ST., SOUTH MELBOURNE, 3205 VIC., AUSTRALIA

YAMAHA CORPORATION  
VZ41800