

YAMAHA YST-A5

Natural Sound Active Servo Processing Amplifier
50W + 50W (8Ω) RMS Output Power, 0.015% THD, 20-20,000 Hz
2-Types of Input Terminals
Clipping Indicator

Thank you for purchasing the YAMAHA model YST-A5 Active Servo Processing Amplifier.

CENTER

OWNER'S MANUAL



CONTENTS

Safety Instructions	2
Caution	3
The Active Servo Technology	5
Connection of the Active Servo Processing Cartridge	5
Front/Rear Panel Components and Their Functions	6
Connections	7
Troubleshooting	8
Specifications	8

IMPORTANT!

Please make a note of the serial number of this unit in the space indicated below.

Model: **YST-A5**
Serial No.:

The serial number is inscribed on the rear of the unit. Keep this Owner's Manual in a safe place for future reference.

SAFETY INSTRUCTIONS

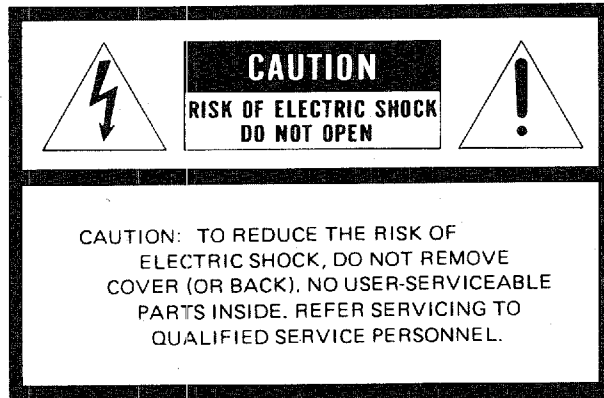

• Explanation of Graphical Symbols

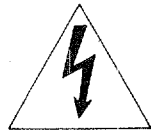

The lightning flash with arrowhead symbol, within an equilateral triangle, is intended to alert you to the presence of uninsulated "dangerous voltage" within the product's enclosure that may be of sufficient magnitude to constitute a risk of electric shock to persons.

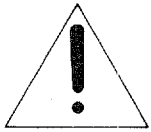

The exclamation point within an equilateral triangle is intended to alert you to the presence of important operating and maintenance (servicing) instructions in the literature accompanying the appliance.

WARNING

To reduce the risk of fire or electric shock, do not expose this appliance to rain or moisture.

1 Read Instructions – All the safety and operating instructions should be read before the appliance is operated.

2 Retain Instructions – The safety and operating instructions should be retained for future reference.

3 Heed Warnings – All warnings on the appliance and in the operating instructions should be adhered to.

4 Follow Instructions – All operating and other instructions should be followed.

5 Water and Moisture – The appliance should not be used near water – for example, near a bathtub, washbowl, kitchen sink, laundry tub, in a wet basement, or near a swimming pool, etc.

6 Carts and Stands – The appliance should be used only with a cart or stand that is recommended by the manufacturer.

6A An appliance and cart combination should be moved with care. Quick stops, excessive force, and uneven surfaces may cause the appliance and cart combination to overturn.



7 Wall or Ceiling Mounting – The appliance should be mounted to a wall or ceiling only as recommended by the manufacturer.

8 Ventilation – The appliance should be situated so that its location or position does not interfere with its proper ventilation. For example, the appliance should not be situated on a bed, sofa, rug, or similar surface, that may block the ventilation openings; or placed in a built-in installation, such as a bookcase or cabinet that may impede the flow of air through the ventilation openings.

9 Heat – The appliance should be situated away from heat sources such as radiators, stoves, or other appliances that produce heat.

10 Power Sources – The appliance should be connected to a power supply only of the type described in the operating instructions or as marked on the appliance.

11 Power-Cord Protection – Power-supply cords should be routed so that they are not likely to be walked on or pinched by items placed upon or against them, paying particular attention to cords at plugs, convenience receptacles, and the point where they exit from the appliance.

12 Cleaning – The appliance should be cleaned only as recommended by the manufacturer.

13 Nonuse Periods – The power cord of the appliance should be unplugged from the outlet when left unused for a long period of time.

14 Object and Liquid Entry – Care should be taken so that objects do not fall into and liquids are not spilled into the inside of the appliance.

CAUTION: READ THIS BEFORE OPERATING YOUR UNIT

15 Damage Requiring Service – The appliance should be serviced by qualified service personnel when:

- A.** The power-supply cord or the plug has been damaged; or
- B.** Objects have fallen, or liquid has been spilled into the appliance; or
- C.** The appliance has been exposed to rain; or
- D.** The appliance does not appear to operate normally or exhibits a marked change in performance; or
- E.** The appliance has been dropped, or the cabinet damaged.

16 Servicing – The user should not attempt to service the appliance beyond those means described in the operating instructions. All other servicing should be referred to qualified service personnel.

17 Power Lines – An outdoor antenna should be located away from power lines.

18 Grounding or Polarization – The precautions that should be taken so that the grounding or polarization is not defeated.

1 To ensure the finest performance, please read this manual carefully. Keep it in a safe place for future reference.

2 Install your unit in a cool, dry, clean place – away from windows, heat sources, and too much vibration, dust, moisture or cold. Avoid sources of hum (transformers, motors). To prevent fire or electrical shock, do not expose to rain and water.

3 Do not operate the amplifier upside-down. It may overheat, possibly causing damage.

4 Never open the cabinet. If a foreign object drops into the set, contact your dealer.

5 Do not place records or other objects on top of the amplifier; this will block the ventilation holes, cause the internal temperature to rise and may result in a failure.

6 Do not use force on switches, knobs or cords. When moving the set, first turn the unit off. Then gently disconnect the power plug and the cords connecting to other equipment. Never pull the cord itself.

7 Do not attempt to clean the unit with chemical solvents; this might damage the finish. Use a clean, dry cloth.

8 Be-sure to read the "Troubleshooting" section on common operating errors before concluding that your unit is faulty.

9 Do not connect audio equipment to the AC outlets on the rear panel if that equipment requires more power than the outlets are rated to provide.

CONNECTIONS

1

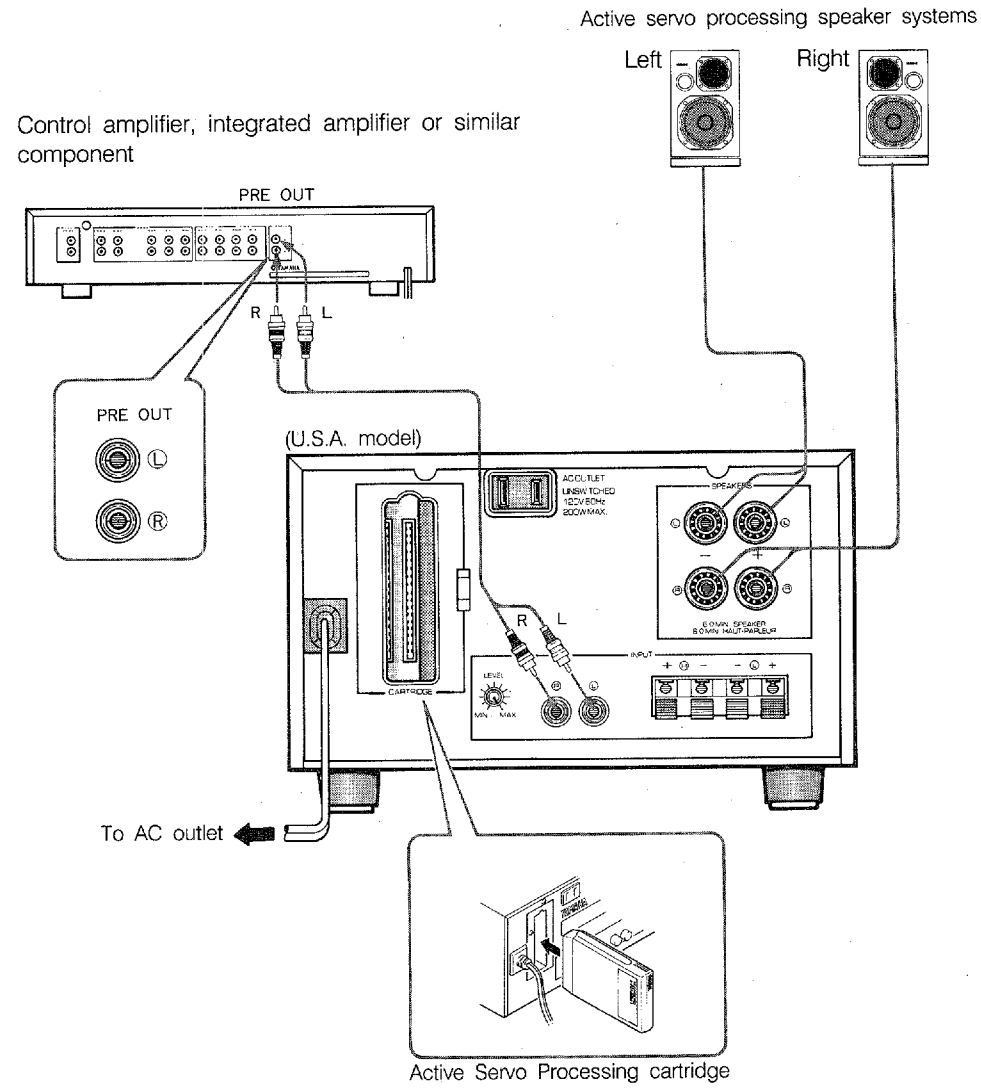

2

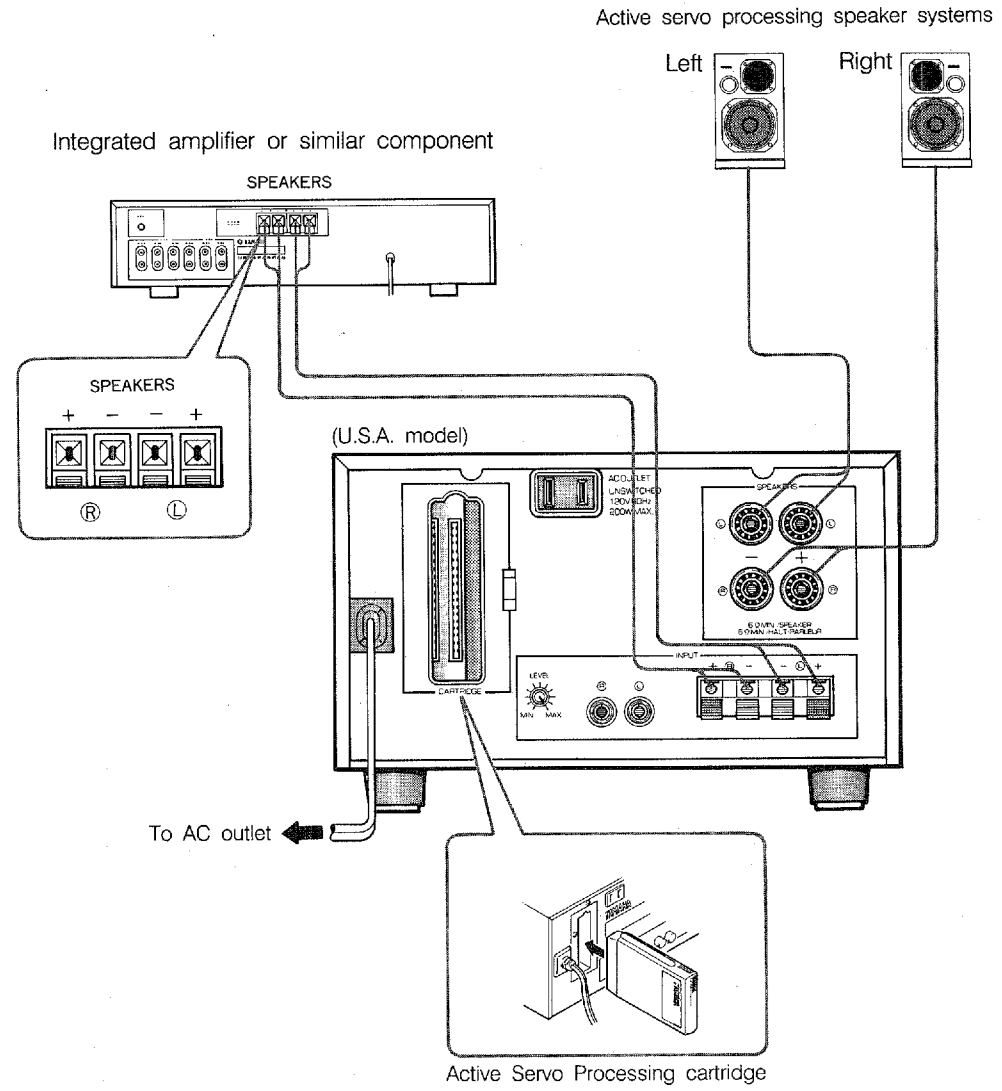

THE ACTIVE SERVO TECHNOLOGY

The theory of the Active Servo Technology is based upon two major factors, the Helmholtz resonator and negative-impedance drive. Active Servo Processing speakers reproduce the bass frequencies through an "air woofer", which is a small port or opening in the speaker's cabinet. This opening is used instead of, and performs the functions of, a woofer in a conventionally designed speaker system. Thus, signals of low amplitude within the cabinet can, according to the Helmholtz resonance theory, be output from this opening as waves of great amplitude if the design is such that the size of the opening and the volume of the cabinet are in the correct proportion to satisfy a certain ratio. In order to accomplish this, moreover, the amplitudes within the cabinet must be both precise and of sufficient power because these amplitudes must overcome the "load" presented by the air that exists within the cabinet.

Thus it is that this problem is resolved through the employment of a design in which the amplifier functions to supply the signals. If the electrical resistance of the voice coil is reduced to zero, the movement of the speaker unit would become linear with respect to signal voltage, and, to accomplish this, a special negative-impedance output-drive amplifier for subtracting output impedance of the amplifier is used. By employing negative-impedance drive circuits, the amplifier is able to generate precise, low-amplitude low-frequency waves with superior damping characteristics, and these waves are then radiated from the cabinet opening as high-amplitude signals. The system can, therefore, by employing the negative-impedance output drive amplifier and a speaker cabinet with the Helmholtz resonator, reproduce an extremely wide range of frequencies with amazing sound quality and less distortion. The features described above, then, are combined to be the fundamental structure of the Active Servo Technology.

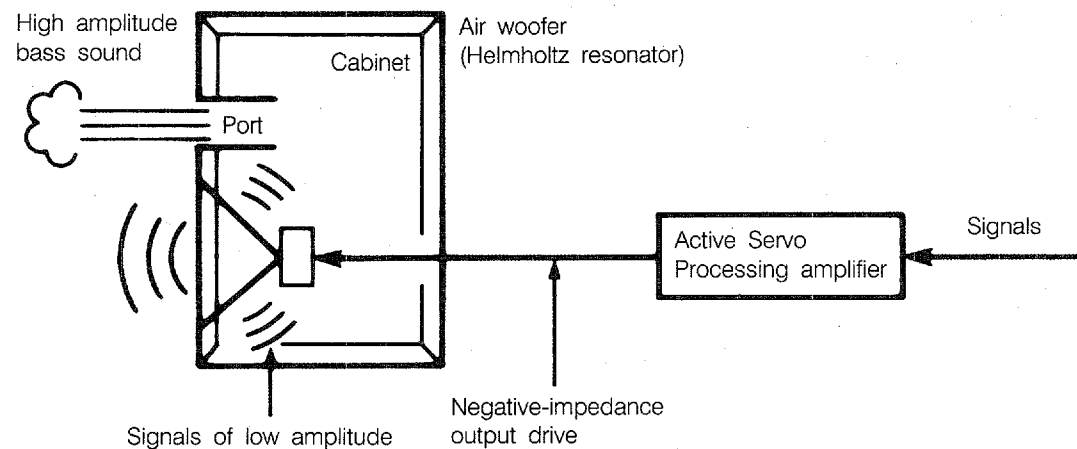

CONNECTION OF THE ACTIVE SERVO PROCESSING CARTRIDGE

For negative-impedance drive of Active Servo Processing speaker systems by this unit, the Active Servo Processing cartridge that is included with Active Servo Processing speaker systems (and which is designed especially for those speaker systems) must be inserted into the cartridge holder located on the rear panel of this unit.

As shown in the figure below, insert the cartridge so that the connector end of the cartridge enters the cartridge holder.

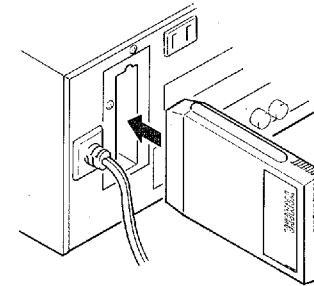

NOTE

Never attempt to use this unit to drive conventional speakers while the Active Servo Processing cartridge is inserted in this unit, because to do so may cause damage to this unit and/or the speakers.

When using this unit to drive conventional speakers

By inserting the STANDARD CARTRIDGE (provided with this unit) instead of the Active Servo Processing cartridge into the cartridge holder, this unit can be used to drive conventional speakers.

NOTE

Be absolutely sure that this unit's power is OFF before connecting or disconnecting the cartridge to or from this unit.

FRONT/REAR PANEL COMPONENTS AND THEIR FUNCTIONS

FRONT PANEL

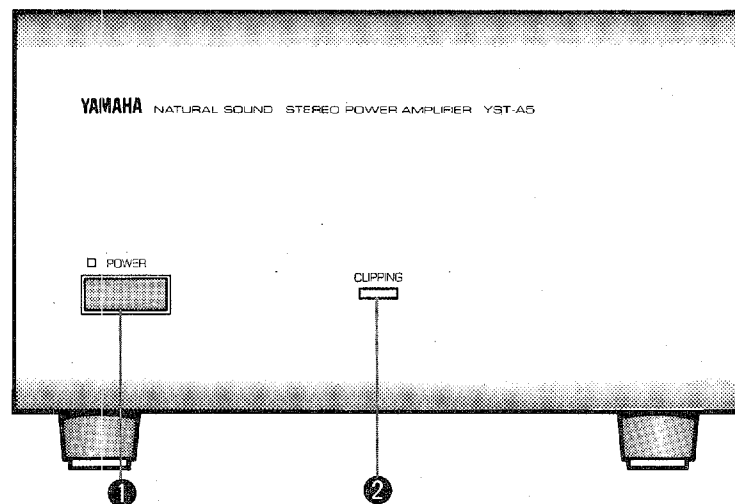

① POWER switch/indicator

Press this switch to switch ON the power. The indicator above it will illuminate while the power is ON. Press the switch again to switch OFF the power. Note the following cautions.

- Before switching ON the power, be sure to set the volume control(s) of other components (such as the control amplifier, integrated amplifier, etc.) to the lowest setting in order to avoid damage to the speakers.
- The speaker-protection circuit functions to mute speaker sound reproduction for a few seconds after the power is switched ON.

② CLIPPING indicator

This indicator illuminates if an overload is applied to this unit due to excessive input. (When this indicator illuminates, reduce the input level by using the output level control on the control amplifier or other component connected to this unit.)

REAR PANEL

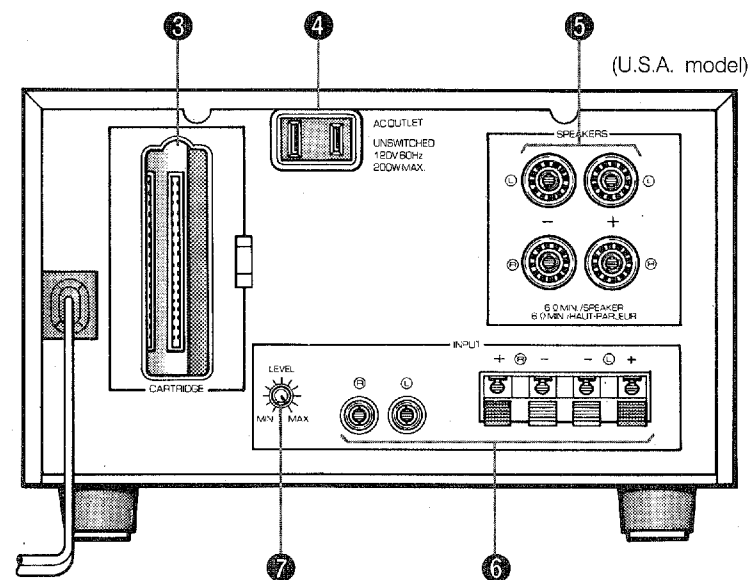

③ CARTRIDGE holder

Insert the Active Servo Processing cartridge into this holder.

④ UNSWITCHED AC outlet

(General, U.S.A. and Canada models only)

This unswitched AC outlet can be used for connection of the power cord from another audio component. Note that the power to that component is not affected by the ON or OFF setting of the POWER switch of this unit.

Note: The component connected here should have a rating of no more than 200W.

⑤ SPEAKERS terminals

These terminals are for connections to the speaker systems. Refer to the section "CONNECTIONS" for detailed information.

⑥ INPUT terminals

These terminals are for connections from a control amplifier, integrated amplifier or similar component. Refer to the section "CONNECTIONS" for detailed information.

⑦ INPUT LEVEL control

This control can be used to adjust the level of the input signal. Turn it clockwise to increase the level. By leaving it set to the "MAX" position, you can make an overall adjustment of the level of the sound by using the control on the control amplifier or other component. If a component without an output level control is connected to this unit, use this control to make the adjustment.

CONNECTIONS

- Before attempting to make any connections to or from this unit, be sure to first switch OFF the power to this unit and to any other components to which connections are being made.
- When making connections between this unit and other components, be sure all connections are made correctly, that is to say L (left) to L, R (right) to R, "+" to "+" and "-" to "-".

CONNECTIONS TO A CONTROL AMPLIFIER, INTEGRATED AMPLIFIER OF SIMILAR COMPONENT

Note

This unit has two types of INPUT terminals; be sure, when making connections, to use only one type or the other.

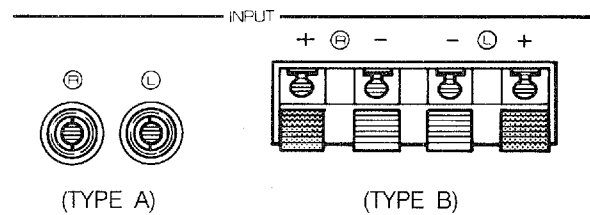

- Make connections from the "PRE OUT" terminals of a control amplifier, integrated amplifier or a similar component to the INPUT terminals (TYPE A) by using pin plug type of connection cords. (See Fig. 1 on page 4.)

- If the amplifier or other component you are using is not equipped with "PRE OUT" terminals, make connections from the "SPEAKERS" terminals of the amplifier or other component to the INPUT terminals (TYPE B) of this unit by using connection wires. (See Fig. 2 on page 4.)

Connections to the INPUT terminals (TYPE B)

1. Strip off about 10 mm (3/8 in.) of the insulation (leaving only the core wire) from the end of each connection wire to be connected to this unit.
2. Press the lever below one of the INPUT terminals and insert this exposed core wire into the hole, as shown in the illustration. When the lever is then released, the wire is locked in securely.

Red: positive (+)
Black: negative (-)

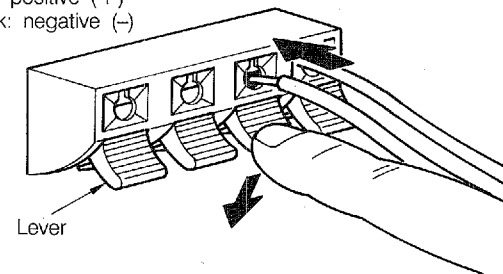

The connection wires should be no longer than necessary.

- * When making connections, be sure that the exposed part of the speaker connection wire does not contact two terminals at the same time.

SPEAKER CONNECTIONS

1. Strip off about 10 mm (3/8 in.) of the insulation (leaving only the core wire) from the end of each speaker connection wire to be connected to this unit.
2. Unscrew the knob (for the SPEAKER connection terminal to which the speaker connection wire is to be connected) until the wire can be inserted into the hole at the top of the rear part of the knob. Each speaker connection wire should be inserted securely, taking care that it does not contact any other terminal. Then turn the knob to tighten the knob securely.

Red: positive (+)
Black: negative (-)

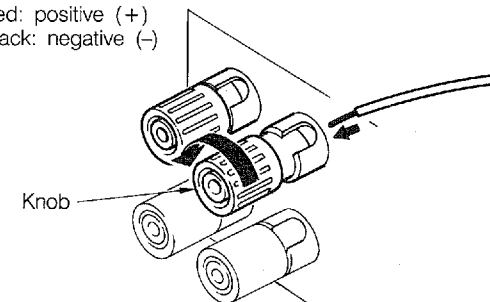

The speaker connection wires should be no longer than necessary.

- * Be sure that the connection wires are correctly connected between this unit and the speaker systems, that is to say L (left) to L and R (right) to R.
 - * Note that there are two terminals (one positive and one negative) for each speaker system cabinet. The red terminal must be connected to the positive (+) terminal on the speaker system, and the black terminal to the negative (-) terminal on the speaker system.
- If connections are not correct, the sound reproduced from the speaker systems will seem unnatural, with insufficient stereo effect, sound will seem localized between the speaker systems, and low-range sound will be unsatisfactory.
- * Be sure that the impedance of the speaker systems is within the specified range for this unit.

TROUBLESHOOTING

If the unit fails to operate normally, check the following points to determine whether the problem can be corrected by the simple measures suggested. If it cannot, or if the problem is not listed in the SYMPTOM column, disconnect the unit's power cord and contact your dealer or service center for assistance.

Symptom	Probable Cause	Remedy
The power is not switched ON when the POWER switch is pressed.	The power cord plug is not connected securely to the wall power outlet.	Connect it securely.
No sound is heard.	The INPUT LEVEL control is set all the way to the "MIN" position.	Turn them clockwise.
	The connection cords are not connected securely to the INPUT terminals.	Connect them securely.
	The speaker systems are not properly connected to this unit.	Connect them correctly.
The acoustic "image" is unstable, characterized by unnatural sound and insufficient low-range tonal quality.	The positive (+) and negative (-) polarities (of this unit and the speaker systems) are not matched.	Reconnect the speaker systems to this unit so that the polarities are aligned.
Hum noise is heard from the speakers.	The connection cords are not connected securely to the INPUT terminals.	Connect them securely.

SPECIFICATIONS

Rated outputs

Minimum RMS output power per channel

(20 Hz - 20 kHz)

0.015% THD, 8 ohms 50W

0.02% THD, 6 ohms 53W

Dynamic Power per channel

(1 kHz, 8 ohms/6 ohms/4 ohms) ... 70W/80W/110W

Power Band Width (0.05% THD, 25W/8 ohms)

..... 10 Hz - 50 kHz

Damping Factor (1 kHz, 8 ohms) 80 or more

Input Sensitivity/Input Impedance

INPUT (TYPE A) 700 mV/20 k-ohms

INPUT (TYPE B) 10V/4.4 k-ohms

Frequency Response ... 20 Hz - 20 kHz, +0/-0.3 dB

Total Harmonic Distortion

(20 Hz - 20 kHz, 25W/8 ohms) 0.012%

Signal-to-Noise Ratio (IHF-A-Network, Shorted)

..... 104 dB

Rated Supply Consumption

Europe model AC 220V, 50 Hz

General model AC 110/120/220/240V, 50/60 Hz

U.K. and Australia models AC 240V, 50 Hz

U.S.A. and Canada models AC 120V, 60Hz

Rated Power Consumption 180 W

AC Outlet (Except Europe, U.K. and Australia models)

UNSWITCHED x 1 200W max.

Dimensions (W x H x D) 217 x 136 x 352 mm

(8-9/16" x 5-3/8" x 13-7/8")

Weight 4.8 kg (10 lbs. 9 oz.)

* Please note that the design and all specifications are subject to change without notice.

* The numerical values noted above are based upon the use of a standard cartridge, and so may vary depending upon the cartridge used.

YAMAHA ELECTRONICS CORPORATION, USA 6722 ORANGETHORPE AVE., BUENA PARK, CALIF. 90620, U.S.A.
 YAMAHA CANADA MUSIC LTD. 135 MILNER AVE., SCARBOROUGH, ONTARIO M1S 3R1, CANADA
 YAMAHA ELECTRONIK EUROPA G.m.b.H. 2084 RELLINGEN, BEI HAMBURG, SIEMENSSTR. 22/34, F.R. OF GERMANY
 YAMAHA ELECTRONIQUE FRANCE S.A. 17 RUE DES CAMPANULES, LOGNES 77321 MARNE LA VALLEE CEDEX 2, FRANCE
 YAMAHA ELECTRONICS (UK) LTD. YAMAHA HOUSE, 200 RICKMANSWORTH ROAD WATFORD, HERTS WD1 7JS, ENGLAND
 YAMAHA SCANDINAVIA A.B. J A WETTERGRENS GATA 1, BOX 30053, 400 43 VÄSTRA FRÖLUNDA, SWEDEN
 YAMAHA MUSIC AUSTRALIA PTY, LTD. 17-33 MARKET ST., SOUTH MELBOURNE, 3205 VIC., AUSTRALIA

YAMAHA
 YAMAHA CORPORATION
 10-1 NAKAZAWA-CHO, HAMAMATSU, JAPAN
 V121480-0 Printed in Japan BWgW, g