

YAMAHA

STEREO PRE-AMPLIFIER

C-4

OWNER'S MANUAL

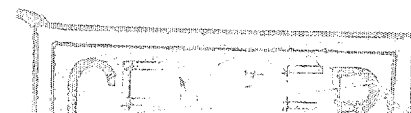
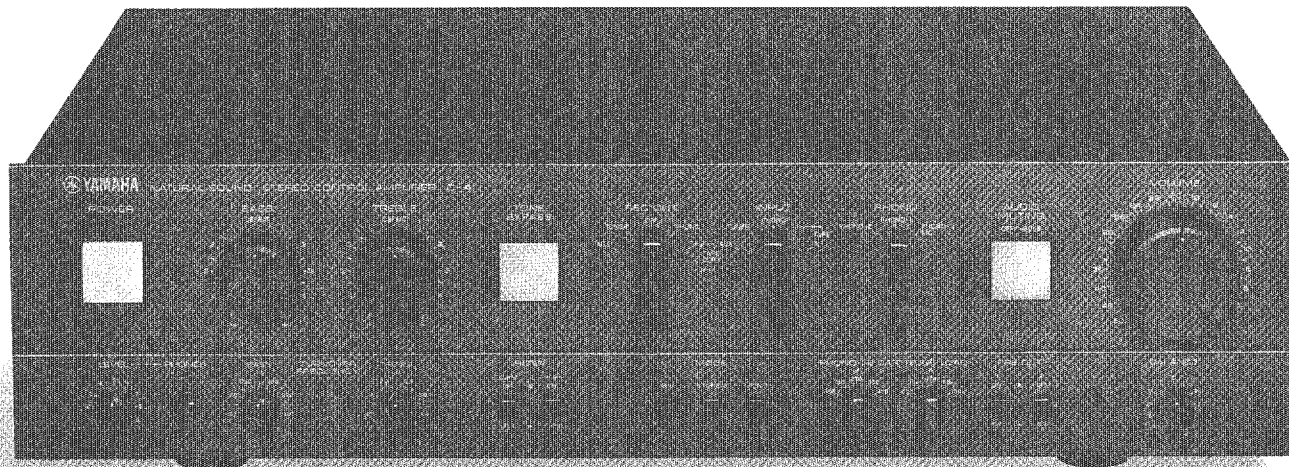

YAMAHA offers you thanks and congratulations on your choice of the Stereo Control Amplifier C-4.

The C-4 combines in a modern and functional control amplifier the same standards of knowhow that have made available YAMAHA's top-notch control amplifiers C-1 and C-2 with new developments including the improved signal-to-noise ratio at the time of cartridge installation and the continuously variable frequency turnover ability. It further embodies many functional facilities, i.e. TONE BYPASS, REC OUT SELECTOR, CARTRIDGE LOAD CONTROLS as well as the built-in headphone amplifier and the MC amplifier, to make itself a truly talented performer.

In order to make the most of the C-4's excellent performance ability for its long service life, please read this manual carefully before starting to use it.

FEATURES

- The Equalizer Amplifier adopts a dual FET differential amplifier in the first stage. A sufficient dynamic margin of 285mV (1 kHz, 0.01% distortion) and an excellent 85dB SN ratio are available. Special about the C-4 is a high SN ratio and a low distortion factor at the time of actual cartridge installation. Further, the RIAA deviation within $\pm 0.2\text{dB}$ (20Hz~20kHz) ensures flat frequency response, making possible high-fidelity reproduction of recorded signals to the maximum extent.
- The Head Amplifier for MC cartridge uses a 4-stage symmetrical push-pull circuit. It enables an extensive noise reduction of better than 77dB SN ratio, which more than satisfies MC cartridge requirements.
- The PHONO-1, -2 Input Circuit are provided with a MM cartridge load switch capable of 5-step switchover in load resistance and load capacity. Installation of the 100Ω position, especially, means improved matching characteristics with low impedance and high output MC cartridges. Availability of a varying load capacity means different characteristics also obtainable from the same and one phono cartridge to permit fine selection of sound quality in reproduction.
- The TONE BYPASS Switch enables bypassing the tone circuit, whereby the C-4, despite of its rich functional talents, allows a simple circuit configuration to produce higher sound quality.
- The 4-gang VOLUME Control with dB display fade both equalizer amplifier and flat amplifier output stages simultaneously so as to greatly improve the SN ratio in a small volume. Adoption of low impedance volume makes possible flat frequency characteristics and good separation.
- The Tone Control Circuit capable of continuously variable frequency turnover is adopted. It makes possible delicate and diversified sound control which the conventional amplifiers cannot achieve.
- Yamaha's unique REC OUT Selector Switch allows recording another program while it is reproducing one.
- The REC OUT and PRE OUT terminals use a muting relay to prevent noise with On and Off of the power.
- The functional panel layout is enhanced to unique Yamaha beauty, with the keynote of color in black.

CONTENTS

Caution; Read this Before Operating Your C-4 .	3
Connection Diagram	4
Front Panel and Controls	6
Connections and How to use	9
Additional Functions	14
Specifications	16
Block Diagram	17
Schematic Diagram	18
Trouble Shooting	19

IMPORTANT!

Please record the serial number of your unit in the space below

Model Name C-4

Serial No. _____

The serial number is located on the rear of the chassis.
Retain this Owner's Manual in a safe place for future reference.

C-4

CAUTION ; READ THIS BEFORE OPERATING YOUR C-4

1

The C-4 is a high performance pre-amplifier with low distortion and versatile controls. This manual is required reading if you are to get the best from its special features and controls.

2

Do not drop or otherwise jar the C-4, which is a precision electronic instrument.

3

Do not place the C-4 where it will be exposed to direct sunlight, excessive heat (for instance over a radiator), cold, moisture, or dust.

4

Do not use chemical solvents (such as benzene or alcohol) to remove traces of dirt. Wipe only with a soft, slightly damp cloth.

5

Do not attempt to carry out internal adjustments or repairs. Leave these to your local service representative.

6

Do not assume your C-4 is faulty before checking the Trouble Shooting list on page 19 for common operating errors.

7

Operate all switches and knobs in accordance with the instructions. Avoid applying undue force, which should never be necessary, and do not attempt to use intermediate settings.

8

Note that the muting circuit keeps the C-4 silent for several seconds after switching ON, to prevent the pops and clicks that can occur.

9

Do not connect other audio equipment to the spare AC outlet sockets on the rear panel if they will require more power than the outlets are rated to provide.

10

Keep this manual in a safe place for future reference, and refer to it frequently until you are perfectly familiar with all C-4 controls and functions.

Warning — to prevent fire or shock hazard, do not expose this appliance to rain or moisture.

C-4

CONNECTION DIAGRAM

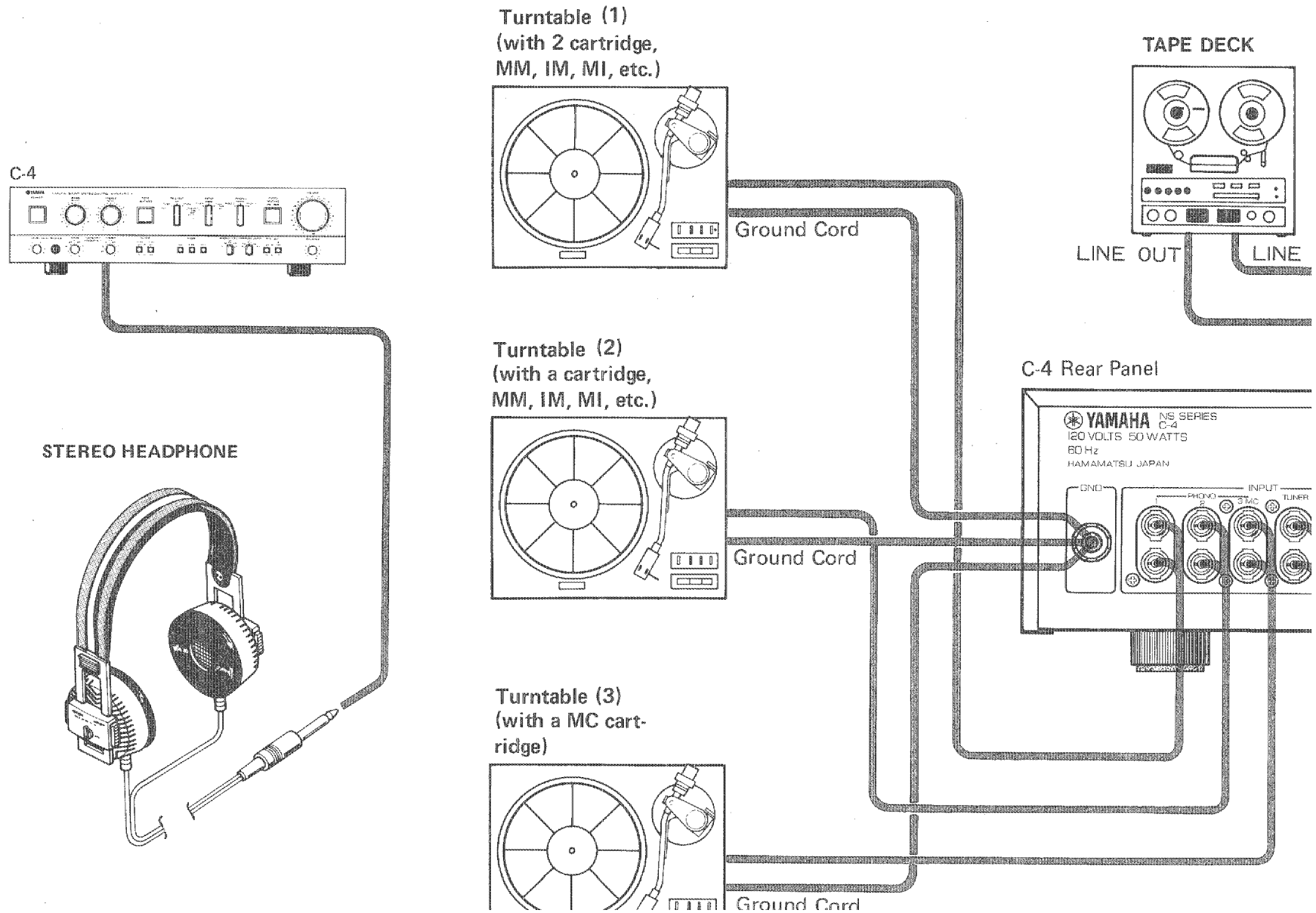

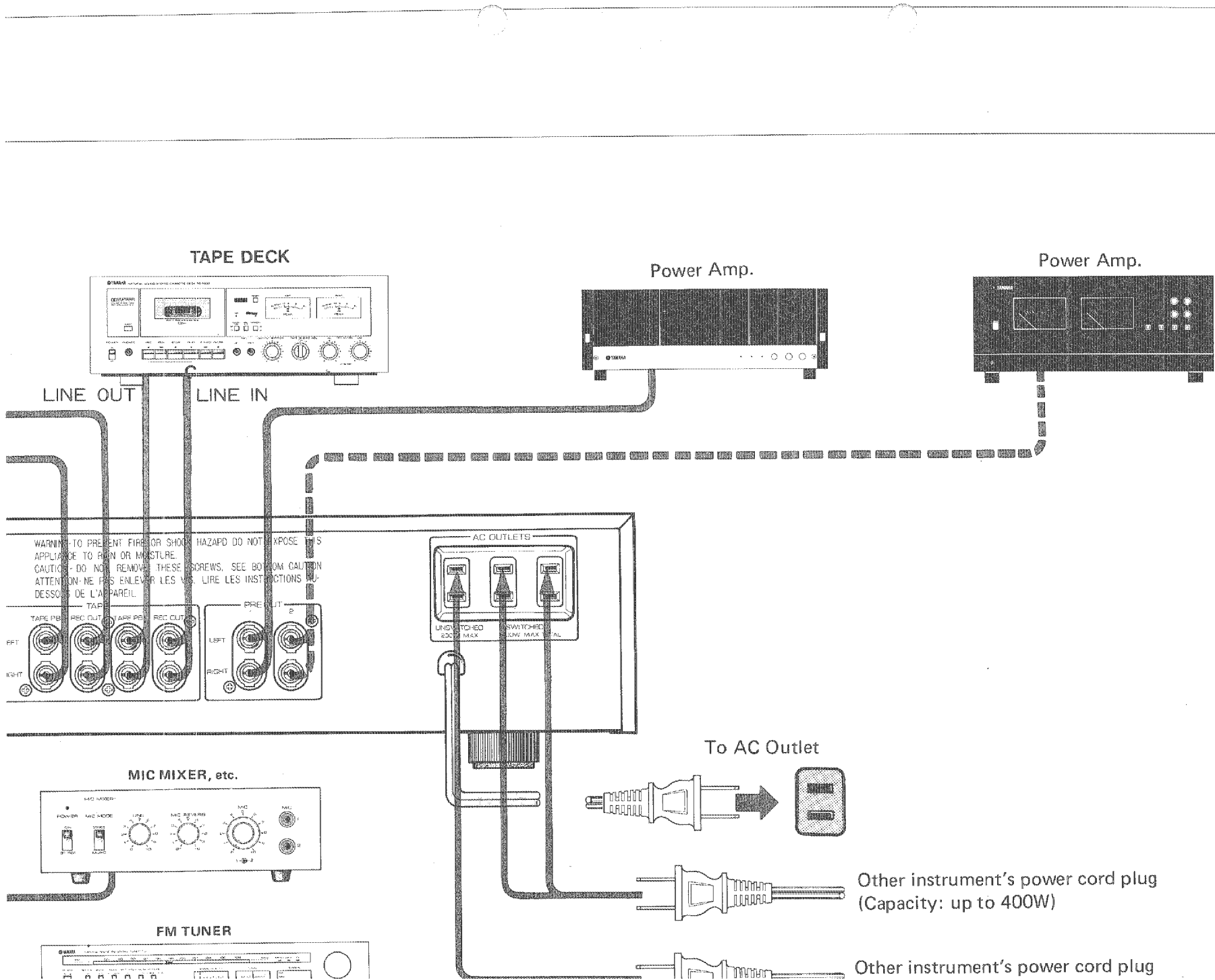

WARNING TO PREVENT FIRE OR SHOCK HAZARD DO NOT EXPOSE THIS
 APPLIANCE TO RAIN OR MOISTURE.
 CAUTION - DO NOT REMOVE THESE SCREWS. SEE BOTTOM CAUTION
 ATTENTION - NE PAS ENLEVER LES VIS. LIRE LES INSTRUCTIONS
 DESSOUS DE L'APPAREIL.

To AC Outlet

Other instrument's power cord plug
 (Capacity: up to 400W)

Other instrument's power cord plug

C-4

FRONT PANEL AND CONTROLS

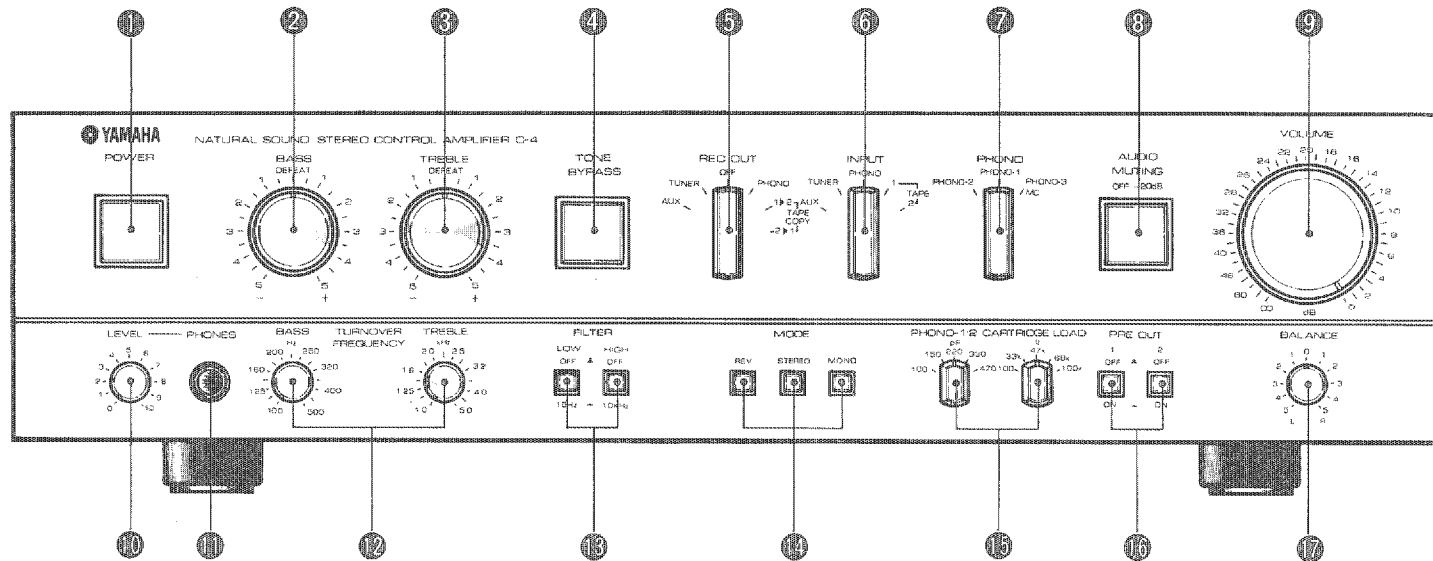

1 POWER Switch

Push this switch, and the C-4 will be supplied with AC power and a lamp inside the switch will light. Push again to turn OFF power.

- *1. In several seconds after pushing the button on, sounds are not produced because the muting relay functions to eliminate pop noise.
- *2. Before pushing ON the POWER switch, always place the VOLUME knob in the minimum position (fully counterclockwise: ∞) so as not to gain an indiscreetly large sound.

2 BASS-Tone Control

(The defeat position in the center is the flat condition point.)
This enables you to emphasize low frequency sounds (rhythm section, etc.) or to reduce them if your speakers sound 'boomy.' Turning to the right increases the bass response, and turning to the left reduces it.

3 TREBLE-Tone Control

(The defeat position in the center is the flat condition point.)
This works similarly for the high frequencies.

Sometimes turning slightly to the left, to reduce high frequency response, can cut out unwanted 'hiss' noise or record scratch, although turning too far will give an unnatural or muffled sound. Turning to the right increases high frequency response to compensate for absorption by soft furnishings, curtains, etc.

* Refer to page 14 "TONE CONTROLS/TURNOVER FREQUENCY CONTROLS."

4 TONE BYPASS Switch

When this push-button switch is pushed the indication lamp lights and sound signals are made to bypass the control circuit.

That is, the DC equalizer connects with the DC flat amplifier directly, and accordingly ensures high sound quality. The button pushed once more, the light goes off and the tone control circuit is re-connected.

* While the lamp is lighted, the filter switches ⑫, and the tone controls ⑬, ⑭, and ⑮, do not function even they are operated. Please do not operate this tone bypass switch when the tone control is left furthest to the right (+), otherwise a sudden change of the sound volume is caused and it will exercise bad influence on the speakers.

⑩ REC OUT Selector Switch

This switch sends out signals for recording to a tape deck connected.

Regardless of the position of the INPUT selector switch, this switch permits selection of a desired program source connected.

*1. Recording is impossible when the switch is in OFF position.

*2. Please refer to Page 12 for how to use.

⑪ INPUT Selector Switch

This is a switch for selection of connected program sources.

Change the switch matched with a program source according to the table upper right.

INPUT Selector Switch	Program Source
AUX	Playback from an equipment connected to the Aux terminals
TUNER	Broadcasting Reception
PHONO	DISC Audition
TAPE-1	Playback from an Tape Deck 1 connected to the TAPE-1 terminals
TAPE-2	Playback from an Tape Deck 2 connected to the TAPE-2 terminals

⑫ PHONO Input Selector Switch

It is the switch to select a turntable connected. Note; Please be sure that a turntable with a MC cartridge is connected to the PHONO-3/MC terminal without fail.

To this PHONO-3/MC terminal, do not connect a high output cartridge such as a MM cartridge.

PHONO Input Selector Switch Position	Type of Cartridge on Turntable
PHONO-1	MM type (IM, MI types, etc.) (i.e. moving magnet type)
PHONO-2	do.,
PHONO-3/MC	MC type (moving coil type) cartridge

⑬ AUDIO MUTING Switch

When the button switch is pressed the lamp goes off and a straight 20dB reduction is made in the amplifier gain.

The button pressed once more, the lamp lights and the gain is brought back.

* Suppose that this switch is left ON (i.e. the light keeps off) and the VOLUME ⑭ is turned to the light to effect an increase in the sound volume.

After that switching OFF the button in this case produces a sudden change in the sound volume and will resultantly exercise bad influence on the speakers. Please be careful so as to prevent such.

⑭ VOLUME Control

This knob permits you to control the overall sound volume. Turn it clockwise to increase the sound volume.

* When turning ON the POWER switch, always turn this switch fully counterclockwise (∞) so as not to be given an indiscreetly large sound.

⑮ LEVEL

(Headphone Level Control)

It controls the headphone sound volume. Turning it to the right (clockwise) gives an increase in the sound volume.

* When the VOLUME ⑭ is left furthest to the left (anti-clockwise), no sound is produced by turning the control to the right.

⑩ PHONES (Headphones Jack)

Connect your stereo headphones to this jack, and use the level control ⑩ to obtain sound volume of your choice.

⑩ TURNOVER FREQUENCY Controls

BASS: This varies the turnover frequency in the low frequency range of the tone control. Turning it to the right produces an increase in the turnover frequency in the low frequency range, and turning it to the left produces a decrease in the same.

* Please refer to "TONE CONTROLS/TURNOVER FREQUENCY CONTROLS" in Page 14.

TREBLE: It varies the turnover frequency in the high frequency range of the tone control. Turning it to the right produces an increase in the turnover frequency of the high frequency range, and turning it to the left produces a decrease in the same.

* Please refer to "TONE CONTROLS/TURNOVER FREQUENCY CONTROLS" in Page 14.

⑩ FILTER Switches

LOW: When this button switch is pushed (), ultra low frequency noise below 15Hz out the audible frequency range, normally unnecessary for music reproduction, is cut-off so as to prevent the speakers' ultra low frequency reaction (fluttering of cone paper) due to a warped disc.

* Leave this switch ON () while the TONE BYPASS Switch is OFF to protect the speakers.

HIGH: Pushing this button switch () cuts high frequency noise components over 10KHz.

* Leave it OFF () for normal use.

⑩ MODE Switches

The switch makes choice of mode to match a program source connected to the input terminals.

STEREO: When the button is pushed (), ordinary stereophonic reproduction is obtained.

REV: Pushing this button () produces reverse stereo reproduction, where the right and left channels are reversed.

MONO: Monaural reproduction is obtained by pushing the button ().



⑩ PHONO-1,-2 CARTRIDGE LOAD Switches

The "Ω" switch allows selection of the optimum load resistance for a MM (moving magnet type) cartridge on the turntable connected to the PHONO-1 or -2 terminals, and the "pF" switch allows selection of the optimum load capacity.

* Refer to "CARTRIDGE LOAD SWITCH" in Page 15.

⑩ PRE OUT Switches

These switches are used to put ON and OFF the output signals from the PRE OUT Terminals 1 and 2.

To turn them ON, push them (), and to turn them OFF (), give another push.

⑩ BALANCE Control

Turning it to the right produces a decrease in the left channel sound volume, and turning to the left, a decrease in the right channel.

To bring the left and right channels in balance, push the "MONO" MODE switch and so adjust this knob that the sounds from the speakers, left and right, can be heard from the center position between them. Then, push the "STEREO" MODE switch.

CONNECTION OF AC POWER

Plug the power supply cord to an AC Socket outlet. When the amplifier is connected to a power amplifier and/or to a turntable, do not fail to fully turn the VOLUME switch to the left (∞) before switching power ON.

* Switching power ON makes the lamp housed in the switch button lighted. (Fig. 1)

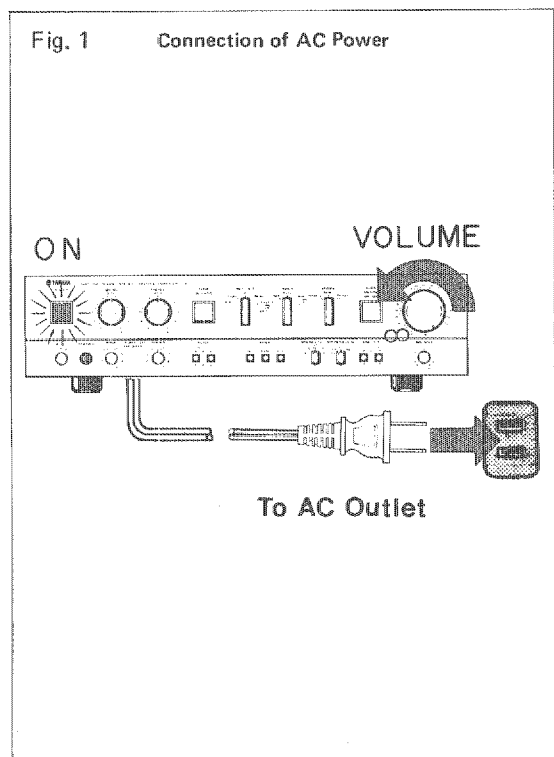

CONNECTION OF POWER AMPLIFIER

Connect the PRE OUT-1 terminals to the INPUT terminals on a power amplifier by means of connecting cords. Note that L and R are correctly connected as shown in Fig. 2.

CONNECTING A TURNTABLE UNIT

Three PHONO input terminals are provided for MM and MC cartridges.

Connect a turntable with MM (moving magnet) cartridge to the PHONO-1 and PHONO-2 terminals.

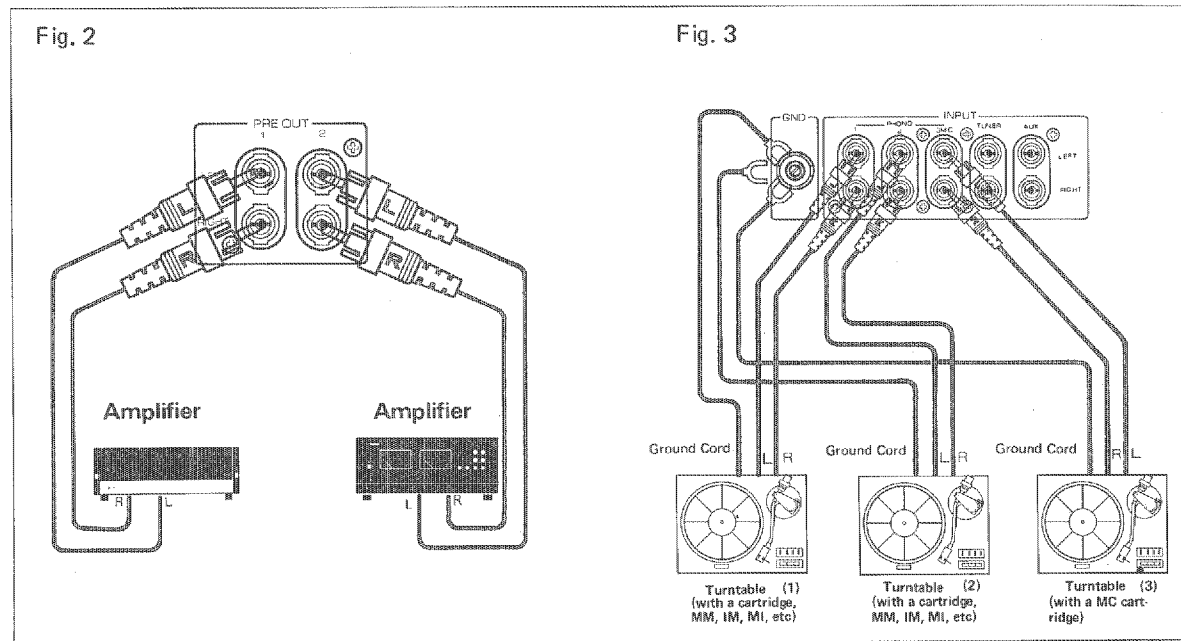

In case of MC (moving coil) cartridge, connect the output cord directly to the PHONO-3/MC terminals.

When connecting, confirm L and R of the pin plug provided at the tip of output cord from a turntable, and then connect a turntable with MM cartridge to the PHONO-1 or PHONO-2 terminal and a turntable with MC cartridge to the PHONO-3/MC terminal. (Fig. 3)

If a ground cord is provided together with the pin plug, connect it to the GND terminal on the rear panel.

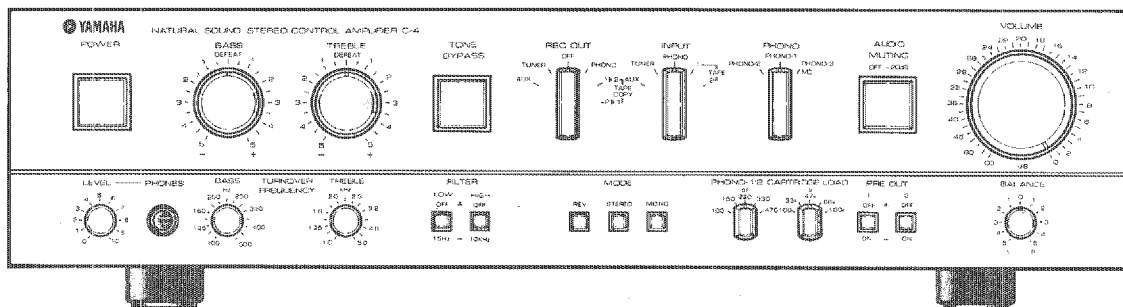

■ Playing DISC

- 1) Please note that connections are right.
- 2) Push the POWER switch "ON".
 - * The VOLUME control will be fully turned to the left (∞).
- 3) Set the PHONO INPUT selector switch on the front panel to the position corresponding to the input terminals to which the turntable is connected.
- * For example, set the PHONO INPUT selector switch to the "PHONO-1" position for the turntable connected to the PHONO-1 terminal.
- 4) Set the INPUT selector switch to "PHONO".
- 5) For a stereo disc, push the "STEREO" MODE switch, and for monaural disc, the "MONO" MODE switch.
- 6) Push the TONE BYPASS switch button if bypassing the tone control circuit is desired.
 - * In this case, all such controls in the control

circuit as BASS, TREBLE, and TURNOVER FREQUENCY BASS and TREBLE as well as LOW and HIGH FILTERS do not function.

- 7) Push the "1" or "2" PRE OUT switch button to select a power amplifier connected, and bring the amplifier into operation.
- 8) Commence DISC playing.
- 9) Turn the VOLUME slowly to the right and obtain desired sound volume. Also work on BALANCE control so that the sound volumes of left and right speakers are equal.
- 10) When using a MM cartridge on the turntable, set the " Ω " SWITCH of PHONO-1, -2 CARTRIDGE LOAD so as to best meet the cartridge's impedance. Also by means of the "pF" switch, select the optimum load capacity.

- 11) When the TONE BYPASS switch is left in the OFF position, the tone control circuit functions. So, use such controls at choice as BASS, TREBLE, and TURNOVER FREQUENCY BASS and TREBLE.

The FILTER circuit keeps also functioning, therefore cut off unwanted noise components by pushing the HIGH and/or LOW switch according to a disc program.

* Since the LOW switch is cut off ultra low frequency components below 15Hz out the audible range, you may leave it in the 15Hz position () so that it works as a subsonic filter.

- 12) When you discontinue disc play, turn the VOLUME control to the furthest left (∞), bring the disc play to a stop, and finally push the POWER switch OFF.

* The "pF" switch in PHONO-1, -2 CARTRIDGE LOAD presents stray capacity delicately varying according to length of the output cord of a turntable connected and with the material of the cord. In principle, use the " Ω " switch to achieve impedance matching for a cartridge to use, and use pF switch to make choice of a delicate tone variation in the high frequency range.

TUNER CONNECTION

Connect the tuner output terminals to the C-4 TUNER input terminals on the rear panel, using the pin-plug cord provided. Make sure to confirm that the left-hand and the right-hand outputs are connected to the proper input terminals. To enjoy your tuner, set the INPUT selector switch to TUNER position, and operate the tuner to receive the desired AM or FM signal. Then, follow the procedures 5) to 12) for playing DISC.

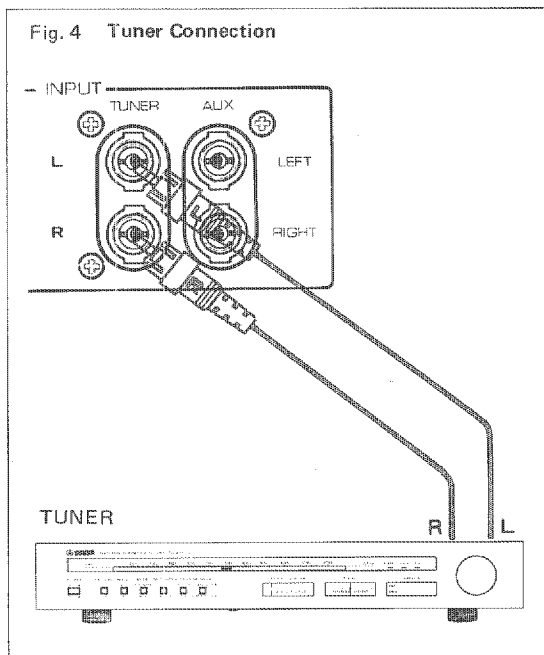

TAPE DECK CONNECTION/ PLAYBACK

The output cord provided with the Tape Deck are used to connect the deck LINE OUT terminals to the TAPE PB terminals. Use the TAPE 1 terminals for your main deck. Use the TAPE 2 terminals for a second deck or as a spare pair. Set the INPUT selector switch to TAPE 1 to play back tapes (or to TAPE 2 if you are using the TAPE 2 terminals, of course).

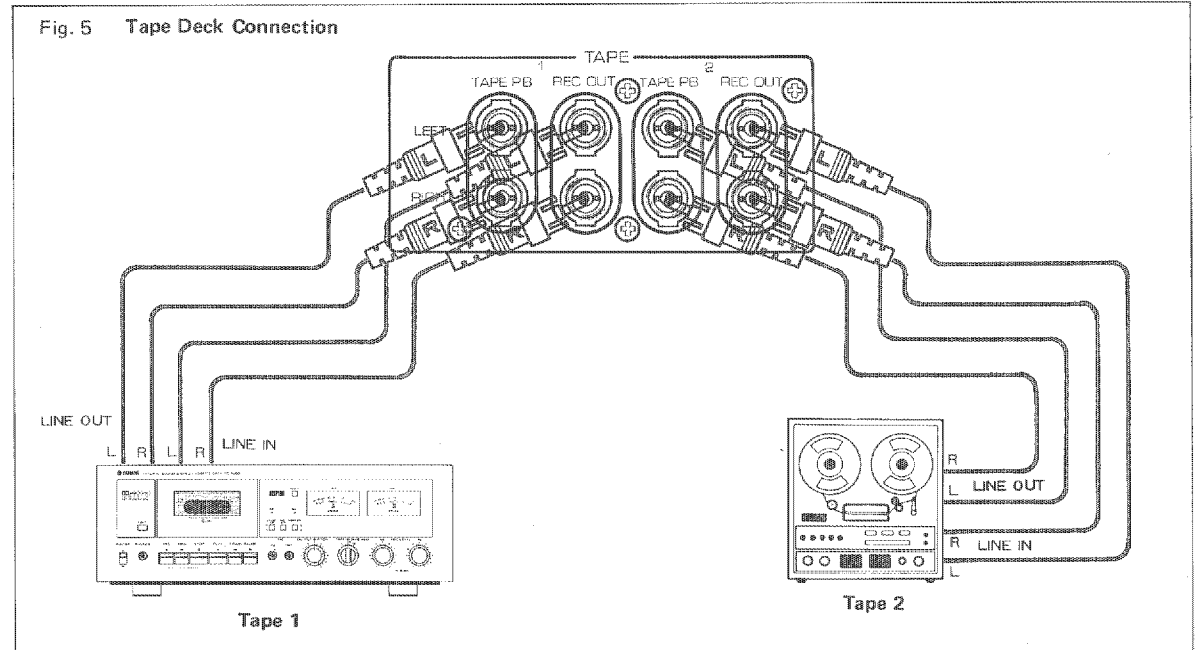

RECORDING

The tape-deck cord provided are used to connect the deck LINE IN terminals to the REC OUT terminals. Again, you should use the TAPE 1 terminals for your main deck, keeping the TAPE 2 terminals for a second or spare pair. Note that the INPUT selector switch setting has *no effect whatever* upon the signal which will be recorded via these terminals. The REC OUT terminals' signal is decided by the REC OUT selector switch.

REC OUT SELECTOR SWITCH

A program source from the REC OUT terminal can be recorded irrelevant to the program selected by the INPUT selector switch. For example, you can record an FM broadcast by placing the REC OUT selector switch in the TUNER position (Fig. 6) or dub a tape while listening to a disc through speaker.

Typical examples:

INPUT Selector Switch	REC OUT Selector Switch	Speakers
PHONO	TUNER	You can record an FM or AM broadcast while listening to a disc through speakers.
TUNER	TUNER	You can record an FM or AM broadcast while listening to it.
PHONO	PHONO	You can listen to a disc through speakers while recording it.
TUNER	PHONO	You can record a disc while listening to an FM or AM broadcast.

By matching other positions of the REC OUT and INPUT switches, you can enjoy various other program sources.

With the REC OUT selector switch in the OFF position, the C-4 is completely disconnected from the recording output terminals. Thus, when you are not recording, the C-4 will be protected from any adverse effects of unused tape deck input circuit impedances. Use this position when not recording.

Recording One Program Source While Listening to Another

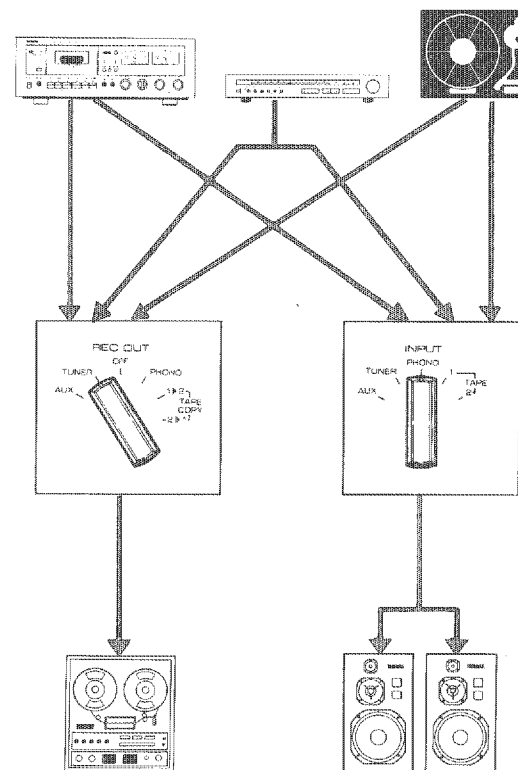
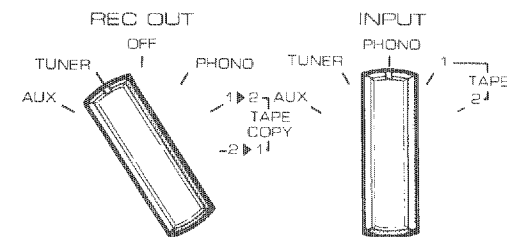

Fig. 6 Rec Out Selector & Input Selector Setting



TAPE DUBBING (TAPE COPY)

The C-4 provides for dubbing from tape to tape with the tape decks 1 and 2 connected to the TAPE-1 and -2 terminals respectively. To dub from the tape deck 1 to the tape deck 2, place the REC OUT switch in the TAPE COPY 1 ► 2 position as shown in Fig. 6, and operate the tape deck 1 in the playback mode and the tape deck 2 in the recording mode.

* To dub from the TAPE-2 to the TAPE-1, place the REC OUT switch in the TAPE COPY 2 ► 1 position, and operate the tape decks 1 and 2 in the recording and playback modes respectively.

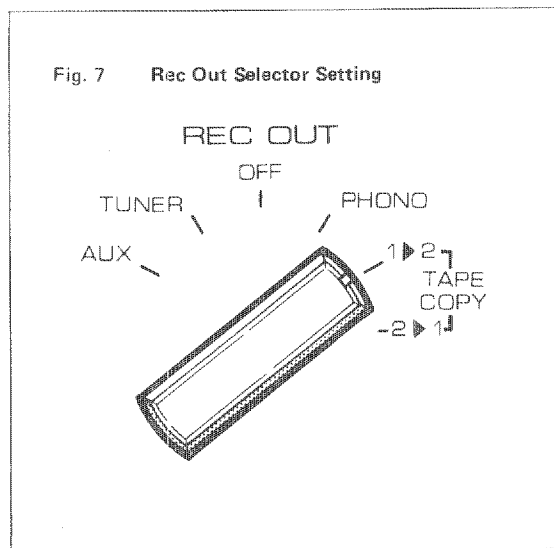

AUXILIARY INPUT CONNECTION

This is a spare input for any sound source you wish to connect to the C-4. When connecting a stereo source to these terminals, insure the left-hand and the right-hand plugs are inserted in the proper terminals.

This input has a sensitivity of 150mV, and can be used for such inputs as mic mixer amplifier, 8-track tape deck.

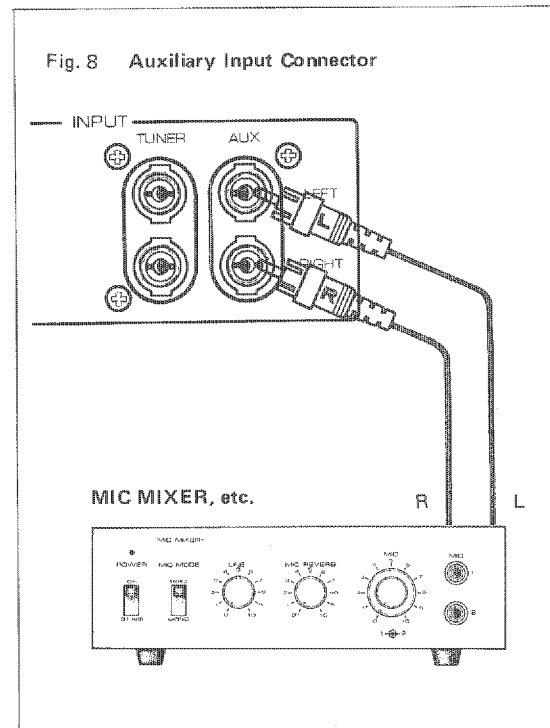

HEADPHONE

Plug the headphone into the headphone (PHONES) jack on the front panel. You can listen by headphone when the PRE OUT switch (1, 2) set to the OFF.

Please notice that the headphone's left and right are rightly on your ears when using it.

Adjust the LEVEL knob to control headphone level.

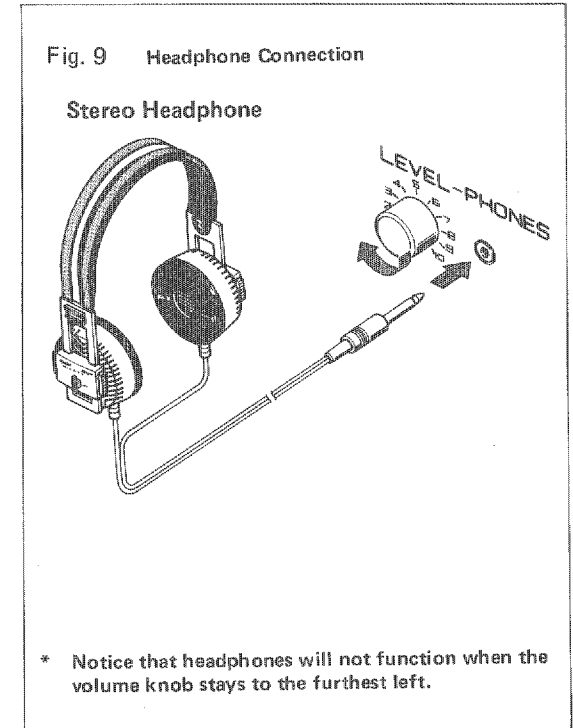

C-4

ADDITIONAL FUNCTIONS

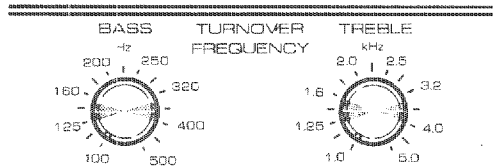
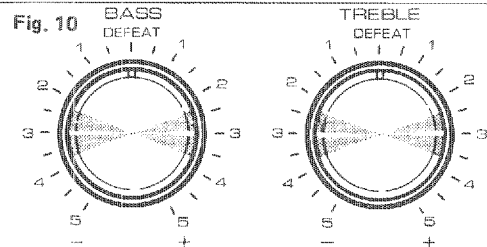

● BASS CONTROL CHARACTERISTICS

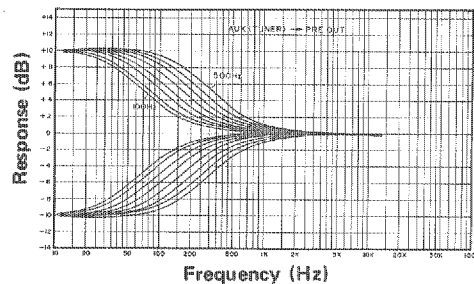

● TREBLE CONTROL CHARACTERISTICS

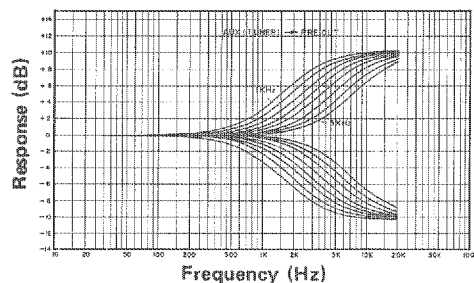

TONE CONTROLS/TURNOVER FREQUENCY CONTROLS

Sound quality considerably varies due to the conditions of a room where sound reproduction is made. These tone controls are the control circuits exclusively designed for compensating this sound quality according to your preference, in the low (BASS) and high (TREBLE) frequency ranges independently. (Fig. 10)

- BASS (Low Frequency Tone Control) can be achieved by means of the BASS control and the TURNOVER FREQUENCY BASS control.
 - The BASS control produces the greater volume increase in the low frequency the further it is turned to the right, and the greater decrease in the same the further it is turned to the left.
 - The TURNOVER FREQUENCY BASS control varies an turnover frequency in the range

from 100 to 500Hz. The further it is turned to the right, the greater increase in the turnover frequency is achieved, and the further it is turned to the left the greater decrease in the frequency is produced.

- TREBLE control..(high frequency tone control) can also be made in the same manner as BASS control. BASS and TREBLE variations effected by the controls are shown in Fig. 10. Once the TURNOVER FREQUENCY BASS and TREBLE controls are used, a greater change in the high and low frequency characteristics is produced for even the same extent of turning of the BASS and TREBLE controls. As above described, the C-4's tone control circuits make diversified and delicate tone control possible.

Fig. 11 Tone Bypass Switch

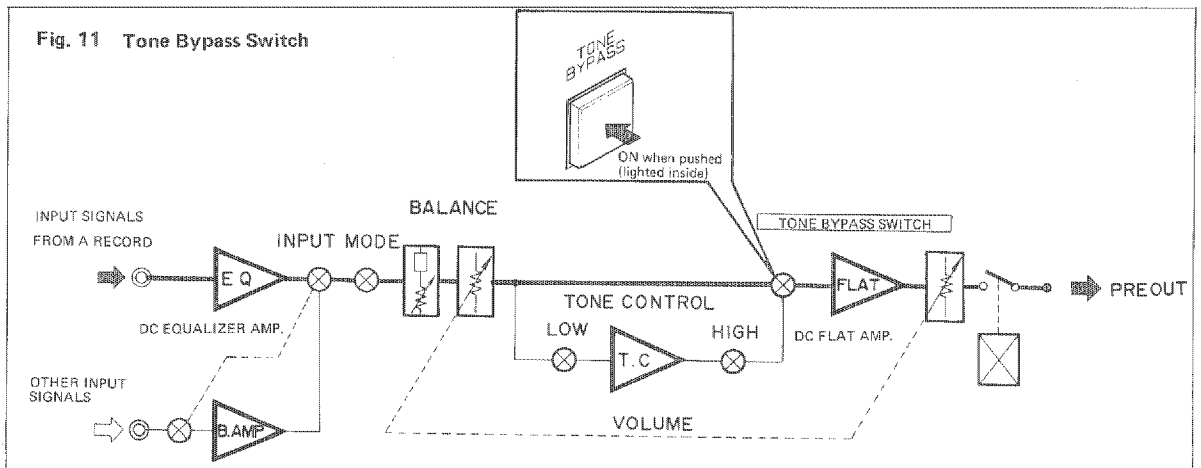

TONE BYPASS SWITCH

The TONE BYPASS switch is unique in that it directly connects the excellent equalizer amplifier and the DC flat amplifier.

As is shown in Fig. 11, when the TONE BYPASS switch is put ON (i.e. when the push-button is pushed and the lamp inside is lighted on), the output from the equalizer bypasses the tone controls and filter circuits and directly reaches the flat amplifier.

Thus, the output signals can be sent to the amplifier via the much simplified circuit configuration.

When two different program sources are connected to the amplifier and when two power amplifiers and/or two pairs of speakers are in use, this "TONE BYPASS" switch allows easy switching over for either flat characteristics or compensated tone characteristics at your option to better meet a program.

While the TONE BYPASS switch is ON (i.e. while the lamp lights on), neither the tone controls (BASS, TREBLE, TURNOVER FREQUENCY) nor the FILTER switches do function.

Here, also note that putting the TONE BYPASS switch OFF (i.e. putting the lamp off) badly influence the speakers when both the VOLUME control and the TURNOVER FREQUENCY BASS control are turned to the furthest right (i.e. fully clockwise) or when the LOW FILTER SWITCH is left in the OFF () position.

CARTRIDGE LOAD SWITCH

Generally speaking, the PHONO terminal of which input impedance fails to match the cartridge's load resistance value has bad influence upon the sound quality reproduced. The C-4 is equipped with the "Ω" SWITCH which can be switched over in five steps in all, 100Ω, 33kΩ, 47kΩ, 68kΩ, and 100kΩ, so as to fully meet the load resistance value of a cartridge in use. Changes in frequency characteristics effected by the switch is shown in Fig. 12. In addition, the "pF" SWITCH on the C-4 permits also five-step switching over the load capacity, i.e. 100pF, 150pF, 220pF, 330pF, and 470pF. Frequency characteristics changes due to positions of the switch are shown in Fig. 13.

* Due to the type of a cartridge in use, the amplifier's frequency characteristics vary to some extent. So, please choose such a switch position as to meet your preference in the tone quality. This switch further enables selection of the optimum stray capacity value or its compensation, of the output code connecting the cartridge and the PHONO input terminals. To achieve this selection or compensation, just follow and so set a load resistance value and turntable's cord capacity specified by the cartridge manufacturer. This capacity specification, however, may not be available in many cases. If not, please play a variety of discs to determine the optimum switch position to produce the type of sounds as you like.

This also means that using a load resistance value other than the manufacturer's specification on purpose makes creation of different sounds possible.

*1. Use a possibly shortest cord to connect a turntable and the amplifier. Also, use of a low capacity cord is recommended.

*2. The cartridge load of 100Ω represents a position for a low impedance high output MC cartridge.

*3. Please notice that cartridge load switching is impossible with the PHONO 3.

• IMPEDANCE SWITCHING-OVER & CARTRIDGE FREQUENCY CHARACTERISTICS

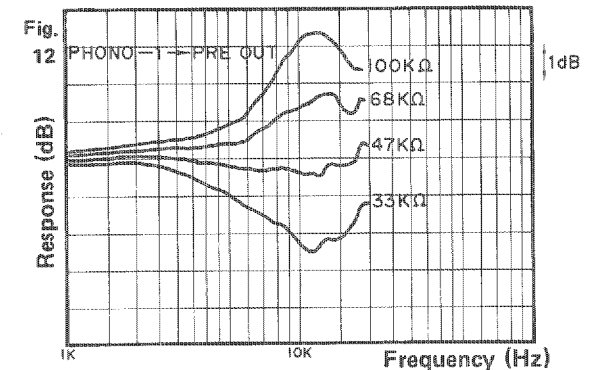

PHONO-1-2 Cartridge Load Switches

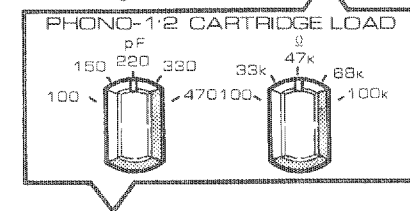

• CAPACITY SWITCHING-OVER & CARTRIDGE FREQUENCY CHARACTERISTICS

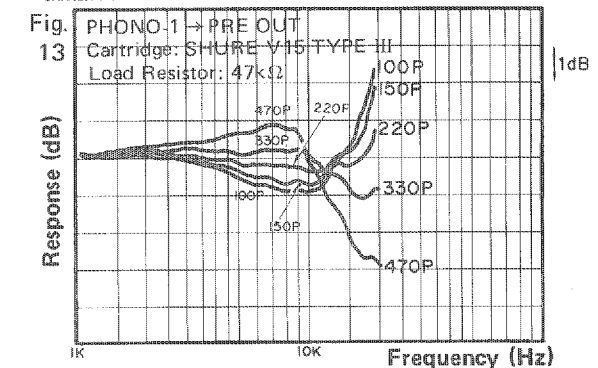

C-4

SPECIFICATIONS

Input Sensitivity/Impedance (1kHz)	
PHONO-1, 2	2.5mV/100Ω · 33kΩ · 47kΩ · 68kΩ · 100kΩ
	Capacitance: 100pF · 150pF · 220pF · 330pF
	470pF
PHONO-3/MC	100μV/50Ω
AUX, TUNER, TAPE PB-1, 2	150mV/47kΩ
Maximum Input Levels	
PHONO-1, 2	285mV at 0.01% T·H·D
PHONO-3/MC	10mV at 0.02% T·H·D
AUX, TUNER, TAPE PB-1, 2	8.2V at 0.01% T·H·D
Output Level/Impedance	
REC OUT 1, 2	150mV/180Ω
PRE OUT 1, 2	2.0V/600Ω
PHONES OUT	18V (at open load, 0.05% T·H·D) /330Ω
Maximum Output Level (20 to 20,000Hz)	
REC OUT 1, 2	15V (0.01% T·H·D)
PRE OUT 1, 2	10V (0.01% T·H·D)
PHONES OUT	18V (at open load)
Total Harmonic Distortion Ratio (20 to 20,000Hz)	
PHONO-1, 2 to PRE OUT-1, 2 (Vol. -30dB)	0.0035% (2V output)
PHONO-3/MC to PRE OUT-1, 2 (Vol. -30dB)	0.1% (2V output)
AUX, TUNER, TAPE PB-1, 2 to PRE OUT-1, 2 (Vol. max)	0.0035% (10V output)
PHONES OUT	0.02% (12mW, 8Ω)
IM Distortion Ratio	

AUX, TUNER, TAPE PB-1, 2 to PRE OUT-1, 2	
	0.005% (at 10V output)
Signal-to-Noise Ratio (IHF A-Network)	
	85dB (input shorted, rated output level)
PHONO-1, 2	73dB (input open, cart-ridge load: 47 kΩ rated output level)
PHONO-3/MC	77dB (input shorted, rated power)
AUX, TUNER, TAPE PB-1, 2	
- TONE BYPASS: ON -	106dB
- TONE BYPASS: OFF -	100dB
Residual Noise	0.2μV
Frequency Response	
RIAA Deviation	20 to 20,000Hz±0.2dB
AUX, TUNER, TAPE PB-1, 2	5 to 100kHz±0.5dB
Tone Control Characteristics	
Bass Turnover Frequency	100Hz to 500Hz
Bass Boost/Cut	±10dB at 20Hz
Treble Turnover Frequency	1kHz to 5kHz
Treble Boost/Cut	±10dB at 20kHz
Filter Characteristics	
LOW FILTER	15Hz, 12dB/oct
HIGH FILTER	10kHz, 12dB/oct
Channel Separation	
PHONO-1, 2 to PRE OUT-1, 2	85dB (Vol. -30dB · 1kHz · 5.1kΩ shorted)
PHONO-3/MC to PRE OUT-1, 2	85dB (Vol. -30dB · 1kHz · 0Ω shorted)

AUX, TUNER, TAPE PB-1, 2 to PRE OUT 1, 2	
	85dB (Vol. -30dB · 1kHz·5.1kΩ shorted)
Audio Muting	-20dB
GENERAL	
Power Supply	120V AC, 60Hz
Power Consumption	50W
Dimensions (WxHxD)	435x116x376mm (17-1/8")x(4-1/2")x(14-3/4")
Weight	8.6kg (18 lb 15 oz)

Specifications subject to change without notice.

G-4

BLOCK DIAGRAM

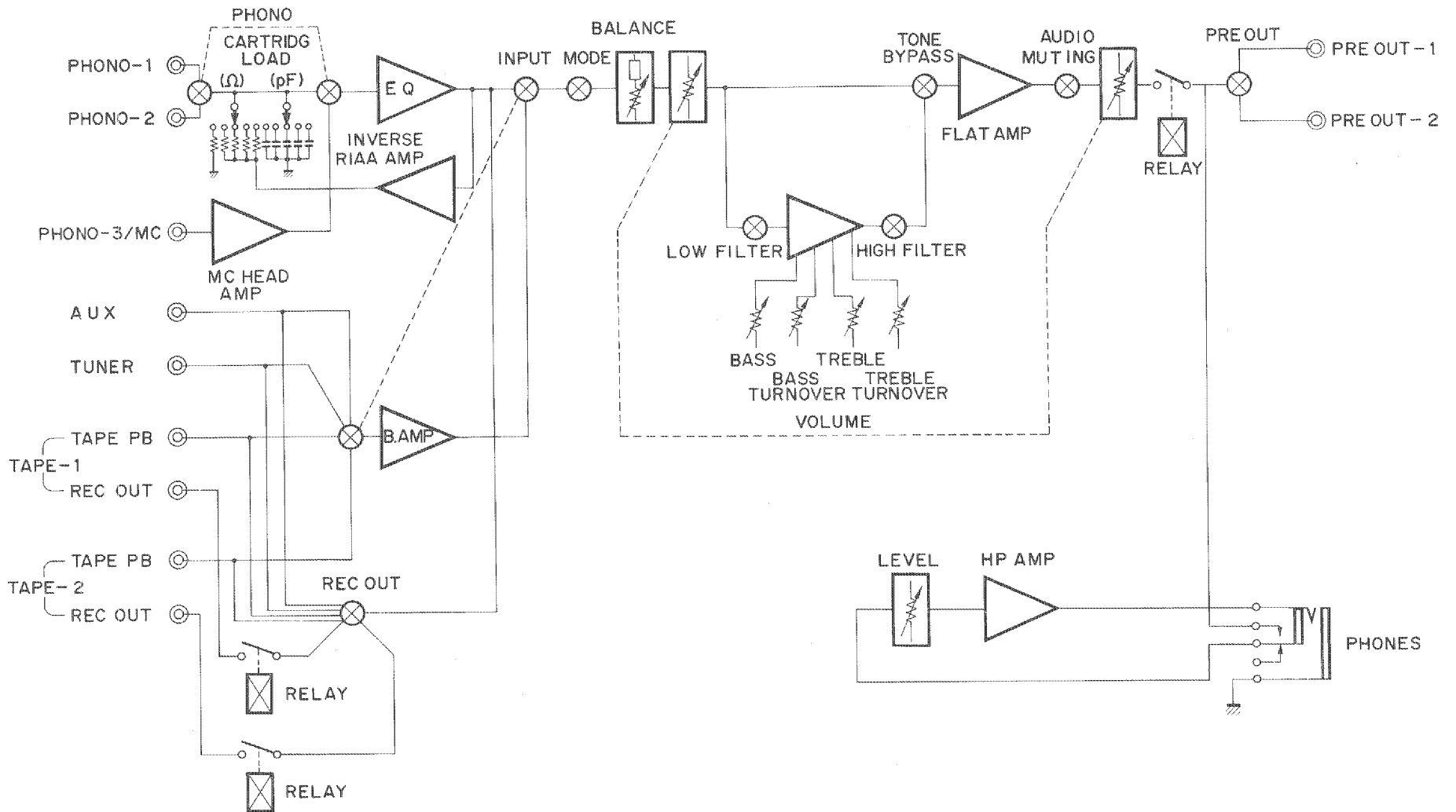

G-4

TROUBLE SHOOTING

Fault	Cause	Cure
No power although POWER switch is ON.	AC power line not plugged into supply socket.	Plug it firmly into the supply socket.
	Power remains off despite of AC supply through firm connection.	Contact your nearest YAMAHA dealer.
No sound although INPUT switch is ON.	INPUT selector switch in wrong position.	Check and change as necessary.
	VOLUME too low.	Turn up VOLUME.
	INPUT pin plug incorrectly inserted.	Check and insert it fully in correct position.
	OUTPUT cord's defective connection.	Check and make good.
	PRE OUT switch in OFF position.	Set REC OUT switch to ON position.
No sound from both speakers, or sound only from either L or R speaker.	Defective connections between control- and power-amplifiers, or between power amp. and speakers.	Perform correct connections, or check operations.
	Balance control not properly adjusted.	Set it for correct stereo balance.
Sound suddenly ceases during audition.	Speaker protection circuit (on power amp.) at work, having detected over $\pm 2V$ DC at speaker terminals.	Power amp.'s potential lowering to 0V, relay operates to lead to speakers. Turn power amp.'s power switch OFF, and a short time after turn it back ON.
	Trouble with circuit itself.	Contact your nearest YAMAHA dealer.
Poor bass response and inferior stereo image.	Adversely connected phase polarity (+, -) between power amp. and speakers.	Achieve correct connections.
Sufficient volume unobtainable through VOLUME control.	AUDIO MUTING switch remains ON.	Switch it OFF and readjust VOLUME.
Loud 'humming' occurs during record audition.	Defective connection of PIN PLUG.	Plug it in firmly.
	Turntable's ground cord not connected to amp.'s GND terminal.	Connect ground cord to GND terminal on rear panel.
Reception of amateur or private station mixed with desired reception.	Such stations located in vicinity.	Consult with your YAMAHA dealer.
		Consult with such stations.
Loud 'howling' noise when raising VOLUME during record audition.	Speakers and turntable are positioned closely.	Give a proper space between speakers and turntable.
MC cartridge delivers low sound volume.	MC cartridge output cord connected to MM terminal (PHONO-1, 2)	Connect it to MC terminal (PHONO-3/MC)
Bass and treble controls have no effect.	TONE BYPASS switch remains ON (lamp is lit).	Turn switch OFF, as it is left ON (lighted) tone control and filter circuit are not operative.
FILTER switch has no effect.		

SINCE 1887



YAMAHA

NIPPON GAKKI CO., LTD. HAMAMATSU, JAPAN