



AV Receiver

HTR-3067

Owner's Manual

Read the supplied booklet "Safety Brochure" before using the unit.

English

CONTENTS

| | |
|-------------------|---|
| Accessories | 4 |
|-------------------|---|

FEATURES 5

| | |
|-------------------------------------|---|
| What you can do with the unit | 5 |
|-------------------------------------|---|

| | |
|--------------------------------|---|
| Part names and functions | 7 |
|--------------------------------|---|

| | |
|----------------------------------|----|
| Front panel | 7 |
| Front display (indicators) | 8 |
| Rear panel | 9 |
| Remote control | 10 |

PREPARATIONS 11

| | |
|-------------------------------|----|
| General setup procedure | 11 |
|-------------------------------|----|

| | |
|--------------------------|----|
| 1 Placing speakers | 12 |
|--------------------------|----|

| | |
|-----------------------------|----|
| 2 Connecting speakers | 15 |
|-----------------------------|----|

| | |
|-------------------------------------|----|
| Input/output jacks and cables | 17 |
|-------------------------------------|----|

| | |
|-------------------------|----|
| 3 Connecting a TV | 18 |
|-------------------------|----|

| | |
|-------------------------------------|----|
| 4 Connecting playback devices | 20 |
|-------------------------------------|----|

| | |
|---|----|
| Connecting video devices (such as BD/DVD players) | 20 |
| Connecting audio devices (such as CD players) | 22 |
| Connecting to the jack on the front panel | 23 |

| | |
|---------------------------------------|----|
| 5 Connecting the FM/AM antennas | 23 |
|---------------------------------------|----|

| | |
|--------------------------------------|----|
| 6 Connecting recording devices | 24 |
|--------------------------------------|----|

| | |
|------------------------------------|----|
| 7 Connecting the power cable | 24 |
|------------------------------------|----|

| | |
|--|----|
| 8 Selecting an on-screen menu language | 25 |
|--|----|

| | |
|--|----|
| 9 Optimizing the speaker settings automatically (YPAO) | 26 |
|--|----|

| | |
|------------------------|----|
| Error messages | 28 |
| Warning messages | 29 |

PLAYBACK 30

| | |
|--------------------------------|----|
| Basic playback procedure | 30 |
|--------------------------------|----|

| | |
|--|----|
| Switching information on the front display | 30 |
|--|----|

| | |
|---|--|
| Selecting the input source and favorite settings with one touch | |
|---|--|

| | |
|---------------|----|
| (SCENE) | 31 |
|---------------|----|

| | |
|-------------------------------------|----|
| Configuring scene assignments | 31 |
|-------------------------------------|----|

| | |
|--------------------------------|----|
| Selecting the sound mode | 32 |
|--------------------------------|----|

| | |
|---|----|
| Enjoying sound field effects (CINEMA DSP) | 33 |
| Enjoying unprocessed playback | 35 |
| Enhancing the bass (Extra Bass) | 36 |
| Enjoying compressed music with enhanced sound (Compressed Music Enhancer) | 36 |

| | |
|--------------------------------|----|
| Listening to FM/AM radio | 37 |
|--------------------------------|----|

| | |
|---|----|
| Setting the frequency steps | 37 |
| Selecting a frequency for reception | 37 |
| Registering favorite radio stations (presets) | 38 |
| Radio Data System tuning | 40 |

| | |
|-------------------------------|----|
| Playing back iPod music | 41 |
|-------------------------------|----|

| | |
|--------------------------------|----|
| Connecting an iPod | 41 |
| Playback of iPod content | 41 |

| | |
|---|----|
| Playing back music stored on a USB storage device | 45 |
|---|----|

| | |
|---|----|
| Connecting a USB storage device | 45 |
| Playback of USB storage device contents | 45 |

| | |
|--|--|
| Configuring playback settings for different playback sources | |
|--|--|

| | |
|---------------------|----|
| (Option menu) | 48 |
|---------------------|----|

| | |
|-------------------------|----|
| Option menu items | 48 |
|-------------------------|----|

CONFIGURATIONS 51

| | |
|--|-----------|
| Configuring various functions (Setup menu) | 51 |
| Setup menu items | 52 |
| Speaker | 54 |
| HDMI | 57 |
| Sound | 59 |
| ECO | 61 |
| Function | 62 |
| Language | 63 |
| Configuring the system settings (ADVANCED SETUP menu) | 64 |
| ADVANCED SETUP menu items | 64 |
| Changing the speaker impedance setting (SP IMP.) | 64 |
| Selecting the remote control ID (REMOTE ID) | 65 |
| Changing the FM/AM tuning frequency setting (TU) | 65 |
| Switching the video signal type (TV FORMAT) | 65 |
| Restoring the default settings (INIT) | 65 |
| Updating the firmware (UPDATE) | 66 |
| Checking the firmware version (VERSION) | 66 |

APPENDIX 67

| | |
|---|-----------|
| Frequently asked questions | 67 |
| Troubleshooting | 68 |
| Power, system and remote control | 68 |
| Audio | 69 |
| Video | 70 |
| FM/AM radio | 71 |
| USB | 71 |
| Error indications on the front display | 72 |
| Glossary | 73 |
| Audio information | 73 |
| HDMI and video information | 74 |

| | |
|---|-----------|
| Yamaha technologies | 74 |
| Supported devices and file formats | 75 |
| Video signal flow | 75 |
| Information on HDMI | 76 |
| HDMI Control | 76 |
| Audio Return Channel (ARC) | 77 |
| HDMI signal compatibility | 78 |
| Reference diagram (rear panel) | 79 |
| Trademarks | 80 |
| Specifications | 81 |
| Index | 83 |

Accessories

Check that the following accessories are supplied with the product.

Remote control



Batteries (AAA, R03, UM-4) (x2)

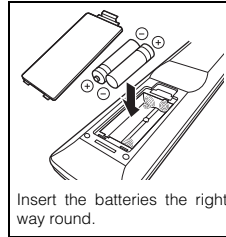
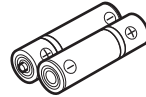

AM antenna



FM antenna

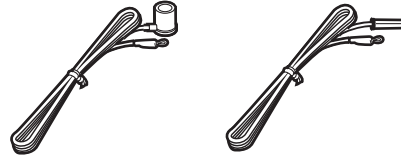

*One of the above is supplied depending on the region of purchase.

YPAO microphone

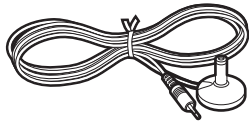

CD-ROM (Owner's Manual)



Easy Setup Guide

Safety Brochure

Operating range of the remote control

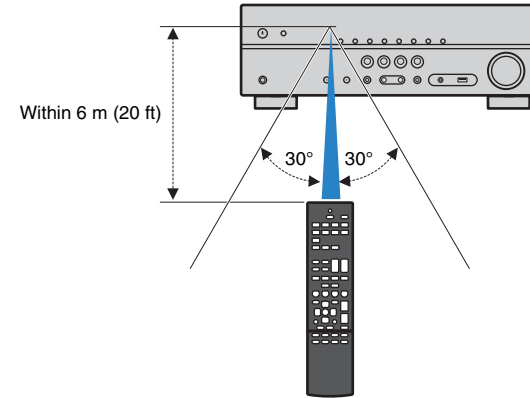
- Point the remote control at the remote control sensor on the unit and remain within the operating range shown below.



- Some features are not available in certain regions.
- Due to product improvements, specifications and appearance are subject to change without notice.
- This manual explains operations using the supplied remote control.
- This manual describes both the "iPod" and "iPhone" as the "iPod". "iPod" refers to both "iPod" and "iPhone", unless otherwise specified.
-  indicates precautions for use of the unit and its feature limitations.
-  indicates supplementary explanations for better use.

FEATURES

What you can do with the unit

- High-quality sound from iPod via digital connection ➔ p.41
- Playback of music stored on USB storage devices ➔ p.45



iPod



USB storage device

Audio

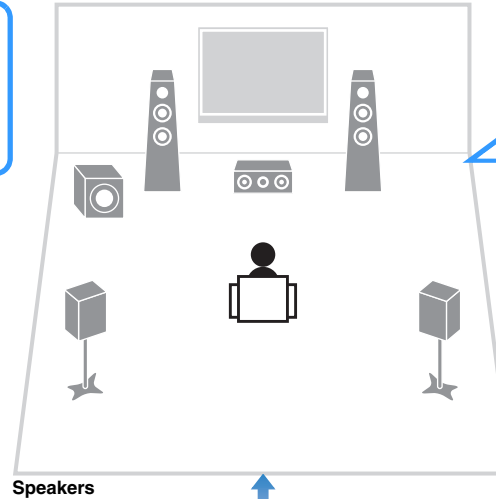

Speakers

Audio

Supports 2- to 5.1-channel speaker system. Allows you to enjoy your favorite acoustic spaces in various styles.

- Automatically optimizing the speaker settings to suit your room (YPAO) ➔ p.26
- Reproducing stereo or multichannel sounds with the sound fields like actual movie theaters and concert halls (CINEMA DSP) ➔ p.33
- Enjoying compressed music with enhanced sound (Compressed Music Enhancer) ➔ p.36

3D and 4K Ultra HD signals supported

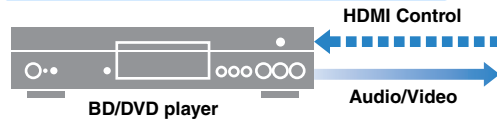

BD/DVD player

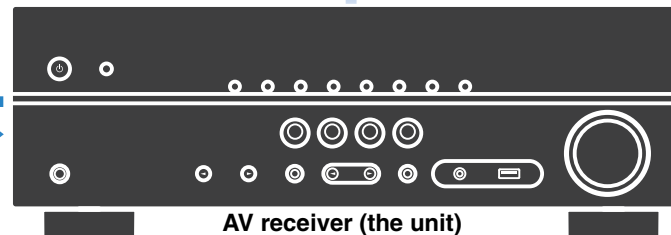

AV receiver (the unit)

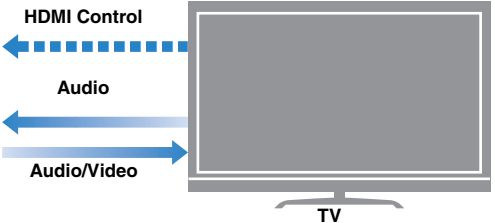

TV

The ECO mode (power saving function) allows you to create an eco-friendly home theater system

➔ p.61



The unit's remote control

Change the input source and favorite settings with one touch (SCENE)

➔ p.31



TV remote control

Sequential operation of a TV, AV receiver, and BD/DVD player (HDMI Control)

➔ p.76

Full of useful functions!

❑ Connecting various devices (p.20)

A number of HDMI jacks and various input/output jacks on the unit allow you to connect video devices (such as BD/DVD players), audio devices (such as CD players), game consoles, portable audio player, and other devices.

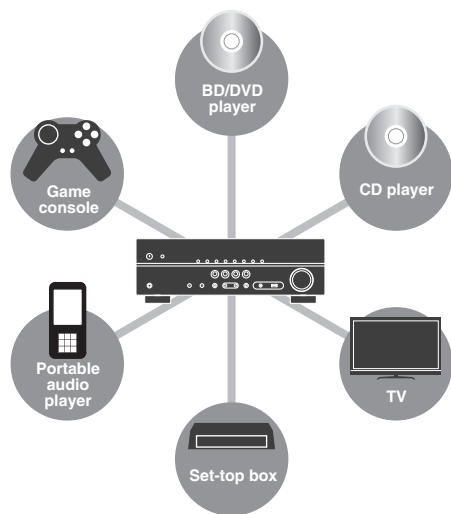

❑ Playing back TV audio in surround sound with a single HDMI cable connection (Audio Return Channel: ARC) (p.18)

When using an ARC-compatible TV, you only need one HDMI cable to enable video output to the TV, audio input from the TV, and the transmission of HDMI Control signals.

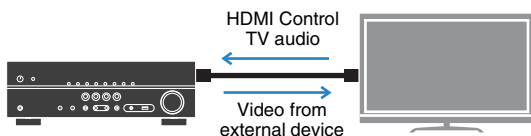

❑ Creating high-realistic sound fields (p.33)

CINEMA DSP allows you to create a natural and realistic sound field in your own room.

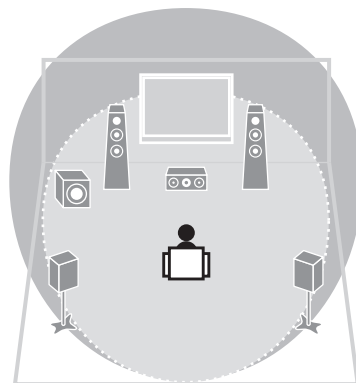

❑ Surround playback with 5 speakers placed in front (p.34)

You can enjoy the surround sound even when the surround speakers are placed in front.

❑ Enhanced bass reproduction (p.36)

Extra Bass allows you to enjoy enhanced bass reproduction that does not depend on the speakers used.

❑ Listening to FM/AM radio (p.37)

The unit is equipped with a built-in FM/AM tuner. You can register up to 40 favorite radio stations as presets.

❑ Easy operation with a TV screen

You can operate the iPod or USB storage device, view information, or easily configure the settings using the on-screen menu.

Useful tips

The combination of video/audio input jacks does not match an external device...

Use "Audio In" in the "Option" menu to change the combination of video/audio input jacks so that it matches the output jack(s) of your external device (p.21).

Video and audio are not synchronized...

Use "Lipsync" in the "Setup" menu to adjust the delay between video and audio output (p.59).

I want to hear audio from the TV speakers...

Use "Audio Output" in the "Setup" menu to select the output destination of signals input into the unit (p.57). Your TV speakers may be selected as an output destination.

I want to change the on-screen menu language...

Use "Language" in the "Setup" menu to select a language from English, Japanese, French, German, Spanish, Russian, Italian and Chinese (p.25).

I want to update the firmware...

Use "UPDATE" in the "ADVANCED SETUP" menu to update the unit's firmware (p.66).

Many other settings are available that let you to customize the unit. For details, see the following pages.

- SCENE settings (p.31)
- Sound/video settings and signal information for each source (p.48)
- Various function settings (p.52)
- System settings (p.64)

Part names and functions

Front panel

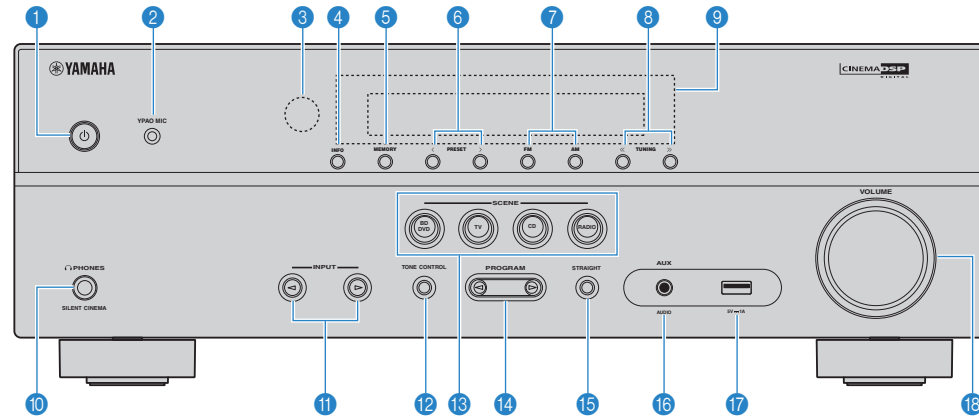

1 **⏻ (power) key**

Turns on/off (standby) the unit.

2 **YPAO MIC jack**

For connecting the supplied YPAO microphone (p.26).

3 **Remote control sensor**

Receives remote control signals (p.4).

4 **INFO key**

Selects the information displayed on the front display (p.30).

5 **MEMORY key**

Registers FM/AM radio stations as preset stations (p.38).

6 **PRESET keys**

Select a preset FM/AM radio station (p.39).

7 **FM and AM keys**

Switch between FM and AM (p.37).

8 **TUNING keys**

Select the radio frequency (p.37).

9 **Front display**

Displays information (p.8).

10 **PHONES jack**

For connecting headphones.

11 **INPUT keys**

Select an input source.

12 **TONE CONTROL key**

Adjusts the high-frequency range and low-frequency range of output sounds (p.49).

13 **SCENE keys**

Select the registered input source and sound program with one touch. Also, turns on the unit when it is in standby mode (p.31).

14 **PROGRAM keys**

Select a sound program or a surround decoder (p.32).

15 **STRAIGHT key**

Enables/disables the straight decode mode (p.35).

16 **AUX jack**

For connecting devices, such as portable audio players (p.23).

17 **USB jack**

For connecting a USB storage device (p.45) or an iPod (p.41).

18 **VOLUME knob**

Adjusts the volume.

Front display (indicators)

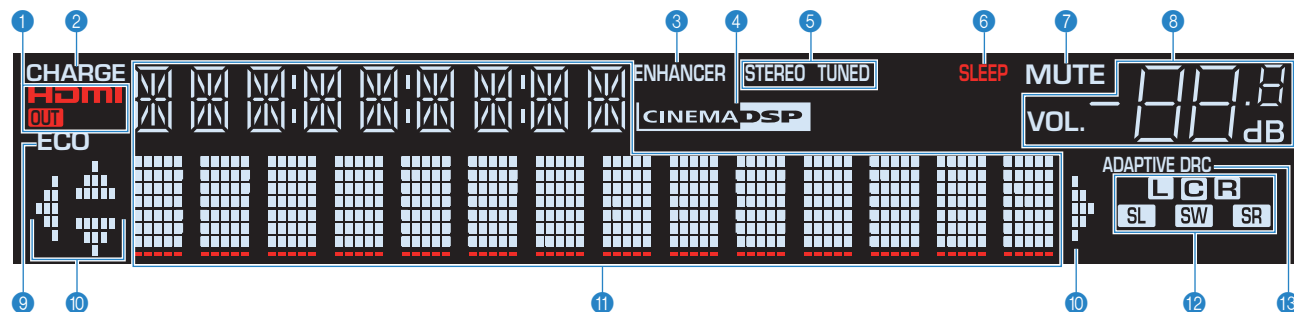

1 HDMI

Lights up when HDMI signals are being input or output.

OUT

Lights up when HDMI signals are being output.

2 CHARGE

Lights up when the iPod is being charged while the unit is in standby mode (p.41).

3 ENHANCER

Lights up when Compressed Music Enhancer (p.36) is working.

4 CINEMA DSP

Lights up when CINEMA DSP (p.33) is working.

5 STEREO

Lights up when the unit is receiving a stereo FM radio signal.

TUNED

Lights up when the unit is receiving an FM/AM radio station signal.

6 SLEEP

Lights up when the sleep timer is on.

7 MUTE

Blinks when audio is muted.

8 Volume indicator

Indicates the current volume.

9 ECO

Lights up when the eco mode (p.61) is enabled.

10 Cursor indicators

Indicate the remote control cursor keys currently operational.

11 Information display

Displays the current status (such as input name and sound mode name). You can switch the information by pressing INFO (p.30).

12 Speaker indicators

Indicate speaker terminals from which signals are output.

L Front speaker (L)

R Front speaker (R)

C Center speaker

SL Surround speaker (L)

SR Surround speaker (R)

SW Subwoofer

13 ADAPTIVE DRC

Lights up when Adaptive DRC (p.49) is working.

Rear panel

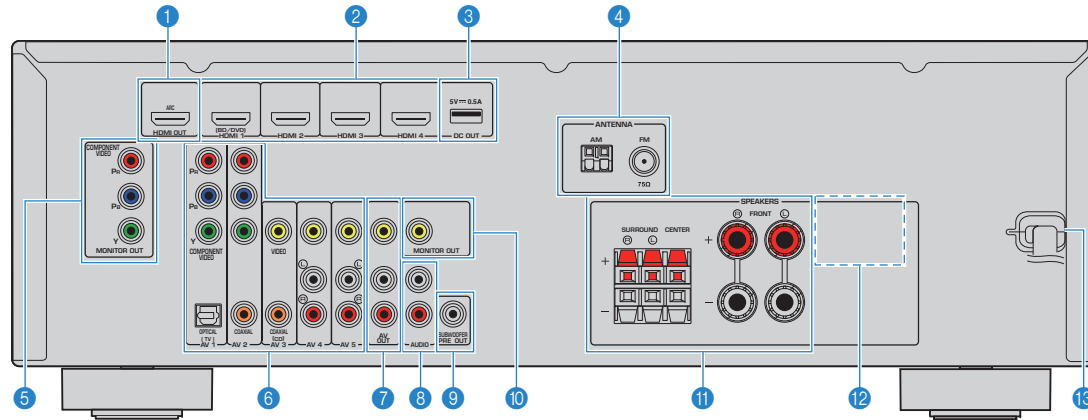

* The area around the video/audio output jacks is marked in white on the actual product to prevent improper connections.

1 HDMI OUT jack

For connecting to an HDMI-compatible TV and outputting video/audio signals (p.18). When using ARC, TV audio signal can also be input through the HDMI OUT jack.

2 HDMI 1–4 jacks

For connecting to HDMI-compatible playback devices and inputting video/audio signals (p.20).

3 DC OUT jack

For supplying power to a Yamaha AV accessory. For details on connections, refer to the instruction manual of the AV accessory.

4 ANTENNA jacks

For connecting to FM and AM antennas (p.23).

5 MONITOR OUT (component video) jacks

For connecting to a TV that supports component video and outputting video signals (p.18).

6 AV 1–5 jacks

For connecting to video/audio playback devices and inputting video/audio signals (p.20).

7 AV OUT jacks

For outputting video/audio to a recording device (such as a VCR) (p.24).

8 AUDIO jacks

For connecting to audio playback devices and inputting audio signals (p.22).

9 SUBWOOFER PRE OUT jack

For connecting to a subwoofer (with built-in amplifier) (p.15).

10 MONITOR OUT (composite video) jack

For connecting to a TV that supports composite video and outputting video signals (p.18).

11 SPEAKERS terminals

For connecting to speakers (p.15).

12 VOLTAGE SELECTOR

(Taiwan and General models only)
Selects the switch position according to your local voltage (p.24).

13 Power cable

For connecting to an AC wall outlet (p.24).

Remote control

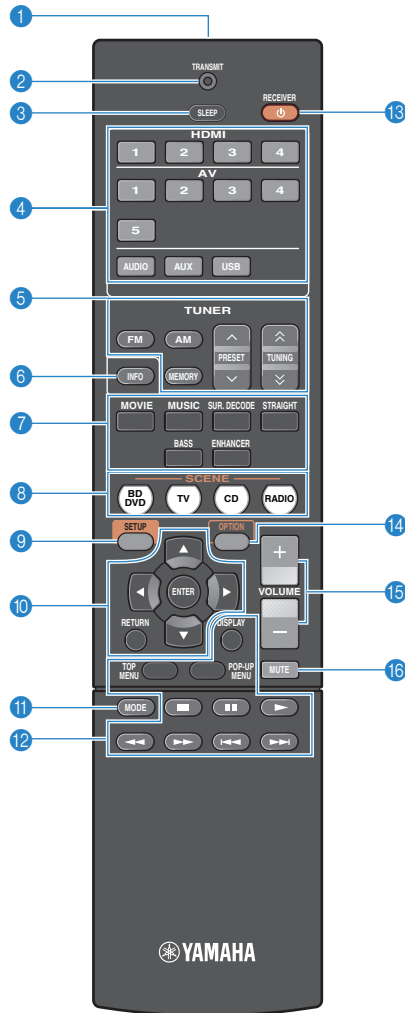

1 Remote control signal transmitter

Transmits infrared signals.

2 TRANSMIT indicator

Lights up when remote control signals are transmitted.

3 SLEEP key

Switches the unit to standby mode automatically after a specified period of time has elapsed (sleep timer). Press repeatedly to set the time (120 min, 90 min, 60 min, 30 min, off).

4 Input selection keys

Select an input source for playback.

| | |
|-----------------|-------------------------------|
| HDMI 1–4 | HDMI 1–4 jacks |
| AV 1–5 | AV 1–5 jacks |
| AUDIO | AUDIO jacks |
| AUX | AUX jack (on the front panel) |
| USB | USB jack (on the front panel) |

5 Radio keys

Operate the FM/AM radio (p.37).

| | |
|---------------|--|
| FM | Switches to FM radio. |
| AM | Switches to AM radio. |
| MEMORY | Registers FM/AM radio stations as presets. |
| PRESET | Select a preset station. |
| TUNING | Select the radio frequency. |

6 INFO key

Selects the information displayed on the front display (p.30).

7 Sound mode keys

Select a sound mode (p.32).

8 SCENE keys

Select the registered input source and sound program with one touch. Also, turns on the unit when it is in standby mode (p.31).

9 SETUP key

Displays the setup menu (p.51).

10 Menu operation keys

| | |
|--------------------|---------------------------------|
| Cursor keys | Select a menu or a parameter. |
| ENTER | Confirms a selected item. |
| RETURN | Returns to the previous screen. |

11 MODE key

Switches between "Stereo" and "Mono" for FM radio reception (p.37).
Switches the iPod operation modes (p.43).

12 External device operation keys

Control playback of the iPod (p.41) or USB storage device (p.45).
Also control playback or operate menus of the playback devices connected to the unit with an HDMI cable.



• The playback devices must support HDMI Control. However, Yamaha does not assure the operation of all HDMI Control-compatible devices.

13 RECEIVER key

Turns on/off (standby) the unit.

14 OPTION key

Displays the option menu (p.48).

15 VOLUME keys

Adjust the volume.

16 MUTE key

Mutes the audio output.

PREPARATIONS

General setup procedure

- 1 Placing speakers (p.12)** Select the speaker layout for the number of speakers that you are using and place them in your room.
- 2 Connecting speakers (p.15)** Connect the speakers to the unit.
- 3 Connecting a TV (p.18)** Connect a TV to the unit.
- 4 Connecting playback devices (p.20)** Connect video devices (such as BD/DVD players) and audio devices (such as CD players) to the unit.
- 5 Connecting the FM/AM antennas (p.23)** Connect the supplied FM/AM antennas to the unit.
- 6 Connecting recording devices (p.24)** Connect recording devices to the unit.
- 7 Connecting the power cable (p.24)** After all the connections are complete, plug in the power cable.
- 8 Selecting an on-screen menu language (p.25)** Select the desired on-screen menu language.
- 9 Optimizing the speaker settings automatically (YPAO) (p.26)** Optimize the speaker settings, such as volume balance and acoustic parameters, to suit your room (YPAO).

This completes all the preparations. Enjoy playing movies, music, radio and other content with the unit!

1 Placing speakers

Select the speaker layout for the number of speakers that you are using and place the speakers and subwoofer in your room. This section describes the representative speaker layout examples.

Caution

- (U.S.A. and Canada models only)
Under its default settings, the unit is configured for 8-ohm speakers. When connecting 6-ohm speakers, set the unit's speaker impedance to "6 Ω MIN". For details, see "Setting the speaker impedance" (p.14).
- (Except for U.S.A. and Canada models)
Use speakers with an impedance of at least 6 Ω.

| Speaker type | Abbr. | Function | Speaker system (the number of channels) | | | | |
|--------------|-----------|---|---|----------------------------|-----|-----|-----|
| | | | 5.1 | 5.1 (Virtual CINEMA FRONT) | 4.1 | 3.1 | 2.1 |
| Front (L) | FL | Produce front right/left channel sounds (stereo sounds). | ● | ● | ● | ● | ● |
| Front (R) | FR | | ● | ● | ● | ● | ● |
| Center | C | Produces center channel sounds (such as movie dialogue and vocals). | ● | ● | | ● | |
| Surround (L) | SL | Produce surround right/left channel sounds. | ● | ●* | ● | | |
| Surround (R) | SR | | ● | ●* | ● | | |
| Subwoofer | SW | Produces LFE (low-frequency effect) channel sounds and reinforces the bass parts of other channels. This channel is counted as "0.1". | ● | ● | ● | ● | ● |

* Place the surround speakers in front and set "Virtual CINEMA FRONT" (p.55) in the "Setup" menu to "On".

5.1-channel system

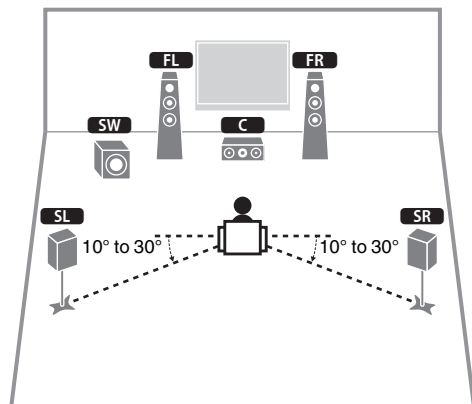

4.1-channel system

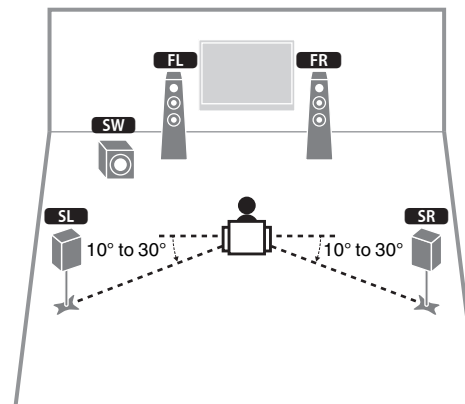

5.1-channel system (Virtual CINEMA FRONT)

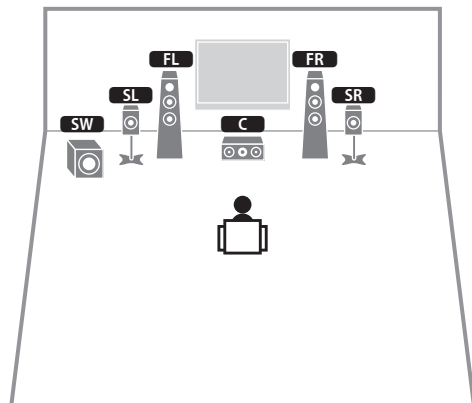

3.1-channel system

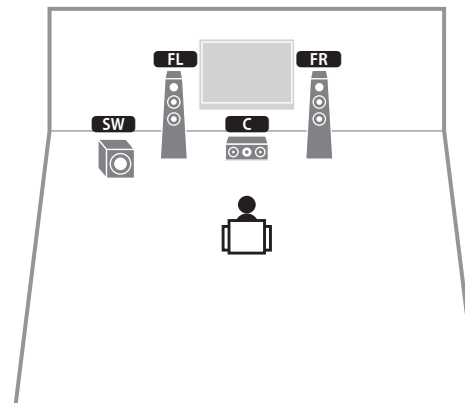

- To utilize this configuration, set "Virtual CINEMA FRONT" (p.55) in the "Setup" menu to "On".



- You can enjoy surround sound even without the center speaker (front 4.1-channel system).

2.1-channel system

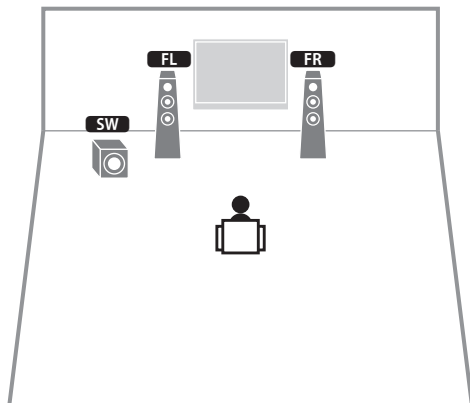

■ Setting the speaker impedance

(U.S.A. and Canada models only)

Under its default settings, the unit is configured for 8-ohm speakers. When connecting 6-ohm speakers, set the speaker impedance to "6 Ω MIN".

- 1** Before connecting speakers, connect the power cable to an AC wall outlet.
- 2** While holding down STRAIGHT on the front panel, press  (power).

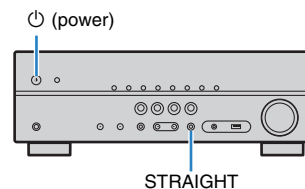

- 3** Check that "SP IMP." is displayed on the front display.



- 4** Press STRAIGHT to select "6 Ω MIN".
- 5** Press  (power) to set the unit to standby mode and remove the power cable from the AC wall outlet.
You are now ready to connect the speakers.

2 Connecting speakers

Connect the speakers placed in your room to the unit. The following diagrams provide connections for a 5.1-channel system as an example. For other systems, connect speakers while referring to the connection diagram for the 5.1-channel system.

Caution

- Remove the unit's power cable from an AC wall outlet and turn off the subwoofer before connecting the speakers.
- Ensure that the core wires of the speaker cable do not touch one another or come into contact with the unit's metal parts. Doing so may damage the unit or the speakers. If the speaker cables short circuit, "Check SP Wires" will appear on the front display when the unit is turned on.

Cables required for connection (commercially available)

Speaker cables (x the number of speakers)



Audio pin cable (x1: for connecting a subwoofer)



5.1-channel system

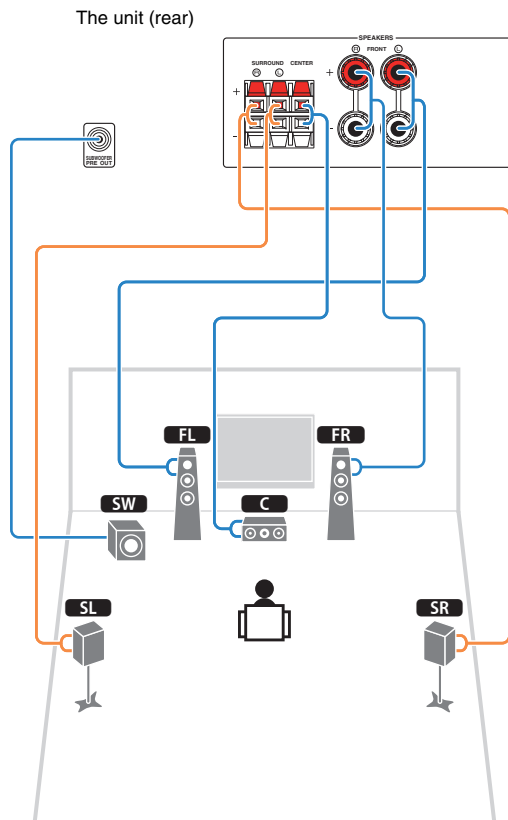

Connecting speaker cables

Speaker cables have two wires. One is for connecting the negative (-) terminal of the unit and the speaker, and the other is for the positive (+) terminal. If the wires are colored to prevent confusion, connect the black wire to the negative and the other wire to the positive terminal.

(Connecting front speakers)

- Remove approximately 10 mm (3/8") of insulation from the ends of the speaker cable and twist the bare wires of the cable firmly together.
- Loosen the speaker terminal.
- Insert the bare wires of the cable into the gap on the side (upper right or bottom left) of the terminal.
- Tighten the terminal.

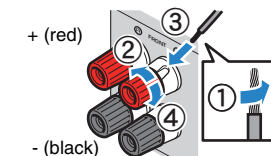

Using a banana plug

(U.S.A., Canada, Australia, Taiwan and General models only)

- Tighten the speaker terminal.
- Insert a banana plug into the end of the terminal.

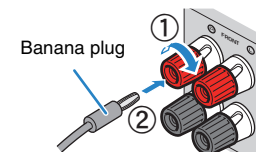

(Connecting center/surround speakers)

- ① Remove approximately 10 mm (3/8") of insulation from the ends of the speaker cable, and twist the bare wires of the cable firmly together.
- ② Press down the tab.
- ③ Insert the bare wires of the cable into the hole in the terminal.
- ④ Release the tab.

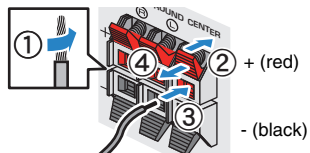
**■ Connecting the subwoofer (with built-in amplifier)**

Use an audio pin cable to connect the subwoofer.

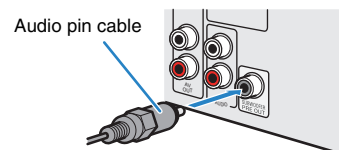

Input/output jacks and cables

Video/audio jacks

VIDEO jacks

Transmit digital video and digital sound through a single jack. Use an HDMI cable.



- Use a 19-pin HDMI cable with the HDMI logo. We recommend using a cable less than 5.0 m (16.4 ft) long to prevent signal quality degradation.



- The unit's HDMI jacks support the HDMI Control, Audio Return Channel (ARC), and 3D and 4K Ultra HD video transmission (through output) features.
- Use high speed HDMI cables to enjoy 3D or 4K Ultra HD videos.

VIDEO jacks

COMPONENT VIDEO jacks

Transmit video signals separated into three components: luminance (Y), chrominance blue (Pb), and chrominance red (Pr). Use a component video cable with three plugs.

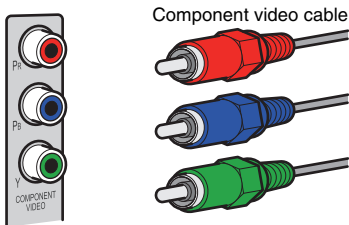

VIDEO jacks

Transmit analog video signals. Use a video pin cable.

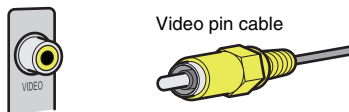

Audio jacks

OPTICAL jacks

Transmit digital audio signals. Use a digital optical cable. Remove the tip protector (if available) before using the cable.



COAXIAL jacks

Transmit digital audio signals. Use a digital coaxial cable.



AUDIO jacks

(Stereo L/R jacks)

Transmit analog stereo audio signals. Use a stereo pin cable (RCA cable).

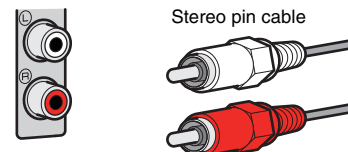

(Stereo mini jack)

Transmits analog stereo audio signals. Use a stereo mini-plug cable.



3 Connecting a TV

Connect a TV to the unit so that video input to the unit can be output to the TV. You can also enjoy playback of TV audio on the unit.

To maximize the performance of the unit, we recommend connecting a TV with an HDMI cable.

■ HDMI connection

Connect the TV to the unit with an HDMI cable and a digital optical cable.

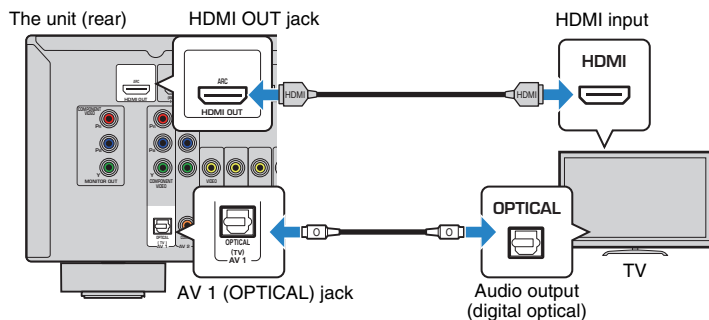

- You do not make a digital optical cable connection between the TV and the unit in the following cases:
 - If your TV supports Audio Return Channel (ARC)
 - If you will receive TV broadcasts only from the set-top box
- If you connect a TV that supports HDMI Control to the unit with an HDMI cable, you can control the unit's power and volume with the TV's remote control.

To use HDMI Control and ARC, you need to configure the HDMI settings on the unit. For details on the settings, see "Information on HDMI" (p.76).

About Audio Return Channel (ARC)

- ARC allows audio signals to travel both ways. If you connect a TV that supports ARC to the unit with a single HDMI cable, you can output video/audio to the TV or input TV audio to the unit.
- When using ARC, connect a TV with an HDMI cable that supports ARC.

■ Component / composite video connection

When connecting any video device with a component video cable, connect the TV to the MONITOR OUT (COMPONENT VIDEO) jacks.

When connecting any video device with a video pin cable, connect the TV to the MONITOR OUT (VIDEO) jack.



- If you connect your TV to the unit with a cable other than HDMI, video input to the unit via HDMI cannot be output to the TV.
- Operations with TV screen are available only when your TV is connected to the unit via HDMI.



- If you will receive TV broadcasts only from the set-top box, you do not need to make an audio cable connection between the TV and the unit.

□ COMPONENT VIDEO connection (with a component video cable)

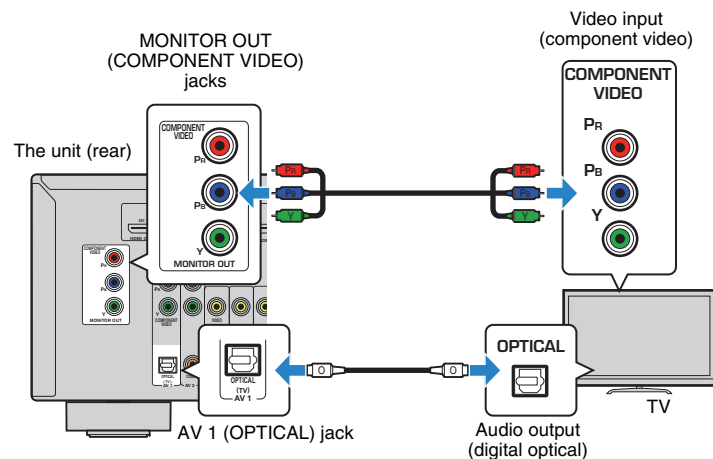

❑ VIDEO (composite video) connection (with a video pin cable)

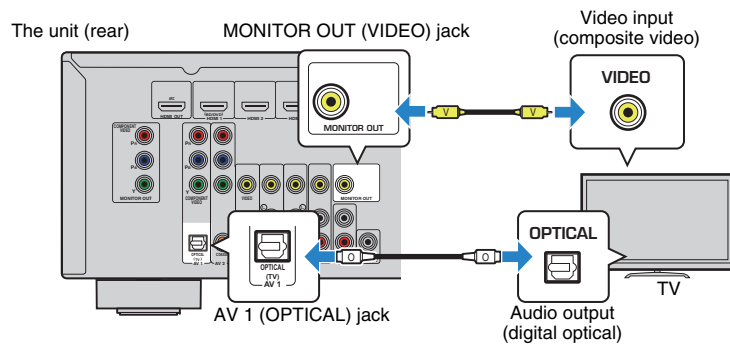

4 Connecting playback devices

The unit is equipped with a variety of input jacks including HDMI input jacks to allow you to connect different types of playback devices. For information on how to connect an iPod or a USB storage device, see the following pages.

- Connecting an iPod (p.41)
- Connecting a USB storage device (p.45)

Connecting video devices (such as BD/DVD players)

Connect video devices such as BD/DVD players, set-top boxes (STBs) and game consoles to the unit. Depending on the video/audio output jacks available on your video device, choose one of the following connections. We recommend using an HDMI connection if the video device has an HDMI output jack.



- If the combination of video/audio input jacks available on the unit does not match your video device, change its combination according to the output jacks of your device (p.21).

HDMI connection

Connect a video device to the unit with an HDMI cable.

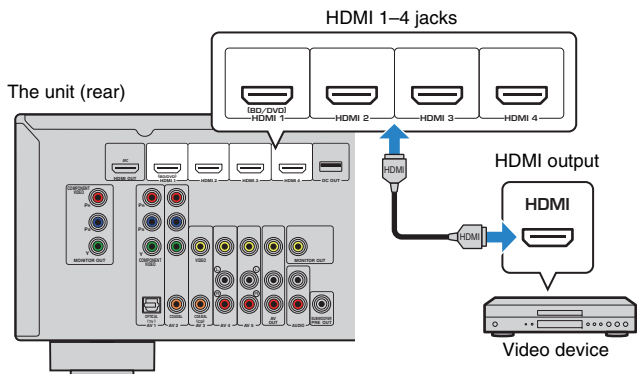

If you select the input source by pressing HDMI 1-4, the video/audio played back on the video device will be output from the unit.



- To watch videos input to the HDMI 1-4 jacks, you need to connect your TV to the HDMI OUT jack of the unit (p.18 to 20).

Component video connection

Connect a video device to the unit with a component video cable and an audio cable (digital optical or digital coaxial). Choose a set of input jacks (on the unit) depending on the audio output jacks available on your video device.

| Output jacks on video device | | Input jacks on the unit |
|------------------------------|-----------------|---|
| Video | Audio | |
| Component video | Digital optical | AV 1 (COMPONENT VIDEO + OPTICAL) |
| | Digital coaxial | AV 2 (COMPONENT VIDEO + COAXIAL) |
| | Analog Stereo | You need to change the combination of video/audio input jacks (p.21). |

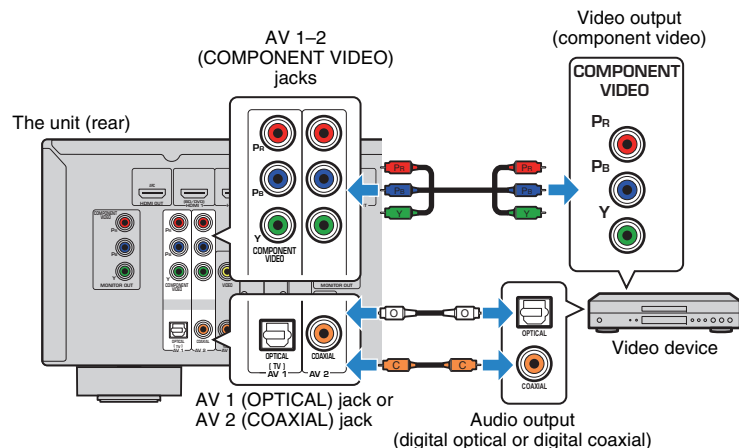

If you select the input source by pressing AV 1-2, the video/audio played back on the video device will be output from the unit.



- To watch videos input to the AV 1-2 (COMPONENT VIDEO) jacks, you need to connect your TV to the MONITOR OUT (COMPONENT VIDEO) jacks of the unit (p.18).

■ Composite video connection

Connect a video device to the unit with a video pin cable and an audio cable (digital coaxial or stereo pin cable). Choose a set of input jacks (on the unit) depending on the audio output jacks available on your video device.

| Output jacks on video device | | Input jacks on the unit |
|------------------------------|-----------------|---|
| Video | Audio | |
| Composite video | Digital coaxial | AV 3 (VIDEO + COAXIAL) |
| | Analog stereo | AV 4-5 (VIDEO + AUDIO) |
| | Digital optical | You need to change the combination of video/audio input jacks (p.21). |

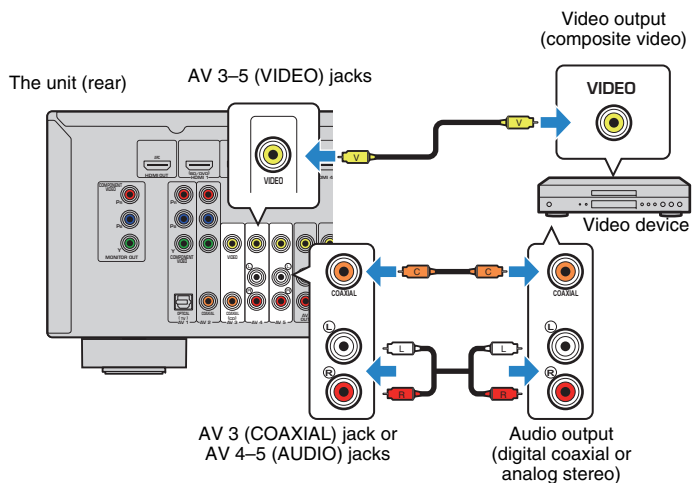

If you select the input source by pressing AV 3-5, the video/audio played back on the video device will be output from the unit.



- To watch videos input to the AV 3-5 (VIDEO) jacks, you need to connect your TV to the MONITOR OUT (VIDEO) jack of the unit (p.18).

■ Changing the combination of video/audio input jacks

If the combination of video/audio input jacks available on the unit does not match your video device, change its combination according to the output jacks of your device. You can connect a video device that has the following video/audio output jacks.

| Output jacks on video device | | Input jacks on the unit | |
|------------------------------|-----------------|-----------------------------|-------------------------|
| Video | Audio | Video | Audio |
| HDMI | Digital optical | HDMI 1-4 | AV 1 (OPTICAL) |
| | Digital coaxial | HDMI 1-4 | AV 2-3 (COAXIAL) |
| | Analog stereo | HDMI 1-4 | AV 4-5 (AUDIO) AUDIO |
| Component video | Analog stereo | AV 1-2 (COMPONENT VIDEO) | AV 4-5 (AUDIO) AUDIO |
| Composite video | Digital optical | AV 3-5 (VIDEO) | AV 1 (OPTICAL) |

□ Necessary setting

For example, if you have connected a video device to AV 2 (COMPONENT VIDEO) and AV 5 (AUDIO) jacks of the unit, change the combination setting as follows.

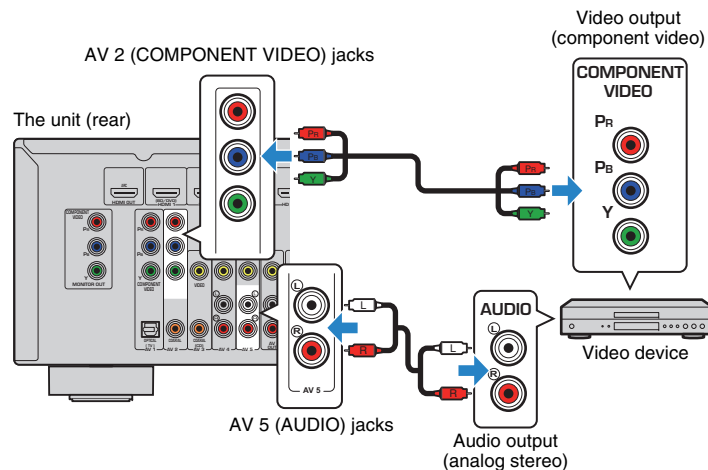

- 1 After connecting external devices (such as a TV and playback devices) and power cable of the unit, turn on the unit.
- 2 Press AV 2 to select “AV 2” (video input jack to be used) as the input source.
- 3 Press OPTION.
- 4 Use the cursor keys (Δ/▽) to select “Audio In” and press ENTER.



- 5 Use the cursor keys (◀/▶) to select “AV 5” (audio input jack to be used).



- 6 Press OPTION.

This completes the necessary settings.

If you select “AV 2” as the input source by pressing AV 2, the video/audio played back on the video device will be output from the unit.

Connecting audio devices (such as CD players)

Connect audio devices such as CD players and MD players to the unit. Depending on the audio output jacks available on your audio device, choose one of the following connections.

| Audio output jacks on audio device | Audio input jacks on the unit |
|------------------------------------|-------------------------------|
| Digital optical | AV 1 (OPTICAL) |
| Digital coaxial | AV 2-3 (COAXIAL) |
| Analog stereo | AV 4-5 (AUDIO) AUDIO |

The unit (rear)

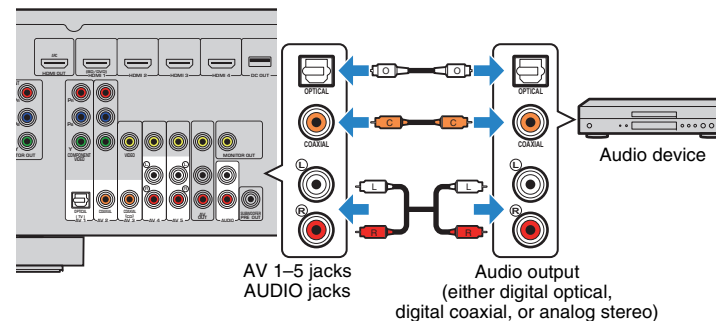

If you select the input source by pressing AV 1-5 or AUDIO, the audio played back on the audio device will be output from the unit.

Connecting to the jack on the front panel

Use the AUX jack on the front panel to temporarily connect devices such as portable audio players to the unit.

Before making a connection, stop playback on the device and turn down the volume on the unit.

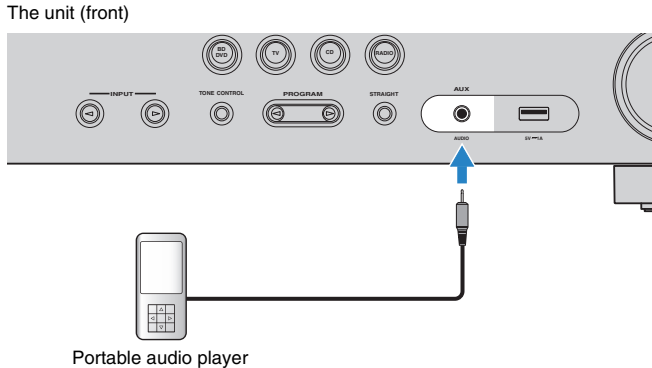

If you select "AUX" as the input source by pressing AUX, the audio played back on the device will be output from the unit.



- You need to prepare the audio cable that matches the output jacks on your device.



- For details on how to connect an iPod or a USB storage device, see "Connecting an iPod" (p.41) or "Connecting a USB storage device" (p.45).

5 Connecting the FM/AM antennas

Connect the supplied FM/AM antennas to the unit.

Fix the end of the FM antenna to a wall, and place the AM antenna on a flat surface.

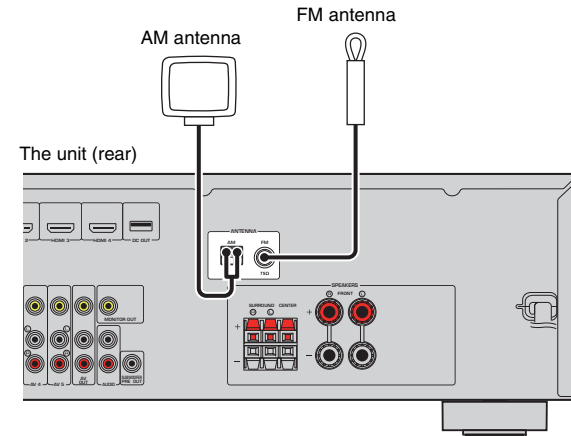

Assembling and connecting the AM antenna

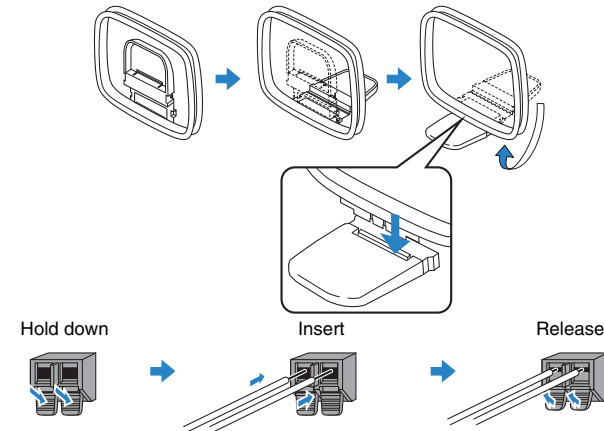

- Unwind only the length of cable needed from the AM antenna unit.
- The wires of the AM antenna have no polarity.

6 Connecting recording devices

You can connect video/audio recording devices to the AV OUT jacks. The jacks output analog video/audio signals selected as the input.



- To copy video/audio from a video device, connect the video device to the AV 4–5 jacks of the unit.
- To copy audio from an audio device, connect the audio device to the AV 4–5 jacks, AUDIO jacks, or AUX jack of the unit.
- Be sure to use the AV OUT jacks only for connecting recording devices.

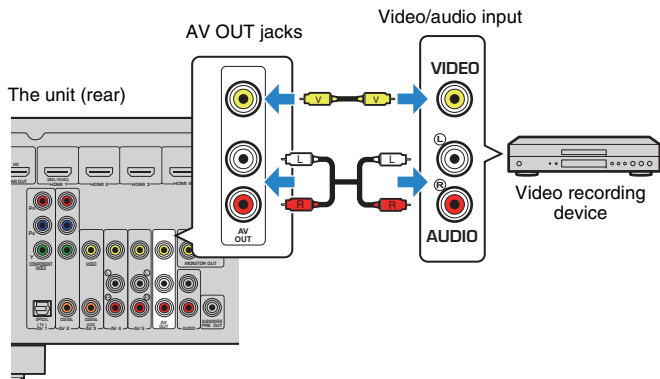

7 Connecting the power cable

Before connecting the power cable (Taiwan and General models only)

Set the switch position of VOLTAGE SELECTOR according to your local voltage. Voltages are AC 110–120/220–240 V, 50/60 Hz.



- Make sure you set VOLTAGE SELECTOR of the unit BEFORE plugging the power cable into an AC wall outlet. Improper setting of VOLTAGE SELECTOR may cause damage to the unit and create a potential fire hazard.

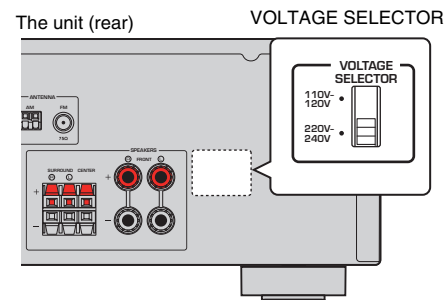

After all the connections are complete, plug in the power cable.

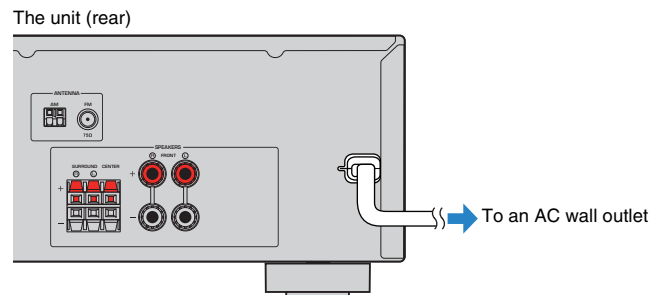

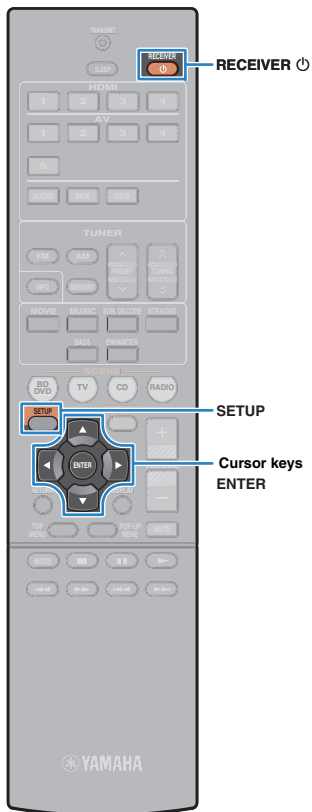

8 Selecting an on-screen menu language

Select the desired on-screen menu language from English, Japanese, French, German, Spanish, Russian, Italian and Chinese.

1 Press **RECEIVER** to turn on the unit.

2 Turn on the TV and switch the TV input to display video from the unit (HDMI OUT jack).



• Operations with TV screen are available only when your TV is connected to the unit via HDMI. If not, carry out operations while viewing the front display.

3 Press **SETUP**.

4 Use the cursor keys to select “Language” and press **ENTER**.

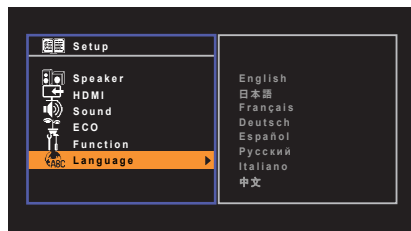

5 Use the cursor keys to select the desired language.



6 To exit from the menu, press **SETUP**.



• The information on the front display is provided in English only.



9 Optimizing the speaker settings automatically (YPAO)

The Yamaha Parametric room Acoustic Optimizer (YPAO) function detects speaker connections, measures the distances from them to your listening position(s), and then automatically optimizes the speaker settings, such as volume balance and acoustic parameters, to suit your room.



- Please note the following when using YPAO.
 - Use YPAO after connecting a TV and speakers to the unit.
 - During the measuring process, test tones are output at high volume. Ensure that the test tones do not frighten small children.
 - During the measuring process, you cannot adjust the volume.
 - During the measuring process, keep the room as quiet as possible.
 - Do not connect headphones.
 - Do not stand between the speakers and the YPAO microphone during the measurement process (about 3 minutes).

1 Press **RECEIVER** to turn on the unit.

2 Turn on the TV and switch the TV input to display video from the unit (HDMI OUT jack).



- Operations with TV screen are available only when your TV is connected to the unit via HDMI. If not, carry out operations while viewing the front display.

3 Turn on the subwoofer and set the volume to half. If the crossover frequency is adjustable, set it to maximum.

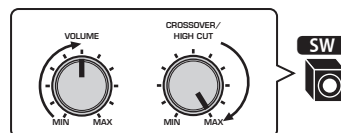

4 Place the YPAO microphone at your listening position and connect it to the YPAO MIC jack on the front panel.



- Place the YPAO microphone at your listening position (same height as your ears). We recommend the use of a tripod as a microphone stand. You can use the tripod screws to stabilize the microphone.

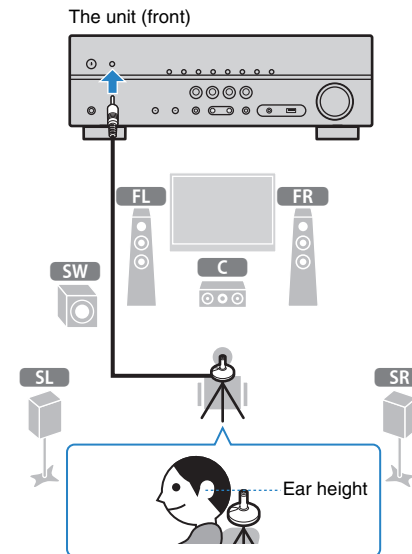

The following screen appears on the TV.

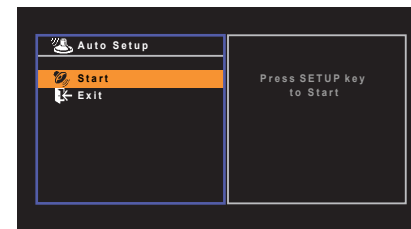

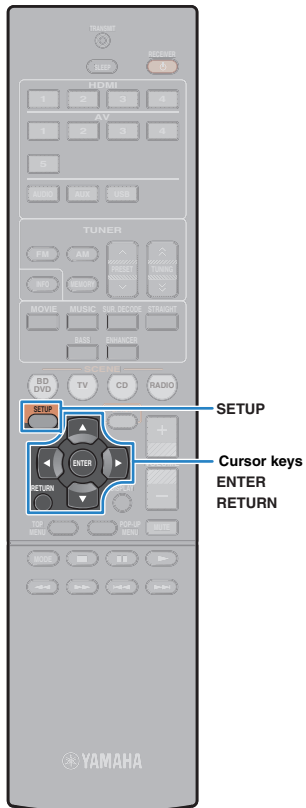

5 To start the measurement, use the cursor keys to select “Start” and press SETUP.

The measurement will start in 10 seconds. Press ENTER to start the measurement immediately.



- To stop the measurement temporarily, press RETURN and follow the procedure in “Error messages” (p.28).

The following screen appears on the TV when the measurement finishes.

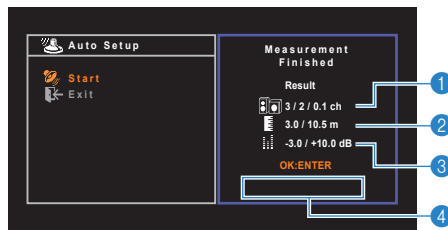

- 1 The number of speakers (front side/rear side/subwoofer)
- 2 Speaker distance (nearest/farthest)
- 3 Adjustment range of speaker output level
- 4 Warning message (if available)



- If any error message (such as E-1) or warning message (such as W-1) appears, see “Error messages” (p.28) or “Warning messages” (p.29).



- A speaker with a problem is indicated by blinking of the speaker indicators in the front display.
- If multiple warnings are given (when operating with the front display), use the cursor keys (Δ/▽) to check the other warning messages.

6 To save the measurement results, use the cursor keys (</>) to select “SAVE” and press ENTER.

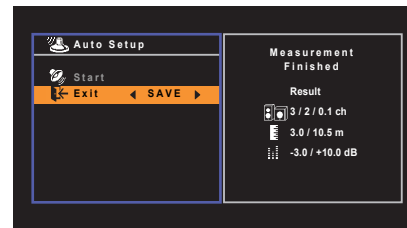

The adjusted speaker settings are applied.



- To finish the measurement without saving the result, select “CANCEL”.

7 Disconnect the YPAO microphone from the unit.

This completes optimization of the speaker settings.

Caution

- The YPAO microphone is sensitive to heat, so should not be placed anywhere where it could be exposed to direct sunlight or high temperatures (such as on top of AV equipment).

Error messages

If any error message is displayed during the measurement, resolve the problem and perform YPAO again.

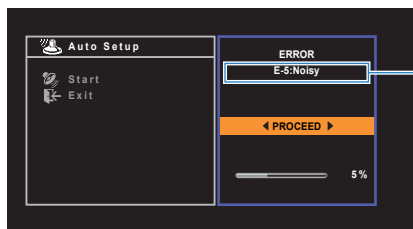

TV screen



Front display

Procedure to handle errors

1 Check the content of error message and press ENTER.

2 Use the cursor keys (◀/▶) to select the desired operation.

To exit the YPAO measurement:

- ① Select "EXIT" and press ENTER.
- ② Use the cursor keys (△/▽) to select "Exit" and press ENTER.
- ③ Disconnect the YPAO microphone from the unit.

To retry the YPAO measurement from beginning:

Select "RETRY" and press ENTER.

To proceed with the current YPAO measurement (for E-5 and E-9 only):

Select "PROCEED" and press ENTER.

| Error message | Cause | Remedy |
|---|--|--|
| E-1:No Front SP (E-1:NO FRNT SP) | Front speakers are not detected. | Exit YPAO, turn off the unit, and then check the speaker connections. |
| E-2:No Sur. SP (E-2:NO SUR SP) | One of the surround speakers cannot be detected. | |
| E-5:Noisy (E-5:NOISY) | The noise is too loud. | Keep the room quiet and retry YPAO. If you select "PROCEED", YPAO takes the measurement again and ignores any noise detected. |
| E-7:No MIC (E-7:NO MIC) | The YPAO microphone has been removed. | Connect the YPAO microphone to the YPAO MIC jack firmly and retry YPAO. |
| E-8:No Signal (E-8:NO SIGNAL) | The YPAO microphone cannot detect test tones. | Connect the YPAO microphone to the YPAO MIC jack firmly and retry YPAO. If this error occurs repeatedly, contact the nearest authorized Yamaha dealer or service center. |
| E-9:User Cancel (E-9:CANCEL) | The measurement has been canceled. | Retry or exit YPAO as necessary. |
| E-10:Internal Err. (E-10:INTERNAL) | An internal error has occurred. | Exit YPAO, and turn off and on the unit. If this error occurs repeatedly, contact the nearest authorized Yamaha dealer or service center. |



- Texts in parentheses denote indicators on the front display.

Warning messages

If a warning message is displayed after the measurement, you can still save the measurement results by following on-screen instructions. However, we recommend you perform YPAO again in order to use the unit with the optimal speaker settings.

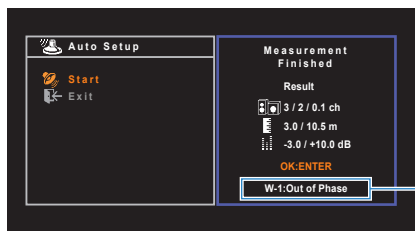

Warning message

TV screen

Problem speaker (blinks)



Front display

| Warning message | Cause | Remedy |
|---|---|--|
| W-1:Out of Phase (W-1:PHASE) | A speaker cable may be connected with the reverse polarity (+/-). | Check the cable connections (+/-) of the problem speaker. If the speaker is connected incorrectly: Turn off the unit, reconnect the speaker cable. If the speaker is connected correctly: Depending on the type of speakers or room environment, this message may appear even if the speakers are connected correctly. In this case, you can ignore the message. |
| W-2:Over Distance (W-2:DISTANCE) | A speaker is placed more than 24 m (80 ft) from the listening position. | Exit YPAO, turn off the unit, and place the problem speaker within 24 m (80 ft) of the listening position. |
| W-3:Level Error (W-3:LEVEL) | There are significant volume differences between the speakers. | Check the usage environment and cable connections (+/-) of each speaker, and the volume of the subwoofer. If there is any problem, exit YPAO, turn off the unit, and then reconnect speaker cable or correct the speaker positions. We recommend using the same speakers or speakers with specifications that are as similar as possible. |



- Texts in parentheses denote indicators on the front display.

Procedure to handle warnings

- 1 Check the content of warning message and press ENTER.**
- 2 Use the cursor keys (</>) to select the desired operation.**
 - To save the measurement results:**
Select "SAVE" and press ENTER.
 - To discard the measurement result:**
Select "CANCEL" and press ENTER.
- 3 Disconnect the YPAO microphone from the unit.**

PLAYBACK

Basic playback procedure

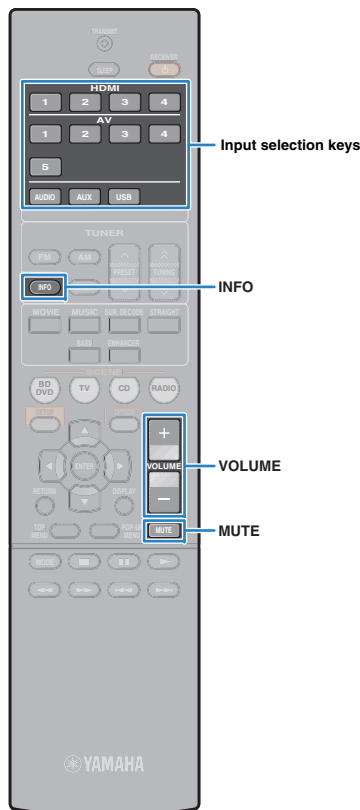

- 1 Turn on the external devices (such as a TV or BD/DVD player) connected to the unit.
- 2 Use the input selection keys to select an input source.
- 3 Start playback on the external device or select a radio station.

Refer to the instruction manual for the external device.

For details on the following operations, see the corresponding pages.

- Listening to FM/AM radio (p.37)
- Playing back iPod music (p.41)
- Playing back music stored on a USB storage device (p.45)

- 4 Press **VOLUME** to adjust the volume.



- To mute the audio output, press MUTE. Press MUTE again to unmute.
- To adjust the treble/bass settings, use the "Option" menu or TONE CONTROL on the front panel (p.49).

Switching information on the front display

- 1 Press **INFO**.

Each time you press the key, the displayed item changes.



Item name

About 3 seconds later, the corresponding information for the displayed item appears.



Information



- Available items vary depending on the selected input source. The displayed item can also be applied separately to each input source group.

| Input source group | Item |
|--------------------|--|
| HDMI 1-4 | |
| AV 1-5 | Input (input source name), DSP Program (sound mode name), Audio Decoder (decoder name*) |
| AUDIO | |
| AUX | Song (song title), Artist (artist name), Album (album name), DSP Program (sound mode name), Audio Decoder (decoder name*) |
| USB | * During simple playback of iPod: Input (input source name), DSP Program (sound mode name), Audio Decoder (decoder name) |
| | Frequency (frequency), DSP Program (sound mode name), Audio Decoder (decoder name*) |
| TUNER | * (U.K. and Europe models only) Radio Data System data is also available when the unit is tuned into a Radio Data System broadcasting station (p.40). |

* The name of the audio decoder currently activated is displayed. If no audio decoder is activated, "Decoder Off" appears.

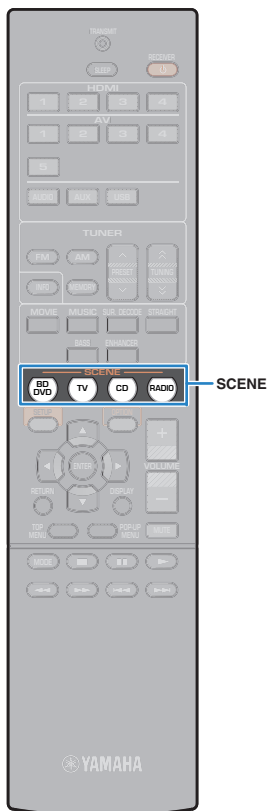

Selecting the input source and favorite settings with one touch (SCENE)

The SCENE function allows you to select the assigned input source, sound program, and Compressed Music Enhancer on/off with just one touch.

1 Press SCENE.

The input source and settings registered to the corresponding scene are selected. The unit turns on automatically when it is in standby mode.

By default, the following settings are registered for each scene.

| SCENE | Input | Sound program | Compressed Music Enhancer | SCENE link playback |
|--------|--------|--------------------|---------------------------|---------------------|
| BD/DVD | HDMI 1 | MOVIE (Sci-Fi) | Off | On |
| TV | AV 1 | STRAIGHT | On | On |
| CD | AV 3 | STRAIGHT | Off | Off |
| RADIO | TUNER | MUSIC (5ch Stereo) | On | Off |



- The SCENE link playback function allows you to automatically turn on the TV or start playback of an external device connected to the unit via HDMI, in conjunction with a scene selection. To enable SCENE link playback, set "SCENE" (p.58) in the "Setup" menu to "On".

Configuring scene assignments

1 Perform the following operations to prepare the settings you want to assign to a scene.

- Select an input source (p.30)
- Select a sound program (p.32)
- Enable/disable Compressed Music Enhancer (p.36)

2 Hold down the desired SCENE key until "SET Complete" appears on the front display.





MOVIE
MUSIC
SUR.DECODE
STRAIGHT
BASS
ENHANCER

Selecting the sound mode

The unit is equipped with a variety of sound programs and surround decoders that allow you to enjoy playback sources with your favorite sound mode (such as sound field effect or stereo playback).

Selecting a sound program suitable for movies

- Press MOVIE repeatedly.

This mode lets you enjoy sound field effects optimized for viewing video sources, such as movies, TV programs, and games (p.33).

Selecting a sound program suitable for music or stereo playback

- Press MUSIC repeatedly.

This mode lets you enjoy sound field effects optimized for listening music sources or stereo playback (p.34).

Selecting a surround decoder

- Press SUR.DECODE repeatedly.

This mode lets you enjoy unprocessed multichannel playback from 2-channel sources (p.35).

Switching to the straight decode mode

- Press STRAIGHT.

This mode lets you enjoy unprocessed sounds in original channels (p.35).

Enabling Extra bass

- Press BASS.

This mode lets you enjoy enhanced bass sounds (p.36).

Enabling Compressed Music Enhancer

- Press ENHANCER.

This mode lets you enjoy compressed music with additional depth and breadth (p.36).



- You can also switch the sound programs and surround decoder by pressing PROGRAM on the front panel.
- The sound mode can be applied separately to each input source.
- When you play back audio signals with a sampling rate of higher than 96 kHz or playing back DTS Express, the straight decode mode (p.35) is automatically selected.
- You can check which speakers are currently outputting sound by looking at the speaker indicators on the unit's front panel (p.8).

Enjoying sound field effects (CINEMA DSP)

CINEMA DSP

The unit is equipped with a variety of sound programs that utilize Yamaha's original DSP technology (CINEMA DSP). It allows you to easily create sound fields like actual movie theaters or concert halls in your room.

Sound program category

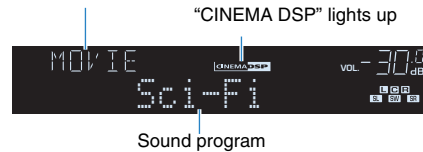

- You can adjust the sound field effect level in “DSP Level” (p.49) in the “Option” menu.

■ Sound programs suitable for movies (MOVIE)

The following sound programs are optimized for viewing video sources, such as movies, TV programs, and games.

| | |
|------------------|--|
| Standard | This program creates a sound field that emphasizes the surround feeling without disturbing the original acoustic positioning of multichannel audio, such as Dolby Digital and DTS. Its design is based on the concept of the ideal movie theater, in which the audience is surrounded by beautiful reverberations from the left, right, and rear. |
| Spectacle | This program delivers the scale and grandeur of spectacular movie productions. It delivers an expansive sound space to match the cinemascope wide-screen, and boasts a broad dynamic range, providing everything from small delicate sounds to powerful loud booms. |
| Sci-Fi | This program clearly reproduces the finely elaborated sound design of the latest Sci-Fi and SFX movies. You can enjoy a variety of cinematographically created virtual spaces reproduced with clear separation between dialogue, sound effects, and background music. |
| Adventure | This program is ideal for reproducing the sound design of action and adventure movies precisely. The sound field restrains reverberations, but puts emphasis on reproducing a sensation of expansiveness on both sides, powerful space expanded widely to the left and right. The restrained depth creates a clear and powerful space, while also maintaining the articulation of the sounds and the separation of the channels. |

| | |
|-------------------------|---|
| Drama | This program features stable reverberations that match a wide range of movie genres, from serious dramas to musicals and comedies. The reverberations are modest, but suitably stereophonic. The sound effects and background music are reproduced with a gentle echo that does not impinge on the articulation of the dialogue. You'll never get tired listening for long periods. |
| Mono Movie | This program reproduces monaural video sources, such as classic movies, in an atmosphere of a good old movie theater. The program creates a pleasant space with depth, by adding breadth and the appropriate reverberation to the original audio. |
| Sports | This program allows listeners to enjoy the rich vividness of sport broadcasts and light entertainment programs. In sports broadcasts, the commentators' voices are positioned clearly at the center, while the atmosphere inside the stadium is realistically conveyed by the peripheral delivery of the sounds of the fans in a suitable space. |
| Action Game | This program is suitable for action games, such as car racing and fighting games. The reality of, and emphasis on, various effects makes the player feel like they are right in the middle of the action, allowing for greater concentration. Use this program in combination with Compressed Music Enhancer for a more dynamic and strong sound field. |
| Roleplaying Game | This program is suitable for role-playing and adventure games. This program adds depth to the sound field for natural and realistic reproduction of background music, special effects, and dialogue from a wide variety of scenes. Use this program in combination with Compressed Music Enhancer for a clearer and more spatial sound field. |

■ Sound programs suitable for music/stereo playback (MUSIC)

The following sound programs are optimized for listening to music sources.

You can also select stereo playback.

| | |
|-------------------------|---|
| Hall in Munich | This program simulates a Munich concert hall with approximately 2,500 seats that uses stylish wood for the interior finishing. Fine, beautiful reverberations spread richly, creating a calming atmosphere. The listener's virtual seat is at the center left of the arena. |
| Hall in Vienna | This program simulates a 1700-seat, middle-sized concert hall with a shoebox shape that is traditional in Vienna. Pillars and ornate carvings create extremely complex reverberations from all around the audience, producing a very full, rich sound. |
| Chamber | This program creates a relatively wide space with a high ceiling, like an audience hall in a palace. It offers pleasant reverberations that are suitable for courtly music and chamber music. |
| Cellar Club | This program simulates an intimate concert venue with a low ceiling and homey atmosphere. A realistic, live sound field delivers powerful sounds that make you feel as if you are sitting in the front row in front of a small stage. |
| The Roxy Theatre | This program creates the sound field of a 460-seat rock music concert venue in Los Angeles. The listener's virtual seat is at the center left of the hall. |
| The Bottom Line | This program creates the sound field at stage front in The Bottom Line, a famous New York jazz club once. The floor can seat 300 people to the left and right in a sound field offering real and vibrant sound. |
| Music Video | This program allows you to enjoy videos of pop, rock, and jazz concerts, as if you were there yourself. Immerse yourself in the hot concert atmosphere thanks to the vividness of the singers and solos on stage, a presence sound field that emphasizes the beat of rhythm instruments, and a surround sound field that reproduces the space of a big live hall. |
| 2ch Stereo | Use this program to mix down multichannel sources to 2 channels. When multichannel signals are input, they are down mixed to 2 channels and output from the front speakers (this program does not utilize CINEMA DSP). |
| 5ch Stereo | Use this program to output sound from all speakers. When you play back multichannel sources, the unit mixes down the source to 2 channels, and then outputs the sound from all speakers. This program creates a larger sound field and is ideal for background music at parties. |

■ Enjoying sound field effects without surround speakers (Virtual CINEMA DSP)

If you select one of the sound programs (except 2ch Stereo and 5ch Stereo) when no surround speakers are connected, the unit automatically creates the surround sound field using the front-side speakers.

■ Enjoying surround sound with 5 speakers placed in front (Virtual CINEMA FRONT)

You can enjoy the surround sound even when the surround speakers are placed in front.

■ Enjoying surround sound with headphones (SILENT CINEMA)

SILENT™
CINEMA

You can enjoy surround or sound field effects, like a multichannel speaker system, with stereo headphones by connecting the headphones to the PHONES jack and selecting a sound program or a surround decoder.



SUR. DECODE
STRAIGHT

Enjoying unprocessed playback

You can play back input sources without any sound field effect processing.

■ Enjoying unprocessed sounds in original channels (straight decode)

When the straight decode mode is enabled, each speaker produces its own channel audio signal (without sound field processing). When you play back 2-channel sources, such as a CD player, stereo sound is heard from the front speakers. When you play back multichannel sources, the unit produces unprocessed multichannel sounds.

1 Press STRAIGHT.

Each time you press the key, the straight decode mode is enabled or disabled.



■ Enjoying unprocessed multichannel sounds (surround decoder)

The surround decoder enables unprocessed multichannel playback from 2-channel sources. When a multichannel source is input, it works the same way as the straight decode mode.

For details on each decoder see "Glossary" (p.73).

1 Press SUR.DECODE to select a surround decoder.

Each time you press the key, the surround decoder changes.



| | |
|-------------------------|--|
| Dolby Pro Logic | Uses the Dolby Pro Logic decoder suitable for all sources. |
| Dolby PLII Movie | Uses the Dolby Pro Logic II decoder suitable for movies. |
| Dolby PLII Music | Uses the Dolby Pro Logic II decoder suitable for music. |
| Dolby PLII Game | Uses the Dolby Pro Logic II decoder suitable for games. |
| Neo: 6 Cinema | Uses the DTS Neo: 6 decoder suitable for movies. |
| Neo: 6 Music | Uses the DTS Neo: 6 decoder suitable for music. |



- You can adjust the surround decoder parameters in "DSP Parameter" (p.59) in the "Setup" menu.

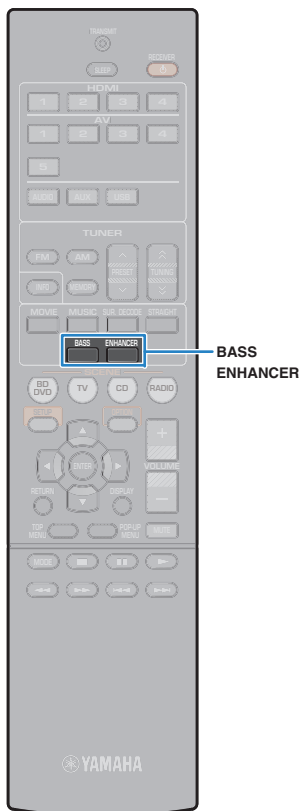

Enhancing the bass (Extra Bass)

Extra Bass allows you to enjoy enhanced bass sounds, regardless of the size of the front speakers and the presence or absence of the subwoofer.

1 Press BASS.

Each time you press the key, Extra Bass is enabled or disabled.



- You can also use “Extra Bass” (p.55) in the “Setup” menu to enable/disable Extra Bass.

Enjoying compressed music with enhanced sound (Compressed Music Enhancer)

compressed music ENHANCER

Compressed Music Enhancer adds depth and breadth to the sound, allowing you to enjoy a dynamic sound close to the original sound before it was compressed. This function can be used along with any other sound modes.

1 Press ENHANCER.

Each time you press the key, Compressed Music Enhancer is enabled or disabled.

“ENHANCER” lights up



- Compressed Music Enhancer does not work on the following audio sources.
 - Signals whose sampling rate is over 48 kHz
 - High-definition streaming audio



- You can also use “Enhancer” (p.49) in the “Option” menu to enable/disable Compressed Music Enhancer.

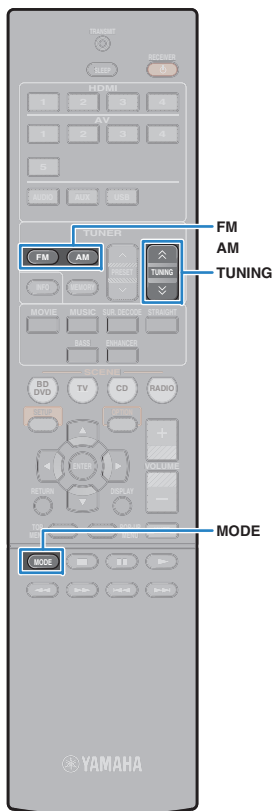

Listening to FM/AM radio

You can tune into a radio station by specifying its frequency or selecting from registered radio stations.



- The radio frequencies differ depending on the country or region where the unit is being used. The explanation of this section uses a display with frequencies used in U.K. and Europe models.
- If you cannot obtain good reception on the radio, adjust the direction of the FM/AM antennas.

Setting the frequency steps

(Asia, Taiwan and General models only)

At the factory, the frequency step setting is set to 50 kHz for FM and 9 kHz for AM. Depending on your listening environment, set the frequency steps to 100 kHz for FM and 10 kHz for AM.

- 1 Set the unit to standby mode.
- 2 When holding down **STRAIGHT** on the front panel, press **⏻** (power).

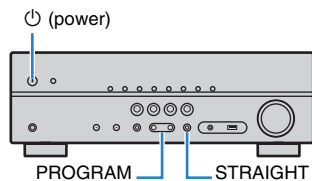

- 3 Press **PROGRAM** repeatedly to select “TU”.



- 4 Press **STRAIGHT** to select “FM100/AM10”.
- 5 Press **⏻** (power) to set the unit to standby mode and turn it on again.

Selecting a frequency for reception

- 1 Press **FM** or **AM** to select a band.

“TUNER” is selected as the input source and then the frequency currently selected is displayed.



- 2 Press **TUNING** repeatedly to set a frequency.

Hold down the key for about a second to search stations automatically.



“TUNED” lights up when a signal is received from a radio station.

“STEREO” also lights up when a stereo signal is received.



- You can switch between “Stereo” (stereo) and “Mono” (monaural) for FM radio reception by pressing **MODE**. When the signal reception for an FM radio station is unstable, switching to monaural may improve it.
- You can watch videos input from external devices while listening to radio by selecting the video input jack in “Video Out” (p.50) in the “Option” menu.

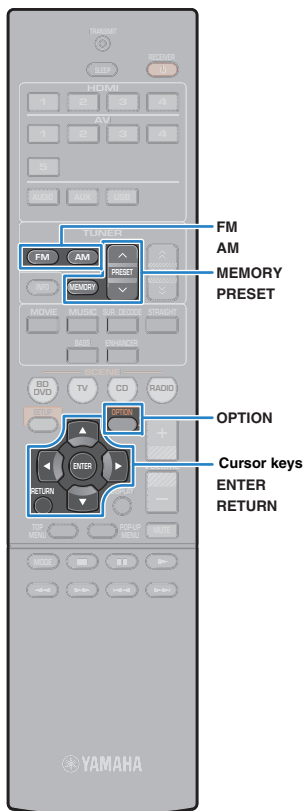

Registering favorite radio stations (presets)

You can register up to 40 radio stations as presets. Once you have registered stations, you can easily tune into them by selecting their preset numbers.

■ Registering radio stations automatically (Auto Preset)

Automatically register FM radio stations with strong signals (up to 40 stations).



- To register AM radio stations, follow “Registering a radio station manually”.
- (U.K. and Europe models only)
Only Radio Data System broadcasting stations are stored automatically by the Auto Preset function.

- 1 Press **FM** or **AM** to select “TUNER” as the input source.
- 2 Press **OPTION**.
- 3 Use the cursor keys to select “Auto Preset”.



- 4 To start the Auto Preset process, press **ENTER**.

The registration will start in 5 seconds. Press **ENTER** again to start the registration immediately.

“SEARCH” appears during Auto Preset



Preset number from which to start the registration



- To specify the preset number from which to start the registration, press **PRESET** or cursor keys (Δ/∇) to select a preset number within 5 seconds after step 4 (while “READY” is displayed) and then press **ENTER** (or just wait for 5 seconds).
- To cancel the Auto Preset process, press **RETURN**.

When the Auto Preset process finishes, “FINISH” appears and the “Option” menu closes automatically.



■ Registering a radio station manually

Select a radio station manually and register it to a preset number.

- 1 Follow “Selecting a frequency for reception” (p.37) to tune into the desired radio station.
- 2 Hold down **MEMORY** for more than 2 seconds.

The first time that you do register a station, the selected radio station will be registered to the preset number “01”. Thereafter, each radio station you select will be registered to the next empty (unused) preset number after the most recently registered number.



Preset number



- To select a preset number for registering, press **MEMORY** once after tuning into the desired radio station, press **PRESET** to select a preset number, and then press **MEMORY** again.



“Empty” (not in use) or the frequency currently registered

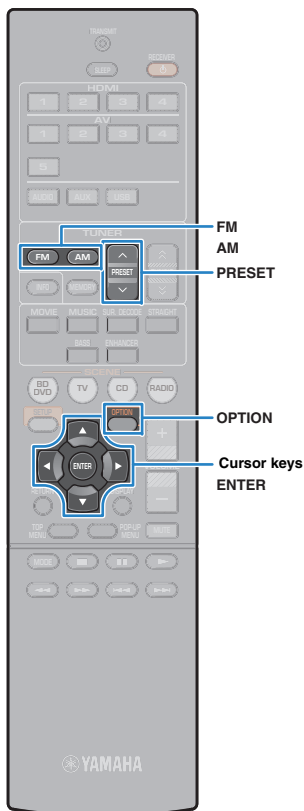

■ Selecting a preset station

Tune into a registered radio station by selecting its preset number.

- 1 Press FM or AM to select “TUNER” as the input source.
- 2 Press PRESET repeatedly to select the desired radio station.



- “No Presets” appears when no radio stations are registered.

■ Clearing preset stations

Clear radio stations registered to the preset numbers.

- 1 Press FM or AM to select “TUNER” as the input source.
- 2 Press OPTION.
- 3 Use the cursor keys to select “Clear Preset” and press ENTER.



- 4 Use the cursor keys (Δ/∇) to select a preset station to be cleared and press ENTER.



Preset station to be cleared

If the preset station is cleared, “Cleared” appears and then the next in-use preset number is displayed.



- 5 Repeat step 4 until all desired preset stations are cleared.
- 6 To exit from the menu, press OPTION.

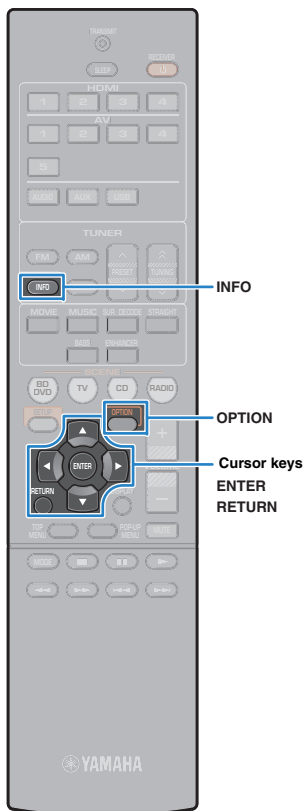

Radio Data System tuning

(U.K. and Europe models only)

Radio Data System is a data transmission system used by FM stations in many countries. The unit can receive various types of Radio Data System data, such as “Program Service”, “Program Type,” “Radio Text” and “Clock Time”, when it is tuned into a Radio Data System broadcasting station.

■ Displaying the Radio Data System information

1 Tune into the desired Radio Data System broadcasting station.



- We recommend using “Auto Preset” to tune into the Radio Data System broadcasting stations (p.38).

2 Press INFO.

Each time you press the key, the displayed item changes.



Item name

About 3 seconds later, the corresponding information for the displayed item appears.



Information

| | |
|------------------------|------------------------------------|
| Program Service | Program service name |
| Program Type | Current program type |
| Radio Text | Information on the current program |
| Clock Time | Current time |
| DSP Program | Sound mode name |
| Audio Decoder | Decoder name |
| Frequency | Frequency |



- “Program Service”, “Program Type”, “Radio Text”, and “Clock Time” are not displayed if the radio station does not provide the Radio Data System service.

■ Receiving traffic information automatically

When “TUNER” is selected as the input source, the unit automatically receives traffic information. To enable this function, follow the procedure below to set the traffic information station.

1 When “TUNER” is selected as the input source, press OPTION.

2 Use the cursor keys to select “Traffic Program” (TrafficProgram) and press ENTER.

The traffic information station search will start in 5 seconds. Press ENTER again to start the search immediately.



- To search upward/downward from the current frequency, press the cursor keys (Δ/∇) while “READY” is displayed.
- To cancel the search, press RETURN.
- Texts in parentheses denote indicators on the front display.

The following screen appears for about 3 seconds when the search finishes.



Traffic information station (frequency)



- “TP Not Found” appears for about 3 seconds when no traffic information stations are found.



Playing back iPod music

You can play back iPod music on the unit using a USB cable supplied with the iPod.



- You cannot play back iPod video on the unit.



- For details on playable iPod devices, see “Supported devices and file formats” (p.75).

Connecting an iPod

Connect your iPod to the unit with the USB cable supplied with the iPod.

- 1 Connect the USB cable to the iPod.
- 2 Connect the USB cable to the USB jack.

The unit (front)

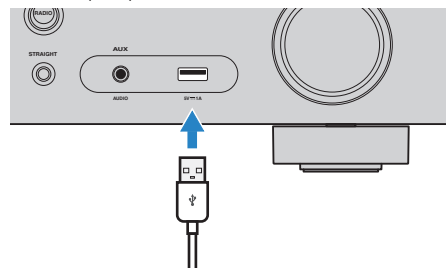

- The iPod charges while it is connected to the unit. If you set the unit to standby mode while the iPod is connected, the iPod continues to charge (up to 4 hours).



- Disconnect the iPod from the USB jack when it is not in use.

Playback of iPod content

Follow the procedure below to operate the iPod contents and start playback.

You can control the iPod with the menu displayed on the TV screen.



- Operations with TV screen are available only when your TV is connected to the unit via HDMI. If not, carry out operations while viewing the front display, or directly operate the iPod itself in the simple play mode (p.43).
- “_” (underscore) will be displayed for characters not supported by the unit.

1 Press USB to select “USB” as the input source.

The browse screen is displayed on the TV.

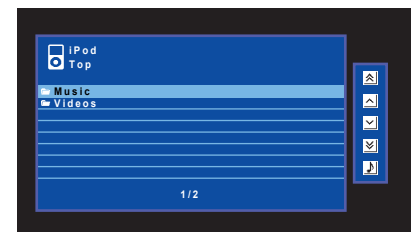

- If playback is ongoing on your iPod, the playback screen is displayed.



Cursor keys
 ENTER
 RETURN
 DISPLAY

2 Use the cursor keys to select an item and press ENTER.

If a song is selected, playback starts and the playback screen is displayed.

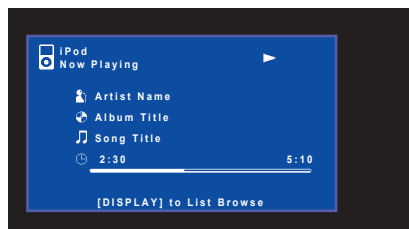

- To return to the previous screen, press RETURN.
- To switch between the browse and playback screens during playback, press DISPLAY.
- To operate the iPod manually to select content or control playback, switch to the simple play mode (p.43).

■ Browse screen



1 List name

2 Contents list

Displays the list of iPod content. Use the cursor keys to select an item and press ENTER to confirm the selection.

3 Item number/total

4 Status indicators

Display the current repeat/shuffle settings (p.44) and playback status (such as play/pause).

5 Operation menu

Press the cursor key (▷) and then use the cursor keys (△/▽) to select an item. Press ENTER to confirm the selection.

| Icon | Function |
|------|---|
| | Moves 10 pages backward. |
| | Moves to the previous page of the list. |
| | Moves to the next page of the list. |
| | Moves 10 pages forward. |
| | Moves to the playback screen. |

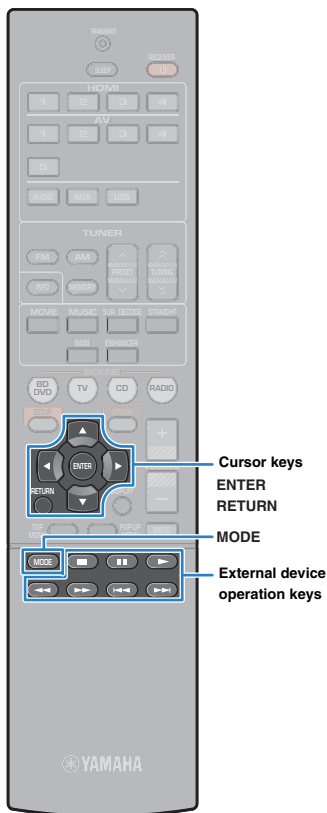

■ Playback screen



1 Status indicators

Display the current repeat/shuffle settings (p.44) and playback status (such as play/pause).

2 Playback information

Displays the artist name, album name, song title, and elapsed time/song length.

Use the following remote control keys to control playback.

| External device operation keys | Function |
|--------------------------------|--|
| | Resumes playback from pause. |
| | Stops playback. |
| | Stops playback temporarily. |
| | Skips forward/backward. |
| | Searches forward/backward (by holding down). |

■ Operating the iPod itself or remote control (simple play)

1 Press MODE to switch to the simple play mode.

The TV menu screen turns off and iPod operations are enabled.

To display the TV menu screen, press MODE again.

2 Operate your iPod itself or the remote control to start playback.

| Operational remote control keys | Function |
|---------------------------------|--|
| Cursor keys | Select an item. |
| ENTER | Confirms the selection. |
| RETURN | Returns to the previous screen. |
| | Starts playback or stops playback temporarily. |
| | Stops playback. |
| External device operation keys | |
| | Skips forward/backward. |
| | Searches forward/backward (by holding down). |

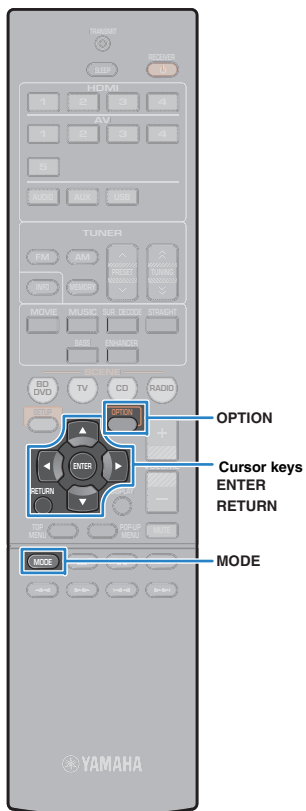

Repeat/shuffle settings

You can configure the repeat/shuffle settings of your iPod.



- During simple play, configure the repeat/shuffle settings directly on your iPod or press MODE to display the TV menu screen and then follow the procedure below.





1 When “USB” is selected as the input source, press **OPTION**.

2 Use the cursor keys to select “Repeat” (Repeat) or “Shuffle” (Shuffle) and press **ENTER**.



- To return to the previous screen during menu operations, press RETURN.
- Texts in parentheses denote indicators on the front display.

3 Use the cursor keys (</>) to select a setting.

| Item | Setting | Function |
|--------------------------|-----------------|---|
| | Off (Off) | Turns off the repeat function. |
| Repeat (Repeat) | One (One) | Plays back the current song repeatedly. “  ” appears in the TV screen. |
| | All (All) | Plays back all songs repeatedly. “  ” appears in the TV screen. |
| | Off (Off) | Turns off the shuffle function. |
| Shuffle (Shuffle) | Songs (Songs) | Plays back songs in random order. “  ” appears in the TV screen. |
| | Albums (Albums) | Plays back albums in random order. “  ” appears in the TV screen. |

4 To exit from the menu, press **OPTION**.



Playing back music stored on a USB storage device

You can play back music files stored on a USB storage device on the unit.



- For details on playable USB devices, see “Supported devices and file formats” (p.75).

Connecting a USB storage device

1 Connect the USB storage device to the USB jack.

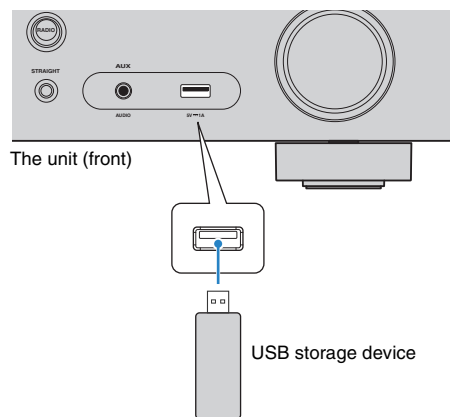

- If the USB storage device contains many files, it may take time to load the them. In this case, “Loading...” appears in the front display.



- Stop playback of the USB storage device before disconnect it from the USB jack.
- Connect a USB storage device directly to the USB jack of the unit. Do not use extension cables.

Playback of USB storage device contents

Follow the procedure below to operate the USB storage device contents and start playback.

You can control the USB memory device with the menu displayed on the TV screen.



- Operations with TV screen are available only when your TV is connected to the unit via HDMI. If not, carry out operations while viewing the front display.
- “_” (underscore) will be displayed for characters not supported by the unit.

1 Press USB to select “USB” as the input source.

The browse screen is displayed on the TV.

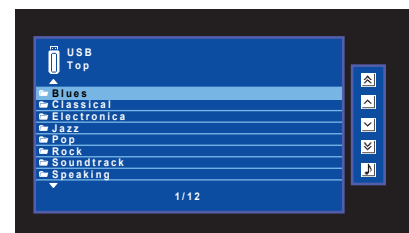

- If playback is ongoing on your USB storage device, the playback screen is displayed.



Cursor keys
 ENTER
 RETURN
 DISPLAY

2 Use the cursor keys to select an item and press ENTER.

If a song is selected, playback starts and the playback screen is displayed.

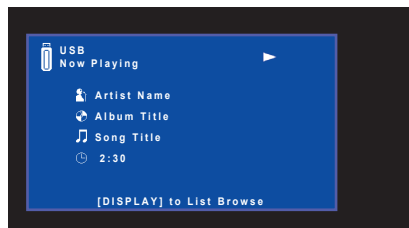

- To return to the previous screen, press RETURN.
- To switch between the browse and playback screens during playback, press DISPLAY.
- Files not supported by the unit cannot be selected.

■ Browse screen



1 List name

2 Contents list

Displays the list of USB storage device contents. Use the cursor keys to select an item and press ENTER to confirm the selection.

3 Item number/total

4 Status indicators

Display the current repeat/random settings (p.47) and playback status (such as play/pause).

5 Operation menu

Press the cursor key (▷) and then use the cursor keys (△/▽) to select an item. Press ENTER to confirm the selection.

| Icon | Function |
|------|---|
| | Moves 10 pages backward. |
| | Moves to the previous page of the list. |
| | Moves to the next page of the list. |
| | Moves 10 pages forward. |
| | Moves to the playback screen. |

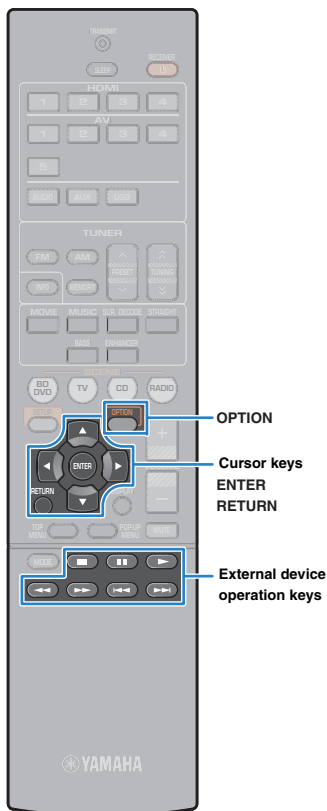

■ Playback screen



1 Status indicators

Display the current repeat/random settings (p.47) and playback status (such as play/pause).

2 Playback information

Displays the artist name, album name, song title, and elapsed time.

Use the following remote control keys to control playback.

| External device operation keys | Function |
|--------------------------------|---|
| | Resumes playback from pause or starts playback of the previously selected song. |
| | Stops playback. |
| | Stops playback temporarily. |
| | Skips forward/backward. |
| | Searches forward/backward (by holding down). |

■ Repeat/random settings

You can configure the repeat/random settings for playback of USB storage device contents.

1 When “USB” is selected as the input source, press **OPTION**.

2 Use the cursor keys to select “Repeat” (Repeat) and press **ENTER**.



- To return to the previous screen during menu operations, press **RETURN**.
- Texts in parentheses denote indicators on the front display.

3 Use the cursor keys (<|/>) to select a setting.

| Setting | Function |
|-----------------|---|
| Off (Off) | Turns off the repeat function. |
| One (One) | Plays back the current song repeatedly. “” appears on the TV screen. |
| All (All) | Plays back all songs in the current album (folder) repeatedly. “” appears on the TV screen. |
| Random (Random) | Plays back songs in random order. “” appears on the TV screen. |

4 To exit from the menu, press **OPTION**.

Configuring playback settings for different playback sources (Option menu)

You can configure separate playback settings for different playback sources. This menu is available on the front panel (or on the TV screen), allowing you to easily configure settings during playback.

1 Press **OPTION**.



Front display

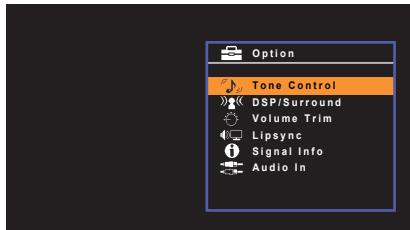

TV screen

2 Use the cursor keys to select an item and press **ENTER**.



- To return to the previous screen during menu operations, press **RETURN**.

3 Use the cursor keys (**</>**) to select a setting.

4 To exit from the menu, press **OPTION**.

Option menu items



- Available items vary depending on the selected input source.
- Text in parentheses denotes indicators on the front display.
- Default settings are underlined.

| Item | Function | Page |
|---|--|------|
| Tone Control (Tone Control) | Adjusts the high-frequency range and low-frequency range of sounds. | 49 |
| | DSP Level (DSP Level) | 49 |
| DSP/Surround (DSP/Surround) | Adaptive DRC (A.DRC) | 49 |
| | Enhancer (Enhancer) | 49 |
| Volume Trim (Volume Trim) | Input Trim (In.Trim) | 49 |
| | Subwoofer Trim (SW.Trim) | 49 |
| Lipsync (Lipsync) | Enables/disables the "Lipsync" setting in the "Setup" menu. | 50 |
| Signal Info (Signal Info) | Displays information about the video/audio signal. | 50 |
| Audio In (Audio In) | Combines the video jack of the selected input source with an audio jack of others. | 50 |
| Video Out (Video Out) | Selects a video to be output with radio sounds. | 50 |
| Auto Preset (Auto Preset) | Automatically registers FM radio stations with strong signals as presets. | 38 |
| Clear Preset (Clear Preset) | Clear radio stations registered to preset numbers. | 39 |
| Traffic Program (TrafficProgram) | (U.K. and Europe models only) Automatically searches for a traffic information station. | 40 |
| Repeat (Repeat) | Configures the repeat setting for the iPod (p.44) or USB storage device (p.47). | — |
| Shuffle (Shuffle) | Configures the shuffle setting for the iPod. | 44 |

■ Tone Control (Tone Control)

Adjusts the high-frequency range (Treble) and low-frequency range (Bass) of sounds.

Choices

Treble (Treble), Bass (Bass)

Setting range

-6.0 dB to Bypass (Bypass) to +6.0 dB (0.5 dB increments)



- You can also adjust the tone with the front panel controls. Press TONE CONTROL to select "Treble" or "Bass", then press PROGRAM to make an adjustment.



- If you set an extreme value, sounds may not match those from other channels.

■ DSP/Surround (DSP/Surround)

Configures the sound field program and surround settings.

□ DSP Level (DSP Level)

Adjusts the sound field effect level.

Setting range

-6 dB to 0 dB to +3 dB (1 dB increments)

□ Adaptive DRC (A.DRC)

Sets whether the dynamic range (from maximum to minimum) is automatically adjusted when the volume level is adjusted. When it is set to "On", it is useful for listening to playback at a low volume at night.

Settings

| | |
|-----------|--|
| On (On) | Automatically adjusts the dynamic range. |
| Off (Off) | The dynamic range is not automatically adjusted. |

If "On" is selected, the dynamic range becomes narrow at a low volume and wide at a high volume.

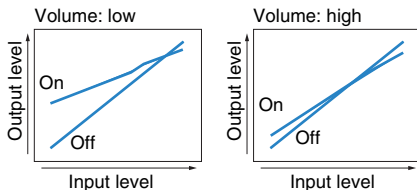

□ Enhancer (Enhancer)

Enables/disables Compressed Music Enhancer (p.36).



- This setting is applied separately to each input source.
- You can also use ENHANCER on the remote control to enable/disable Compressed Music Enhancer (p.36).

Settings

| | |
|-----------|-------------------------------------|
| Off (Off) | Disables Compressed Music Enhancer. |
| On (On) | Enables Compressed Music Enhancer. |

Default

USB, TUNER: On (On)

Others: Off (Off)

■ Volume Trim (Volume Trim)

Fine-adjusts volume difference between input sources or subwoofer volume.

□ Input Trim (In.Trim)

Corrects volume differences between input sources. If you are bothered by volume differences when switching between input sources, use this function to correct it.



- This setting is applied separately to each input source.

Setting range

-6.0 dB to 0.0 dB to +6.0 dB (0.5 dB increments)

□ Subwoofer Trim (SW.Trim)

Fine-adjusts the subwoofer volume during playback.

Setting range

-6.0 dB to 0.0 dB to +6.0 dB (0.5 dB increments)

■ Lipsync (Lipsync)

Enables/disables the adjustment configured in “Lipsync” (p.59) in the “Setup” menu.



- This setting is applied separately to each input source.

Settings

| | |
|-----------|------------------------------------|
| Off (Off) | Disables the “Lipsync” adjustment. |
| On (On) | Enables the “Lipsync” adjustment. |

■ Signal Info (Signal Info)

Displays information about the video/audio signal.

Choices

| | |
|-------------------|--|
| Format (FORMAT) | Audio format of the input signal |
| Channel (CHAN) | The number of source channels in the input signal (front/surround/LFE) For example, “3/2/0.1” means 3 front channels, 2 surround channels, and LFE. |
| Sampling (SAMPL) | The number of samples per second of the input digital signal |
| Bitrate (B RATE) | The amount of data per second of the input bitstream signal |
| Video In (V IN) | Type and resolution of the input digital signal |
| Video Out (V OUT) | Type and resolution of the output digital signal |



- To switch the information on the front display, press the cursor keys (△/▽) repeatedly.

■ Audio In (Audio In)

Combines the video jack of the selected input source (HDMI 1–4 or AV 1–5) with an audio jack of others. For example, use this function in the following cases.

- Connecting a playback device that supports HDMI video output, but not HDMI audio output
- Connecting a playback device that has component video jacks and analog stereo jacks (such as game consoles)

Input sources

HDMI 1–4, AV 1–5

■ Setup procedure

(To input audio through a digital optical jack)

Select “AV 1” and connect the device to the unit’s corresponding audio jacks with a digital optical cable.

(To input audio through a digital coaxial jack)

Select “AV 2” or “AV 3” and connect the device to the unit’s corresponding audio jacks with a digital coaxial cable.

(To input audio through analog audio jacks)

Select “AV 4”, “AV 5”, or “AUDIO”, and connect the device to the unit’s corresponding audio jacks with a stereo pin cable.

■ Video Out (Video Out)

Selects a video to be output with the selected audio source. For example, you can watch the video while listening to the radio.

Input sources

AUDIO, TUNER, USB, AUX

Settings

| | |
|------------------|--|
| Off (Off) | Does not output video. |
| HDMI 1–4, AV 1–5 | Outputs video input through the corresponding video input jacks. |

CONFIGURATIONS

Configuring various functions (Setup menu)

You can configure the unit's various function with the menu displayed on the TV screen.



- Operations with TV screen are available only when your TV is connected to the unit via HDMI. If not, carry out operations while viewing the front display.

- 1 Press SETUP.**
- 2 Use the cursor keys to select a menu and press ENTER.**

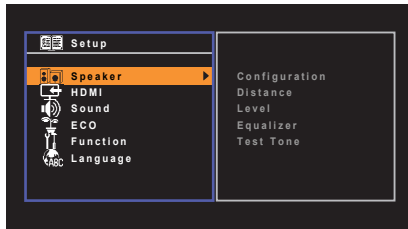

- 3 Use the cursor keys to select an item and press ENTER.**

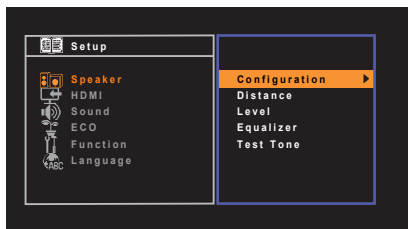

- To return to the previous screen during menu operations, press RETURN.

- 4 Use the cursor keys (</>) to select a setting and press ENTER.**

- 5 To exit from the menu, press SETUP.**

Setup menu items

| Menu | Item | Function | Page | |
|------------------|--|--|--|----|
| Speaker | Configuration | Subwoofer | Selects whether or not a subwoofer is connected. | 54 |
| | | Front | Selects the size of the front speakers. | 54 |
| | | Center | Selects whether or not a center speaker is connected and its size. | 54 |
| | | Surround | Selects whether or not surround speakers are connected and their size. | 54 |
| | | Crossover | Sets the lower limit of the low-frequency component that can be output from speakers whose size is set to "Small". | 54 |
| | | Subwoofer Phase | Sets the phase of the subwoofer. | 55 |
| | | Extra Bass | Enables/disables Extra Bass. | 55 |
| | | Virtual CINEMA FRONT | Selects whether to use the front 5-channel speaker (Virtual CINEMA FRONT) configuration. | 55 |
| | Distance | Sets the distance between each speaker and listening position. | 55 | |
| | Level | Adjusts the volume of each speaker. | 55 | |
| | Equalizer | Adjusts the tone with an equalizer. | 55 | |
| Test Tone | Enables/disables the test tone output. | 56 | | |
| HDMI | Configuration | HDMI Control | Enables/disables HDMI Control. | 57 |
| | | Audio Output | Selects a device to output audio. | 57 |
| | | TV Audio Input | Selects an audio input jack of the unit to be used for TV audio input. | 57 |
| | | Standby Sync | Selects whether to use HDMI control to link the standby behavior of the TV and the unit. | 57 |
| | | ARC | Enables/disables ARC. | 57 |
| | | SCENE | Enables/disables SCENE link playback. | 58 |
| Sound | DSP Parameter | Panorama | Enables/disables the broadening effect of the front sound field. | 59 |
| | | Center Width | Adjusts the broadening effect of the center sound field. | 59 |
| | | Dimension | Adjusts the difference in level between the front and surround sound fields. | 59 |
| | | Center Image | Adjusts the center orientation level (broadening effect) of the front sound field. | 59 |
| | Lipsync | Select | Selects the method to adjust the delay between video and audio output. | 59 |
| | | Adjustment | Adjusts the delay between video and audio output manually. | 59 |
| | Volume | Scale | Switches the scale of the volume display. | 60 |
| | | Dynamic Range | Selects the dynamic range adjustment method for bitstream audio (Dolby Digital and DTS signals) playback. | 60 |
| | | Max Volume | Sets the maximum volume to prevent excessive loudness. | 60 |
| | | Initial Volume | Sets the initial volume for when this receiver is turned on. | 60 |

| Menu | Item | Function | Page |
|-----------------|---------------------------|---|-------------|
| ECO | Auto Power Standby | Set the amount of time for the auto-standby function. | 61 |
| | ECO Mode | Enables/disables the eco mode (power saving mode). | 61 |
| Function | Input Rename | Changes the input source name displayed on the front display. | 62 |
| | Dimmer | Adjusts the brightness of the front display. | 62 |
| | Memory Guard | Prevents accidental changes to the settings. | 62 |
| Language | | Select an on-screen menu language. | 63 |

Speaker

Configures the speaker settings manually.



- Default settings are underlined.

Configuration

Configures the output characteristics of the speakers.



- When you configure the speaker size, select “Large” if the woofer diameter of your speaker is 16 cm (6-1/4”) or larger or “Small” if it is smaller than 16 cm (6-1/4”).

Subwoofer

Selects whether or not a subwoofer is connected.

Settings

| | |
|------------|--|
| <u>Use</u> | Select this option when a subwoofer is connected. The subwoofer will produce LFE (low-frequency effect) channel audio and low-frequency components from other channels. |
| None | Select this option when no subwoofer is connected. The front speakers will produce LFE (low-frequency effect) channel audio and low-frequency components from other channels. |

Front

Selects the size of the front speakers.

Settings

| | |
|--------------|--|
| <u>Small</u> | Select this option for small speakers. The subwoofer will produce front channel low-frequency components (configurable in “Crossover”). |
| Large | Select this option for large speakers. The front speakers will produce all of the front channel frequency components. |



- “Front” is automatically set to “Large” when “Subwoofer” is set to “None”.

Center

Selects whether or not a center speaker is connected and its size.

Settings

| | |
|--------------|---|
| <u>Small</u> | Select this option for small speakers. The subwoofer or front speakers will produce center channel low-frequency components (configurable in “Crossover”). |
| Large | Select this option for large speakers. The center speaker will produce all of the center channel frequency components. |
| None | Select this option when no center speaker is connected. The front speakers will produce center channel audio. |

Surround

Selects whether or not surround speakers are connected and their sizes.

Settings

| | |
|--------------|--|
| <u>Small</u> | Select this option for small speakers. The subwoofer or front speakers will produce surround channel low-frequency components (configurable in “Crossover”). |
| Large | Select this option for large speakers. The surround speakers will produce all of the surround channel frequency components. |
| None | Select this option when no surround speakers are connected. The front speakers will produce surround channel audio. Virtual CINEMA DSP works when you select a sound program. |

Crossover

Sets the lower limit of the low-frequency components that can be output from a speaker whose size is set to “Small”. A frequency sound lower than the specified value will be produced from the subwoofer or front speakers

Settings

40 Hz, 60 Hz, 80 Hz, 90 Hz, 100 Hz, 110 Hz, 120 Hz, 160 Hz, 200 Hz



- If the volume and crossover frequency are adjustable on your subwoofer, set the volume to half and crossover frequency to maximum.

Subwoofer Phase

Sets the phase of the subwoofer. When the bass sound is lacking or unclear, switch the subwoofer phase.

Settings

| | |
|---------------|---------------------------------------|
| <u>Normal</u> | Does not reverse the subwoofer phase. |
| Reverse | Reverses the subwoofer phase. |

Extra Bass

Enables/disables Extra Bass. When Extra Bass is enabled, you can enjoy enhanced bass sounds, regardless of the size of the front speakers and the presence or absence of the subwoofer.

Settings

| | |
|------------|----------------------|
| <u>Off</u> | Disables Extra Bass. |
| On | Enables Extra Bass. |



- You can also use BASS on the remote control to enable/disable Extra Bass (p.36).

Virtual CINEMA FRONT

Selects whether to use the front 5-channel speaker (Virtual CINEMA FRONT) configuration.

Settings

| | |
|------------|---|
| <u>Off</u> | Disables the front 5-channel speaker configuration. |
| On | Enables the front 5-channel speaker configuration. |



- Select "On" only when utilizing the Virtual CINEMA FRONT configuration (p.13).
- This setting is not available when "Surround" is set to "None".

Distance

Sets the distance between each speaker and listening position so that sounds from the speakers reach the listening position at the same time. First, select the unit of distance from "Meter" or "Feet".

Choices

Front L, Front R, Center, Surround L, Surround R, Subwoofer

Setting range

0.30 m to 24.00 m (1.0 ft to 80.0 ft), 0.05 m (0.2 ft) increments

Default

Front L, Front R, Subwoofer: 3.00 m (10.0 ft)

Center: 2.60 m (8.6 ft)

Surround L, Surround R: 2.40 m (8.0 ft)

Level

Adjusts the volume of each speaker.

Choices

Front L, Front R, Center, Surround L, Surround R, Subwoofer

Setting range

-10.0 dB to +10.0 dB (0.5 dB increments)

Default

Front L, Front R, Subwoofer: 0.0 dB

Others: -1.0 dB

Equalizer

Adjusts the tone with an equalizer.

EQ Select

Selects the type of equalizer to be used.

Settings

| | |
|------------|--|
| <u>PEQ</u> | Applies the parametric equalizer values obtained by the YPAO measurement (p.26). |
| <u>GEQ</u> | Select this option when you want to adjust the equalizer manually. For details, see "Manual equalizer adjustment". |
| Off | Does not use the equalizer. |



- "PEQ" is available only when the YPAO has been performed (p.26).

Manual equalizer adjustment

- 1 Set “EQ Select” to “GEQ”.
- 2 Use the cursor keys (Δ/∇) to select “Channel” and the cursor keys (\leftarrow/\rightarrow) to select the desired speaker channel.
- 3 Use the cursor keys (Δ/∇) to select the desired band (frequency) and the cursor keys (\leftarrow/\rightarrow) to adjust the gain.

Setting range

-6.0 dB to +6.0 dB

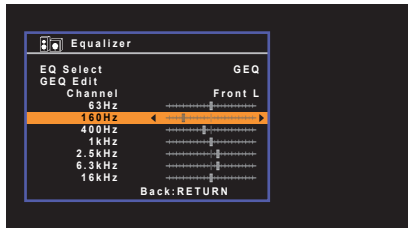

- 4 To exit from the menu, press **SETUP**.

Test Tone

Enables/disables the test tone output. Test tone output helps you to adjust the speaker balance or equalizer while confirming its effect.

Settings

| | |
|-----|--|
| Off | Does not output test tones. |
| On | Outputs test tones automatically when you adjust the speaker balance or equalizer. |

HDMI

Configures the HDMI settings.



- Default settings are underlined.

■ Configuration

HDMI Control

Enables/disables HDMI Control (p.76).

Settings

| | |
|------------|--|
| <u>Off</u> | Disables HDMI Control. |
| On | Enables HDMI Control. Configure the settings in "TV Audio Input", "Standby Sync", "ARC", and "SCENE". |



- To use HDMI control, you need to perform the HDMI Control link setup (p.76) after connecting HDMI Control-compatible devices.

Audio Output

Selects a device to output audio.



- This setting is available only when "HDMI Control" is set to "Off".

Amp

Enables/disables the audio output from the speakers connected to the unit.

Settings

| | |
|------------|--|
| <u>Off</u> | Disables the audio output from the speakers. |
| <u>On</u> | Enables the audio output from the speakers. |

HDMI OUT (TV)

Enables/disables the audio output from a TV connected to the HDMI OUT jack.

Settings

| | |
|------------|--|
| <u>Off</u> | Disables the audio output from the TV. |
| On | Enables the audio output from the TV. |

TV Audio Input

Selects an audio input jack of the unit to be used for TV audio input when "HDMI Control" is set to "On". The unit's input source automatically switches to TV audio when the TV input is switched to its built-in tuner.

Settings

AV 1-5, AUDIO

Default

AV 4



- When using ARC to input TV audio to the unit, you cannot use the input jacks selected here for connecting an external device because the input will be used for TV audio input.

Standby Sync

Select whether to use HDMI control to link the standby behavior of the TV and the unit when "HDMI Control" is set to "On".

Settings

| | |
|-------------|---|
| Off | Does not set the unit to standby mode when the TV is turned off. |
| On | Sets the unit to standby mode when the TV is turned off. |
| <u>Auto</u> | Sets the unit to standby mode when the TV is turned off only when the unit is receiving TV audio or HDMI signals. |

ARC

Enables/disables ARC (p.18) when "HDMI Control" is set to "On".

Settings

| | |
|-----------|---------------|
| Off | Disables ARC. |
| <u>On</u> | Enables ARC. |



- You do not need to change this setting normally. In case noises are produced from the speakers connected to the unit because TV audio signals input to the unit via ARC are not supported by the unit, set "ARC" to "Off" and use the TV's speakers.

SCENE

Enables/disables SCENE link playback when "HDMI Control" is set to "On".

When SCENE link playback is enabled, HDMI Control-compatible devices connected to the unit via HDMI automatically work as follows, with a scene selection.

- TV: turning on and displaying video from the playback device
- Playback device: starting playback

Choices (SCENE keys)

BD/DVD, TV, CD, RADIO

Settings

| | |
|-----|--|
| Off | Disables SCENE link playback for the selected SCENE key. |
| On | Enables SCENE link playback for the selected SCENE key. |

Default

BD/DVD, TV: On

CD, RADIO: Off



- SCENE link playback may not work properly due to the compatibility between devices. We recommend using TV and playback devices from the same manufacturer so that HDMI Control works more effectively.

Sound

Configures the audio output settings.



- Default settings are underlined.

DSP Parameter

Configures the surround decoder settings.

Panorama

Enables/disables the broadening effect of the front sound field. When this function is enabled, you can wrap front right/left channel sounds around the field and generate a spacious sound field in combination with the surround sound field. This setting is effective when “**DOL**PLII Music” is selected.

Settings

| | |
|------------|--|
| <u>Off</u> | Disables the broadening effect of the front sound field. |
| On | Enables the broadening effect of the front sound field. |

Center Width

Adjusts the broadening effect of the center sound field. Higher to enhance the broadening effect, and lower to reduce it (closer to center). This setting is effective when “**DOL**PLII Music” is selected.

Setting range

0 to 3 to 7

Dimension

Adjusts the difference in level between the front and surround sound fields. Higher to strengthen the front sound field and lower to strengthen the surround sound field. This setting is effective when “**DOL**PLII Music” is selected.

Setting range

-3 to 0 to +3

Center Image

Adjusts the center orientation level (broadening effect) of the front sound field. Higher to strengthen the center orientation level (less broadening effect) and lower to weaken (more broadening effect). This setting is effective when “Neo:6 Music” is selected.

Setting range

0.0 to 0.3 to 1.0

Lipsync

Adjusts the delay between video and audio output.



- You can enable/disable the Lipsync function by input sources in “Lipsync” (p.50) in the “Option” menu.

Select

Selects the method to adjust the delay between video and audio output.

Setting range

| | |
|---------------|---|
| <u>Manual</u> | Select this option when you want to adjust the delay between video and audio output manually. Adjust the audio output timing in “Adjustment”. |
| <u>Auto</u> | Adjusts the delay between video and audio output automatically when a TV that supports an automatic lipsync function is connected to the unit via HDMI. If necessary, you can fine-adjust the audio output timing in “Adjustment”. |



- “Select” is automatically set to “Manual” depending on the TV connected to the unit.

Adjustment

Adjusts the delay between video and audio output manually when “Select” is set to “Manual”. You can fine-adjust the audio output timing when “Select” is set to “Auto”.

Setting range

0 ms to 500 ms (1 ms increments)

■ Volume

Configures the volume settings.

Scale

Switches the scale of the volume display.

Settings

| | |
|-----------|---|
| <u>dB</u> | Displays the volume in the “dB” unit. |
| 0-97 | Displays the volume in the numeric value (0.5 to 97.0). |

Dynamic Range

Selects the dynamic range adjustment method for bitstream audio (Dolby Digital and DTS signals) playback.

Settings

| | |
|----------------|--|
| <u>Maximum</u> | Produces audio without adjusting the dynamic range. |
| Standard | Optimizes the dynamic range for regular home use. |
| Min/Auto | Sets the dynamic range for clear sound even at night or at low volumes. When playing back Dolby TrueHD signals, the dynamic range is automatically adjusted based on the input signal information. |

Max Volume

Sets the maximum volume to prevent excessive loudness.

Setting range

-30.0 dB to +15.0 dB (5.0 dB increments), +16.5 dB
[50.0 to 95.0 (5.0 increments), 97.0]

Initial Volume

Sets the initial volume when the receiver is turned on.

Settings

| | |
|--|---|
| <u>Off</u> | Sets the level to the volume level of the unit when it last entered standby mode. |
| Mute | Sets the unit to mute the audio output. |
| -80.0 dB to +16.5 dB (0.5 dB increments) [0.5 to 97.0 (0.5 increments)] | Sets the level to the specified volume level. |

ECO

Configures the power supply settings.



- Default settings are underlined.

■ Auto Power Standby

Set the amount of time for the auto-standby function.

Settings

| | |
|-------------------------------------|--|
| <u>Off</u> | Does not set the unit to standby mode automatically. |
| 20 minutes | Sets the unit to standby mode when you have not operated the unit and the unit has not detected any input signal for the specified time. |
| 2 hours, 4 hours, 8 hours, 12 hours | Sets the unit to standby mode when you have not operated the unit for the specified time. |

Default

U.K. and Europe models: 20 minutes

Other models: Off



- Just before the unit enters standby mode, “AutoPowerStdby” appears and then countdown starts in the front display.

■ ECO Mode

Enables/disables the eco (power saving) mode.

When the eco mode is enabled, you can reduce the unit's power consumption by keeping the maximum volume, maximum output power, or front display's brightness low.

Settings

| | |
|------------|------------------------|
| <u>Off</u> | Disables the eco mode. |
| On | Enables the eco mode. |



- Be sure to press ENTER to restart the unit after selecting a setting. The new setting will take effect after the unit is restarted.

Function

Configures the functions that make the unit easier to use.



- Default settings are underlined.

Input Rename

Changes the input source name displayed on the front display.

Input sources

HDMI 1-4, AV 1-5, AUDIO, USB, AUX

Procedure

- 1 Use the cursor keys (Δ/∇) to select an input source to be renamed and press ENTER.



- To select a name from the presets, use the cursor keys (Δ/∇) to select an input source and the cursor keys (\leftarrow/\rightarrow) to select a preset name.

- 2 Use the cursor keys (\leftarrow/\rightarrow) to move the edit position and the cursor keys (Δ/∇) to select a character.

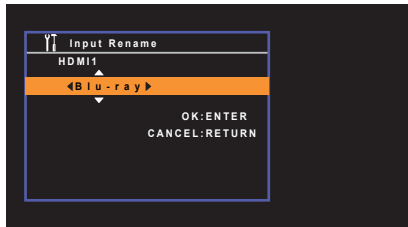

- 3 To confirm the new name, press ENTER.



- To cancel the entry, press RETURN.

- 4 To change another input source name, repeat steps 1 to 3.

- 5 To exit from the menu, press SETUP.

Dimmer

Adjusts the brightness of the front display.

Setting range

-4 to 0 (higher to brighten)



- The front display may become dark when "ECO Mode" (p.61) is set to "On".

Memory Guard

Prevents accidental changes to the settings.

Settings

| | |
|------------|--|
| <u>Off</u> | Does not protect the settings. |
| On | Protects the settings until "Off" is selected. |



- When "Memory Guard" is set to "On", the following icon () is displayed on the menu screen.

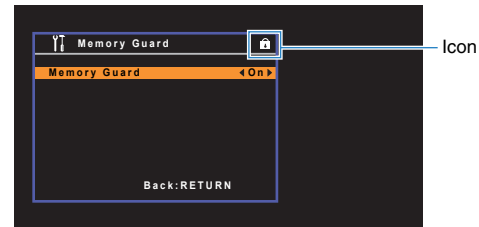

Language

Select an on-screen menu language.



- Default settings are underlined.

Settings

| | |
|----------------|----------|
| <u>English</u> | English |
| 日本語 | Japanese |
| Français | French |
| Deutsch | German |
| Español | Spanish |
| Русский | Russian |
| Italiano | Italian |
| 中文 | Chinese |



- Japanese and Chinese characters used in content information (such as song titles) cannot be displayed.
- The information on the front display is provided in English only.

Configuring the system settings (ADVANCED SETUP menu)

Configure the system settings of the unit while viewing the front display.

- 1 Set the unit to standby mode.
- 2 While holding down **STRAIGHT** on the front panel, press **⏻** (power).

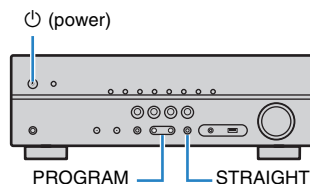

- 3 Press **PROGRAM** to select an item.
- 4 Press **STRAIGHT** to select a setting.
- 5 Press **⏻** (power) to set the unit to standby mode and turn it on again.
The new settings take effect.

ADVANCED SETUP menu items



- Default settings are underlined.

| Item | Function | Page |
|-----------|---|------|
| SP IMP. | (U.S.A. and Canada models only) Changes the speaker impedance setting. | 64 |
| REMOTE ID | Selects the unit's remote control ID. | 65 |
| TU | (Asia, Taiwan and General models only) Changes the FM/AM tuning frequency setting. | 65 |
| TV FORMAT | Switches the video signal type of HDMI output. | 65 |
| INIT | Restores the default settings. | 65 |
| UPDATE | Updates the firmware. | 66 |
| VERSION | Checks the version of firmware currently installed on the unit. | 66 |

Changing the speaker impedance setting (SP IMP.)

(U.S.A. and Canada models only)



Change the unit's speaker impedance settings depending on the impedance of the speakers connected.

Settings

| | |
|----------------|--|
| <u>6 Ω MIN</u> | Select this option when you connect 6-ohm speakers to the unit. You can also use 4-ohm speakers as the front speakers. |
| <u>8 Ω MIN</u> | Select this option when you connect 8-ohm or higher speakers to the unit. |

Selecting the remote control ID (REMOTE ID)

REMOTE ID * * ID1

Change the unit's remote control ID so that it matches the remote control's ID (default: ID1). When using multiple Yamaha AV receivers, you can set each remote control with a unique remote control ID for its corresponding receiver.

Settings

ID1, ID2

■ Changing the remote control ID of the remote control

- 1 To select ID1, hold down the cursor key (◀) and SCENE (BD/DVD) together for 3 seconds.
To select ID2, hold down the cursor key (◀) and SCENE (TV) together for 3 seconds.

Changing the FM/AM tuning frequency setting (TU)

(Asia, Taiwan and General models only)

TU * * * FM50/AM9

Change the FM/AM tuning frequency setting of the unit depending on your listening environment.

Settings

| | |
|------------|---|
| FM100/AM10 | Select this when you want to adjust the FM frequency by 100-kHz steps and AM by 10-kHz steps. |
| FM50/AM9 | Select this when you want to adjust the FM frequency by 50-kHz steps and AM by 9-kHz steps. |

Switching the video signal type (TV FORMAT)

TV FORMAT * NTSC

Switch the video signal type of HDMI output so that it matches to the format of your TV. Since the unit automatically selects the video signal type so that it matches to the TV, it is unnecessary to change the setting normally. Change the setting only when images on the TV screen do not appear correctly.

Settings

NTSC, PAL

Default

U.S.A., Canada, Korea, Taiwan and General models: NTSC

Other models: PAL

Restoring the default settings (INIT)

INIT * * * * CANCEL

Restores the default settings for the unit.

Choices

| | |
|--------|---|
| ALL | Restores the default settings for the unit. |
| CANCEL | Does not perform an initialization. |

Updating the firmware (UPDATE)

A black rectangular LCD display showing the word "UPDATE" in white, pixelated font. To the right of "UPDATE" are four small white dots, followed by the text "USB" in the same font.

New firmware that provides additional features or product improvements will be released as needed. Updates can be downloaded from our website. For details, refer to the information supplied with updates.

■ Firmware update procedure

Do not perform this procedure unless firmware update is necessary. Also, make sure you read the information supplied with updates before updating the firmware.

- 1 Save the downloaded firmware to the root folder of a USB memory device.**
- 2 Press PROGRAM on the front panel to select “UPDATE”.**
- 3 Connect the USB memory device to the USB jack.**
- 4 To start firmware update, press INFO on the front panel.**

Checking the firmware version (VERSION)

A black rectangular LCD display showing the word "VERSION" in white, pixelated font. To the right of "VERSION" are two small white dots, followed by the text "xx.xx" in the same font.

Check the version of firmware currently installed on the unit.

APPENDIX

Frequently asked questions

The new speaker system does not provide an ideal sound balance...

If you have changed speakers or have a new speaker system, use YPAO to optimize the speaker settings again (p.26). If you want to adjust the speaker settings manually, use "Speaker" in the "Setup" menu (p.54).

Since we have small children, we want to set limitations on the volume control...

If a small child accidentally operates the controls on the main unit or remote control, the volume may suddenly increase. This may also cause injury or damage the unit or speakers. We recommend using "Max Volume" in the "Setup" menu to set the maximum volume level for the unit in advance (p.60).

I am occasionally startled by a sudden loud sound when turning on the unit...

By default, the volume level when the unit last entered standby mode is automatically applied. If you want to fix the volume, use "Initial Volume" in the "Setup" menu to set the volume to be applied when the receiver is turned on (p.60).

We are bothered by volume differences when switching between input sources...

You can correct volume differences between input sources by utilizing "Input Trim" in the "Option" menu (p.49).

I made HDMI connections but HDMI Control does not work at all...

To use HDMI Control, you need to perform the HDMI Control link setup (p.76). After connecting HDMI Control-compatible devices (such as BD/DVD players) to the unit, enable HDMI Control on each device and perform the HDMI Control link setup. This setup is required every time you add a new HDMI Control-compatible device to your system. For information on how HDMI Control works between your TV and playback devices, refer to the instruction manuals for each device.

I want to display a device name or a manufacture name on the front display when selecting an input source...

By default, input source names (such as "HDMI 1" and "AV 1") are displayed on the front display when an input source is selected. If you want to rename them as you like, use "Input Rename" (p.62) in the "Setup" menu. You can also select a name from the presets (such as "Blu-ray" and "DVD").

I want to prevent accidental changes to the settings...

You can protect the settings configured on the unit (such as speaker settings) by utilizing "Memory Guard" in the "Setup" menu (p.62).

The unit's remote control is simultaneously controlling another Yamaha product as well as the unit...

When using multiple Yamaha products, the remote control may work on another Yamaha product or another remote control may work on the unit. If this happens, register different remote control IDs for the devices that you want to control with each remote control (p.65).

Troubleshooting

Refer to the table below when the unit does not function properly.

If the problem you are experiencing is not listed below or if the instructions below do not help, turn off the unit, disconnect the power cable, and contact the nearest authorized Yamaha dealer or service center.

First, check the following:

- ① **The power cables of the unit, TV and playback devices (such as BD/DVD players) are connected to AC wall outlets securely.**
- ② **The unit, subwoofer, TV and playback devices (such as BD/DVD players) are turned on.**
- ③ **The connectors of each cable are securely inserted in to jacks on each device.**

Power, system and remote control

| Problem | Cause | Remedy |
|--|--|--|
| The power does not turn on. | The protection circuitry has been activated three times consecutively. | As a safety precaution, capability to turn on the power is disabled. Contact your nearest Yamaha dealer or service center to request repair. |
| The power does not turn off. | The internal microcomputer has frozen, due to an external electric shock (such as lightning or excessive static electricity) or to a drop in the power supply voltage. | Hold down \odot (power) on the front panel for more than 10 seconds to reboot the unit. (If the problem persists, disconnect the power cable from the AC wall outlet and plug it again.) |
| The power turns off (standby mode) immediately. | The unit was turned on while a speaker cable was shorted. | Twist the bare wires of each speaker cable firmly and reconnect to the unit and speakers (p.15). |
| The unit enters standby mode automatically. | The sleep timer worked. | Turn on the unit and start playback again. |
| | The auto-standby function kicked in because the unit was not used for the specified time. | To disable the auto-standby function, set "Auto Power Standby" in the "Setup" menu to "Off" (p.61). |
| | The speaker impedance setting is incorrect. | Set the speaker impedance to match your speakers (p.64). |
| | The protection circuitry has been activated because of a short circuit. | Twist the bare wires of each speaker cable firmly and reconnect to the unit and speakers (p.15). |
| The unit is not reacting. | The internal microcomputer is frozen, due to an external electric shock (such as lightning or excessive static electricity) or to a drop in the power supply voltage. | Hold down \odot (power) on the front panel for more than 10 seconds to reboot the unit. (If the problem persists, disconnect the power cable from the AC wall outlet and plug it again.) |
| The unit cannot be controlled using the remote control. | The unit is out of the operating range. | Use the remote control within the operating range (p.4). |
| | The batteries are weak. | Replace with new batteries. |
| | The unit's remote control sensor is exposed to direct sunlight or strong lighting. | Adjust the lighting angle, or reposition the unit. |
| | The remote control IDs of the unit and the remote control are not identical. | Change the remote control ID of the unit or the remote control (p.65). |

Audio

| Problem | Cause | Remedy |
|---|--|---|
| No sound. | Another input source is selected. | Select an appropriate input source with the input selection keys. |
| | Signals that the unit cannot reproduce are being input. | Some digital audio formats cannot be played back on the unit. To check the audio format of the input signal, use "Signal Info" in the "Option" menu (p.50). |
| | The cable connecting the unit and playback device is defective. | If there is no problem with the connection, replace with another cable. |
| The volume cannot be increased. | The maximum volume is set. | Use "Max Volume" in the "Setup" menu to adjust the maximum volume (p.60). |
| | A device connected to the output jacks of the unit is not turned on. | Turn on all devices connected to the output jacks of the unit. |
| No sound is coming from a specific speaker. | The playback source does not contain a signal for the channel. | To check it, use "Signal Info" in the "Option" menu (p.50). |
| | The currently selected sound program/decoder does not use the speaker. | To check it, select "5ch Stereo" (p.32). |
| | Audio output of the speaker is disabled. | Perform YPAO (p.26) or use "Configuration" in the "Setup" menu to change the speaker settings (p.54). |
| | The volume of the speaker is set too low. | Perform YPAO (p.26) or use "Level" in the "Setup" menu to adjust the speaker volume (p.55). |
| | The speaker cable connecting the unit and the speaker is defective. | If there is no problem with the connection, replace with another speaker cable. |
| | The speaker is malfunctioning. | To check it, replace with another speaker. If the problem persists, the unit may be malfunctioning. |
| No sound is coming from the subwoofer. | The playback source does not contain LFE or low-frequency signals. | To check it, set "Extra Bass" in the "Setup" menu to "On", in order to output the front channel low-frequency components from the subwoofer (p.55). |
| | Subwoofer output is disabled. | Perform YPAO (p.26) or set "Subwoofer" in the "Setup" menu to "Use" (p.54). |
| | The volume of the subwoofer is too low. | Adjust the volume on the subwoofer. |
| | The subwoofer has been turned off by its auto-standby function. | Disable the auto-standby function of the subwoofer or adjust its sensitivity level. |
| No sound from the playback device (connected to the unit with HDMI). | The TV does not support HDCP (High-bandwidth Digital Content Protection). | Refer to the instruction manuals for the TV and check the TV's specifications. |
| | The unit is set not to output audio input through HDMI jacks from the SPEAKERS terminals. | In "Audio Output" in the "Setup" menu, set "Amp" to "On" (p.57). |
| | The number of devices connected to the HDMI OUT jack exceeds the limit. | Disconnect some of the HDMI devices. |
| No sound from the TV (when HDMI Control is used). | The TV is set to output audio from the TV speakers. | Change the audio output setting on your TV so that the TV audio is output from the speakers connected to the unit. |
| | A TV that does not support ARC is connected to the unit only with an HDMI cable. | Use a digital optical cable to make an audio connection (p.20). |
| | (If the TV is connected to the unit with an audio cable) The TV audio input setting does not match the actual connection. | Use "TV Audio Input" in the "Setup" menu to select the correct audio input jack (p.57). |
| | (If you are trying to use ARC) ARC is disabled on the unit or TV. | Set "ARC" in the "Setup" menu to "On" (p.57). Also, enable ARC on the TV. |

| Problem | Cause | Remedy |
|--|--|---|
| Only the front speakers work on multichannel audio. | The playback device is set to output 2-channel audio (such as PCM) only. | To check it, use "Signal Info" in the "Option" menu (p.50). If necessary, change the digital audio output setting on the playback device. |
| Noise/hum is heard. | The unit is too close to another digital or radio frequency device. | Move the unit further away from the device. |
| | The cable connecting the unit and playback device is defective. | If there is no problem with the connection, replace with another cable. |
| The sound is distorted. | A device connected to the unit's output jacks is not turned on. | Turn on all devices connected to the unit's output jacks. |
| | The volume of the unit is too high. | Turn down the volume. If "ECO Mode" in the "Setup" menu is set to "On", set it to "Off" (p.61). |

Video

| Problem | Cause | Remedy |
|---|---|---|
| No video. | Another input source is selected on the unit. | Select an appropriate input source with the input selection keys. |
| | Another input source is selected on the TV. | Switch the TV input to display the video from the unit. |
| | The video signal output from the unit is not supported by the TV. | Check the video output setting of the playback device. For information about video signals supported by the TV, refer to the instruction manuals for the TV. |
| | The cable connecting the unit and TV (or playback device) is defective. | If there is no problem with the connection, replace with another cable. |
| No video from the playback device (connected to the unit with HDMI). | The input video signal (resolution) is not supported by the unit. | To check the information about the current video signal (resolution), use "Signal Info" in the "Option" menu (p.50). For information about video signals supported by the unit, see "HDMI signal compatibility" (p.78). |
| | The TV does not support HDCP (High-bandwidth Digital Content Protection). | Refer to the instruction manuals for the TV and check the TV's specifications. |
| | The number of devices connected to the HDMI OUT jack is over the limit. | Disconnect some of the HDMI devices. |
| The menu of the unit is not displayed on the TV. | The TV is not connected to the unit via HDMI. | You can display the menu of the unit on the TV only when they are connected with an HDMI cable. If necessary, use an HDMI cable to connect them (p.18 to 20). |
| | Another input source is selected on the TV. | Switch the TV input to display the video from the unit (HDMI OUT jack). |

FM/AM radio

| Problem | Cause | Remedy |
|---|--|--|
| FM radio reception is weak or noisy. | There is multi-path interference. | Adjust the FM antenna height or orientation, or place it in a different location. |
| | Your area is too far from the FM station transmitter. | Press MODE to select monaural FM radio reception (p.37). Use an outdoor FM antenna. We recommend using a sensitive multi-element antenna. |
| AM radio reception is weak or noisy. | The noises may be caused by fluorescent lamps, motors, thermostats, or other electrical equipment. | It is difficult to completely eliminate noise. It may be reduced by using an outdoor AM antenna. |
| Radio stations cannot be selected automatically. | Your area is too far from the FM station transmitter. | Select the station manually (p.37). Use an outdoor antenna. We recommend using a sensitive multi-element antenna. |
| | The AM radio signal is weak. | Adjust the AM antenna orientation. Select the station manually (p.37). Use an outdoor AM antenna. Connect it to the ANTENNA (AM) jack together with the supplied AM antenna. |
| AM radio stations cannot be registered as presets. | Auto Preset has been used. | Auto Preset is for registering FM radio stations only. Register AM radio stations manually (p.38). |

USB

| Problem | Cause | Remedy |
|--|--|--|
| The unit does not detect the USB device. | The USB device is not connected to the USB jack securely. | Turn off the unit, reconnect your USB device, and turn the unit on again. |
| | The file system of the USB device is not FAT 16 or FAT 32. | Use a USB device with FAT 16 or FAT 32 format, except USB HDDs. |
| Folders and files in the USB device cannot be viewed. | The folder structure not supported by the unit is applied. | The unit supports folder hierarchies of up to eight levels and up to 65,000 files per level. If necessary, modify the folder structure on your USB device. |

Error indications on the front display

| Message | Cause | Remedy |
|-----------------------|--|---|
| Access error | The unit cannot access the USB device. | Turn off the unit and reconnect your USB device. If the problem persists, try another USB device. |
| | The unit cannot access the iPod. | Turn off the iPod and turn it on again. |
| Check SP Wires | The speaker cables short circuit. | Twist the bare wires of the cables firmly and connect to the unit and speakers properly. |
| Connect error | The unit has detected the iPod, but cannot access it. | Turn off the iPod and then turn it on again. |
| Internal Error | An internal error has occurred. | Contact the nearest authorized Yamaha dealer or service center. |
| No content | There are no playable files in the selected folder. | Select a folder that contains files supported by the unit. |
| RemID Mismatch | The remote control IDs of the unit and the remote control are not identical. | Change the remote control ID of the unit or the remote control (p.65). |
| Unable to play | The unit cannot play back the songs stored on the iPod for some reason. | Check the song data. If it cannot be played on the iPod itself, the song data or storage area may be defective. |
| Unknown iPod | The connected iPod is not supported by the unit. | Use an iPod supported by the unit (p.41). |

Audio information

■ Audio decoding format

Dolby Digital

Dolby Digital is a compressed digital audio format developed by Dolby Laboratories, Inc. that supports 5.1-channel audio. This technology is used for audio on most DVD discs.

Dolby Pro Logic II

Dolby Pro Logic II enables 5-channel playback from 2-channel sources. There are three modes available: "Music mode" for music sources, "Movie mode" for movie sources, and "Game mode" for game sources.

Dolby TrueHD

Dolby TrueHD is an advanced lossless audio format developed by Dolby Laboratories, Inc. to offer a high-definition home theater experience with the quality of the studio master. Dolby TrueHD can carry up to eight channels of 96 kHz/24-bit audio (up to six channels of 192 kHz/24-bit audio) simultaneously. This technology is used for audio on BD (Blu-ray discs).

DTS 96/24

DTS 96/24 is a compressed digital audio format that supports 5.1-channel and 96 kHz/24-bit audio. This format remains fully compatible with the existing multichannel audio systems that support DTS Digital Surround. This technology is used for music DVDs, etc.

DTS Digital Surround

DTS Digital Surround is a compressed digital audio format developed by DTS, Inc. that supports 5.1-channel audio. This technology is used for audio on most DVD discs.

DTS-ES

DTS-ES creates total 6.1-channel audio from 5.1-channel sources that are recorded with DTS-ES. This decoder adds a surround back sound to the original 5.1-channel sound. In the DTS-ES Matrix 6.1 format, a surround back sound is recorded in the surround channels, and in the DTS-ES Discrete 6.1 format, a discrete surround back channel is recorded.

DTS Express

DTS Express is a compressed digital audio format that supports 5.1-channel audio and allows a higher compression rate than the DTS Digital Surround format developed by DTS, Inc. This technology is developed for audio streaming services on the Internet and secondary audio on BD (Blu-ray discs).

DTS-HD High Resolution Audio

DTS-HD High Resolution Audio is a compressed digital audio format developed by DTS, Inc. that supports 7.1-channel and 96 kHz/24-bit audio. DTS-HD High Resolution Audio remains fully compatible with the existing multichannel audio systems that support DTS Digital Surround. This technology is used for audio on most BD (Blu-ray discs).

DTS-HD Master Audio

DTS-HD Master Audio is an advanced lossless audio format developed to offer a high-definition home theater experience with the quality of the studio master by DTS, Inc. DTS-HD Master Audio can carry up to eight channels of 96 kHz/24-bit audio (up to six channels of 192 kHz/24-bit audio) simultaneously. This technology is used for audio on BD (Blu-ray discs).

DTS Neo:6

DTS Neo:6 enables 6-channel playback from 2-channel sources. There are two modes available: "Music mode" for music sources and "Cinema mode" for movie sources. This technology provides discrete full-bandwidth matrix channels of surround sound.

DSD (Direct Stream Digital)

DSD (Direct Stream Digital) technology stores audio signals on digital storage media, such as SACD (Super Audio CDs). The signals are stored at a high-frequency sampling rate of 2.8224 MHz. The highest frequency response is equal to or higher than 100 kHz, with a dynamic range of 120 dB. This technology offers better audio quality than that used for CDs.

MP3

One of the compressed digital audio format used by MPEG. With psychoacoustic technologies, this compression method achieves a high compression rate. Reportedly, it is capable of compressing data quantity by about 1/10 maintaining a certain level of audio quality.

MPEG-4 AAC

An MPEG-4 audio standard. It is used for mobile telephones, portable audio players, and audio streaming services on Internet because it allows a high compression rate of data while maintaining better audio quality than MP3.

PCM (Pulse Code Modulation)

PCM is a signal format under which an analog audio signal is digitized, recorded, and transmitted. This technology is the basis of all other audio format. This technology is used as a lossless audio format called Linear PCM for audio on a variety of media, including CDs and Blu-ray discs.

Sampling frequency/Quantization bit

Sampling frequency and quantization bits indicate the quantity of information when an analog audio signal is digitized. These values are noted as in the following example: "48 kHz/24-bit".

- Sampling frequency
Sampling frequency (the number of times the signal is sampled per second) is called the sampling rate. When the sampling frequency is higher, the range of frequencies that can be played back are wider.
- Quantization bit
The number of quantization bits indicate the degree of accuracy when converting the sound level into a numeric value. When the number of quantized bits is higher, the expression of the sound level is more accurate.

WAV

Windows standard audio file format, which defines the method of recording the digital data obtained by converting audio signals. By default, the PCM method (no compression) is used, but you can also use other compression methods.

WMA (Windows Media Audio)

One of the compressed digital audio formats developed by Microsoft Corporation. With psychoacoustic technologies, this compression method achieves a high compression rate. Reportedly, it is capable of compressing data quantity by about 1/20 maintaining a certain level of audio quality.

Others

LFE (Low Frequency Effects) 0.1 channel

This channel reproduces low-frequency bass signals and has a frequency range from 20 Hz to 120 Hz. This channel is added to the channels for all bands with Dolby Digital or DTS to enhance low frequency audio effects. This channel is labeled 0.1 because it is limited to only low frequency audio.

Lip sync

Video output sometimes lags behind audio output due to the complexity of signal processing caused by an increase in video signal capacity. Lip sync is a technique for automatically correcting the timing lag between audio and video output.

HDMI and video information

Component video signal

With the component video signal system, the video signal is separated into the Y signal for luminance and the Pb and Pr signals for chrominance. Color can be reproduced more faithfully with this system because each of these signals is independent.

Composite video signal

With the composite video signal system, color, brightness, and synchronization data signals are combined and transmitted with a single cable.

Deep Color

Deep Color is a technology that HDMI specification supports. Deep Color increases the number of available colors within the boundaries defined by the RGB or YCbCr color space. Conventional color systems process the color using 8 bits. Deep Color processes the color with 10, 12, or 16 bits. This technology allows HDTVs and other displays to increase from millions of colors to billions of colors and eliminate on-screen color banding for smooth tonal transitions and subtle gradations between colors.

HDMI

HDMI (High-Definition Multimedia Interface) is the world-wide standard interface for digital audio/video signal transmission. This interface transmits both digital audio and digital video signals using a single cable without any loss. HDMI complies with HDCP (High-bandwidth Digital Content Protection) and provides a secure audio/video interface. For further information on HDMI, visit the HDMI website at "<http://www.hdmi.org/>".

x.v.Color

"x.v.Color" is a technology that the HDMI specification supports. It is a more extensive color space than sRGB and allows the expression of colors that were not hitherto possible. While remaining compatible with the color gamut of sRGB standards, "x.v.Color" expands the color space, and thus can produce more vivid, natural images.

Yamaha technologies

CINEMA DSP (Digital Sound Field Processor)

Since the Dolby Surround and DTS systems were originally designed for use in movie theaters, their effect is best experienced in a theater that has many speakers designed for acoustic effects. Since home conditions (such as room size, wall material, and number of speakers) can differ so widely, it is inevitable that there are differences in the sound that you hear. Based on a wealth of actually measured data, CINEMA DSP, Yamaha's original DSP technology provides the audiovisual experience of a movie theater in your own home.

Compressed Music Enhancer

The Compressed Music Enhancer feature compensates for missing harmonics in compression music formats (such as MP3). As a result, this technology provides improved performance for the overall sound system.

SILENT CINEMA

Yamaha has developed a natural, realistic sound effect DSP algorithm for headphones. Parameters for headphones have been set for each sound program, so that accurate representations of all the sound programs can be enjoyed on headphones.

Virtual CINEMA DSP

Virtual CINEMA DSP allows the system to virtually reproduce the sound field of the surround speakers with front left and right speakers. Even if the surround speakers are not connected, the unit creates the realistic sound field in a listening room.

Supported devices and file formats

Supported devices

USB devices

- This unit supports USB mass storage class devices (e.g., flash memories or portable audio players) using FAT16 or FAT32 format.
- Do not connect devices other than USB mass storage class devices (such as USB chargers or USB hubs), PCs, card readers, an external HDD, etc.
- USB devices with encryption cannot be used.
- Some features may not be compatible, depending on the model or manufacturer of the USB storage device.

iPod

Made for.

iPod touch (2nd, 3rd, 4th and 5th generation)
iPod classic
iPod nano (2nd, 3rd, 4th, 5th, 6th and 7th generation)
iPhone 5, iPhone 4S, iPhone 4, iPhone 3GS, iPhone 3G
(as of December 2013)

- An iPod may not be detected by the unit or some features may not be compatible, depending on the model or software version of the iPod.

File formats

USB

- The unit supports WAV (PCM format only), MP3, WMA and MPEG-4 AAC files (1- or 2-channel audio only).
- The unit is compatible with sampling rate of up to 48 kHz.
- Digital Rights Management (DRM) contents cannot be played back.

Video signal flow

Video signals input from a video device to the unit are output to a TV as shown below.

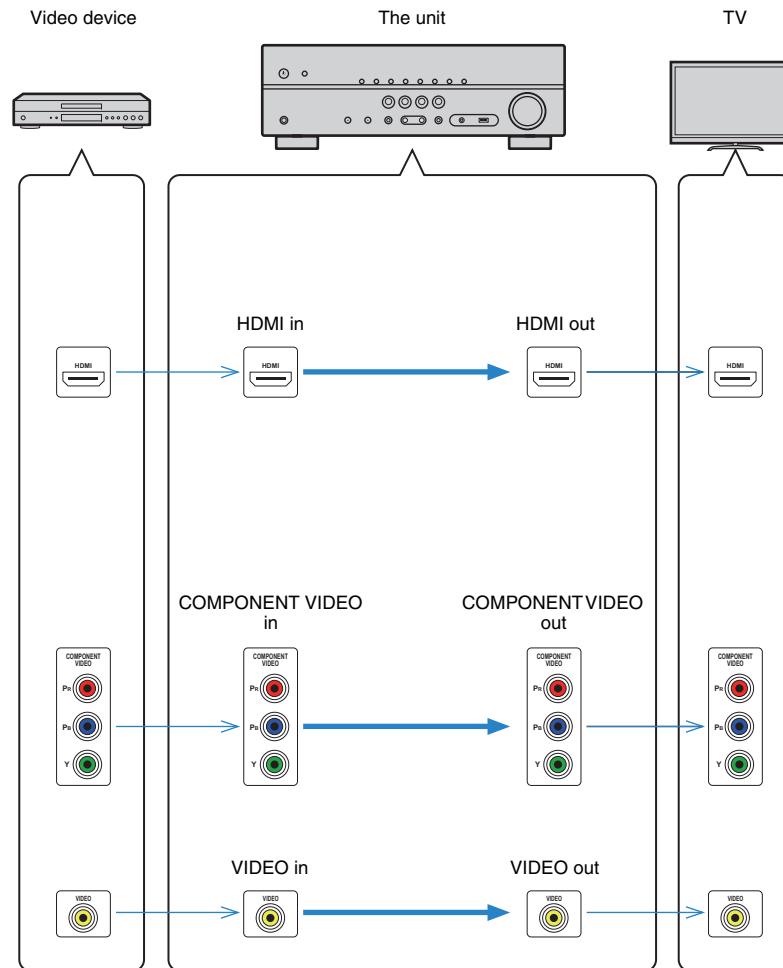

Information on HDMI

HDMI Control

HDMI Control allows you to operate external devices via HDMI. If you connect a TV that supports HDMI Control to the unit with an HDMI cable, you can control the unit (such as power and volume) with TV remote control operations. You can also control playback devices (such as HDMI Control-compatible BD/DVD players) connected to the unit with an HDMI cable.

Operations available from the TV's remote control

- Standby synchronization
- Volume control including mute
- Switching to input audio from the TV when the TV input is switched to its built-in tuner
- Switching to input video/audio from the selected playback device
- Switching between audio output devices (the unit or TV speaker)

(Example)

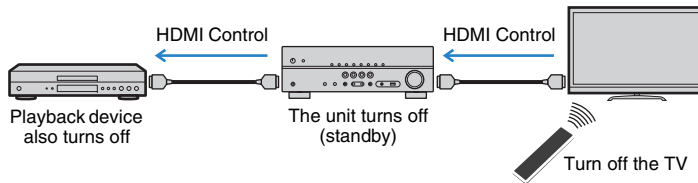

Operations available from the unit's remote control

- Starting playback on the playback device and turning on the TV with a scene selection (p.31)
- Switching the TV input to display the "Setup" menu (when SETUP is pressed)
- Controlling the playback device (playback and menu operations)

(Example)

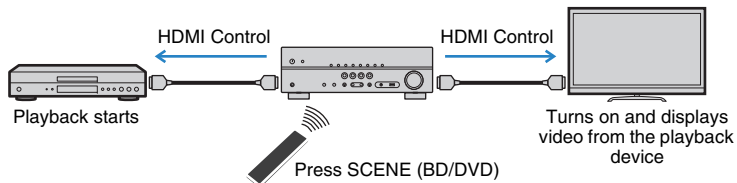

To use HDMI Control, you need to perform the following HDMI Control link setup after connecting the TV and playback devices.

For details on settings and operating your TV, refer to the instruction manual for the TV.



- This setup is required every time you add a new HDMI Control-compatible device to your system.

1 Turn on the unit, TV, and playback devices.

2 Configure the settings of the unit.

- ① Switch the TV input to display video from the unit.
- ② Press SETUP.

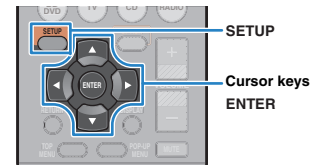

- ③ Use the cursor keys to select "HDMI" and press ENTER.

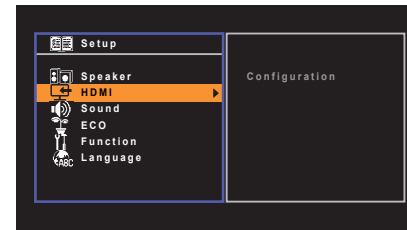

- ④ Press ENTER again.
- ⑤ Use the cursor keys (Δ/∇) to select "HDMI Control" and the cursor keys (\leftarrow/\rightarrow) to select "On" as shown below.

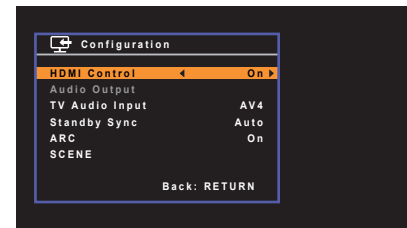

⑥ If you made a digital optical cable connection between the TV and the unit, use the cursor keys (△/▽) to select "TV Audio Input" and the cursor keys (◀/▶) to select "AV 1".

⑦ Press SETUP.

3 Enable HDMI Control on the TV and playback devices (such as HDMI Control-compatible BD/DVD players).

4 Turn off the main power of the TV and then turn off the unit and playback devices.

5 Turn on the unit and playback devices and then turn on the TV.

6 Switch the TV input to display the video from the unit.

7 Check the followings.

On the unit: The input to which the playback device is connected is selected. If not, select the input source manually.

On the TV: The video from the playback device is displayed.

8 Check that the unit is properly synchronized with the TV by turning off the TV or adjusting the TV volume with the TV remote control.



- If HDMI Control does not work properly, try unplugging the TV in Step 2 and plugging in the TV again in Step 3. It may solve the problem. Also, HDMI Control may not work if the number of connected devices exceeds the limit. In this case, disable HDMI Control on the devices not in use.
- If the unit is not synchronized to the TV's power operations, check the priority of the audio output setting on the TV.
- We recommend using TV and playback devices from the same manufacturer so that HDMI Control works more effectively.

Audio Return Channel (ARC)

ARC allows you to input TV audio to the unit with the HDMI cable which transmits video signal to the TV.

Check the following after the HDMI Control settings.

1 Select a TV program with the TV remote control.

2 Check that the input source of the unit will be automatically switched to "AV 4" and the TV audio will be played back on the unit.

If you cannot hear the TV audio, check the following:

- "ARC" (p.57) in the "Setup" menu is set to "On".
- The HDMI cable is connected to the ARC-compatible HDMI jack (HDMI jack marked "ARC") on the TV.

Some HDMI jack on the TV is not compatible with ARC. For details, refer to the instruction manual for the TV.



- If the audio is interrupted while using ARC, set "ARC" (p.57) in the "Setup" menu to "Off" and use a digital optical cable to input TV audio to the unit (p.18).
- When using ARC, connect a TV with an HDMI cable that supports ARC.



- "AV 4" is set as TV audio input at the factory. If you have connected any external device to the AV 4 jacks, use "TV Audio Input" (p.57) in the "Setup" menu to change the TV audio input assignment. To use the SCENE function (p.31), you also need to change the input assignment for SCENE (TV).

HDMI signal compatibility

Audio signals

| Audio signal type | Audio signal format | Compatible media (example) |
|--------------------------------------|--|--------------------------------------|
| 2ch Linear PCM | 2ch, 32 to 192 kHz, 16/20/24 bit | CD, DVD-Video, DVD-Audio |
| Multichannel Linear PCM | 8ch, 32 to 192 kHz, 16/20/24 bit | DVD-Audio, BD (Blu-ray disc), HD DVD |
| DSD | 2 to 5.1ch, 2.8224 MHz, 1 bit | SACD |
| Bitstream | Dolby Digital, DTS | DVD-Video |
| Bitstream (High definition audio) | Dolby TrueHD, Dolby Digital Plus, DTS-HD Master Audio, DTS-HD High Resolution Audio, DTS Express | BD (Blu-ray disc), HD DVD |

Video signals

The unit is compatible with the video signals of the following resolutions:

- 480i/60 Hz
- 576i/50 Hz
- 480p/60 Hz
- 576p/50 Hz
- 720p/60 Hz, 50 Hz
- 1080i/60 Hz, 50 Hz
- 1080p/60 Hz, 50 Hz, 24 Hz
- 4K/30 Hz, 25 Hz, 24 Hz



- When CPPM copy-protected DVD-Audio is played back, video/audio signals may not be output, depending on the type of the DVD player.
- The unit is not compatible with HDCP-incompatible HDMI or DVI devices. For details, refer to the instruction manual for each device.
- To decode audio bitstream signals on the unit, set the input source device appropriately so that the device outputs the bitstream audio signals directly (does not decode the bitstream signals on the playback device). For details, refer to the instruction manual for the playback device.

Reference diagram (rear panel)

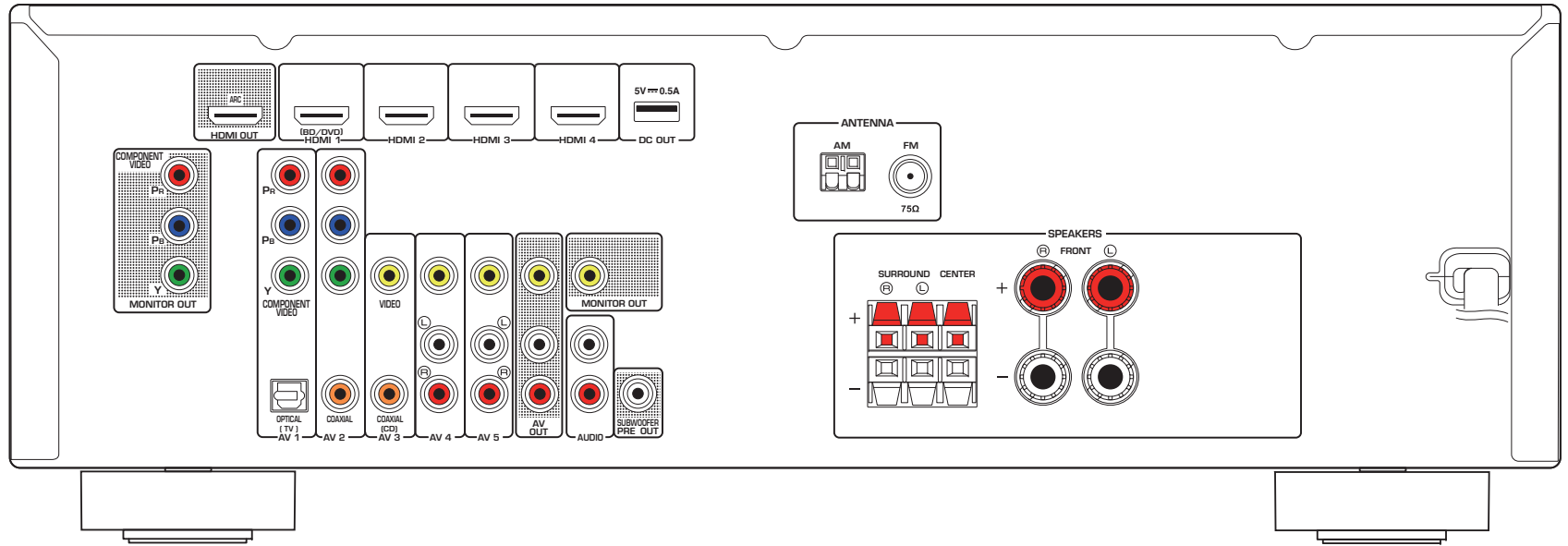

- The area around the video/audio output jacks is marked in white on the actual product to prevent improper connections.

Trademarks



Manufactured under license from Dolby Laboratories. Dolby, Pro Logic and the double-D symbol are trademarks of Dolby Laboratories.



Manufactured under license under U.S. Patent Nos: 5,956,674; 5,974,380; 6,226,616; 6,487,535; 7,212,872; 7,333,929; 7,392,195; 7,272,567 & other U.S. and worldwide patents issued & pending. DTS-HD, the Symbol, & DTS-HD and the Symbol together are registered trademarks of DTS, Inc. Product includes software. © DTS, Inc. All Rights Reserved.

Made for



"Made for iPod" and "Made for iPhone" mean that an electronic accessory has been designed to connect specifically to iPod or iPhone, respectively, and has been certified by the developer to meet Apple performance standards.

Apple is not responsible for the operation of this device or its compliance with safety and regulatory standards.

Please note that the use of this accessory with iPod or iPhone may affect wireless performance.

iPhone, iPod, iPod classic, iPod nano and iPod touch are trademarks of Apple Inc., registered in the U.S. and other countries.



HDMI, the HDMI Logo, and High-Definition Multimedia Interface are trademarks or registered trademarks of HDMI Licensing LLC in the United States and other countries.

x.v.Color™

"x.v.Color" is a trademark of Sony Corporation.



"SILENT CINEMA" is a trademark of Yamaha Corporation.

Specifications

Input jacks

- Analog Audio
Audio x 4 (AV 4–5, AUDIO, AUX [Mini Jack])
- Digital Audio (Supported frequencies: 32 kHz to 96 kHz)
Optical x 1 (AV 1)
Coaxial x 2 (AV 2–3)
- Video
Composite x 3 (AV 3–5)
Component x 2 (AV 1–2)
- HDMI Input
HDMI x 4 (HDMI 1–4)
- Other jacks
USB x 1 (USB2.0)

Output jacks

- Analog Audio
Speaker out x 5 (FRONT L/R, CENTER, SURROUND L/R)
Subwoofer out x 1 (SUBWOOFER PRE OUT)
AV OUT x 1
Headphone x 1 (PHONES)
- Video
Composite x 2 (MONITOR OUT, AV OUT)
Component x 1 (MONITOR OUT)

- HDMI Output
HDMI OUT x 1

Other jacks

- YPAO MIC x 1
- DC OUT x 1

HDMI

- HDMI Features: Deep Color, "x.v.Color," Auto Lip Sync, ARC (Audio Return Channel), 3D, 4K Ultra HD

- Video Format (Repeater Mode)
 - VGA
 - 480i/60 Hz
 - 576i/50 Hz
 - 480p/60 Hz
 - 576p/50 Hz
 - 720p/60 Hz, 50 Hz
 - 1080i/60 Hz, 50 Hz
 - 1080p/60 Hz, 50 Hz, 24 Hz
 - 4K/30 Hz, 25 Hz, 24 Hz
- Audio Format
 - Dolby TrueHD
 - Dolby Digital Plus
 - Dolby Digital
 - DTS-HD Master Audio
 - DTS-HD High Resolution Audio
 - DTS Express
 - DTS
 - DSD 2-ch to 6-ch
 - PCM 2-ch to 8-ch (Max. 192 kHz/24-bit)
- Content Protection: HDCP compatible
- Link Function: CEC supported

TUNER

- Analog Tuner
[U.K. and Europe models]
FM/AM with Radio Data System x 1 (TUNER)
[Other models]
FM/AM x 1 (TUNER)

USB

- Capable of iPod, Mass Storage Class USB Memory
- Current Supply Capacity: 1.0 A

Compatible Decoding Formats

- Decoding Format
 - Dolby TrueHD, Dolby Digital Plus
 - Dolby Digital
 - DTS-HD Master Audio, DTS-HD High Resolution Audio, DTS Express
 - DTS, DTS 96/24, DTS-ES Matrix 6.1, DTS-ES Discrete 6.1
- Post Decoding Format
 - Dolby Pro Logic
 - Dolby Pro Logic II Music, Dolby Pro Logic II Movie, Dolby Pro Logic II Game
 - DTS Neo:6 Music, DTS Neo:6 Cinema

Audio Section

- Rated Output Power (2-channel driven)
[U.S.A. and Canada models] (20 Hz to 20 kHz, 0.09% THD, 8 Ω)
[Other models] (20 Hz to 20 kHz, 0.09% THD, 6 Ω)
Front L/R..... 70 W+70 W
[U.S.A. and Canada models] (1 kHz, 0.9% THD, 8 Ω)
Front L/R..... 85 W+85 W
Center 85 W
Surround L/R..... 85 W+85 W
- Rated Output Power (1-channel driven)
[U.S.A. and Canada models] (1 kHz, 0.9% THD, 8 Ω)
[Other models] (1 kHz, 0.9% THD, 6 Ω)
Front L/R..... 100 W/ch
Center 100 W/ch
Surround L/R..... 100 W/ch
- Maximum Effective Output Power (1-channel driven)
(JEITA, 1 kHz, 10% THD, 6 Ω)
[Korea, Asia, Taiwan and General models]
Front L/R..... 135 W/ch
Center 135 W/ch
Surround L/R..... 135 W/ch

- Dynamic Power (1-channel driven) (IHF)
[U.S.A. and Canada models]
Front L/R (8/6/4/2 Ω) 110/130/160/180 W
[Other models]
Front L/R (6/4/2 Ω) 110/130/150 W
- Damping Factor
Front L/R, 20 Hz to 20 kHz, 8 Ω 120 or more
- Input Sensitivity / Input Impedance
AV 4 etc. (1 kHz, 100 W/6 Ω) 200 mV/47 kΩ
- Maximum Input Signal
AV 4 etc. (1 kHz, 0.5% THD, Effect On) 2.3 V
- Output Level / Output Impedance
AV OUT 200 mV/1.2 kΩ
SUBWOOFER 1 V/1.2 kΩ
- Headphone Jack Rated Output / Impedance
AV 4 etc. (1 kHz, 50 mV, 8 Ω) 100 mV/470 Ω
- Frequency Response
AV 4 etc. to Front (10 Hz to 100 kHz) +0/-3 dB
- Signal to Noise Ratio (IHF-A Network)
AV 4 etc. (Input 1 kΩ Shorted, Speaker Out)
..... 110 dB or more
- Residual Noise (IHF-A Network)
Front L/R (Speaker Out) 150 μV or less
- Channel Separation
AV 4 etc. (Input 1 kΩ Shorted, 1 kHz/10 kHz)
..... 70 dB/50 dB or more
- Volume Control
Range MUTE, -80 dB to +16.5 dB
Step 0.5 dB
- Tone Control Characteristics (Front L/R)
Bass Boost/Cut ±6 dB/0.5 dB Step at 50 Hz
Bass Turnover 350 Hz
Treble Boost/Cut ±6 dB/0.5 dB Step at 20 kHz
Treble Turnover 3.5 kHz

- Filter Characteristics
(fc=40/60/80/90/100/110/120/160/200 Hz)
H.P.F. (Front, Center, Surround) 12 dB/oct.
L.P.F. (Subwoofer) 24 dB/oct.

Video Section

- Video Signal Type
[U.S.A., Canada, Korea, Taiwan and General models]... NTSC
[Other models] PAL
- Video Signal Level
Composite 1 Vp-p/75 Ω
Component
Y 1 Vp-p/75 Ω
Pb/Pr 0.7 Vp-p/75 Ω
- Video Maximum Input Level (Video Conversion Off)
..... 1.5 Vp-p or more
- Video Signal to Noise Ratio 50 dB or more
- Monitor Out Frequency Response (Video Conversion Off)
Component 5 Hz to 60 MHz, -3 dB

FM Section

- Tuning Range
[U.S.A. and Canada models] 87.5 MHz to 107.9 MHz
[Asia, Taiwan and General models]
..... 87.5/87.50 MHz to 108.0/108.00 MHz
[Other models] 87.50 MHz to 108.00 MHz
- 50 dB Quiet Sensitivity (IHF, 1 kHz, 100% MOD.)
Mono 2 μV (17.3 dBf)
- Signal to Noise Ratio (IHF)
Mono 71 dB
Stereo 70 dB
- Harmonic Distortion (IHF, 1 kHz)
Mono 0.5%
Stereo 0.6%
- Antenna Input 75 Ω unbalanced

AM section

- Tuning Range
[U.S.A. and Canada models] 530 kHz to 1710 kHz
[Asia, Taiwan and General models]
..... 530/531 kHz to 1710/1611 kHz
[Other models] 531 kHz to 1611 kHz

General

- Power Supply
[U.S.A. and Canada models] AC 120 V, 60 Hz
[Taiwan and General models]
..... AC 110 to 120/220 to 240 V, 50/60 Hz
[Korea model] AC 220 V, 60 Hz
[Australia model] AC 240 V, 50 Hz
[U.K. and Europe models] AC 230 V, 50 Hz
[Asia model] AC 220 to 240 V, 50/60 Hz
- Power Consumption
[U.S.A. and Canada models] 260 W
[Other models] 260 W
- Standby Power Consumption
HDMI Control Off
[Taiwan and General models] 0.5 W or less
[Other models] 0.3 W or less
HDMI Control On (No Signals) 0.8 W (Typical)
- Maximum Power Consumption
[Taiwan and General models] 470 W
- Dimensions (W x H x D)
..... 435 x 151 x 315 mm (17-1/8" x 6" x 12-3/8")
* Including legs and protrusions
- Weight 7.4 kg (16.3 lbs)

* Specifications are subject to change without notice.

Index

Symbols

Lock icon (🔒) 62

Numerics

2.1-channel system 14
2ch Stereo (sound program) 34
3.1-channel system 13
4.1-channel system 13
4K Ultra HD 78
5.1-channel system 13, 15
5.1-channel system (Virtual CINEMA FRONT) 13
5ch Stereo (sound program) 34

A

A.DRC (DSP/Surround, Option menu) 49
Access error (error indication) 72
Action Game (sound program) 33
Adaptive DRC (DSP/Surround, Option menu) 49
Adjustment (Lipsync, Setup menu) 59
ADVANCED SETUP menu 64
Adventure (sound program) 33
AM radio listening 37
Amp (Audio Output, Setup menu) 57
ARC (Audio Return Channel) 77
ARC (HDMI, Setup menu) 57
Audio Decoder (front display information) 30
Audio file format (USB storage device) 75
Audio In (Option menu) 50
Audio Output (HDMI, Setup menu) 57
Audio Return Channel (ARC) 77
Auto Power Standby (ECO, Setup menu) 61
Auto Preset (FM radio, Option menu) 38
Automatic speaker setting optimization 26
Automatic station preset (FM radio) 38
AutoPowerStdby (ECO, Setup menu) 61

B

B RATE (Signal Info, Option menu) 50

Banana plug 15
Basic playback operation 30
BASS (sound mode) 36
Bass (Tone Control, Option menu) 49
Bitrate (Signal Info, Option menu) 50
Bitstream 78

C

Cellar Club (sound program) 34
Center (Speaker, Setup menu) 54
Center Image (DSP Parameter, Setup menu) 59
Center Width (DSP Parameter, Setup menu) 59
Chamber (sound program) 34
CHAN (Signal Info, Option menu) 50
Channel (Signal Info, Option menu) 50
Check SP Wires (error indication) 72
CINEMA DSP 33
Clear Preset (FM/AM radio, Option menu) 39
Clock Time (Radio Data System) 40
Compressed Music Enhancer 36
Configuration (HDMI, Setup menu) 57
Configuration (Speaker, Setup menu) 54
Connect error (error indication) 72
Crossover (Speaker, Setup Menu) 54
Crossover frequency setting (subwoofer) 26, 54

D

Decoder Off (front display information) 30
Default setting restoration 65
Dimension (DSP Parameter, Setup menu) 59
Dimmer (Function, Setup menu) 62
Direct Stream Digital (DSD) 73
Distance (Speaker, Setup menu) 55
Dolby Pro Logic (surround decoder) 35
Dolby Pro Logic II (surround decoder) 35
Drama (sound program) 33
DSD (Direct Stream Digital) 73
DSP Level (DSP/Surround, Option menu) 49

DSP Parameter (Sound, Setup menu) 59
DSP Program (front display information) 30
DSP/Surround (Option menu) 49
DTS Neo:6 (surround decoder) 35
Dynamic Range (Volume, Setup menu) 60

E

ECO (Setup menu) 61
ECO Mode (ECO, Setup menu) 61
Enhancer (DSP/Surround, Option menu) 49
ENHANCER (sound mode) 36
EQ Select (Equalizer, Setup menu) 55
Equalizer (Speaker, Setup menu) 55
Error indication (front display) 72
Extra Bass (Speaker, Setup menu) 55

F

Firmware update 66
Firmware version check 66
FM radio listening 37
FM/AM radio tuning 37
FORMAT (Signal Info, Option menu) 50
Format (Signal Info, Option menu) 50
Frequency (FM/AM radio) 37
Frequency step setting 37, 65
Front (Speaker, Setup menu) 54
Front display (part names and functions) 8
Front display brightness 62
Front display information 30
Front panel (part names and functions) 7
Function (Setup menu) 62

G

GEQ (Equalizer, Setup menu) 55

H

Hall in Munich (sound program) 34
Hall in Vienna (sound program) 34
HDMI (Setup menu) 57

HDMI Control (HDMI, Setup menu) 57
HDMI OUT (TV) (Audio Output, Setup menu) 57
HDMI signal compatibility 78
Headphones 34
High definition audio 78

I

In.Trim (Volume Trim, Option menu) 49
Indicator (part names and functions) 8
Information display (front display) 8
Information switching (front display) 30
INIT (ADVANCED SETUP menu) 65
Initial Volume (Volume, Setup menu) 60
Input (front display information) 30
Input Rename (Function, Setup menu) 62
Input Trim (Volume Trim, Option menu) 49
Internal Err. (YPAO error message) 28
Internal Error (error indication) 72
iPod charge 41
iPod content playback 41

L

Language (Setup menu) 63
Level (Speaker, Setup menu) 55
Level Error (YPAO warning message) 29
LFE (Low Frequency Effects) 74
Lipsync 74
Lipsync (Option menu) 50
Lipsync (Sound, Setup menu) 59
Low Frequency Effects (LFE) 74

M

Manual station preset (FM/AM radio) 38
Max Volume (Volume, Setup menu) 60
Memory Guard (Function, Setup menu) 62
Menu language selection 25
Monaural reception (FM radio) 37
Mono Movie (sound program) 33
MOVIE (sound program category) 33
MUSIC (sound program category) 34
Music Video (sound program) 34

Muting 30

N

No content (error indication) 72
No Front SP (YPAO error message) 28
No MIC (YPAO error message) 28
No Signal (YPAO error message) 28
No Sur. SP (YPAO error message) 28
Noisy (YPAO error message) 28
NTSC (TV FORMAT, ADVANCED SETUP menu) 65

O

Option menu 48
Out of Phase (YPAO warning message) 29
Over Distance (YPAO warning message) 29

P

PAL (TV FORMAT, ADVANCED SETUP menu) 65
Panorama (DSP Parameter, Setup menu) 59
PEQ (Equalizer, Setup menu) 55
Power management 61
Preset station selection (FM/AM radio) 39
Program Service (Radio Data System) 40
Program Type (Radio Data System) 40

R

Radio Data System information 40
Radio Data System tuning 40
Radio Text (Radio Data System) 40
Random (USB storage device, Option menu) 47
Rear panel (part names and functions) 9
RemID Mismatch (error indication) 72
Remote control (part names and functions) 10
Remote control ID setting 65
REMOTE ID (ADVANCED SETUP menu) 65
Rename (input name) 62
Repeat (iPod, Option menu) 44
Repeat (USB storage device, Option menu) 47
Roleplaying Game (sound program) 33

S

SAMPL (Signal Info, Option menu) 50

Sampling (Signal Info, Option menu) 50
Scale (Volume, Setup menu) 60
SCENE (HDMI, Setup menu) 58
Scene configuration 31
SCENE function 31
SCENE link playback 31
Sci-Fi (sound program) 33
Select (Lipsync, Setup menu) 59
Setup menu 51
Shuffle (iPod, Option menu) 44
Signal Info (Option menu) 50
Signal information 50
SILENT CINEMA 34
Simple play (iPod) 43
Sleep timer 10
Sound (Setup menu) 59
Sound field effect 33
Sound mode selection 32
Sound program 33
SP IMP. (ADVANCED SETUP menu) 64
Speaker (Setup menu) 54
Speaker impedance 12
Speaker impedance setting 14, 64
Speaker placement 12
Spectacle (sound program) 33
Sports (sound program) 33
Standard (sound program) 33
Standby Sync (HDMI, Setup menu) 57
Station preset (FM/AM radio) 38
Stereo reception (FM radio) 37
STRAIGHT (sound mode) 35
Straight decode 35
Subwoofer (Speaker, Setup menu) 54
Subwoofer Phase (Speaker, Setup menu) 55
Subwoofer Trim (Volume Trim, Option menu) 49
SUR.DECODE (sound mode) 35
Surround (Speaker, Setup menu) 54
Surround decoder 35
SW.Trim (Volume Trim, Option menu) 49

T

- Test Tone (Speaker, Setup menu) 56
- The Bottom Line (sound program) 34
- The Roxy Theatre (sound program) 34
- Tone Control (Option menu) 49
- TP (Traffic Program) 40
- Traffic information (Radio Data System) 40
- Traffic Program (FM radio, Option menu) 40
- Treble (Tone Control, Option menu) 49
- TU (ADVANCED SETUP menu) 65
- TV Audio Input (HDMI, Setup menu) 57
- TV FORMAT (ADVANCED SETUP menu) 65

U

- Unable to play (error indication) 72
- Unknown iPod (error indication) 72
- UPDATE (ADVANCED SETUP menu) 66
- USB storage device content playback 45
- User Cancel (YPAO error message) 28

V

- V IN (Signal Info, Option menu) 50
- V OUT (Signal Info, Option menu) 50
- VERSION (ADVANCED SETUP menu) 66
- Video In (Signal Info, Option menu) 50
- Video Out (Option menu) 50
- Video Out (Signal Info, Option menu) 50
- Video signal flow 75
- Video signal type setting 65
- Video/audio input jack combination 21
- Virtual CINEMA DSP 34
- Virtual CINEMA FRONT 34
- Virtual CINEMA FRONT (Speaker, Setup menu) 55
- Voltage selection 24
- Volume (Sound, Setup menu) 60
- Volume Trim (Option menu) 49

Y

- Yamaha Parametric room Acoustic Optimizer (YPAO) 26

YPAO

- (Yamaha Parametric room Acoustic Optimizer) 26
- YPAO error message 28
- YPAO microphone 26
- YPAO warning message 29



YAMAHA CORPORATION

© 2014 Yamaha Corporation YG025A0/EN