





UA

Front Surround System
(CENTER SYSTEM + SUBWOOFER/SYSTEM CONTROL)

YAS-71/YAS-81
*(YAS-71CU + YAS-71SPX/
YAS-81CU + YAS-81SPX)*

OWNER'S MANUAL

IMPORTANT SAFETY INSTRUCTIONS

	CAUTION RISK OF ELECTRIC SHOCK DO NOT OPEN	
CAUTION: TO REDUCE THE RISK OF ELECTRIC SHOCK, DO NOT REMOVE COVER (OR BACK). NO USER-SERVICEABLE PARTS INSIDE. REFER SERVICING TO QUALIFIED SERVICE PERSONNEL.		

- **Explanation of Graphical Symbols**

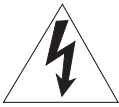

The lightning flash with arrowhead symbol, within an equilateral triangle, is intended to alert you to the presence of uninsulated "dangerous voltage" within the product's enclosure that may be of sufficient magnitude to constitute a risk of electric shock to persons.



The exclamation point within an equilateral triangle is intended to alert you to the presence of important operating and maintenance (servicing) instructions in the literature accompanying the appliance.

Note to CATV system installer:

This reminder is provided to call the CATV system installer's attention to Article 820-40 of the NEC that provides guidelines for proper grounding and, in particular, specifies that the cable ground shall be connected to the grounding system of the building, as close to the point of cable entry as practical.

IMPORTANT

Please record the serial number of this unit in the space below.

MODEL:

Serial No.:

The serial number is located on the rear of the unit.

Retain this Owner's Manual in a safe place for future reference.

- 1 Read these instructions.
- 2 Keep these instructions.
- 3 Heed all warnings.
- 4 Follow all instructions.
- 5 Do not use this apparatus near water.
- 6 Clean only with dry cloth.
- 7 Do not block any ventilation openings. Install in accordance with the manufacturer's instructions.
- 8 Do not install near any heat sources such as radiators, heat registers, stoves, or other apparatus (including amplifiers) that produce heat.
- 9 Do not defeat the safety purpose of the polarized or grounding-type plug. A polarized plug has two blades with one wider than the other. A grounding type plug has two blades and a third grounding prong. The wide blade or the third prong are provided for your safety. If the provided plug does not fit into your outlet, consult an electrician for replacement of the obsolete outlet.
- 10 Protect the power cable from being walked on or pinched particularly at plugs, convenience receptacles, and the point where they exit from the apparatus.
- 11 Only use attachments/accessories specified by the manufacturer.
- 12 Use only with the cart, stand, tripod, bracket, or table specified by the manufacturer, or sold with the apparatus. When a cart is used, use caution when moving the cart/apparatus combination to avoid injury from tip-over.
- 13 Unplug this apparatus during lightning storms or when unused for long periods of time.
- 14 Refer all servicing to qualified service personnel. Servicing is required when the apparatus has been damaged in any way, such as power-supply cable or plug is damaged, liquid has been spilled or objects have fallen into the apparatus, the apparatus has been exposed to rain or moisture, does not operate normally, or has been dropped.



FCC INFORMATION (for US customers)

1 IMPORTANT NOTICE: DO NOT MODIFY THIS UNIT!

This product, when installed as indicated in the instructions contained in this manual, meets FCC requirements. Modifications not expressly approved by Yamaha may void your authority, granted by the FCC, to use the product.

2 IMPORTANT: When connecting this product to accessories and/or another product use only high quality shielded cables. Cable/s supplied with this product **MUST** be used. Follow all installation instructions. Failure to follow instructions could void your FCC authorization to use this product in the USA.

3 NOTE: This product has been tested and found to comply with the requirements listed in FCC Regulations, Part 15 for Class "B" digital devices. Compliance with these requirements provides a reasonable level of assurance that your use of this product in a residential environment will not result in harmful interference with other electronic devices.

This equipment generates/uses radio frequencies and, if not installed and used according to the instructions found in the users manual, may cause interference harmful to the operation of other electronic devices.

Compliance with FCC regulations does not guarantee that interference will not occur in all installations. If this product is found to be the source of interference, which can be determined by turning the unit "OFF" and "ON", please try to eliminate the problem by using one of the following measures:

Relocate either this product or the device that is being affected by the interference.

Utilize power outlets that are on different branch (circuit breaker or fuse) circuits or install AC line filter/s.

In the case of radio or TV interference, relocate/reorient the antenna. If the antenna lead-in is 300 ohm ribbon lead, change the lead-in to coaxial type cable.

If these corrective measures do not produce satisfactory results, please contact the local retailer authorized to distribute this type of product. If you can not locate the appropriate retailer, please contact Yamaha Electronics Corp., U.S.A. 6660 Orangethorpe Ave., Buena Park, CA 90620.

The above statements apply **ONLY** to those products distributed by Yamaha Corporation of America or its subsidiaries.

Caution: Read this before operating your unit.

- 1 To assure the finest performance, please read this manual carefully. Keep it in a safe place for future reference.
- 2 Install this sound system in a well ventilated, cool, dry, clean place – away from direct sunlight, heat sources, vibration, dust, moisture, and/or cold. Allow ventilation space of at least 5 cm (2”) on the top, left, right, and the back of this unit.
- 3 Locate this unit away from other electrical appliances, motors, or transformers to avoid humming sounds.
- 4 Do not expose this unit to sudden temperature changes from cold to hot, and do not locate this unit in an environment with high humidity (i.e. a room with a humidifier) to prevent condensation inside this unit, which may cause an electrical shock, fire, damage to this unit, and/or personal injury.
- 5 Avoid installing this unit where foreign objects may fall onto this unit and/or this unit may be exposed to liquid dripping or splashing. On the top of this unit, do not place:
 - Other components, as they may cause damage and/or discoloration on the surface of this unit.
 - Burning objects (i.e. candles), as they may cause fire, damage to this unit, and/or personal injury.
 - Containers with liquid in them, as they may fall and liquid may cause electrical shock to the user and/or damage to this unit.
- 6 Do not cover this unit with a newspaper, tablecloth, curtain, etc. in order not to obstruct heat radiation. If the temperature inside this unit rises, it may cause fire, damage to this unit, and/or personal injury.
- 7 Do not plug in this unit to a wall outlet until all connections are complete.
- 8 Do not operate this unit upside-down. It may overheat, possibly causing damage.
- 9 Do not use force on switches, knobs and/or cords.
- 10 When disconnecting the power cable from the wall outlet, grasp the plug; do not pull the cable.
- 11 Do not clean this unit with chemical solvents; this might damage the finish. Use a clean, dry cloth.
- 12 Only voltage specified on this unit must be used. Using this unit with a higher voltage than specified is dangerous and may cause fire, damage to this unit, and/or personal injury. Yamaha will not be held responsible for any damage resulting from use of this unit with a voltage other than specified.
- 13 To prevent damage by lightning, keep the power cable and outdoor antennas disconnected from a wall outlet or the unit during a lightning storm.
- 14 Do not attempt to modify or fix this unit. Contact qualified Yamaha service personnel when any service is needed. The cabinet should never be opened for any reasons.
- 15 When not planning to use this unit for long periods of time (i.e. vacation), disconnect the AC power plug from the wall outlet.
- 16 Install this unit near the wall outlet and where the AC power plug can be reached easily.
- 17 Be sure to read the “Troubleshooting” section on common operating errors before concluding that this unit is faulty.
- 18 Before moving this unit, press **STANDBY/ON** to set this unit in standby mode, and disconnect the power supply cable from the wall outlet.
- 19 The batteries shall not be exposed to excessive heat such as sunshine, fire or like.
- 20 Condensation will form when the surrounding temperature changes suddenly. Disconnect the power supply cable from the outlet, then leave the unit alone.
- 21 Secure placement or installation is the owner’s responsibility. Yamaha shall not be liable for any accident caused by improper placement or installation of speakers.
- 22 This unit is not evaluated for wall mounting by CSA.

WARNING

TO REDUCE THE RISK OF FIRE OR ELECTRIC SHOCK, DO NOT EXPOSE THIS UNIT TO RAIN OR MOISTURE.

As long as this unit is connected to the AC wall outlet, it is not disconnected from the AC power source even if you turn off this unit by **STANDBY/ON**. In this state, this unit is designed to consume a very small quantity of power.

We Want You Listening For A Lifetime



Yamaha and the Electronic Industries Association’s Consumer Electronics Group want you to get the most out of your equipment by playing it at a safe level. One that lets the sound come through loud and clear without annoying blaring or distortion – and, most importantly, without affecting your sensitive hearing. Since hearing damage from loud sounds is often undetectable until it is too late, Yamaha and the Electronic Industries Association’s Consumer Electronics Group recommend you to avoid prolonged exposure from excessive volume levels.

CONTENTS

INTRODUCTION

GETTING STARTED.....	2
Supplied parts	2
Controls and functions.....	3

PREPARATION

PLACING THIS SYSTEM.....	8
Placing the center system.....	8
CONNECTION.....	11
Connecting the center system and the subwoofer/system control.....	11
Connecting external components.....	12
Connecting the Yamaha iPod universal dock.....	14
Connecting the Yamaha Bluetooth wireless audio receiver	14
Connecting the indoor FM antenna	14
Connecting the power cable.....	15

BASIC OPERATION

BASIC PLAYBACK OPERATION	16
AIR SURROUND XTREME.....	17
What is AIR SURROUND XTREME ?.....	17
Listening to surround mode of AIR SURROUND XTREME.....	18
Shifting the optimum listening area from side to side	19
Selecting the optimum listening area.....	20
Checking the virtual surround effect	20
Using extended stereo mode.....	21
Setting compressed music enhancer	21

OTHER FUNCTIONS

LISTENING TO FM BROADCASTS	22
Overview	22
Controls and functions for the FM tuning	22
Basic tuning operation	23
Using station preset feature	24
USING OPTIONAL EQUIPMENT	27
Using iPod™	27
Using Bluetooth™ components.....	29

USEFUL OPERATION

ADJUSTING THE AUDIO DELAY	31
LISTENING AT LOW VOLUME (NIGHT LISTENING MODE).....	32
ADJUSTING THE VOLUME BALANCE DURING PLAYBACK	32
CHANGING THE BRIGHTNESS OF THE FRONT PANEL DISPLAY.....	33

ADDITIONAL INFORMATION

ADDITIONAL INFORMATION	34
Troubleshooting.....	34
Glossary	37
Specifications.....	38

■ Introduction

YAS-71/YAS-81 consists of a center system (YAS-71CU/YAS-81CU) and subwoofer/system control (YAS-71SPX/YAS-81SPX). This product provides excellent sound with simple operations, allowing you to enjoy various audio sources. We hope the “YAS-71/YAS-81” brings you great listening pleasure and satisfaction.

■ About this manual

- In this manual, operations that can be performed using either the front panel buttons or remote control are explained using the remote control.
-  indicates a tip for your operation. Notes contain important information about safety and operating instructions.
- This manual is printed prior to production. Design and specifications are subject to change in part as a result of improvements, etc. In case of differences between the manual and the product, the product has priority.

GETTING STARTED

Supplied parts

This product consists of the following items. Before making connections, make sure you received all of the following items.

■ Units

Center system (YAS-71CU/YAS-81CU)

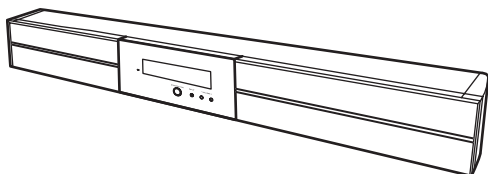

Subwoofer/system control (YAS-71SPX/YAS-81SPX)

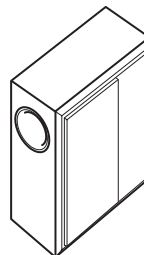

■ Accessories

System control cable (4 m)



Speaker cable (4 m)
(For US customers only)



Speaker cable (4 m)
(For Australian customers only)



Remote control

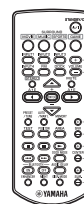

Indoor FM antenna

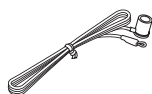

Spacer x 2

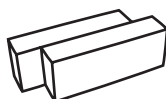

Battery x 2
(AAA, R03, UM4)

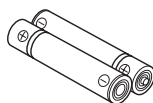

Mounting template



Double-sided tape (2 pieces)
Non-skid pad (2 pieces)
Screw x 6

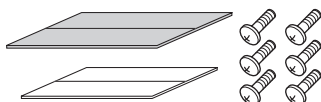

Cover



Owner's manual



- All the supplied parts for YAS-81 are included in the box of YAS-81SPX.

Controls and functions

■ Front panel of the center system

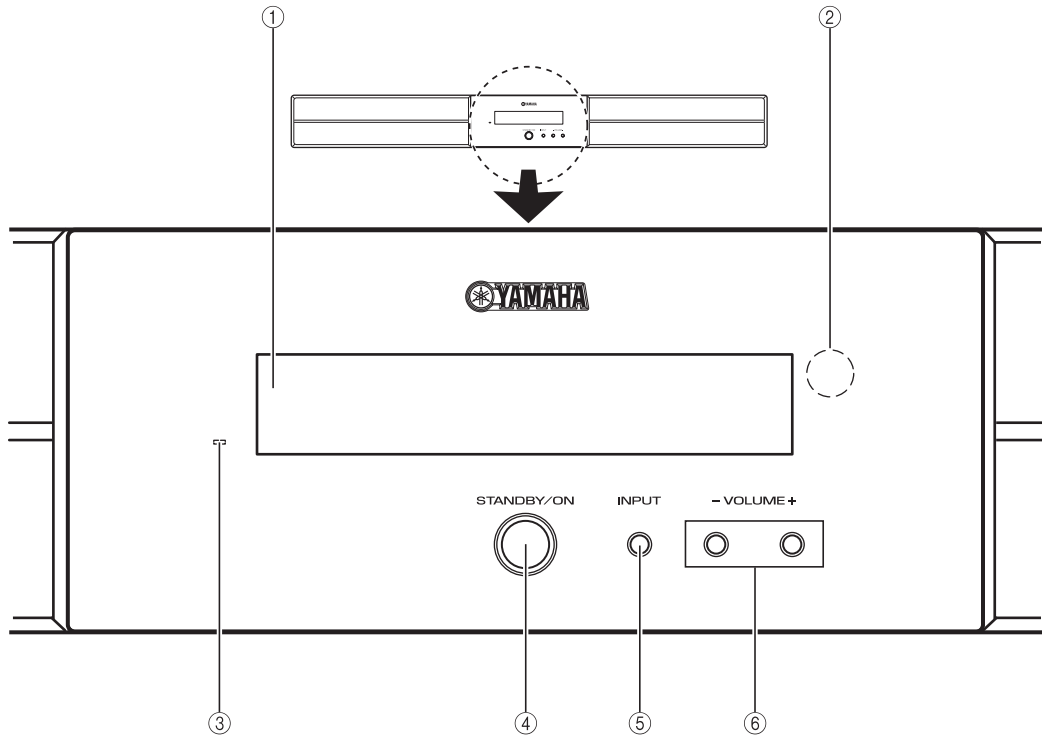

① **Front panel display**

Shows information about the operational status of the system. (☞ P. 4)

② **Remote control sensor**

Receives infrared signals from the remote control. (☞ P. 5, 7)

③ **Power indicator**

Lights up when the system is turned on. (☞ P. 16)

④ **STANDBY/ON**

Turns on the system, or sets it to standby mode. (☞ P. 16)

Note

A small amount of electricity is consumed to receive the infrared signal from the remote control even when the system is in standby mode.

⑤ **INPUT**

Selects an input source you want to listen to. (☞ P. 16)

⑥ **VOLUME +/-**

Controls the volume of the system. (☞ P. 16)

■ Front panel display of the center system

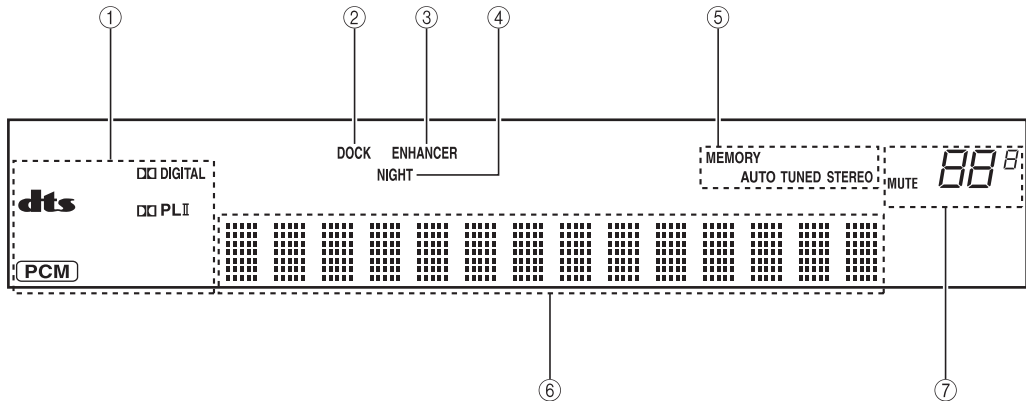

① Decoder indicators

The respective indicator lights up when any of the decoders of the system is functioning.

② DOCK indicator

- Lights up when the system is receiving a signal from an iPod stationed in the Yamaha iPod universal dock (such as YDS-10 or YDS-11, sold separately) connected to the DOCK terminal of the subwoofer/system control. (☞ P. 27)
- Lights up while the Yamaha Bluetooth wireless audio receiver (such as YBA-10, sold separately) is connected to the Bluetooth component. (☞ P. 29)
- Flashes while the connected Yamaha Bluetooth wireless audio receiver (such as YBA-10, sold separately) and the Bluetooth component are pairing or while the Yamaha Bluetooth wireless audio receiver is searching for the Bluetooth component. (☞ P. 29)

③ ENHANCER indicator

Lights up when compressed music enhancer mode is selected. (☞ P. 21)

④ NIGHT indicator

Lights up when you select night listening mode. (☞ P. 32)

⑤ Tuner indicators (AUTO/TUNED/STEREO/MEMORY)

AUTO indicator

Lights up when the system is in automatic tuning mode. (☞ P. 23)

TUNED indicator

Lights up when the system is receiving a station. (☞ P. 23)

STEREO indicator

Lights up when the system is receiving a strong signal from an FM stereo broadcast in automatic tuning mode. (☞ P. 23)

MEMORY indicator

Flashes to show a station can be stored. (☞ P. 24, 25)

⑥ Multi information display

Shows the selected input source, current surround mode and other information.

⑦ MUTE indicator/VOLUME indicator

- Flashes while the mute function is activated. (☞ P. 16)
- Indicates the current volume level.

Remote control

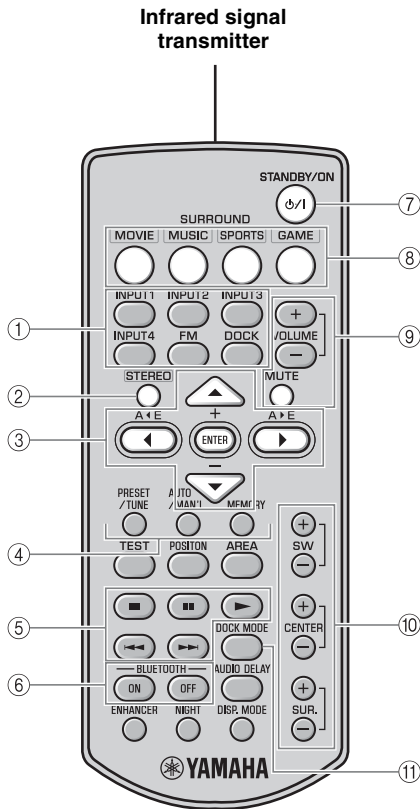

- ① **Input buttons**
Select an input source you want to listen to. (☞ P. 16)
- ② **STEREO**
 - Turns extended stereo mode on and off alternately. (☞ P. 21)
 - Turns off surround mode. (☞ P. 18)
- ③ **Cursors (◀/▶/▲/▼)/ENTER**
Position: Change the setting. (☞ P. 19)
Audio delay: Change the setting. (☞ P. 31)
iPod: Move the cursor. (☞ P. 27)
FM: Move a preset group and number forward or backward. (☞ P. 22)
- ④ **PRESET/TUNE, AUTO/MAN'L, MEMORY**
Control an FM tuner. (☞ P. 22)
- ⑤ **□ / ■ / ▷ / ◀◀ / ▶▶**
Control an iPod or a Bluetooth component. (☞ P. 27, 29)
- ⑥ **BLUETOOTH ON/BLUETOOTH OFF**
Connects or disconnects a Bluetooth component. (☞ P. 30)
- ⑦ **STANDBY/ON**
Turns on the system, or sets it to standby mode. (☞ P. 16)
- ⑧ **MOVIE/MUSIC/SPORTS/GAME**
Select surround mode. (☞ P. 18)
- ⑨ **VOLUME (+-)/MUTE**
Control the volume of the system. (☞ P. 16)
- ⑩ **SW (+-)/CENTER (+-)/SUR. (+-)**
Adjust the volume balance. (☞ P. 32)
- ⑪ **DOCK MODE**
Switches operation mode of the iPod. (☞ P. 27)

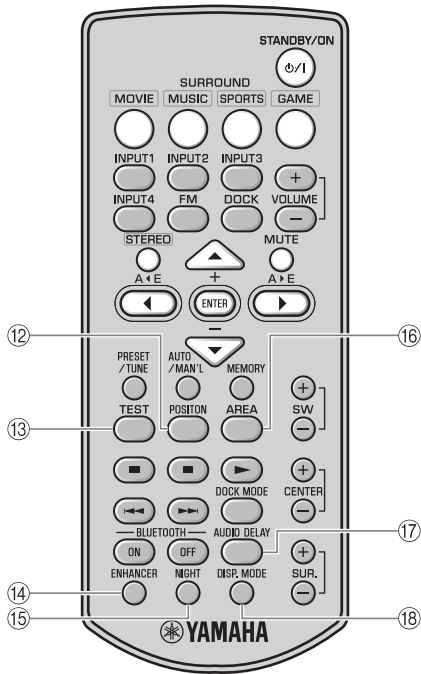

- ⑫ **POSITION**
Shifts the optimum listening area according to your listening position. (☞ P. 19)
- ⑬ **TEST**
Outputs the test tone. (☞ P. 20)
- ⑭ **ENHANCER**
Turns on and off compressed music enhancer mode alternately. (☞ P. 21)
- ⑮ **NIGHT**
Turns night listening mode on or off. (☞ P. 32)
- ⑯ **AREA**
Selects the optimum listening area. (☞ P. 20)
- ⑰ **AUDIO DELAY**
Delays the output sound to synchronize it with the video image. (☞ P. 31)
- ⑱ **DISP. MODE**
Changes the brightness of the front panel display. (☞ P. 33)

■ Using the remote control

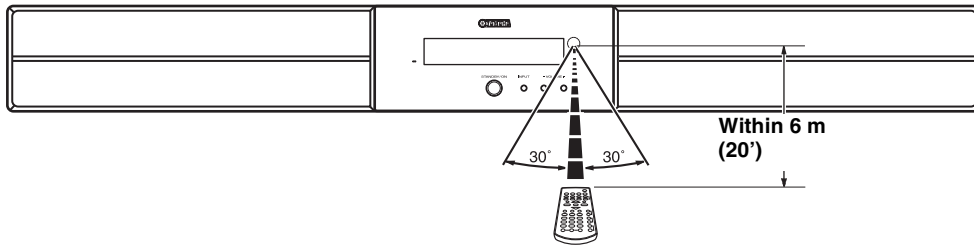

Use the remote control within 6 m (20') of the center system and point it toward the remote control sensor.

Notes

- Be careful not to spill liquid on the remote control.
- Be careful not to drop the remote control.
- Do not leave the remote control in a place that is:
 - hot or humid, such as near a heater or in a bathroom
 - extremely cold
 - dusty

■ Installing the batteries

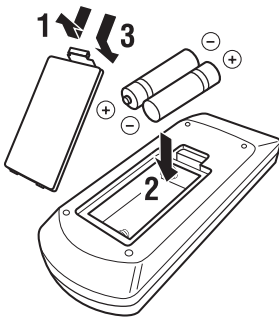

- 1** Take off the battery compartment cover.
- 2** Insert the 2 supplied batteries (AAA, R03, UM4), observing the polarity markings (+ and -) on the inside of the battery compartment.
- 3** Snap the battery compartment cover back into place.

Notes

- If the effective operation distance of the remote control decreases considerably, replace the batteries with two new ones as soon as possible.
- Do not use an old battery together with new one.
- Do not use different types of batteries (for example, alkaline and manganese) together. Their performance will vary, even if they are similar in shape.
- If the batteries run out, immediately remove them from the remote control to prevent an explosion or acid leak.
- Dispose of batteries according to regional regulations.
- If a battery starts leaking, dispose of it immediately. Be careful not to let leaking battery acid come into contact with your skin or clothing. Before inserting new batteries, wipe the compartment clean.

PLACING THIS SYSTEM

To enjoy quality sound thoroughly, you need to place this system in the appropriate positions, and install the components correctly. After deciding the layout, follow the procedure below to install this system.

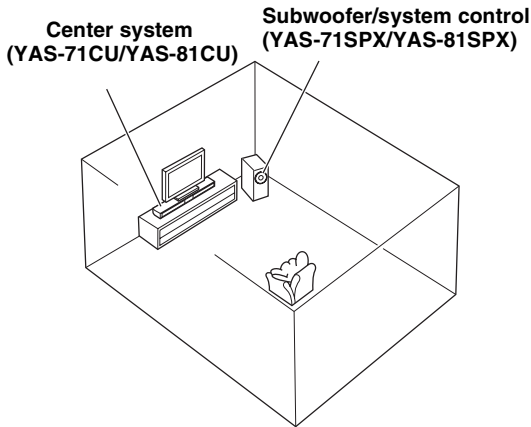

Center system (YAS-71CU/YAS-81CU)

Place the center system beneath a TV or under the TV so that the center system and your TV align vertically. Make sure that the center system is placed in parallel with the wall.

Main roles: Produces front channel (stereo) sounds. Also produces virtual center channel sounds (dialogue, etc.) and virtual surround channel sounds effectively using the Yamaha front surround system.

Subwoofer/system control (YAS-71SPX/YAS-81SPX)

Place the subwoofer near the center system and turn it slightly toward the center of the room to reduce wall reflections.

Main roles: Produces low frequency (LFE) sounds.

Notes

- This system is shielded against magnetic fields. However, if the picture on your TV screen becomes blurred or distorted, we recommend moving the system away from your TV.
- Low frequency sound produced by the subwoofer/system control may be heard differently depending on the listening position and subwoofer location. To enjoy desired sounds, try changing the location of the subwoofer.
- Depending on your installation environment, connections to external components can be done before installing this system. We recommend that you temporarily place and arrange all components in order to decide which procedure is best done first.

Placing the center system

You can place the center system on a rack or attach it to a wall. Select an installation method that suits your environment.

■ Placing the center system beneath/under a TV

Example 1:
Beneath your TV

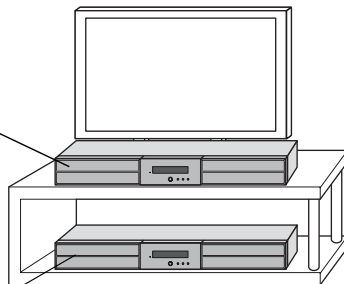

Example 2: Under your TV

- 1 Attach the supplied double-sided tapes on the spacers and non-skid pads on the rear of the spacers.**

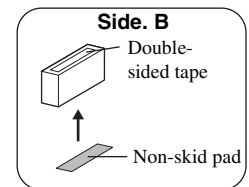
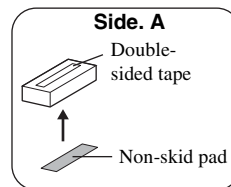

- 2 Attach the spacers to the bottom.**

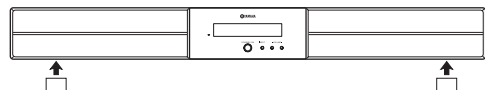

If there is any obstacle (TV stand, etc.) under the center system, use the supplied spacers as follows.

Notes

- Do not cover the remote control sensor of your TV, etc., by the center system.
- The spacers may scratch or damage the surface of your rack or floor. Be careful when placing or moving the center system.
- For your safety, take measures in advance to prevent the center system from falling.

■ Attaching the center system to a wall

Installing the center system using the keyholes

You can attach the center system to a wall using commercially available screws (#8, Diameter: 7.5 mm or more (5/16" or more)).

When installing the center system on a wall, all installation work must be performed by a qualified contractor or dealer. The customer must never attempt to perform this installation work. Improper or inadequate installation could cause the center system to fall, resulting in personal injury.

- 1 Attach the supplied mounting template on a wall and mark the holes of the mounting template.**

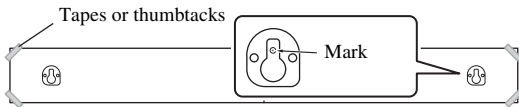

- 2 Remove the mounting template and then install the commercially available screws at the marks.**

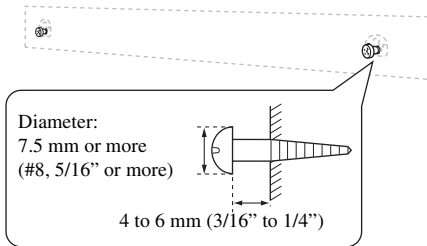

To install the cables above the center system, refer to the right column.

- 3 Hang the center system on the screws using the keyholes on the back of the center system.**

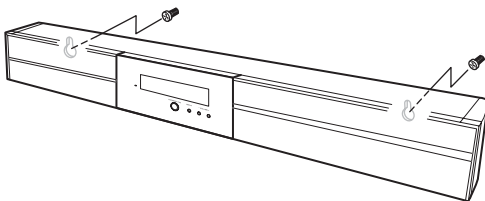

Installing the cables above the center system

To pass the cables upward, you need to attach the spacers to make room on the back of the center system.

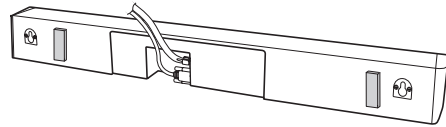

In step 2 of the left column;

- 2-a:** Attach the supplied spacers to the rear panel of the center system using the supplied double-sided tapes. You can choose either the side A or the side B.

A: For narrow space

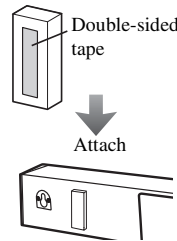

B: For wide space

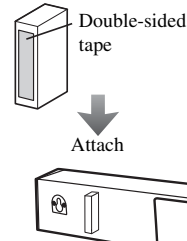

- 2-b:** Remove the mounting template and then install the commercially available screws at the marks.

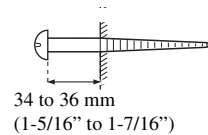
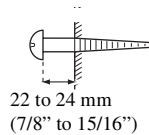

Installing the center system using the screw holes

You can also use the inner or outer screw holes on the rear of the center system for installing the center system using a commercially available bracket or rack.

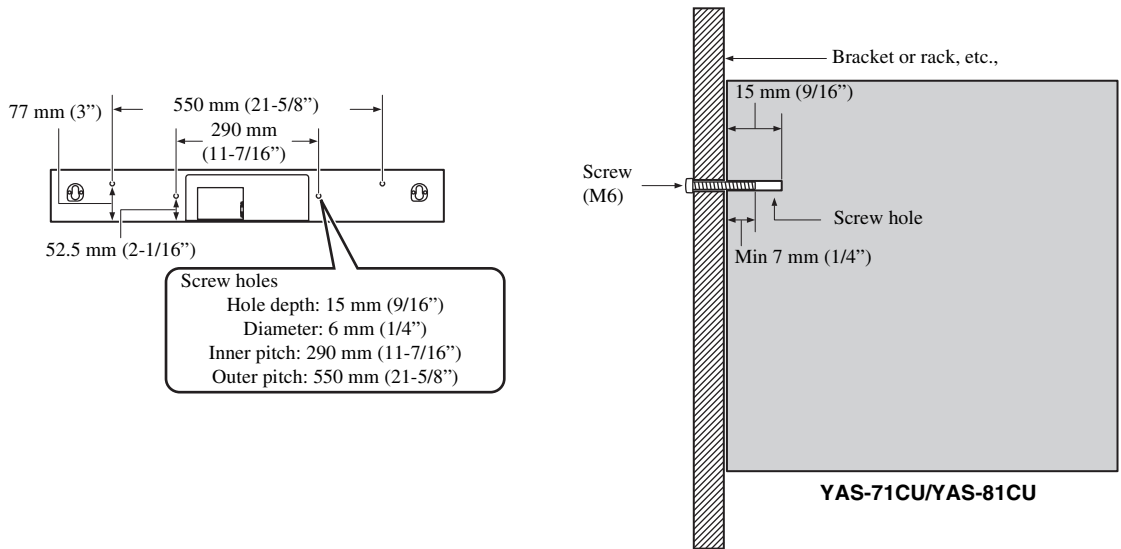

Notes

- The center system weighs about 5 kg (11 lbs.) for YAS-71 and 6 kg (13 lbs. 4 oz.) for YAS-81. Attach the center system to a bracket, rack or wall. Do not attach the center system to a wall that is made of weak materials such as plaster or veneered woods. Doing so may cause the center system to fall.
- Use commercially available screws that can support the weight of the installation.
- Make sure you use specified screws to attach the center system. Using clamps other than specified screws, such as short screws, nails, or two-sided tape, may cause the center system to fall.
- When connecting the center system, fix the speaker cables in place where they will not become loose. If your foot or hand accidentally gets caught on a loose speaker cable, the center system may fall.
- After attaching the center system, check that the center system is fixed securely. Yamaha will bear no responsibility for any accidents caused by improper installations.

CONNECTION

- Do not connect the power cable until all connections are completed.
- Do not use excessive force when inserting the cable plug. Doing so may damage the cable plug and/or terminal.

Connecting the center system and the subwoofer/system control

Follow the procedure below to connect the center system and the subwoofer/system control.

Connecting speaker cables

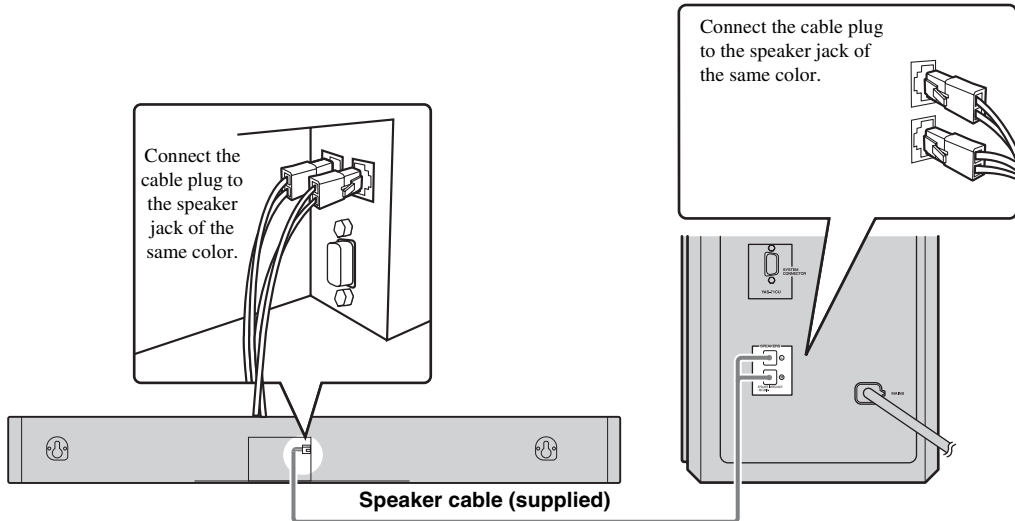

It is possible to route the supplied speaker cable behind a wall. (For US customers only)

Connecting system control cable

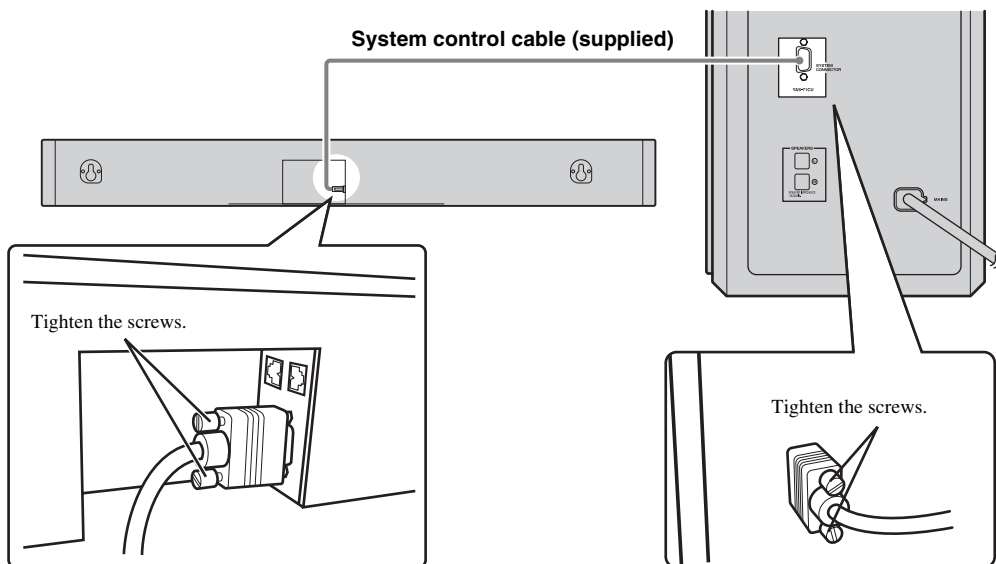

It is possible to route the supplied system control cable behind a wall. (For US customers only)

Connecting external components

The subwoofer/system control has 3 digital input jacks (optical digital × 2, coaxial digital × 1) and 1 analog input jack. Before connecting your external components, check the output jacks of the components and be sure to use correct connection cables.

■ Digital connection

Notes

- The digital jacks of this system support PCM, Dolby Digital, and DTS bitstream.
- The digital jacks support digital signals of 96 kHz sampling frequency or less.

[INPUT 1, 2] OPTICAL jack

Example 1: DVD player

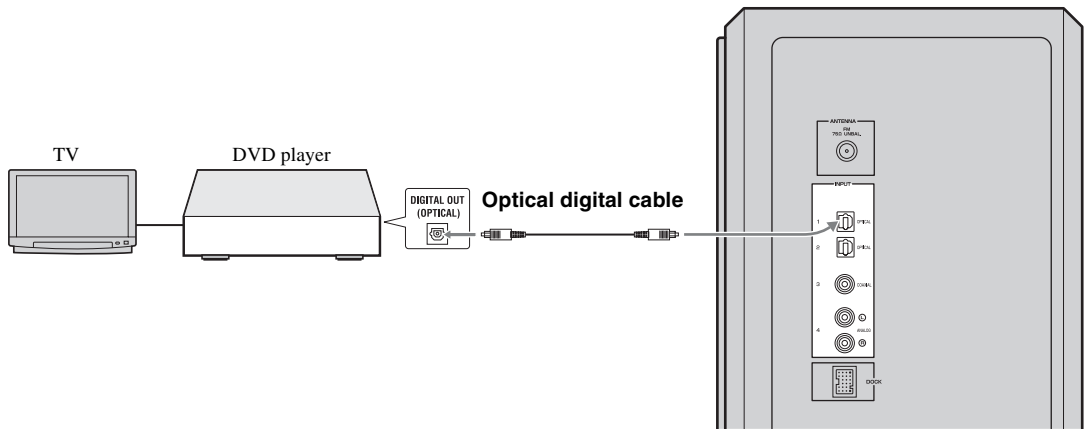

Example 2: TV game console

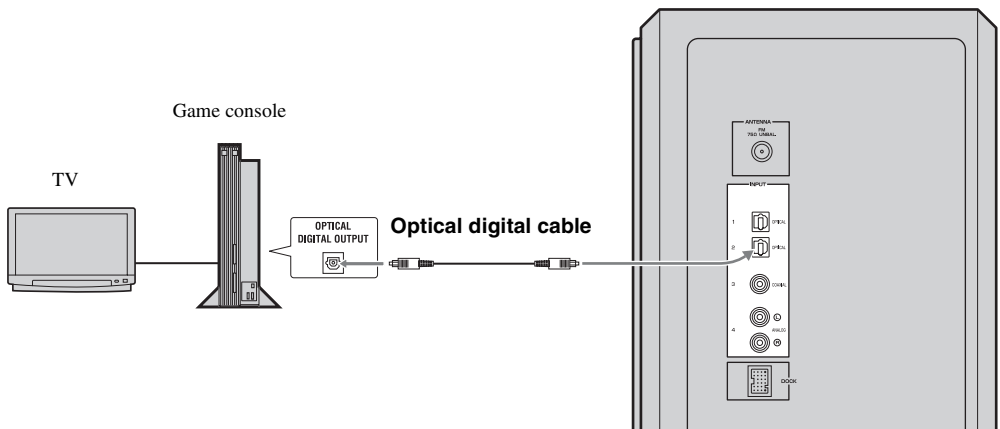

[INPUT 3] COAXIAL jack

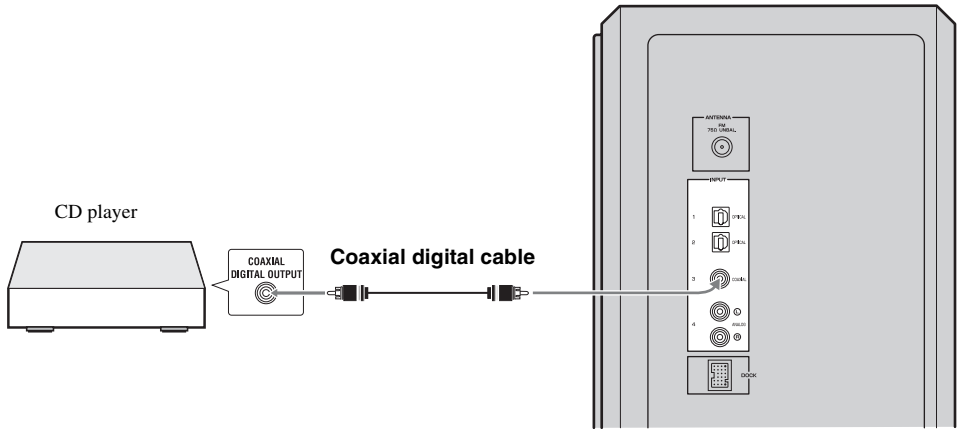

PREPARATION

■ Analog connection

[INPUT 4] ANALOG jacks

Example 1: TV

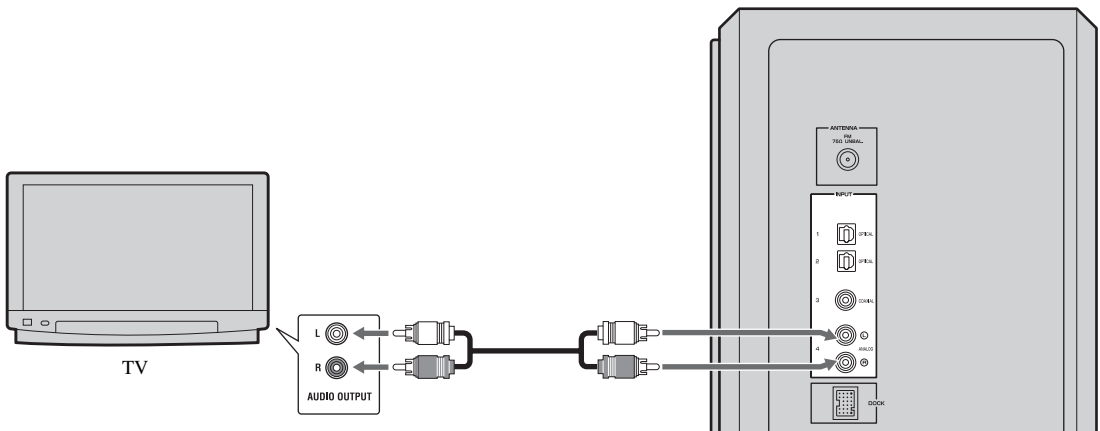

Example 2: VCR or video camera

VCR or video camera, etc., with no digital output.

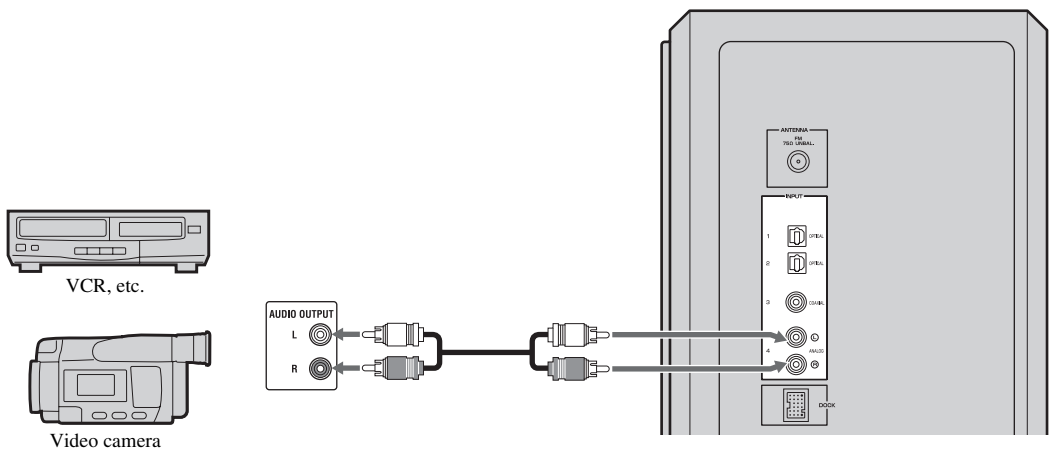

English

Connecting the Yamaha iPod universal dock

The system is equipped with the DOCK terminal, which allows you to connect the Yamaha iPod universal dock (such as YDS-10 or YDS-11, sold separately) where you can dock your iPod. Connect the Yamaha iPod universal dock to the DOCK terminal of the subwoofer/system control using its dedicated cable. Refer to “Using iPod™” on page 27 for details.

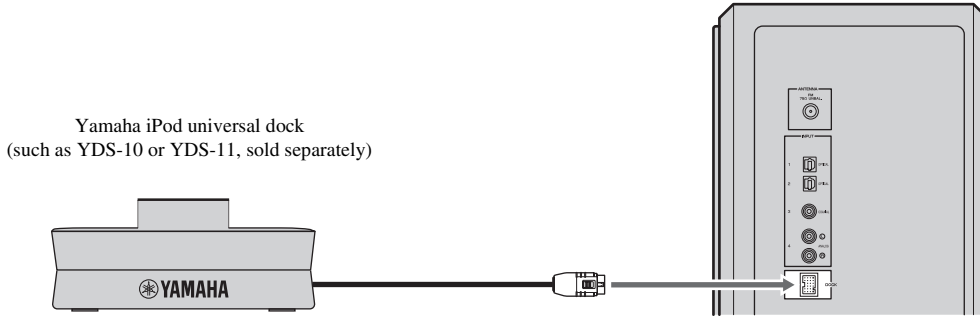

Connecting the Yamaha Bluetooth wireless audio receiver

You can also connect the Yamaha Bluetooth wireless audio receiver (such as YBA-10, sold separately) to the DOCK terminal. Connect the Yamaha Bluetooth wireless audio receiver to the DOCK terminal of the subwoofer/system control using its dedicated cable. Refer to “Using Bluetooth™ Components” on page 29 for details.

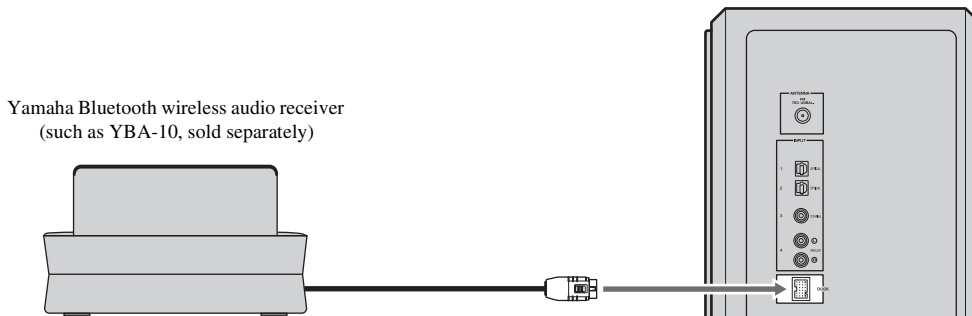

Connecting the indoor FM antenna

To enjoy FM radio broadcasts, connect the supplied indoor FM antenna.

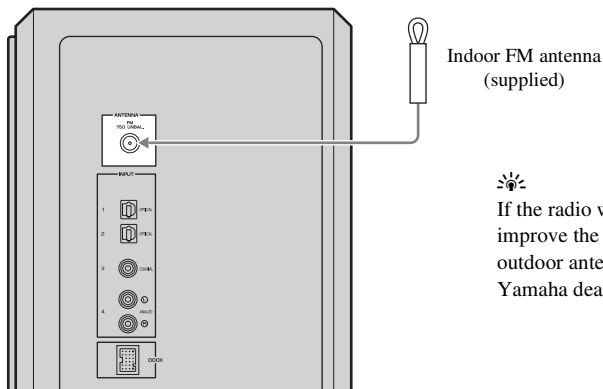

If the radio wave reception is weak in your area or you want to improve the radio wave reception, we recommend that you use an outdoor antenna. For details, consult your nearest authorized Yamaha dealer or Service Center.

Connecting the power cable

After you have made all connections, connect the power cable of the subwoofer/system control.

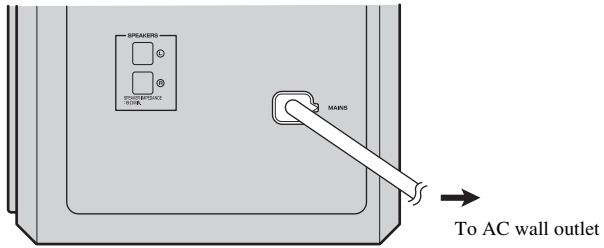

You can attach the cover after you have made all connections or detach according to your preference. Attach the cover to the rear panel of the subwoofer/system control using the 6 supplied screws as shown.

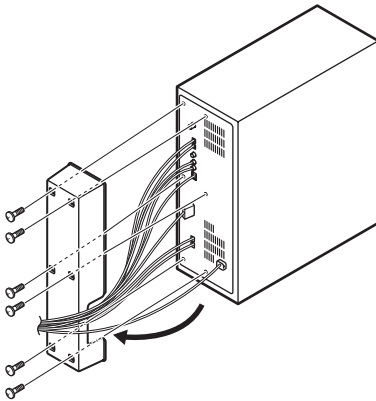

BASIC PLAYBACK OPERATION

Once you have finished all cable connections (P. 11 to 15) and remote control preparation (P. 7), follow the procedure below to start basic playback operation.

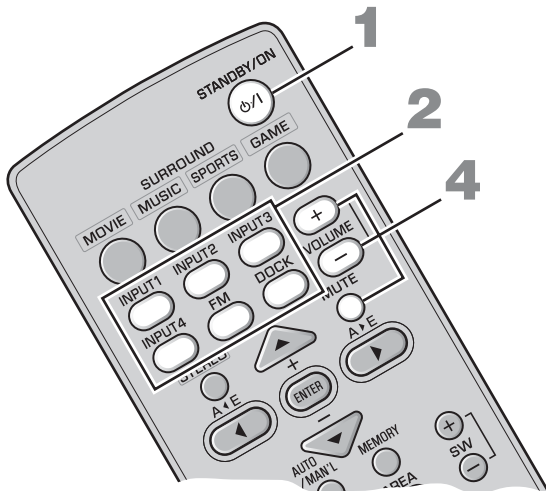

1 Press **STANDBY/ON**.

This system is turned on and the power indicator lights up. To set the system to standby mode, press **STANDBY/ON** again.



This system has the auto-sleep function, which will automatically switch the system to standby mode if the system is left turned on for 24 hours without any operation being performed.

2 Press one of the input buttons to select an input source.

For example, if a DVD player is connected to the INPUT 1 jack of the subwoofer/system control, press **INPUT 1** to select the DVD player.



You can also switch the input source by pressing INPUT on the center system repeatedly. The input source changes as follows:



3 Start playback on the selected external component.

For information on the external component, refer to the manual for the product.

4 Press **VOLUME +/-** to adjust the volume level.



To turn off the volume temporarily, press **MUTE**. While the mute function is activated, the MUTE indicator flashes. To resume the volume, press **MUTE** again.

Now, try various features of this system!

Using various sound features

- To enjoy highly realistic sounds with surround mode P. 18
- To shift the optimum listening area from side to side P. 19
- To select the optimum listening area P. 20
- To experience wider stereo sound when surround mode is not activated P. 21
- To play back compressed audio signals with high-quality sound P. 21
- To delay the sound output in order to synchronize it with the video image P. 31
- To enjoy various input sources at lower volume P. 32

Enjoying FM broadcasts/ optional equipment

- To listen to FM broadcasts P. 22
- To control iPod playback P. 27
- To play back a Bluetooth component P. 29

AIR SURROUND XTREME

What is AIR SURROUND XTREME ?

Ordinarily, two front speakers, a center speaker, two surround speakers, and a subwoofer are necessary for enjoying 5.1 channel surround sound.

■ Virtual 7.1 channel

The AIR SURROUND XTREME technology, using only the front left and right speakers of the center system and subwoofer, enables you to enjoy a realistic 7.1 channel sound by simulating sound from virtual speakers at center, surround, and surround backs.

Typical 5.1 channel speaker system

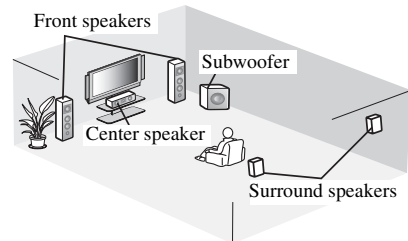

The sound image of the system

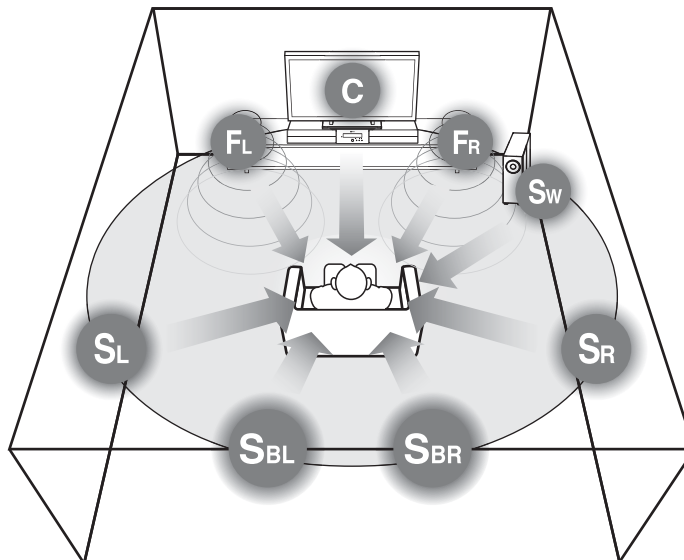

The system creates the virtual 7.1 channel surround sound with the center system and the subwoofer/system control.

C: Center virtual speaker

FR, FL: Front speakers

SW: Subwoofer

SR, SL: Surround virtual speakers

SBR, SBL: Surround back virtual speakers

You can check the virtual surround effect and adjust the volume balance according to your preference and the characteristics of your listening room. See the following pages for details.

• **Checking the virtual surround effect** ⓘ P. 20

• **Adjusting the volume balance** ⓘ P. 32

Use this feature to adjust the volume balance of the subwoofer, center, and surround channels during playback.

Listening to surround mode of AIR SURROUND XTREME

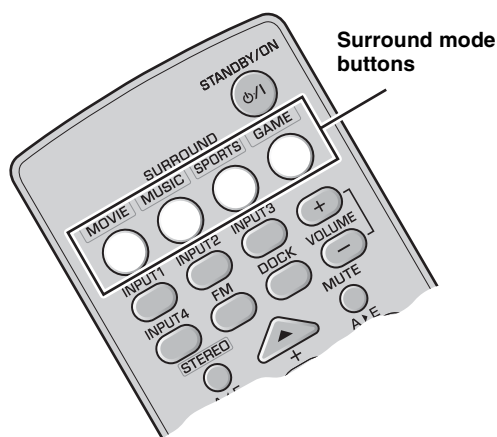

Press one of the surround mode buttons.

The names of the selected input source and the selected surround mode appear in the front panel display.

INPUT1 : MOVIE

Surround mode descriptions

Movie



This mode is useful when you enjoy movie contents on media such as DVD, etc.

Music



This mode is useful when you listen to music contents on media such as DVD, etc.

Sports



This mode is useful when you enjoy sports programs or TV news.

Game



This mode is useful when you enjoy video games.



- To reproduce the original sounds, press **STEREO**.
- The system automatically memorizes the settings assigned to each input source. When you select another input, the system automatically recalls the last settings for the selected input.

Shifting the optimum listening area from side to side

This function shifts the optimum listening area from side to side according to your listening position for the best Virtual Surround effect.

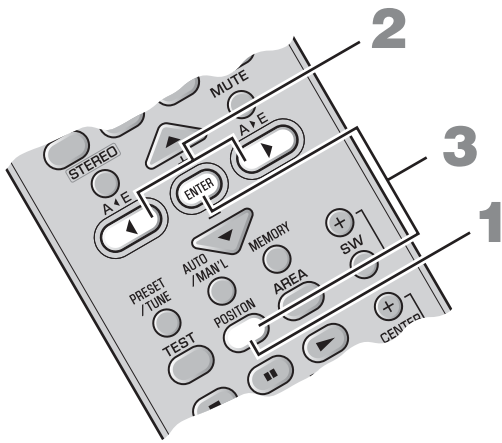

1 Press **POSITION** to enter position mode.
The current position appears in the front panel display.

2 Press **◀▶** to shift the optimum listening area (L6, L5, L4, L3, L2, L1, CENTER, R1, R2, R3, R4, R5, R6).

Adjust the optimum listening area from L1 to L6 when your listening position is to the left side of the center system, and adjust the optimum listening area from R1 to R6 when your listening position is to the right side of the center system.

The position appears in the front panel display.

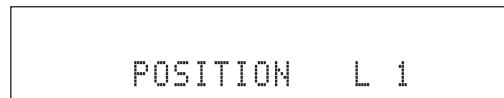

Example: "POSITION L1"

3 Press **POSITION** again or **ENTER** to exit position mode.



- The default setting is CENTER.
- If you press **TEST** after performing step 1, the system outputs the test tone for a virtual center speaker so you can adjust the position setting. (P. 20)
- The setting is set for all the input sources.
- This function is available even when surround mode is off.

Note

If you do not operate this function within 30 seconds after entering position mode, the system automatically exits position mode.

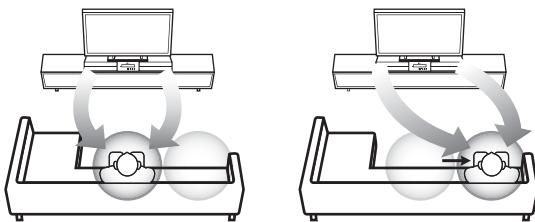

The optimum listening area

Selecting the optimum listening area

You can select the optimum listening area from two modes.

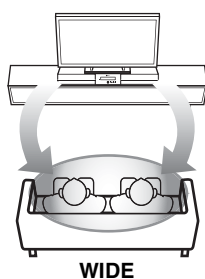
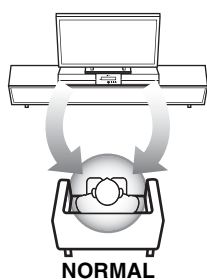
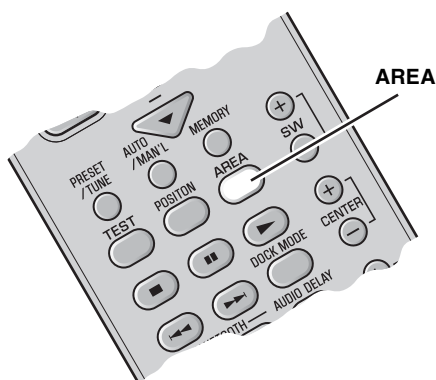

Press **AREA**.

Each time you press **AREA**, **NORMAL** and **WIDE** modes change alternately.

NORMAL

Select this to sharpen the sound effect.

“AREA NORMAL” appears in the front panel display when **NORMAL** mode is selected.

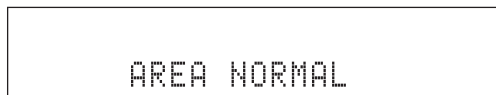

WIDE

Select this to widen the optimal listening area.



- The default setting is **NORMAL**.
- The setting is set for all the input sources.

Note

This operation is only available when surround mode is activated.

Checking the virtual surround effect

You can check the Virtual Surround effect using test tones produced from the speakers.

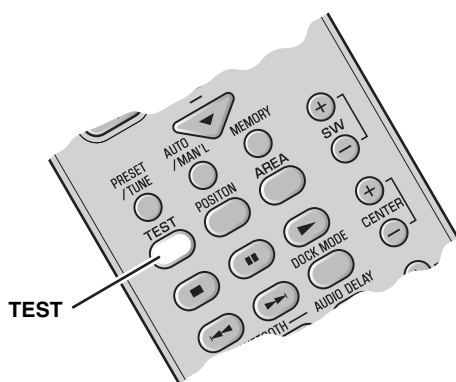

Press **TEST** to output the test tone.

The system outputs the test tone and the output channel of the test tone appears in the front panel display.



**Active (virtual)
speaker channel**

The output channel of the test tone cycles through as follows. Each channel outputs the test tone for about 2 seconds.



To cancel test tone mode, press **TEST** again.

Note

The surround back virtual speaker is included in **SL** and **SR**.

Using extended stereo mode

An extended sound is achieved for a 2 channel source such as a CD player.

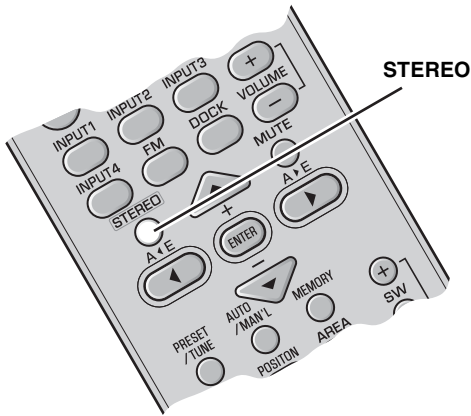

Press **STEREO** to enter extended stereo mode.

“EXTENDED” appears in the front panel display.



Each time you press **STEREO**, the function is turned on (EXTENDED) and off (STEREO) alternately.



- The default setting is STEREO.
- The system memorizes the settings assigned to each input source.
- You can also turn on compressed music enhancer mode when extended stereo mode is turned on.

Note

This operation is only available when surround mode is not activated.

Setting compressed music enhancer

This function enhances your listening experience by regenerating the missing harmonics in a compression artifact. This is useful when you play back compressed music data stored on an iPod or a digital music player.

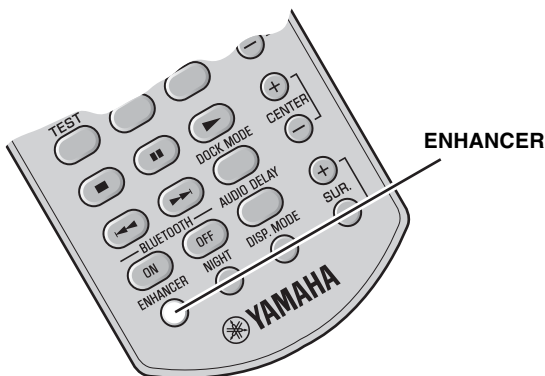

Press **ENHANCER**.

The ENHANCER indicator lights up in the front panel display when this function is turned on.

Each time you press **ENHANCER**, the function is turned on and off alternately. The selected mode is stored in memory even when the power is off.



- The default setting is OFF.
- The system memorizes the settings assigned to each input source.
- When this function is on, night listening mode is automatically set to off. (P. 32)

LISTENING TO FM BROADCASTS

Overview

You can use two tuning modes to tune into the desired FM station:

Frequency tuning mode

You can search or specify the frequency of the desired FM station automatically or manually. (See “Basic tuning operation” on page 23.)

Preset tuning mode

You can preset the desired FM station in advance, and then recall the station by specifying the preset group and number. (See “Using station preset feature” on page 24.)

Controls and functions for the FM tuning

A◀E/A▶E

Selects the preset group (A to E).

PRESET/TUNE

Switches between frequency tuning mode and preset tuning mode.

AUTO/MAN'L

Switches between automatic and manual tuning mode.

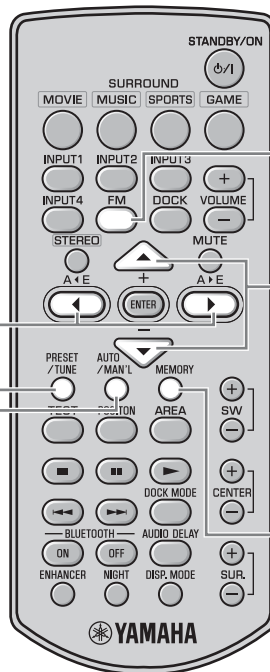

FM

Sets the input to FM.

+/-

- Selects the desired frequency in frequency tuning mode.
- Selects the desired preset number (1 to 8) in preset tuning mode.

MEMORY

Activates the preset memory mode.

Basic tuning operation

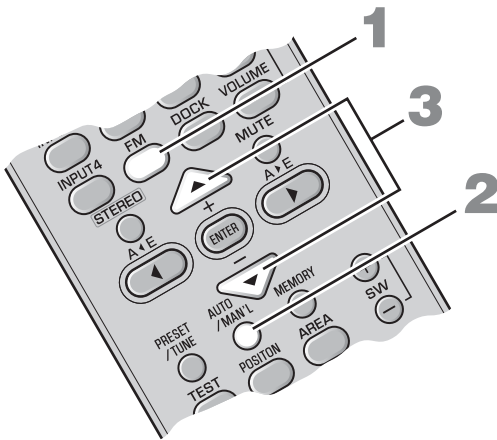

1 Press **FM** to set the input to FM.

“FM” appears in the front panel display.



2 Press **AUTO/MAN'L** to switch Auto/Manual.

The AUTO indicator lights up when the system is set to automatic tuning mode.

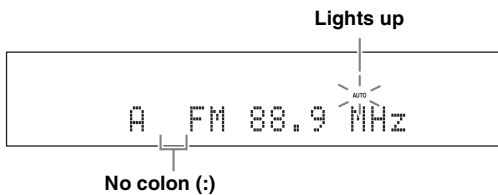

If a colon (:) appears, the system is set to preset tuning mode. (P. 24)

3 Press **+/-** once to begin automatic tuning.

When the system is tuned to a station, the TUNED indicator lights up and the frequency of the received station is shown in the front panel display.

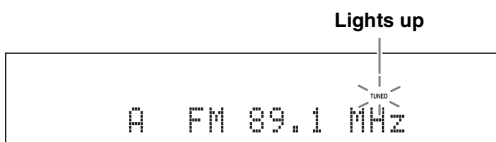

When you tune to an FM station using automatic tuning mode, the system receives the FM radio signal in stereo reception mode. The STEREO indicator appears in the front panel display.

Manual tuning

If the signal received from the station you want to select is weak, you can tune into the desired station by specifying the frequency manually. In FM tuning mode, press **AUTO/MAN'L** repeatedly so that the AUTO indicator disappears, and then press **+/-** repeatedly to specify the frequency of the desired station.

If you tune to a station using the manual tuning feature, the system receives the FM radio signals in monaural reception mode to increase signal quality.

Using station preset feature

Automatic station preset

You can store up to 40 FM stations (A1 to E8: 8 preset numbers in each of the 5 preset groups).

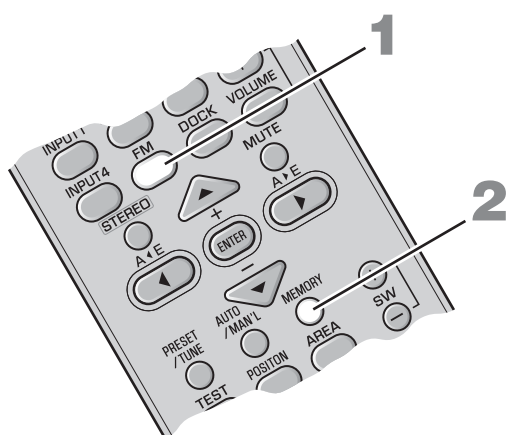

1 Press **FM** to set the input to FM.

“FM” appears in the front panel display.

2 Press and hold **MEMORY** for more than 3 seconds.

The preset group and number as well as the MEMORY and AUTO indicators flash. After approximately 5 seconds, automatic presetting starts from the current frequency and proceeds through higher frequencies.

Press **MEMORY** again to cancel while the MEMORY indicator is flashing.

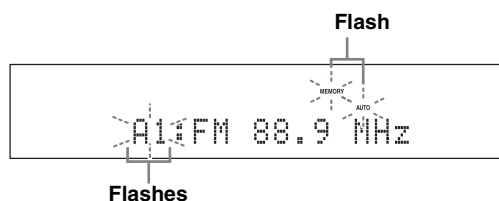

When automatic preset tuning is completed, the front panel display shows the frequency of the last preset station.



Press **A◀E** or **A▶E** to select a preset group, and then press **+/-** repeatedly to select a preset number to which the first station will be stored after you perform step 2.

Notes

- Any stored station data existing under a preset number is cleared when you store a new station under the same preset number.
- If the number of received stations does not reach 40 (A1 to E8), automatic preset tuning automatically stops after searching for all the available stations.

If the desired station is not stored, or a station is not stored to the desired preset group and number, preset the station manually. Refer to “Manual station preset” on page 25 for details.

Manual station preset

Use this feature to preset your desired station manually.

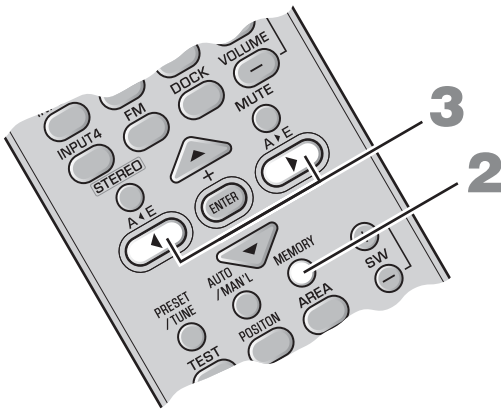

1 Tune into a station.

See “Basic tuning operation” on page 23 for tuning instructions.

2 Press **MEMORY**.

The MEMORY indicator flashes in the front panel display for approximately 30 seconds.

Press **MEMORY** again to cancel while the MEMORY indicator is flashing.

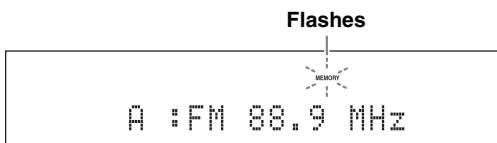

3 Press **A◀E** or **▶E** repeatedly to select a preset group (A to E) while the MEMORY indicator is flashing.

The selected preset group appears.

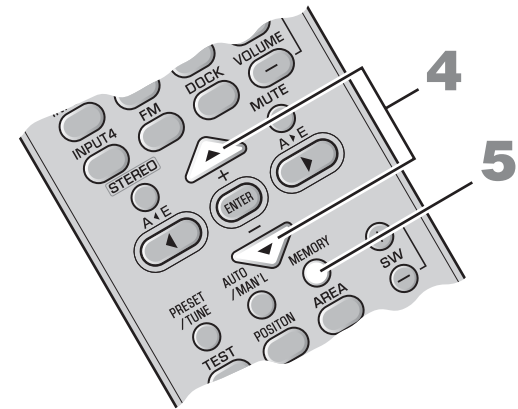
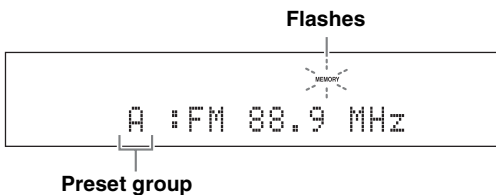

4 Press **+/-** to select a preset number (1 to 8) while the **MEMORY** indicator is flashing.

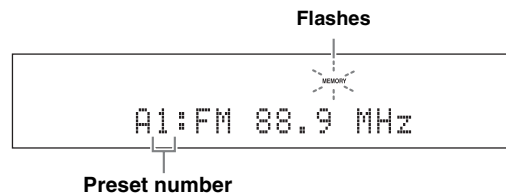

5 Press **MEMORY** to confirm the preset.



The selected station has been stored as A1.

After “A1:PRESET OK” appears in the front panel display, the frequency appears with the preset group you selected. The MEMORY indicator disappears from the front panel display.

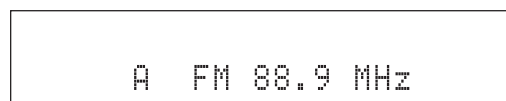

Notes

- Any stored station data existing under a preset number is cleared when you store a new station under the same preset number.
- Reception mode (stereo or monaural) is stored along with the station frequency.

■ Recalling the preset stations

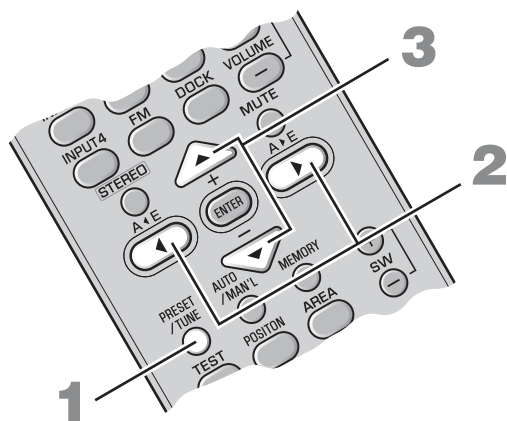

- 1** Press **PRESET/TUNE** to select preset tuning mode.
- 2** Press **A<E** or **A>E** repeatedly to select the desired preset group (A to E).
- 3** Press **+/-** repeatedly to select the desired preset number (1 to 8).

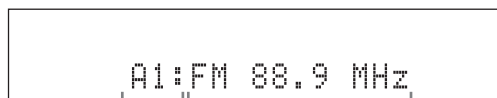

Preset group and number

Preset FM station

USING OPTIONAL EQUIPMENT

Using iPod™

Once you have stationed your iPod in the Yamaha iPod universal dock (such as YDS-10/ YDS-11, sold separately) connected to the DOCK terminal of the subwoofer/system control (P. 14), you can enjoy playback of your iPod.

Supported iPod

iPod (Click and Wheel)
iPod nano
iPod mini
iPod touch

Battery charge feature

This system charges the battery of an iPod stationed in the Yamaha iPod universal dock connected to the DOCK terminal of the subwoofer/system control while this system is turned on.

Stationing your iPod in the Yamaha iPod universal dock

Once you station your iPod in the Yamaha iPod universal dock, “iPod connected” and the DOCK indicator appear in the front panel display.

Notes

- Some features may not be available depending on the model or the software version of your iPod.
- For a complete list of status messages that appear in the front panel display, see the “iPod” section in “Troubleshooting” on page 35.
- Be sure to set the volume to minimum before docking or removing your iPod.

■ Controls and functions for iPod™

You can control your iPod in simple remote mode or menu browse mode.



You can switch between simple remote mode and menu browse mode by pressing **DOCK MODE**.

DOCK

Set the input to DOCK.

Playback control buttons

Control the playback of the connected iPod.

- ▷: Play/pause (Simple remote mode), Play (Menu browse mode)
- ⏏: Play/pause (Simple remote mode), Pause (Menu browse mode)
- ⏏: Stop
- ⏮/⏭: Skip backward/forward
- ⏮/⏭: Search backward/forward (Press and hold)

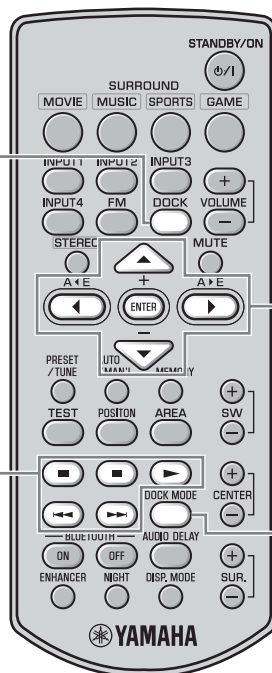

MENU/Cursor buttons (▲/▼/◀/▶)/ENTER

Navigate the menu of your iPod.

- Press ◀ to move to an upper menu level.
- Press ▲/▼ to move the cursor to select a menu.
- Press ENTER or ▶ to enter the selected menu.
- Press ENTER in the “Songs” level menu screen to play back the selected song.

DOCK MODE

Switch simple remote mode and menu browse mode.

■ Controlling your iPod in simple remote mode

Docking your iPod in the Yamaha iPod universal dock (such as YDS-10 or YDS-11, sold separately) enters simple remote mode. You can perform the basic operations of your iPod (play, stop, skip backward/forward, etc.) using the supplied remote control in this mode.



Operations can be also done with the controls on your iPod. Refer to the instruction manuals of your iPod for its operations.

■ Controlling your iPod in menu browse mode

The song lists or playback information is displayed in the front panel display so that you can select and play back songs or adjust settings using the supplied remote control in this mode.

Notes

- Operations cannot be done with the controls of your iPod.
- Characters that cannot be displayed in the front panel display are replaced with underscores “_”.

1 Press **DOCK MODE** to enter menu browse mode.

2 Press **▲/▼/◀/▶** repeatedly to select the desired menu, and then press **ENTER** to play back the selected song.

Options	Level 1	Level 2	Level 3	Level 4
Playlists	Playlist	Song list		
Artists	Artist list	Album list	Song list	
Albums	Album list	Song list		
Songs	Song list			
Genres	Genre list	Artist list	Album list	Song list
Composers	Composer list	Album list	Song list	
Settings	Setting list			

The setting list has the following 2 choices.

Shuffle

Use this feature to set the system to play songs or albums in random order.

Options: Off, Songs, Album

You can switch each option by pressing **ENTER**.

- Select “Off” to deactivate this feature.
- Select “Songs” to set the system to play songs in random order.
- Select “Album” to set the system to play albums in random order.

Repeat

Use this feature to set the system to repeat one song or a sequence of songs.

Options: Off, One, All

You can switch each option by pressing **ENTER**.

- Select “Off” to deactivate this feature.
- Select “One” to set the system to repeat one song.
- Select “All” to set the system to repeat a sequence of songs.

Note

The contents of the iPod menu vary, depending on the model or the generation.

Using Bluetooth™ components

You can connect the Yamaha Bluetooth wireless audio receiver (such as YBA-10, sold separately) to the DOCK terminal of the subwoofer/system control and enjoy the music contents stored in your Bluetooth component (such as a portable music player or computer equipped with a Bluetooth transmitter, etc.) without wiring between the system and the Bluetooth component. You need to perform “pairing” of the connected Yamaha Bluetooth wireless audio receiver and your Bluetooth component in advance.

■ Controls and functions for Bluetooth components

DOCK

Set the input to DOCK.

BLUETOOTH ON/OFF

- Start or cancel the pairing.
- Connect or disconnect a Bluetooth component.

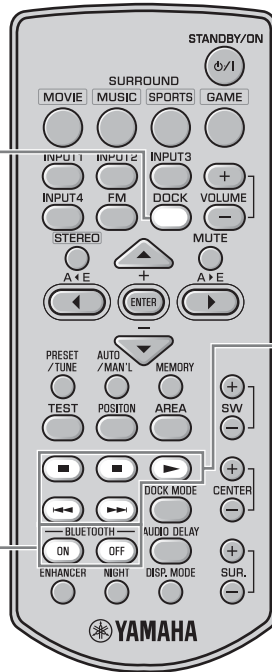

Playback control buttons

Control the playback of a Bluetooth component.

- ▷: Play
- ⏸: Pause
- ⏹: Stop
- ⏮/⏭: Skip backward/forward

■ Pairing the Yamaha Bluetooth™ wireless audio receiver and your Bluetooth™ component

Pairing must be performed before using a Bluetooth component with the Yamaha Bluetooth wireless audio receiver connected to the system for the first time or if the registered pairing data has been deleted. “Pairing” refers to the operation of registering a Bluetooth component for Bluetooth communications.

To ensure security, a time limit of 8 minutes is set for the pairing operation. Please read and fully understand all the instructions before starting.

- 1** Connect the Yamaha Bluetooth wireless audio receiver to the DOCK terminal of the subwoofer/system control. (P. 14)
- 2** Press **DOCK** to set the input to DOCK.
- 3** Turn on the Bluetooth component you want to pair with, and then enter pairing mode. Refer to the instruction manual of your Bluetooth component for details.

4 Press and hold **BLUETOOTH ON for more than 3 seconds to start pairing.**

“Searching...” appears when the pairing starts. While the Yamaha Bluetooth wireless audio receiver is in pairing mode, the DOCK indicator flashes in the front panel display.



To cancel the pairing, press **BLUETOOTH OFF**.

5 Check that the Bluetooth component detects the Yamaha Bluetooth wireless audio receiver.

If the Bluetooth component detects the Yamaha Bluetooth wireless audio receiver, the audio receiver name (“YBA-10 YAMAHA” for example) appears in the device list of the Bluetooth component.

6 Select the Yamaha Bluetooth wireless audio receiver in the device list of the Bluetooth component, and then enter the pass key “0000” on the Bluetooth component.

When the pairing procedure is successful, “Completed” appears in the front panel display.



- If the pairing is not completed within 8 minutes, “Not found” appears and the DOCK indicator is turned off in the front panel display.
- If the pairing is canceled during the pairing, “Canceled” appears in the front panel display.

Note

The Yamaha Bluetooth wireless audio receiver can be paired with up to eight Bluetooth components. When pairing is conducted successfully with a ninth component and the pairing data is registered, the pairing data for the least recently used another component is deleted.

■ Establishing a connection

After the pairing is completed, perform the connecting operation on the system or on the Bluetooth component to enable communication between them. The connecting operation on the system is only available for the most recently connected Bluetooth component.

1 Press **DOCK to set the input to DOCK.**

2 Press **BLUETOOTH ON to start a connection. “Searching...” appears in the front panel display.**

When the system finds the last connected Bluetooth component, “BT connected” appears in the front panel display for 3 seconds.



- If the system cannot find the last connected Bluetooth component, “Not found” appears in the front panel display.
- If you want to establish a connection with a Bluetooth component other than the one most recently connected to, connect from that Bluetooth component. Refer to the instruction manual of your Bluetooth component for details.

■ Disconnecting

Press **DOCK, and then **BLUETOOTH OFF** to disconnect the system from the Bluetooth component.**

“Disconnected” appears in the front panel display.

■ Playing back the Bluetooth component

You can play back your Bluetooth component using the supplied remote control.

You can also play back your Bluetooth component by operating it directly.



Operation using the remote control is available only when the connection is established between the Bluetooth component you want to play back and the system.

ADJUSTING THE AUDIO DELAY

FPD TV images sometimes lag behind the sound. You can use this function to delay the sound output to synchronize it with the video image.

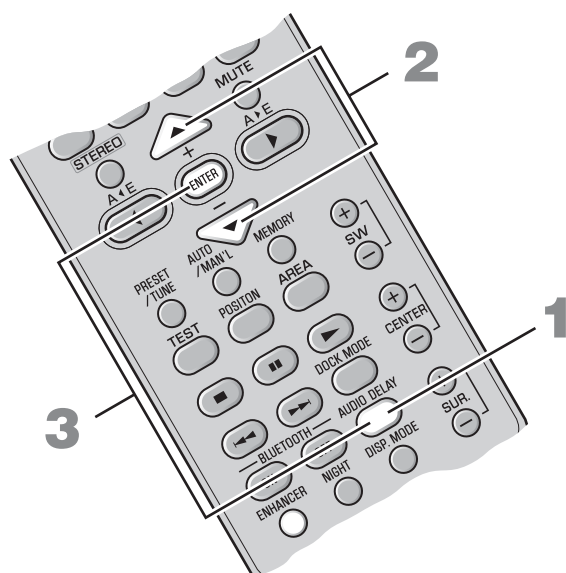

1 Press **AUDIO DELAY** to enter adjusting mode.

2 Press **▲/▼** to adjust the delay time.

Options: 0 to 240 ms

You can adjust the delay time by the 10 ms.

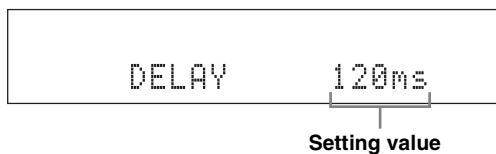

3 Press **AUDIO DELAY** again or **ENTER** to exit adjusting mode.



- The default setting is 0 ms and “DELAY OFF” appears in the front panel display.
- The system memorizes the settings assigned to each input source.

Note

If you do not operate this function within 30 seconds after entering adjusting mode, the system automatically exits adjusting mode.

LISTENING AT LOW VOLUME (NIGHT LISTENING MODE)

Night listening mode enables you to listen to dialog or vocals more clearly at lower volume by suppressing louder sound effects. This function is useful when you enjoy movies or music at night.

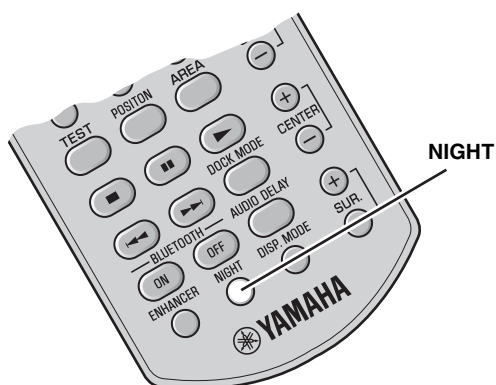

Press **NIGHT**.

“NIGHT ON” appears in the front panel display. The NIGHT indicator lights up when Night listening mode is selected.

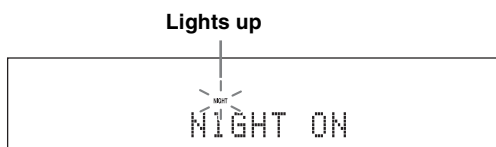

- To cancel night listening mode, press **NIGHT** again.
- When this function is on, compressed music enhancer mode is automatically set to off. (P. 21)
- The setting is set for all the input sources.

ADJUSTING THE VOLUME BALANCE DURING PLAYBACK

You can adjust the volume balance of the virtual speakers and subwoofer.

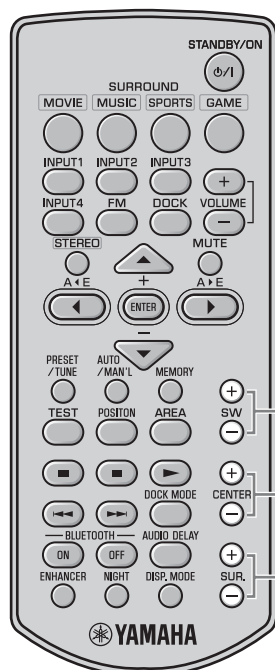

SW +/-

Adjusts the output level of the subwoofer channel.
Control range: +6 to -6

CENTER +/-

Adjusts the output level of the center virtual speaker channel.
Control range: +6 to -6

SUR. +/-

Adjusts the output level of the surround/surround back virtual speaker channels.
Control range: +6 to -6



- You can also adjust the speaker volume while the test tone is output. (P. 20)
- The setting is set for all the input sources.

CHANGING THE BRIGHTNESS OF THE FRONT PANEL DISPLAY

You can change the brightness of the front panel display. You can also turn off the front panel display to view a movie in a darker environment.

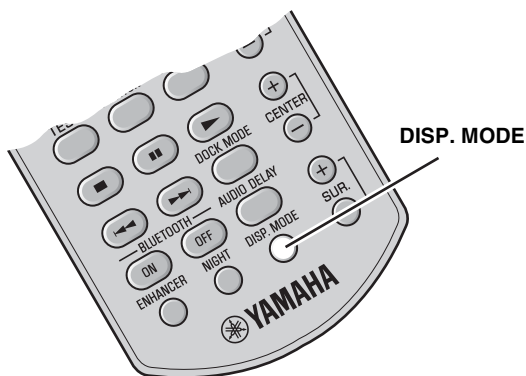

Press **DISP. MODE** repeatedly.

Each time you press **DISP. MODE**, the brightness of the front panel changes.

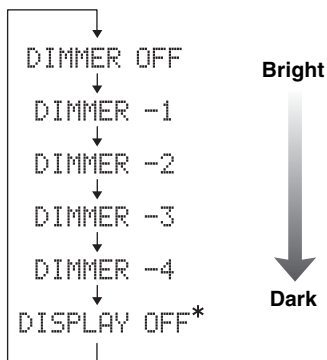

* Selecting **DISPLAY OFF** turns off the front panel display after “DISPLAY OFF” appears in the front panel display.

The front panel display lights up momentarily when any operation is performed with **DISPLAY OFF** mode selected.

Only the power indicator remains lit in **DISPLAY OFF** mode.



The default setting is **DIMMER OFF**.

ADDITIONAL INFORMATION

Troubleshooting

If there is any problem with the system, check the following items. If you cannot solve a problem with the following remedies, or if the problem is not listed below, turn off and unplug the system, and then consult your nearest authorized Yamaha dealer or Service Center.

Problem	Cause	Solution	See page
Power turns on but immediately shuts off.	The power cable may be connected improperly.	Make sure the power cable is plugged into the outlet firmly.	15
	A speaker cable may be shorted.	Make sure all speaker cables are connected properly.	11
	This system may have received a strong electrical shock, such as from a lightning bolt or excessive static electricity.	Set this system to standby mode, and then disconnect the power cable. Wait for about 30 seconds, connect the power cable, and then turn the system on again.	16
The speakers make no sound.	The volume may be set to minimum level.	Adjust the volume level.	16, 32
	The mute function may be activated.	Cancel the mute function.	16
	The input source or input setting may be incorrect.	Select the correct input source or input setting.	16
	The cables may be connected improperly.	Make sure all cables are connected properly.	11
Sound is too low on one side.	The cables may be connected improperly.	Make sure all cables are connected properly.	11
Speaker channels other than the front ones make no sound.	You may be listening to stereo sounds without surround mode.	Press a surround mode button to enable the sound field effect.	18
The center speaker channel makes no sound.	The volume of the center virtual speaker channel may be set to minimum level.	Adjust the volume level of the center virtual speaker channel.	32
The surround speaker channels make no sound.	The volume of the surround virtual speaker channels may be set to minimum level.	Adjust the volume level of the surround virtual speaker channels.	32
The subwoofer makes no sound.	The volume of the subwoofer channel may be set to minimum level.	Adjust the volume level of the subwoofer.	32
Sound is poor (noisy).	A speaker cable may be shorted.	Make sure all cables are connected properly.	11
This system does not operate properly.	This system may receive a strong electrical shock, such as from a lightning bolt or excessive static electricity, or drop in power supply.	Set this system to standby mode, and then disconnect the power cable. Wait for about 30 seconds, connect the power cable, and then turn on this system.	16
	The system control cable may be connected improperly.	Connect the system cable firmly.	11
A digital or high-frequency equipment produces noises.	The system may be placed close to digital equipment or high-frequency equipment.	Place this system farther away from such equipment.	—

Problem	Cause	Solution	See page
The remote control does not operate the system.	The system may be outside the remote control operation range.	For information on the remote control operation range, refer to “Using the remote control”.	7
	The remote control sensor of this system may be exposed to direct sunlight or lighting.	Change the lighting.	—
	The batteries may be worn out.	Replace the batteries.	7

■ Tuner

Problem	Cause	Remedy	See page
FM stereo reception is noisy.	The characteristics of FM stereo broadcasts may cause this problem when the transmitter is too far away, or if the antenna quality is poor.	Check the antenna connections.	14
		Try using a high-quality directional FM antenna.	—
		Use the manual tuning method.	23
There is distortion, and clear reception cannot be obtained, even with a good FM antenna.	There is multi-path interference.	Adjust the antenna position to eliminate multi-path interference.	—
The desired station cannot be tuned into with the automatic tuning method.	The signal is too weak.	Use a high-quality directional FM antenna.	—
		Use the manual tuning method.	23

■ iPod

Note

In case of a transmission error without a status message appearing in the front panel, check the connection to your iPod (P. 14).

Status message	Cause	Remedy	See page
Unknown iPod	The iPod being used is not supported by this system.	Only iPod (Click and Wheel), iPod nano, iPod mini, and iPod touch are supported.	—
iPod connected	Your iPod is properly stationed in the Yamaha iPod universal dock (such as YDS-10 or YDS-11, sold separately) connected to the DOCK terminal of this system, and the connection between your iPod and this system is completed.		
Disconnected	Your iPod was removed from the Yamaha iPod universal dock (such as YDS-10 or YDS-11, sold separately) connected to the DOCK terminal of this system.	Station your iPod back in the Yamaha iPod universal dock (YDS-10 or YDS-11, sold separately) connected to the DOCK terminal of this system.	14, 27

Bluetooth

Note

In case of a transmission error without a status message appearing in the front panel, check your Bluetooth component.

Status message	Cause	Remedy	See page
Searching...	The Yamaha Bluetooth wireless audio receiver (such as YBA-10, sold separately) and the Bluetooth component are in the process of the pairing.		
	The Yamaha Bluetooth wireless audio receiver (such as YBA-10, sold separately) and the Bluetooth component are in the process of establishing the connection.		
Completed	The pairing is completed.		
Canceled	The pairing is canceled.		
Not found	The system cannot find the Bluetooth component while performing the pairing or trying to connect to the Bluetooth component.		
BT connected	The connection between the Yamaha Bluetooth wireless audio receiver (such as YBA-10, sold separately) and the Bluetooth component is established.		
Disconnected	The Bluetooth component is disconnected from the Yamaha Bluetooth wireless audio receiver (such as YBA-10, sold separately).		
Not Available	The pairing is performed when the Yamaha Bluetooth wireless audio receiver (such as YBA-10, sold separately) is connected to the Bluetooth component.		

Glossary

■ AIR SURROUND XTREME

New surround technology developed by Yamaha enables surround sound with fewer speakers. In comparison to traditional front surround technology, the AIR SURROUND XTREME provides a natural surround sound field.

■ Channel (ch)

A channel is an audio type that has been divided based on range and other characteristics.

Ex. 7.1 channel

- Front speakers, Left (1ch), Right (1ch)
- Center speaker (1ch)
- Surround speakers, Left (1ch), Right (1ch)
- Surround back speakers, Left (1ch), Right (1ch)
- Subwoofer (1ch × 0.1* = 0.1ch)

* In contrast to a full 1-channel band, a component designed to enhance low frequency sound for added effect.

■ Dolby Digital

Digital surround sound system which is developed by Dolby Laboratories provides completely independent multi-channel audio. With 3 front channels (left, center, and right) and 2 surround stereo channels, Dolby Digital provides five full-range audio channels. With an additional channel especially for bass effects (called LFE, or low frequency effect), the system has a total of 5.1-channels (LFE is counted as 0.1 channel). By using 2-channel stereo for the surround speakers, more accurate moving sound effects and surround sound environment are possible than with Dolby Surround.

■ Dolby Pro Logic II

It is an improved matrix decoding technology that provides better spatiality and directionality on Dolby Surround programmed material; provides a convincing three-dimensional sound field on conventional stereo music recordings; and is ideally suited to bring the surround experience to automotive sound. While conventional surround programming is fully compatible with Dolby Pro Logic II decoders, soundtracks will be able to be encoded specifically to take full advantage of Pro Logic II playback, including separate left and right surround channels.

■ DTS

Digital surround sound system developed by DTS, Inc., which provides 5.1 channel audio. With an abundance of audio data, it is able to provide authentic-sounding effects.

■ PCM (Pulse Code Modulation)

A signal that is changed to digital format without compression. A CD is recorded with 16-bit sound at 44.1 kHz, while DVD recording is anywhere from 16 bits at 48 kHz to 24 bits at 192 kHz, which makes it a higher quality sound than CD.

■ Sampling frequency

The number of sampling (process for digitalizing analog signals) per second. In principle, the higher the sampling rate, the wider the frequency range that can be played back, and the higher the quantized bit rate, the finer the sound that can be reproduced.

Specifications

YAS-71CU/YAS-81CU

- Type.....2 way acoustic suspension magnetic shielding type
- Driver
 - Woofer..... 8 cm (3") cone magnetic shielding type × 4 (L2, R2)
 - Tweeter.....2.5 cm (1") balanced dome magnetic shielding type × 2 (L1, R1)
- Frequency Response..... 120 Hz to 20 kHz (-10 dB)
- Dimensions (W × H × D)
 - [YAS-71]..... 800 × 105 × 100 mm
(Approx. 31-1/2" × 4-1/8" × 3-15/16")
 - [YAS-81]..... 1,030 × 105 × 100 mm
(Approx. 40-9/16" × 4-1/8" × 3-15/16")
- Weight
 - [YAS-71]..... 5 kg
(Approx. 11 lbs.)
 - [YAS-81]..... 6 kg
(Approx. 13 lbs. 4 oz)

YAS-71SPX/YAS-81SPX

Amplifier

- Minimum RMS output power per channel
 - L/R..... 55 W + 55 W (1 kHz 1% THD + N)
 - Subwoofer 55 W (100 Hz 1% THD + N)
- Maximum power per channel
 - L/R..... 70 W + 70 W (1 kHz 10% THD + N)
 - Subwoofer 70 W (100 Hz 10% THD + N)

FM Tuner

- Tuning range
 - [U.S.A. and Canada models] 87.5 to 107.9 MHz
 - [Other models] 87.5 to 108.0 MHz
- Antenna Input (unbalanced) 75 Ω

Subwoofer

- Type Bass reflex type
- Driver..... 16 cm (6-1/2") cone, Magnetic shielding type
- Frequency Response 35 Hz to 120 Hz (-10 dB)

Other sections

- Power supply
 - [Taiwan model].....AC 110 V, 60 Hz
 - [U.S.A. and Canada models]AC 120 V, 60 Hz
 - [China model]AC 220 V, 50 Hz
 - [Korea model].....AC 220 V, 60 Hz
 - [Asia and Europe models]AC 230 V, 50 Hz
 - [Australia model]AC 240 V, 50 Hz
- Power consumption 50 W
- Standby Power Consumption 1 W or less
- Dimensions (W × H × D) 194 × 450 × 400 mm
(Approx. 7-5/8" × 17-3/4" × 15-3/4")
- Weight 13 kg
(Approx. 28 lbs. 11 oz)

* Specifications are subject to change without notice.



This system employs new technologies and algorithms that make it possible to achieve 7-channel surround sound with only two front speakers, and without using wall reflections.



Manufactured under license from Dolby Laboratories. "Dolby", "Pro Logic" and the double-D symbol are trademarks of Dolby Laboratories.



"DTS" and "DTS Digital Surround" are registered trademarks of DTS, Inc.

