

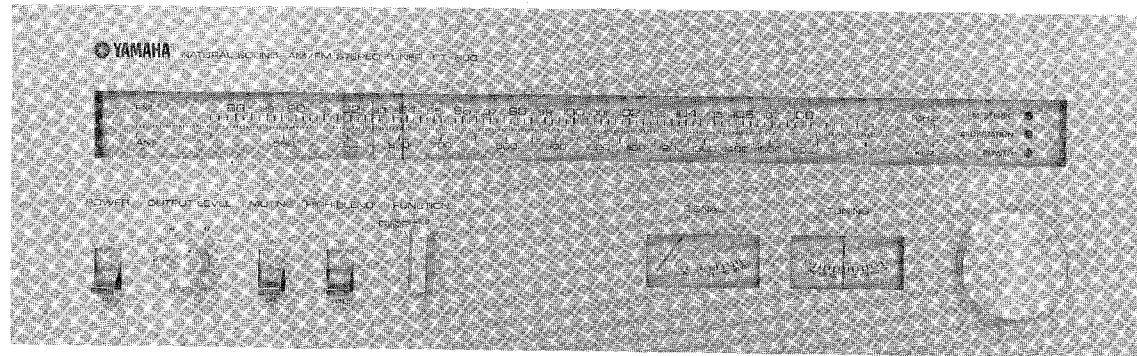

Yamaha Hi-Fi Stereo
FM/AM TUNER
CT-600

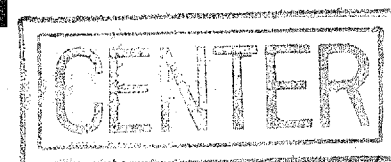

Owner's Manual



CONTENTS

PRECAUTIONS	4
OTHER EQUIPMENT: CONNECTION AND OPERATION	
AM Antenna Connection	5
AM Broadcast Reception	5
FM Antenna Connection	6
FM Broadcast Reception	7
FM Stereo Notes	7
AFC	7
Amplifier Connection	8
Tape Recorder (Deck) Connection	9
Accessories	9
CONNECTION DIAGRAMS	10
FRONT PANEL PARTS AND FUNCTIONS	12
REAR PANEL PARTS AND FUNCTIONS	
Type A Model	14
Type B Model	15
Type C Model	16
Type D Model	17
Type E Model	18
EXPLANATIONS OF CONTROLS AND CONNECTIONS	
Use of the Multipath Terminals	19
TROUBLESHOOTING	20
BLOCK DIAGRAM	21
SPECIFICATIONS	22

PRECAUTIONS

DO'S AND DON'TS

- Do make sure that air can circulate freely above, under and behind the CT-600.
- Do protect the cabinet finish from insecticides, paint thinner and other volatile materials.
- Do protect the set from dampness, dust and mechanical shocks.
- Don't locate the unit in direct sunlight or near a source of heat. Heat can damage transistors.
- Don't force knobs or switches.
- Don't plug the CT-600 power cord into an AC outlet unless you are sure the power switch is off.
- Don't connect any other equipment (amplifier, tape deck, etc.) unless the power switch is off.
- Don't turn on the power switch unless you are sure that the set is connected to an amplifier and the amplifier volume is turned down to minimum.

PLEASE READ THIS FIRST

You may seriously damage any transistorized audio unit by being careless when you first operate it. Carelessness is the major cause of audio repairs. Avoid disappointment by following the precautions listed here BEFORE you attempt to plug in or operate your CT-600.

If your set has a voltage selector, before you plug in the power cord check that the selector is set to your local current.

If not properly set, turn the knob and reset it to the correct position.

Voltage settings: 110, 130, 220, 240V (the 150, 260V settings are not connected).

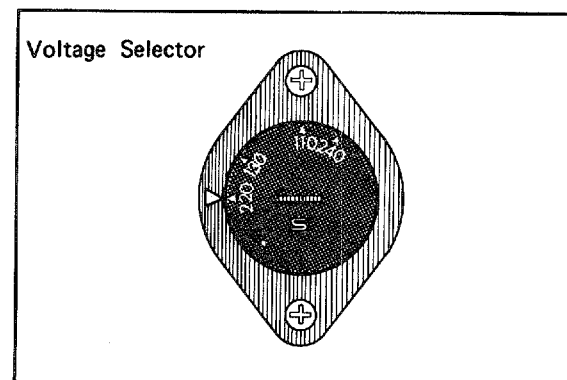

OTHER EQUIPMENT: CONNECTION AND OPERATION

AM ANTENNA CONNECTION

A first-quality AM ferrite bar antenna is built into the rear panel. Beginning AM reception should be done using this antenna only; tune in a strong station and then swing out the bar while watching the signal meter to find the best angle (see Fig. 1).

Inside a ferroconcrete building or in a weak signal area where this antenna alone does not provide sufficient signal strength, an outdoor AM antenna must be installed. Connect it to the AM antenna terminal and set it up as shown in Fig. 2. Be sure to ground the set with the ground terminal next to the AM terminal at this time.

AM BROADCAST RECEPTION

Set the Function selector to AM and tune across the dial for the desired station. As you approach the station watch the signal meter for maximum deflection to the right (the tuning meter does not function for AM). Tuning to this point will provide the best reception.

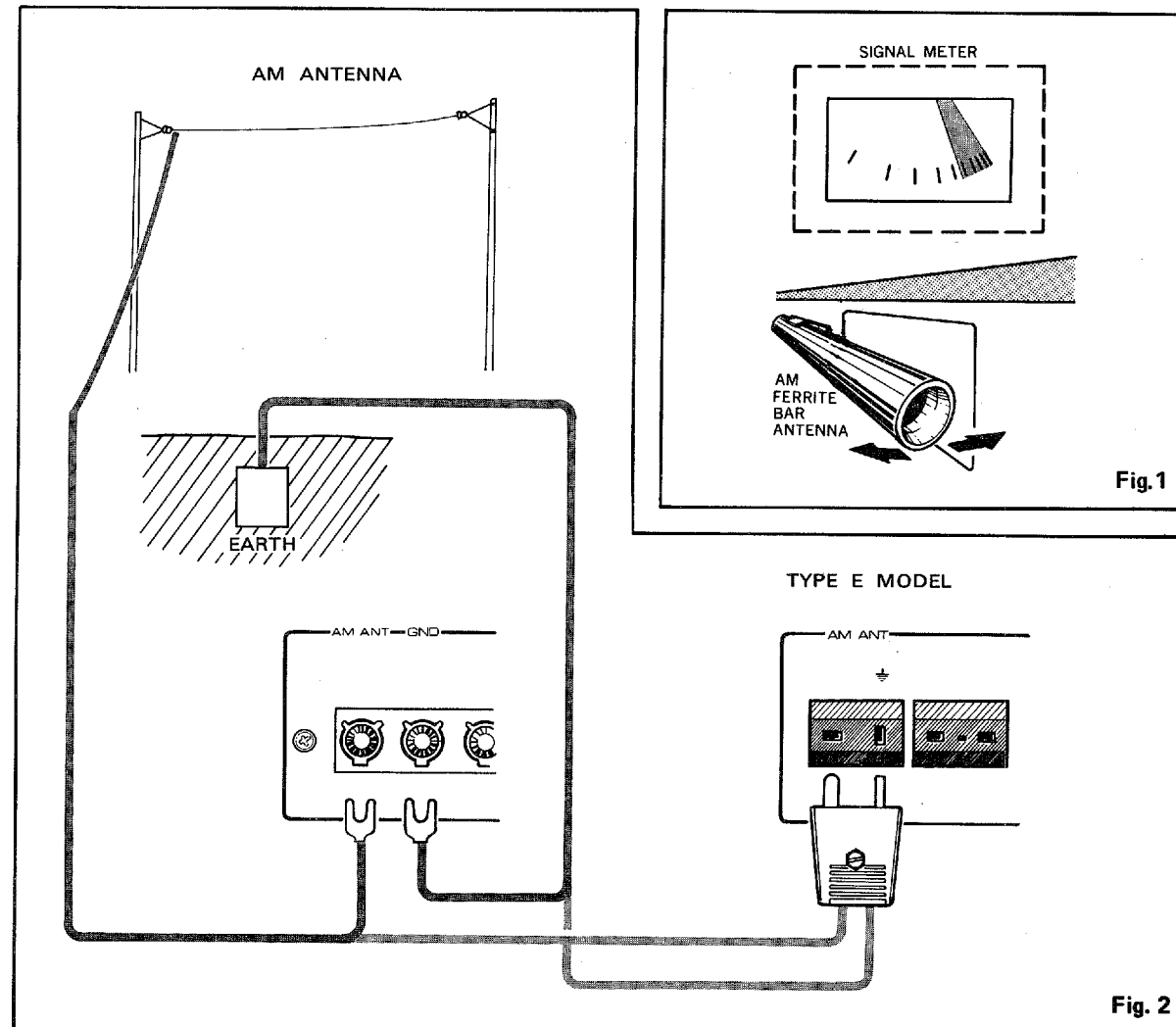

FM ANTENNA CONNECTION

A T-shaped FM ribbon antenna is included among the accessories. Use it in strong signal areas (near the FM broadcast stations). For optimum FM (and especially FM stereo) reception install a special outdoor FM antenna.

There are two types of FM antenna terminals on the CT-600: 300Ω and 75Ω.

To use the ribbon antenna, connect to the 300Ω terminals as shown in Fig. 3. Tack the antenna up on a wall while watching the signal meter for maximum needle deflection as you try different antenna locations (see Fig. 4).

If you use an outdoor antenna, select a location as far as possible from sources of interference (motor-cycle ignition noise, etc.). Between the antenna and the CT-600 use a coaxial cable with a thickness up to C2V. Connect to one of the 75Ω terminals. If the cable has a connector on the end, use the threaded connector terminal (on the far right side of the antenna terminal panel). If there is no connector, strip the end of the cable so that the core lead can be connected to the terminal, with the outer shield sheathing bared to make contact as the cable is installed under the clamp. Use the 75Ω terminal with the clamp (see Fig. 5).

In some cases the outdoor antenna will require a matching transformer (300Ω : 75Ω), while some antenna do not; be sure to carefully read the antenna owner's manual. If you cannot use a coaxial cable for the antenna, but must use a regular feeder line (like that for television antennas), connect it directly to the 300Ω terminals.

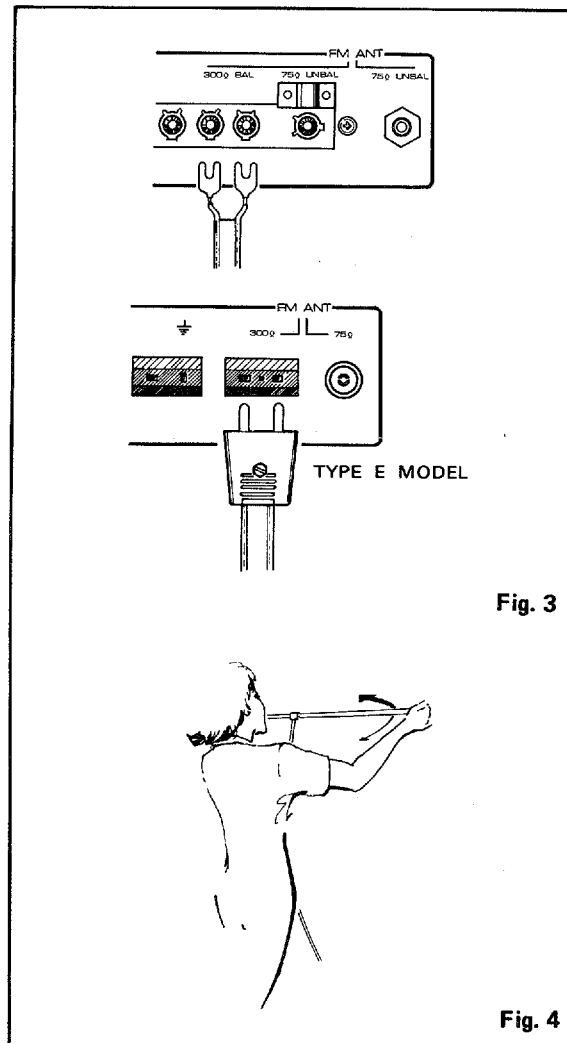

Fig. 3

Fig. 4

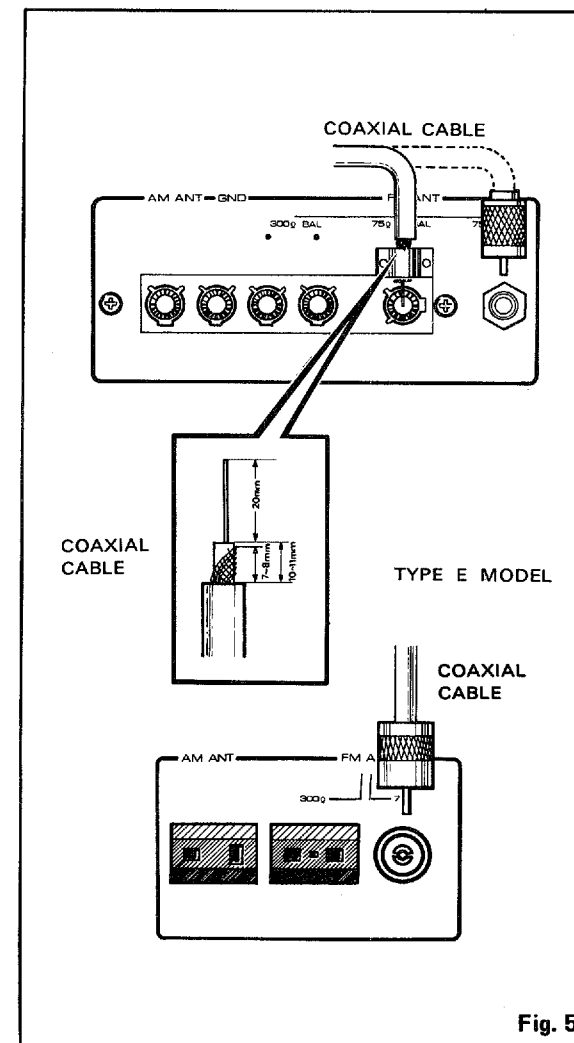

Fig. 5

FM BROADCAST RECEPTION

Set the Function selector to FM Auto and tune to the desired station. As with AM listening, watch the signal meter for maximum deflect on, but final tuning should then be done by watching the tuning meter so that its needle is centered (see Fig. 6). If there is a great deal of noise between stations it can be reduced while tuning by switching on the Muting switch. In weak signal area, however, there is a danger that the muting effect will also cut out particularly feeble signals. For this reason, do not use it when tuning in a weak station, or in a weak signal area. When it is used, however, be sure to reset to OFF the Muting switch once the station is tuned in.

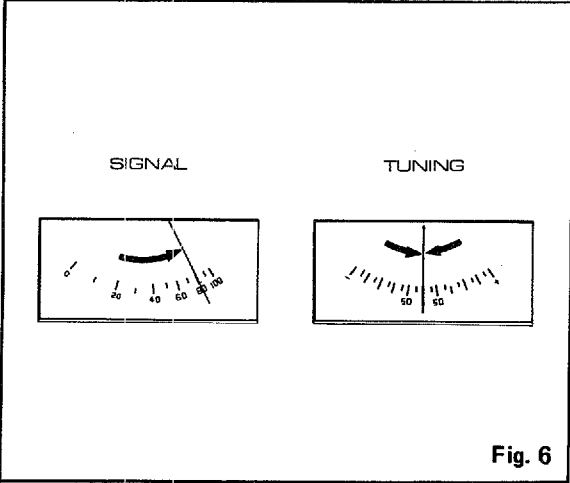

Fig. 6

● FM STEREO NOTES

When a stereo broadcast is received, the stereo indicator lamp lights up and the set automatically functions in stereo. If the lamp flickers or goes out altogether, it indicates that the signal is too weak for sufficient stereo channel separation. In this case switch the Function selector to FM Mono. The stereo effect will be cancelled, but the signal will become noticeably clearer (see Fig. 7). If this problem occurs with the ribbon antenna, it may be cured by installing an outdoor antenna.

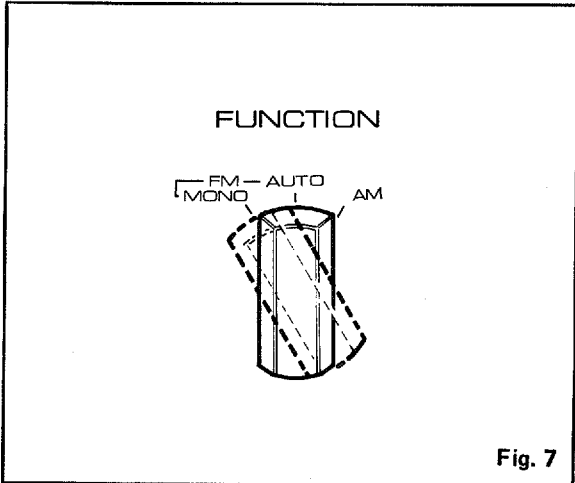

Fig. 7

● AFC

When you touch the tuning knob a special Yamaha circuit goes into operation shutting off the AFC (its indicator lamp dims). Then, once the station is tuned in and you release the knob, the AFC automatically comes back on (and so does the lamp) to lock onto the station for drift-free reception (see Fig. 8).

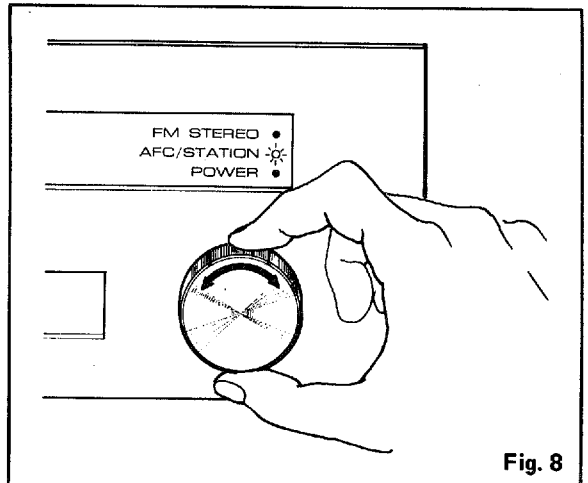

Fig. 8

AMPLIFIER CONNECTION

Connect the CT-600 to a pre-amp or pre-main amp. Use the connector cords included among the accessories to connect the Variable Output jacks on the CT-600 rear panel to the amplifier Tuner or Aux input jacks (see Fig. 9). Be sure to connect left to left and right to right.

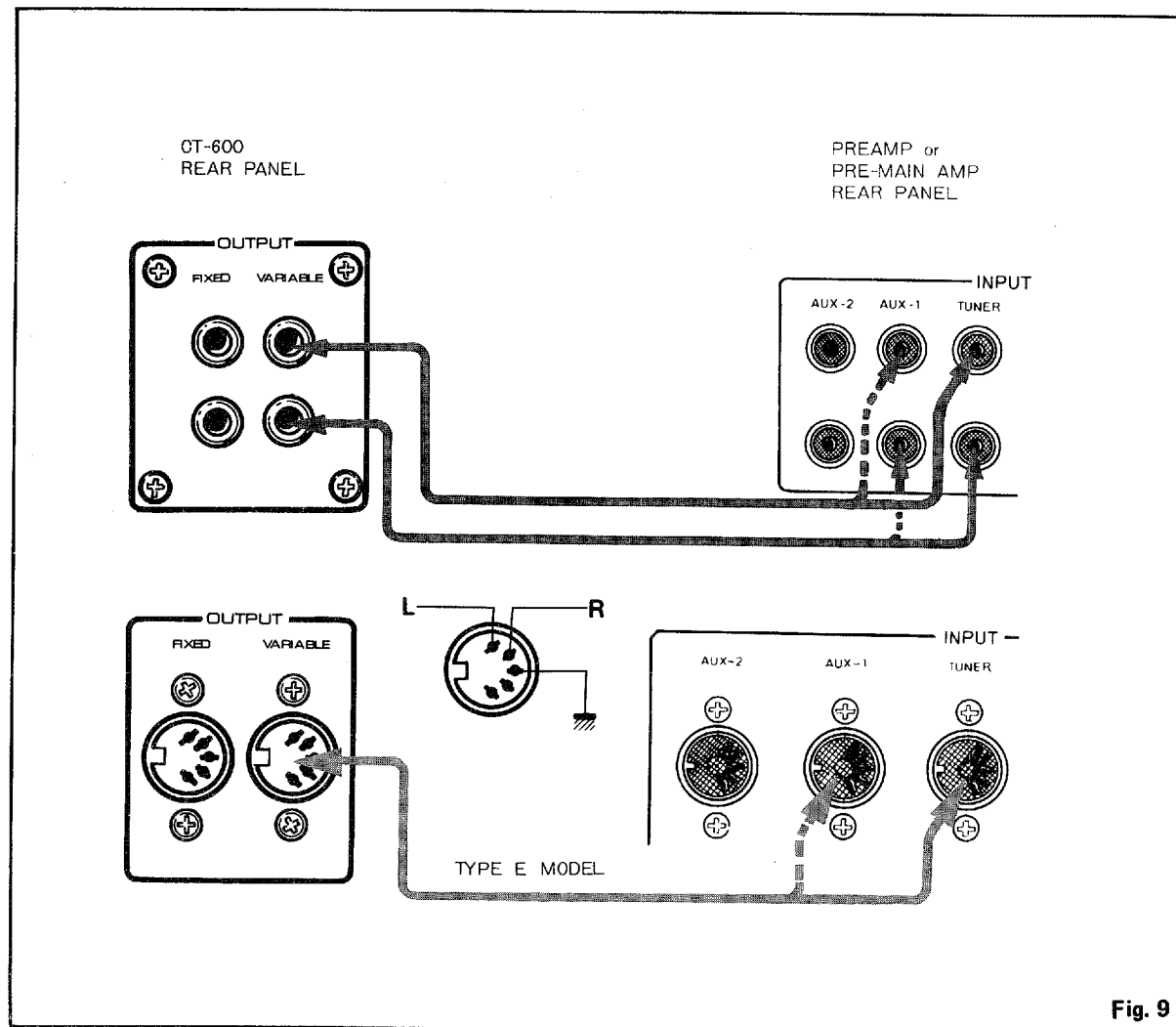

Fig. 9

TAPE RECORDER (DECK) CONNECTION

The CT-600 can be connected directly to a tape recorder or deck for recording. In this case connect the CT-600 Fixed Output jacks to the tape deck or recorder input jacks, being careful not to mistake left and right channels (see Fig. 10)

Note: In this case the output level cannot be controlled; adjust the recording level with the recorder input controls.

ACCESSORIES

- Service Pads

Use the service pads to protect the upper panel of the CT-600 when another unit is placed on it. Peel off the tape and stick a pad to each foot of the other unit before placing it on top of the CT-600.

- Hexagonal Wrench

Use this wrench to loosen the Function selector if its settings do not match the markings on the panel (see Fig. 11).

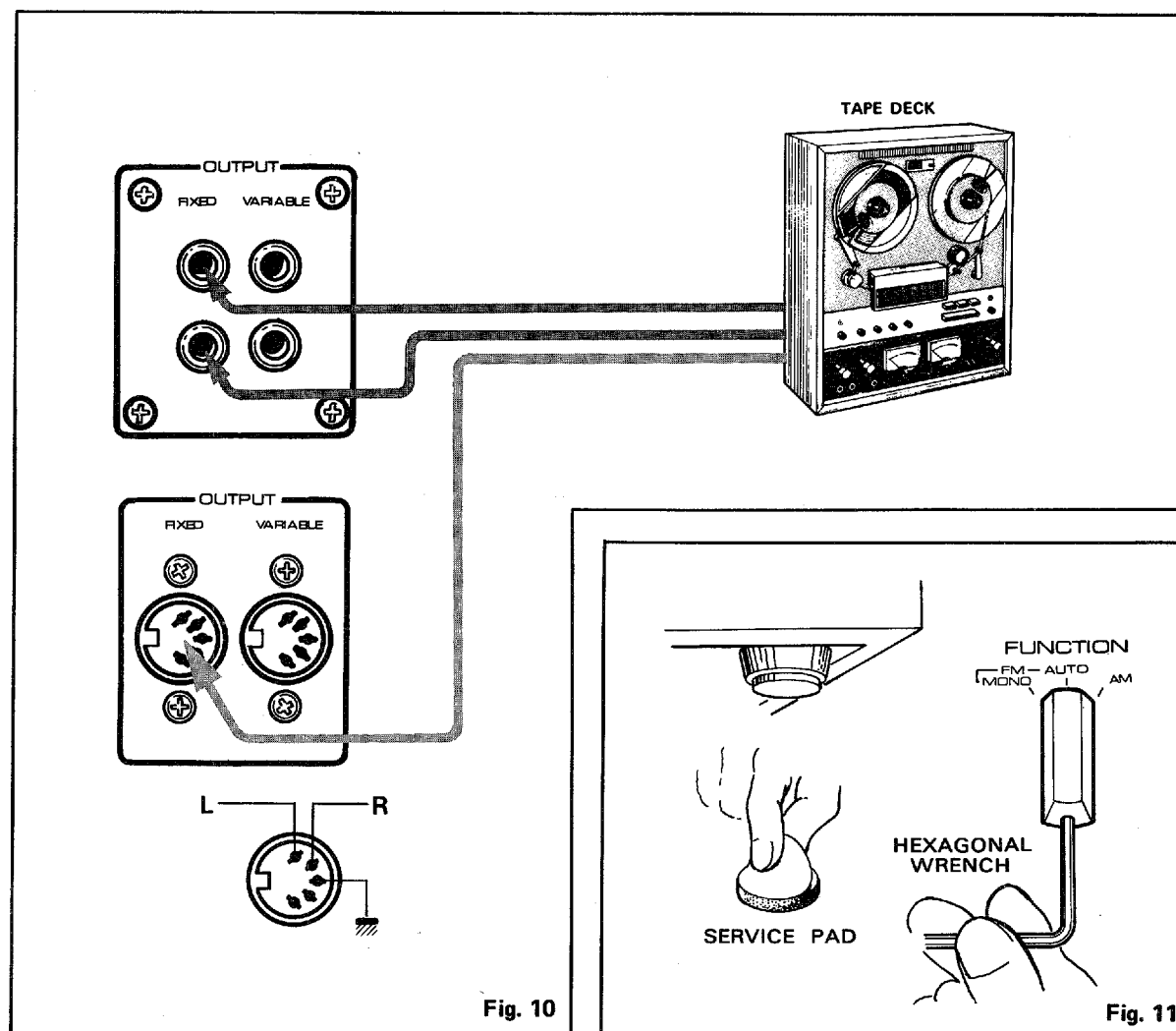
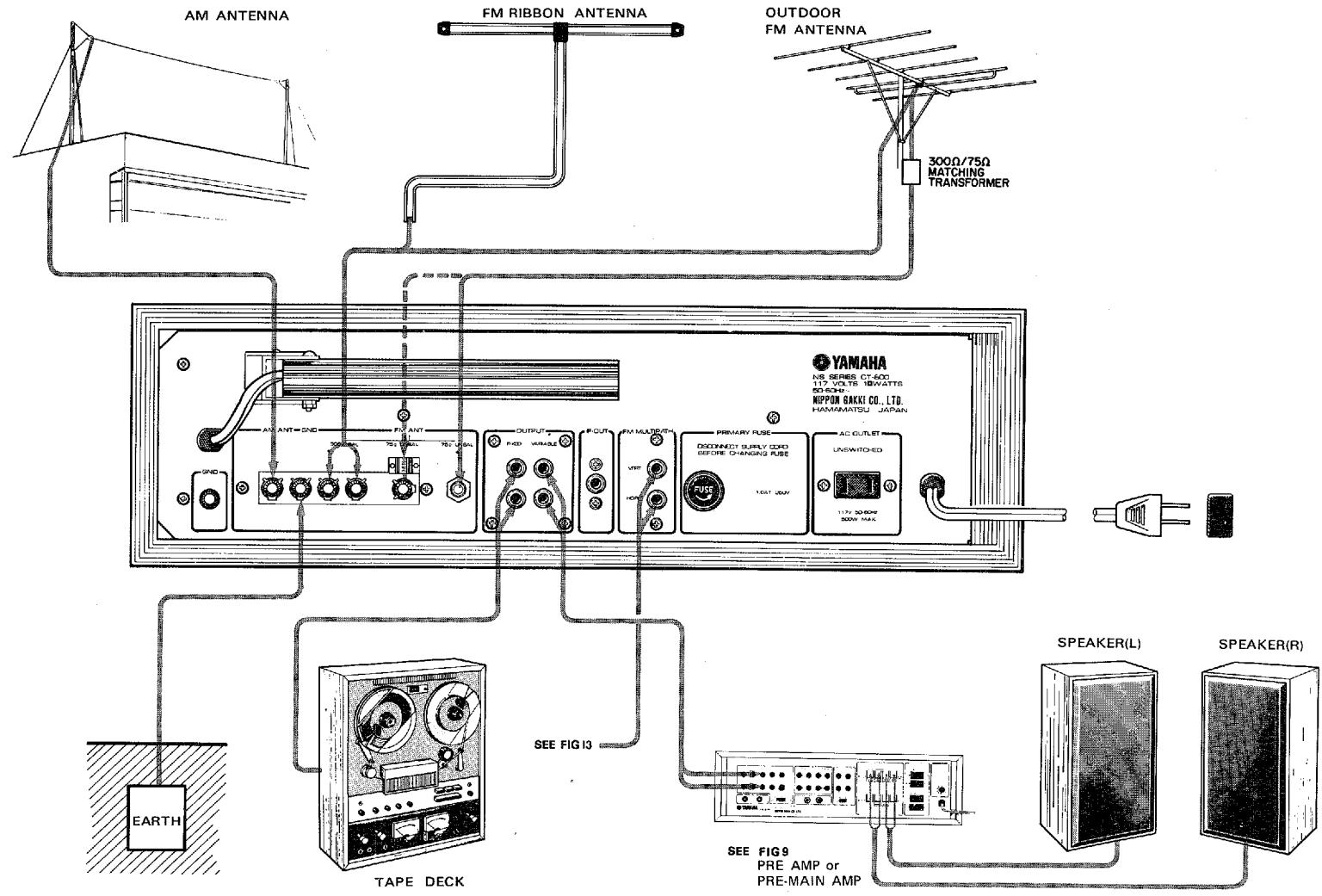

Fig. 10

Fig. 11

CONNECTION DIAGRAMS

• FOR REAR PANEL TYPE A, B, C, D MODELS



• FOR REAR PANEL TYPE E MODEL

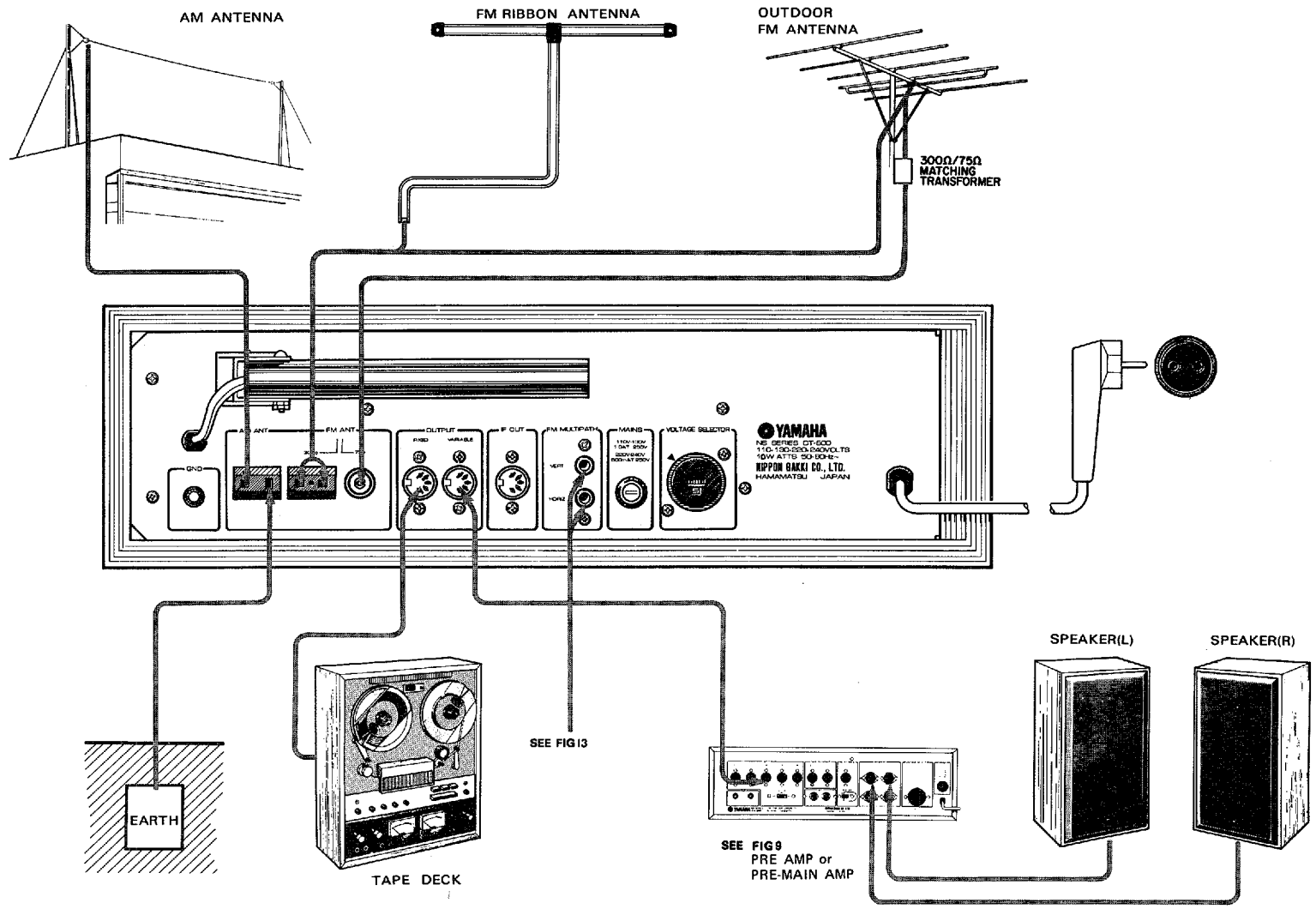

FRONT PANEL PARTS AND FUNCTIONS

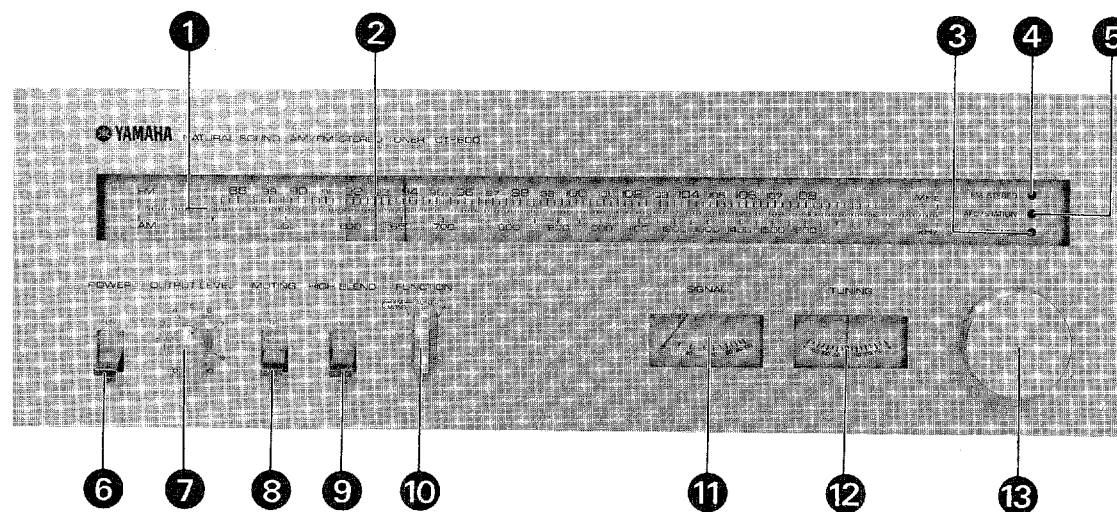

① DIAL SCALE

Shows the frequency of the incoming signal. The upper portion is for FM, the lower for AM.

② DIAL INDICATOR

Moves when the Tuning knob is turned. The middle red line indicates the frequency of the AM or FM setting.

③ POWER INDICATOR

Lights when the unit is receiving power and the switch is on.

④ FM STEREO INDICATOR

When an FM stereo program is received the set will automatically switch to stereo performance and this lamp will light. When a monophonic

station is tuned, the set will play in mono and this lamp will go out.

⑤ AFC/STATION INDICATOR

During normal reception this lamp is lit. When a station is being tuned and your hand is on the tuning knob, the AFC goes off automatically, and this lamp dims (this permits more precise

tuning). Then, when you remove your hand the AFC goes on and the lamp lights (AFC locks on to the station for drift-free reception) If the signal is very weak, however, the lamp may fail to light.

⑥ POWER SWITCH

Use it to switch on the CT-600.

⑦ OUTPUT LEVEL CONTROL

Adjusts the level of output signal strength. Affects only the signals passing through connector cords plugged into the Variable jacks on the rear panel. This control is ideal for matching the CT-600 output to those of other units, such as a tape deck, record player, etc.

⑧ MUTING SWITCH

This switch turns on the muting circuit which cancels noise between FM stations while tuning (see p. 19).

⑨ HIGH BLEND SWITCH

With this switch on, high-frequency noise will be cut from FM stereo signals. If there is no noise problem, leave this switch off.

⑩ FUNCTION SELECTOR

This switch lets you select AM or FM reception.

FM Mono: Set to this position only when you are receiving an FM stereo signal which contains an intolerable amount of noise. The noise will be cut somewhat, although the stereo effect will be lost.

FM Auto: For normal FM listening. In this position the set will automatically switch from mono to stereo mode and back, according to the signal received.

AM: For all AM broadcast reception.

⑪ SIGNAL METER

Shows the strength of the AM or FM signal being received. The farther the needle deflects to the right, the stronger the signal.

⑫ TUNING METER

Works for FM only. When the tuning is near the station, this meter needle deflects to show how far off, and in which direction, the tuning is. Tune for exact needle centering.

⑬ TUNING KNOB

REAR PANEL PARTS AND FUNCTIONS

• TYPE A MODEL

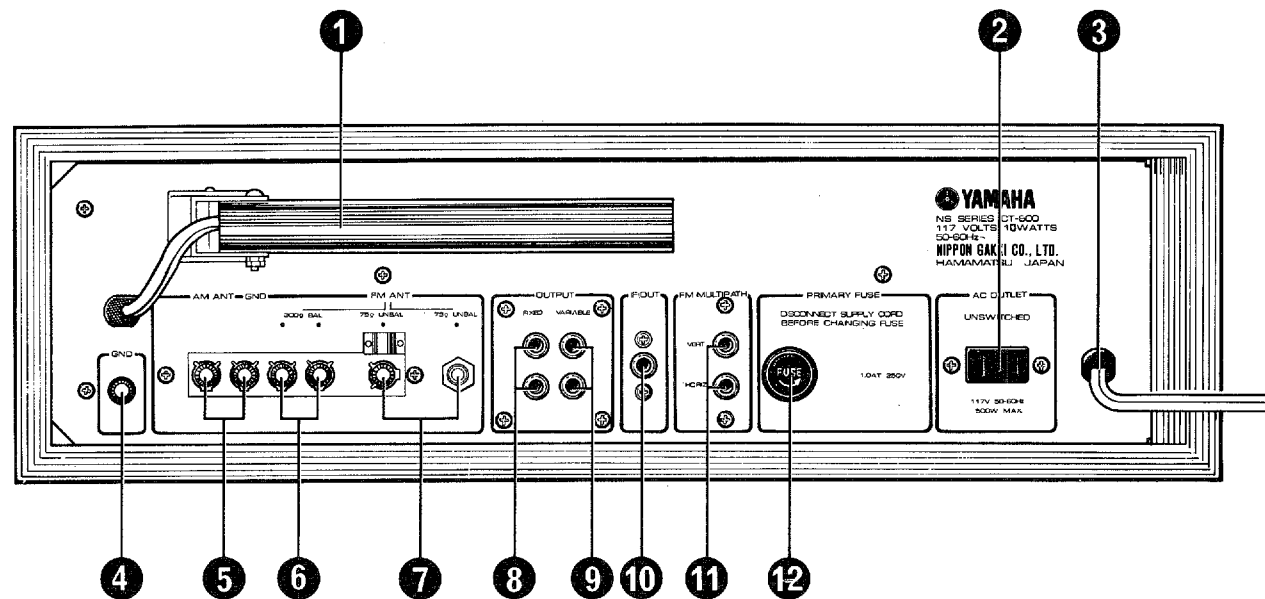

① AM FERRITE BAR ANTENNA

② AC OUTLET

This outlet is unswitched; in other words it provides AC power as long as the CT-600 is plugged in, regardless of the power switch setting. Ideal for powering a tape deck or turntable.

③ POWER CORD

④ GROUND TERMINAL

⑤ AM ANTENNA TERMINAL

⑥ FM ANTENNA TERMINALS (300Ω)

⑦ FM ANTENNA TERMINALS (75Ω)

⑧ FIXED OUTPUT JACKS

⑨ VARIABLE OUTPUT JACKS

⑩ IF OUT JACK

Use this jack for connecting an FM 4-channel adaptor.

⑪ FM MULTIPATH JACKS

Use these jacks when connecting to an oscilloscope, for precise antenna location and other uses.

⑫ PRIMARY FUSE

Always disconnect the power cord before checking or replacing the fuse. Replace only with a fuse of the same specifications.

• TYPE B MODEL

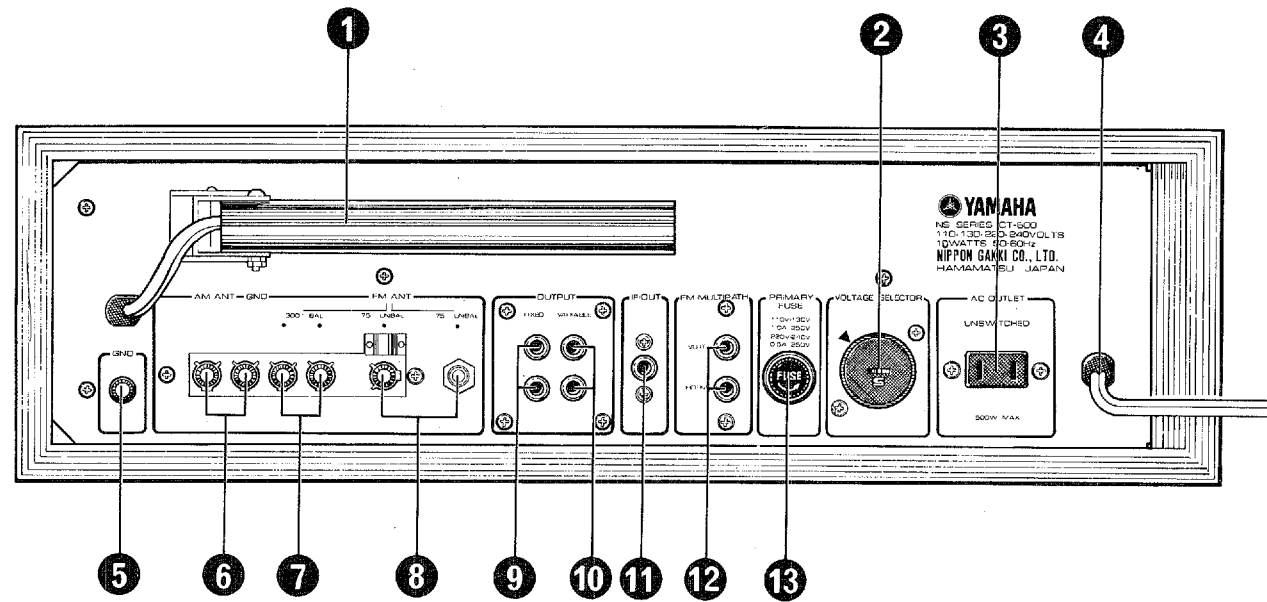

- ① AM FERRITE BAR ANTENNA
- ② VOLTAGE SELECTOR
- ③ AC OUTLET
- ④ POWER CORD
- ⑤ GROUND TERMINAL
- ⑥ AM ANTENNA TERMINAL
- ⑦ FM ANTENNA TERMINAL (300Ω)

- ⑧ FM ANTENNA TERMINAL (75Ω)
- ⑨ FIXED OUTPUT JACKS
- ⑩ VARIABLE OUTPUT JACKS
- ⑪ IF OUT JACK
- ⑫ FM MULTIPATH JACKS
- ⑬ PRIMARY FUSE

● TYPE C MODEL

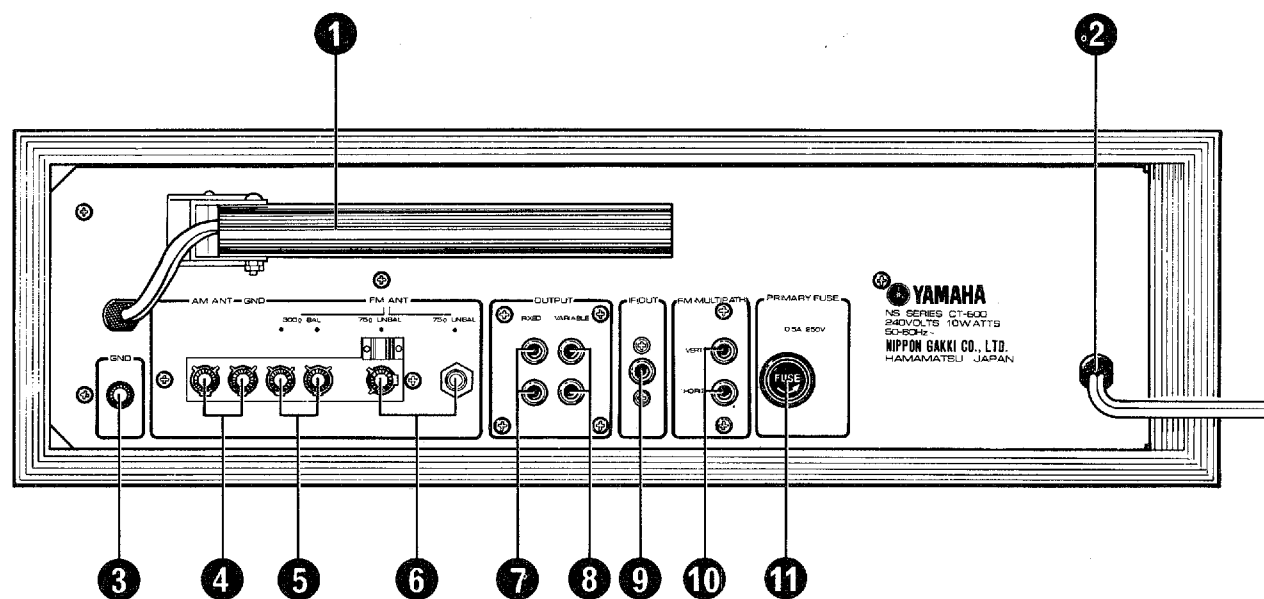

- ① AM FERRITE BAR ANTENNA
- ② POWER CORD
- ③ GROUND TERMINAL
- ④ AM ANTENNA TERMINAL
- ⑤ FM ANTENNA TERMINAL (300Ω)
- ⑥ FM ANTENNA TERMINALS (75Ω)

- ⑦ FIXED OUTPUT JACKS
- ⑧ VARIABLE OUTPUT JACKS
- ⑨ IF OUT JACK
- ⑩ FM MULTIPATH JACKS
- ⑪ PRIMARY FUSE

● TYPE D MODEL

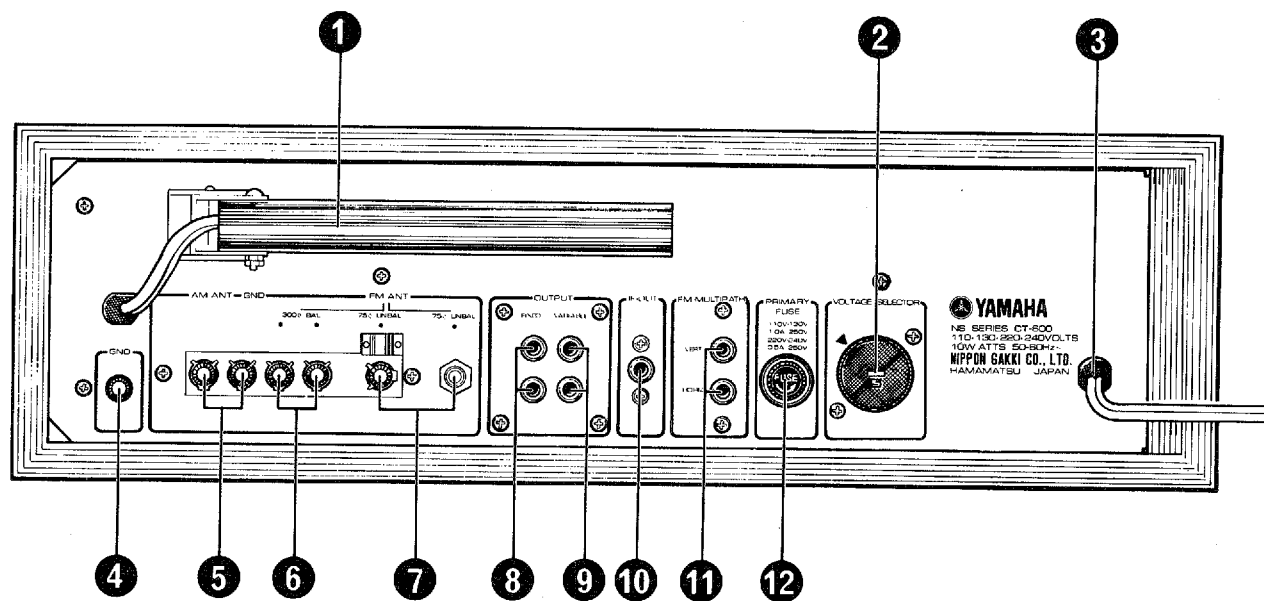

- ① AM FERRITE BAR ANTENNA
- ② VOLTAGE SELECTOR
- ③ POWER CORD
- ④ GROUND TERMINAL
- ⑤ AM ANTENNA TERMINAL
- ⑥ FM ANTENNA TERMINALS (300Ω)

- ⑦ FM ANTENNA TERMINALS (75Ω)
- ⑧ FIXED OUTPUT JACKS
- ⑨ VARIABLE OUTPUT JACKS
- ⑩ IF OUT JACK
- ⑪ FM MULTIPATH JACKS
- ⑫ PRIMARY FUSE

● TYPE E MODEL

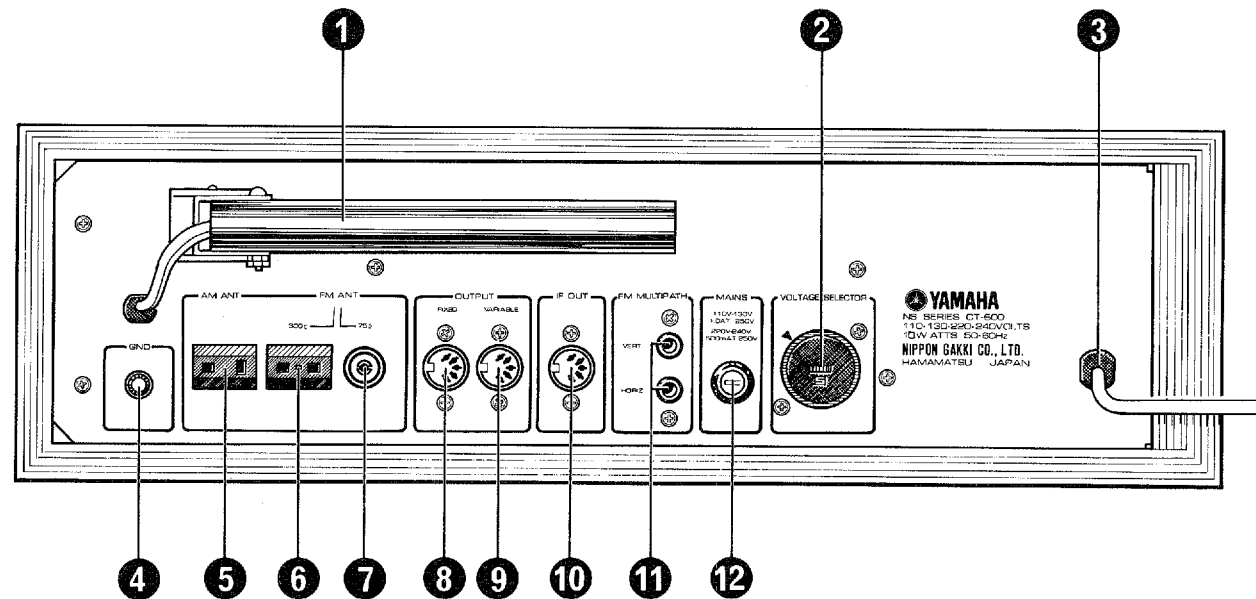

- ① AM FERRITE BAR ANTENNA
- ② VOLTAGE SELECTOR
- ③ POWER CORD
- ④ GROUND TERMINAL
- ⑤ AM ANTENNA CONNECTOR
- ⑥ FM ANTENNA CONNECTOR (300Ω)

- ⑦ FM ANTENNA CONNECTOR (75Ω)
- ⑧ FIXED OUTPUT CONNECTOR
- ⑨ VARIABLE OUTPUT CONNECTOR
- ⑩ IF OUT CONNECTOR
- ⑪ FM MULTIPATH JACKS
- ⑫ PRIMARY FUSE

USE OF THE MULTIPATH TERMINALS

The signal from the broadcast station enters the CT-600 antenna directly on the one hand, but also after bouncing off mountains and buildings, on the other. These reflected signals, coming in from different angles, are called "multipath," and because they are delayed a bit actually interfere with the main signal. This has a particularly adverse affect upon FM stereo channel separation (see Fig. 12).

Precision antenna location and aiming can go far toward reducing multipath reception, especially when done with the aid of an oscilloscope. In this case, the oscilloscope should be connected to the special Multipath terminals provided on the rear panel (see Fig. 13).

Even if an oscilloscope is not available, more or less precise antenna direction can be established by connecting a tester or level meter to the Multipath Vert jack and then experimenting with various antenna positions.

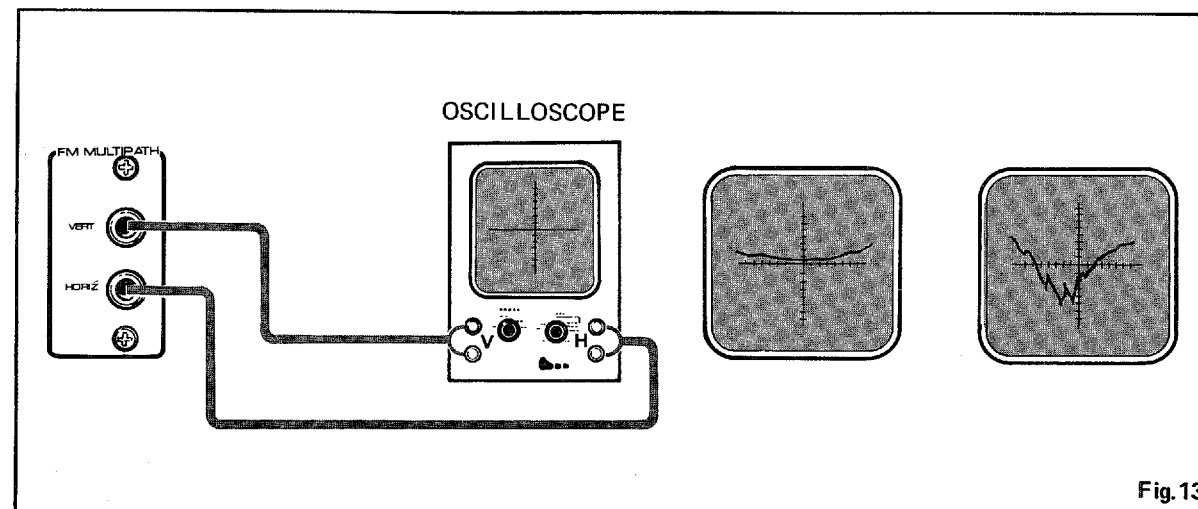
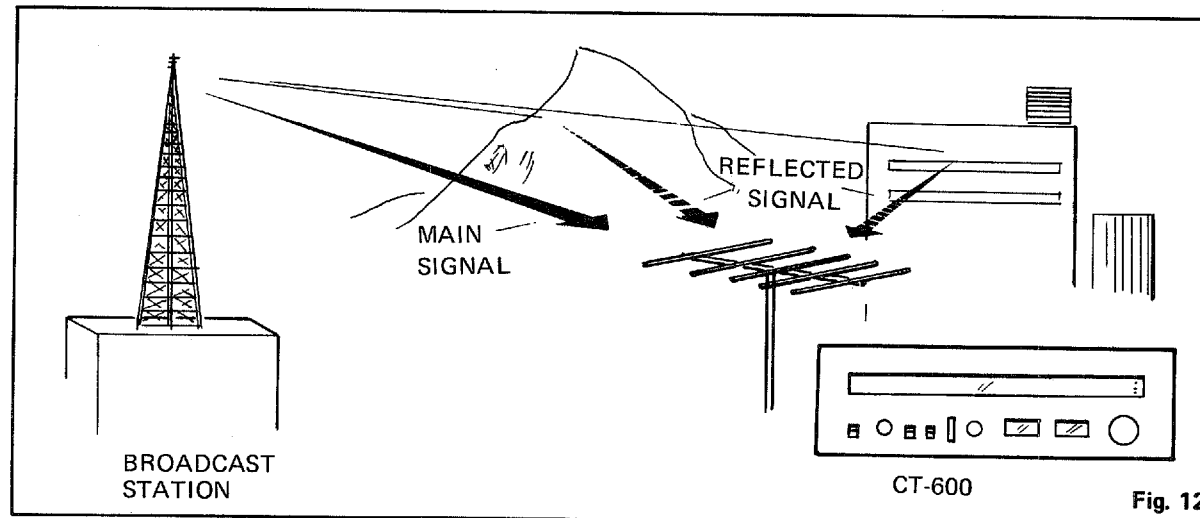

TROUBLESHOOTING

- If your CT-600 does not seem to be functioning properly, consult the following chart and make the proper checks. If it still does not work right, contact your Yamaha dealer.

PROBLEM	CAUSE	CORRECTION
No power when the switch is turned on.	Cord not plugged in. Plug not firmly inserted. Primary fuse blown.	Plug in. Push in firmly. Replace with fuse or contact serviceman.
Power is on, but no sound.	Improper amplifier connection. Output level too low. Improper tuning.	Recheck connections. Turn up or adjust amplifier volume. Retune.
No sound from one channel.	Improper connection. Improper left-right balance setting.	Recheck connections. Readjust on amplifier
FM Stereo indicator flashes during FM stereo reception.	Improper tuning. Improper antenna or weak signal.	Retune. Check antenna connections. Replace ribbon antenna with more powerful outdoor type
Noise during FM stereo reception.	A clear FM stereo signal can be received only to within a distance about half that for an FM mono signal.	Install more powerful antenna. Listen in mono mode
Strange hissing or beeping during FM reception.	Interference from auto or motorcycle ignition.	Make sure to connect antenna with a coaxial cable. Move the antenna farther from the street.

BLOCK DIAGRAM

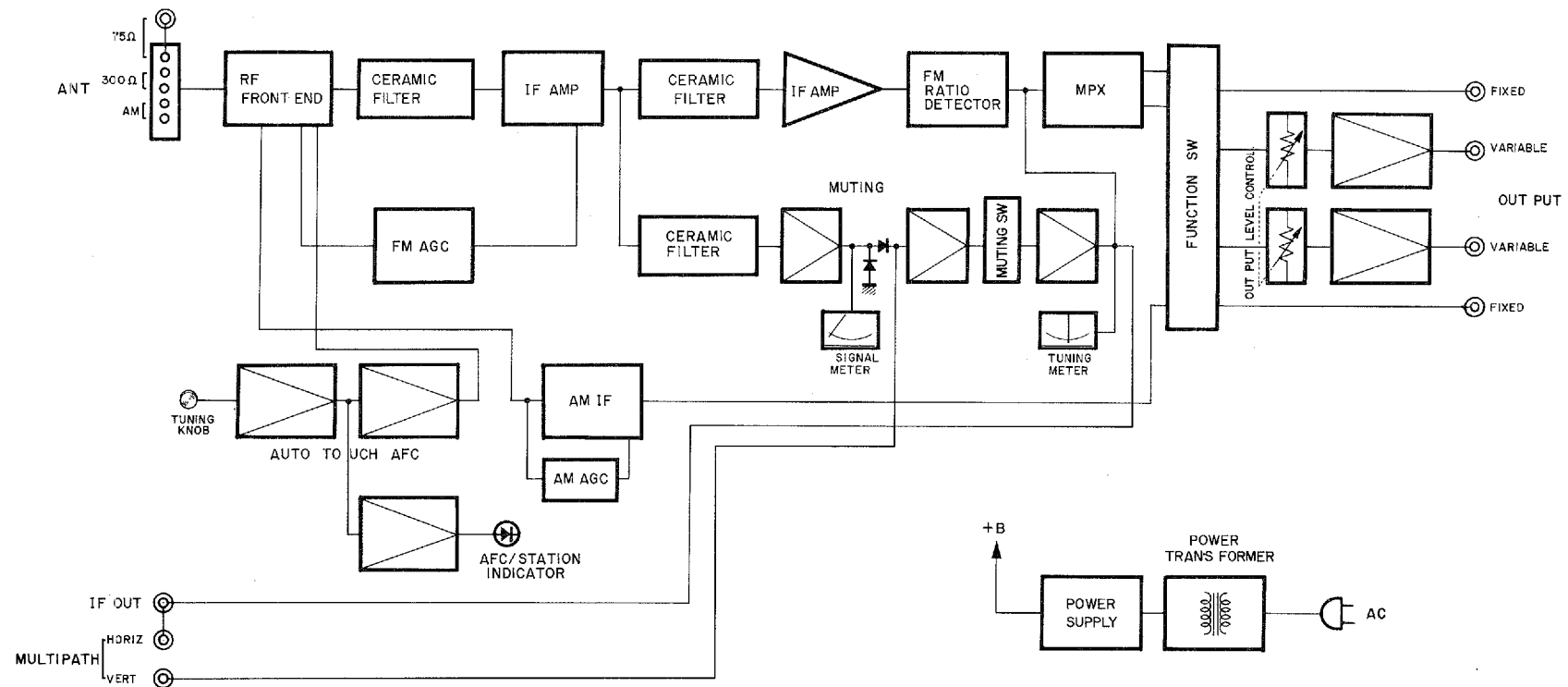

SPECIFICATIONS

● TUNER SECTION

FM:

Tuning Range	88MHz to 108MHz
Sensitivity	
Mono:	IHF/DIN (40kHz Deviation S/N 26dB) 2.0 μ V/1.3 μ V
Stereo:	DIN (40kHz Deviation S/N 46dB DIN #45500) 50 μ V
Quieting Slope	55dB at 5 μ V 60dB at 10 μ V
Limiting Level (-3dB)	1.1 μ V
Image Frequency Rejection	90dB
IF Rejection	95dB
Spurious Response Rejection	95dB
AM Rejection	55dB
Capture Ratio	1.5dB
Selectivity	IHF/DIN (300kHz 40kHz Deviation) 75dB/60dB
Signal-to-Noise Ratio	
Mono:	75kHz Deviation/DIN (40kHz Deviation) 70dB/64dB
Stereo:	75kHz Deviation/DIN (40kHz Deviation) 66dB/60dB
Total Harmonic Distortion (Antenna Level; 1mV)	
Mono:	400Hz (75kHz Deviation)/DIN (1kHz 40kHz Deviation) 0.30/0.30%
Stereo:	400Hz (75kHz Deviation)/DIN (1kHz 40kHz Deviation) 0.50/0.50%
50 to 10,000Hz/DIN (40kHz Deviation)	0.60/0.60%
50 to 10,000Hz/DIN (40kHz Deviation)	2.0/2.0%

Stereo Separation

400Hz (75kHz Deviation)/ DIN (1kHz 40kHz Deviation)
40dB/40dB
50 to 10,000Hz (75kHz Deviation)/ DIN (40kHz Deviation)
28dB/28dB

Frequency Response

50 to 10,000Hz	+1.0dB, -1.0dB
20 to 15,000Hz	+1.5dB, -3.0dB

Sub-Carrier Suppression

40dB

Muting Over ride Signal

Level 10 μ V

Stereo Level

10 μ V

AM:

Tuning Range	525 to 1,605kHz
Sensitivity	52dB/m
Selectivity (at 1,000kHz)	30dB
Signal-to-Noise Ratio (at 80dB/m)	45dB
Image Frequency Rejection (at 1,000kHz)	70dB
Total Harmonic Distortion (at 80dB/m)	0.8%

● GENERAL:

Transistors	31
FETs	2
Diodes	20
Zener Diodes	1
ICs	2
Power Source	AC 110, 117, 130, 220, 240V, 50/60Hz
Power Consumption	9 Watts
AC Outlets (Unswitched)	1
Dimensions (WxHxD)	436mm (17 $\frac{1}{4}$ ") x 144mm (5 $\frac{1}{2}$ ") x 323mm (12 $\frac{3}{4}$ ")
Weight	7.5kg (16 $\frac{1}{2}$ lbs.)

Specifications subject to change without notice.

SINCE 1887



YAMAHA

NIPPON GAKKI CO., LTD. HAMAMATSU, JAPAN