

YAMAHA CDV-1000

*Natural Sound CD Video Combination Player
Plays All Four Formats CD, CDV and LDs
High Resolution Direct FM Detector
Super-Tracking Tilt Servo Laser Head
Full Remote Control Operation
Sleek, Ergonomical Design*

Thank you for purchasing the YAMAHA CD Video Combination Player CDV-1000.



NTSC



OWNER'S MANUAL



CONTENTS

SAFETY INSTRUCTIONS	1	DISC HANDLING PRECAUTIONS	22
CAUTION	4	DISC PLAY	24
TYPE OF DISCS	5	SEARCH OPERATION	26
BEFORE OPERATION	6	PROGRAM PLAY	29
CONNECTIONS	7	STILL/STEP PLAY	29
LOCATION AND FUNCTION OF		REPEAT PLAY	30
PARTS AND CONTROLS	14	MULTIPLE SPEED PLAY	31
BEFORE OPERATING THE REMOTE		SPECIFICATIONS	32
CONTROL TRANSMITTER	20	TROUBLESHOOTING	33

IMPORTANT

Please record the serial number of your unit in the space below:

Model: CDV-1000
Serial No.: _____

WARNING

TO PREVENT FIRE OR SHOCK HAZARD, DO NOT EXPOSE THIS APPLIANCE TO RAIN OR MOISTURE.

SAFETY INSTRUCTIONS

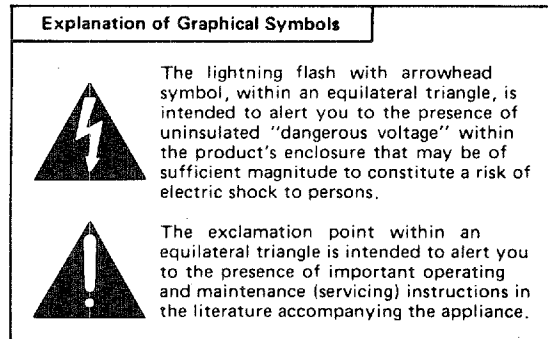
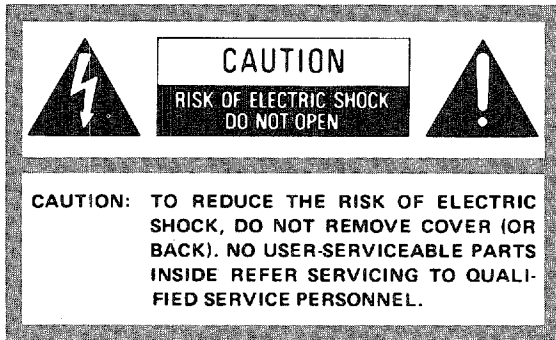

This unit can only be used for NTSC system. For PAL and SECAM system, this unit cannot be used.

- 1 Read Instructions** — All the safety and operating instructions should be read before the appliance is operated.
- 2 Retain Instructions** — The safety and operating instructions should be retained for future reference.
- 3 Heed Warnings** — All warnings on the appliance and in the operating instructions should be adhered to.
- 4 Follow Instructions** — All operating and other instructions should be followed.
- 5 Cleaning** — Unplug this unit from the wall outlet before cleaning. Do not use liquid cleaners or aerosol cleaners. Use a damp cloth for cleaning.
- 6 Attachments** — Do not use attachments not recommended as they may cause hazards.
- 7 Water and moisture** — Do not use this unit near water — for example, near a bath tub, wash bowl, kitchen sink, or laundry tub, in a wet basement, or near a swimming pool, and the like.
- 8 Accessories** — Do not place this unit on an unstable cart, stand, tripod, bracket, or table.
- 9 Ventilation** — The appliance should be situated so that its location or position does not interfere with its proper ventilation. For example, the appliance should not be situated on a bed, sofa, rug, or similar surface that may block the ventilation openings; or placed in a built-in installation, such as a bookcase or cabinet that may impede the flow of air through the ventilation openings.
- 10 Power Sources** — The appliance should be connected to a power supply only of the type described in operating instructions or as marked on the appliance.
- 11 Polarization** — This unit is equipped with a polarized alternating-current line plug (a plug having one blade wider than the other). This plug will fit into the power outlet only one way. This is a safety feature. If you are unable to insert the plug fully into the outlet, try reversing the plug. If the plug should still fail to fit, contact your electrician to replace your obsolete outlet. Do not defeat the safety purpose of the polarized plug.

12 Power-Code Protection — Power supply cords should be routed so that they are not likely to be walked on or pinched by items placed upon or against them, paying particular attention to cords at plugs, convenience receptacles, and the point where they exit from the appliance.

13 Lightning — For added protection for this unit during a lightning storm, or when it is left unattended and unused for long periods of time, unplug it from the wall outlet and disconnect the antenna or cable system. This will prevent damage to the unit due to lightning and power-line surges.

14 Power Lines — An outside antenna system should be located away from power lines.

15 Overloading — Do not overload wall outlets and extension cords as this can result in a risk of fire or electric shock.

16 Object and Liquid Entry — Never push objects of any kind into this unit through openings. Never spill liquid of any kind on the unit.

17 Servicing — Do not attempt to service this unit yourself as opening or removing covers may expose you to dangerous voltage or other hazards. Refer all servicing to qualified service personnel.

18 Damage Requiring Service — Unplug this unit from the wall outlet and refer servicing to qualified service personnel.

A. When the power supply cord or plug is damaged.

B. If liquid has been spilled, or objects have fallen into the unit.

C. If the unit has been exposed to rain or water.

D. If the unit does not operate normally by following the operating instructions. Adjust only those controls that are covered by the operating instructions as an improper adjustment of other controls may result in damage and will often require service to restore the unit to its normal operation.

E. If the unit has been dropped or the cabinet has been damaged.

F. When the unit exhibits a distinct change in performance — this indicates a need for service.

19 Outdoor Antenna Grounding — If an outside antenna or cable system is connected to the unit, be sure the antenna or cable system is grounded so as to provide some protection against voltage surges and built-up static charges. Section 810 of the National Electrical Code, ANSI/NFPA No. 70-1984, provides information with respect to proper grounding of the mast and supporting structure, grounding of the lead-in wire to an antenna discharge unit, size of grounding conductors, location of antenna-discharge unit, connection to grounding electrodes, and requirements for the grounding electrode.

Note to CATV system installer:

This reminder is provided to call the CATV system installer's attention to Article 820-22 of the NEC in USA (and to the Canadian Electrical Code in Canada) that provides guidelines for proper grounding and, in particular, specifies that the cable ground shall be connected to the grounding system of the building, as close to the point of cable entry as practical.

CAUTION: READ THIS BEFORE OPERATING YOUR UNIT

EXAMPLE OF ANTENNA GROUNDING ACCORDING TO NATIONAL ELECTRICAL CODE INSTRUCTIONS (CONTAINED IN ARTICLE 810 — "RADIO AND TELEVISION EQUIPMENT")

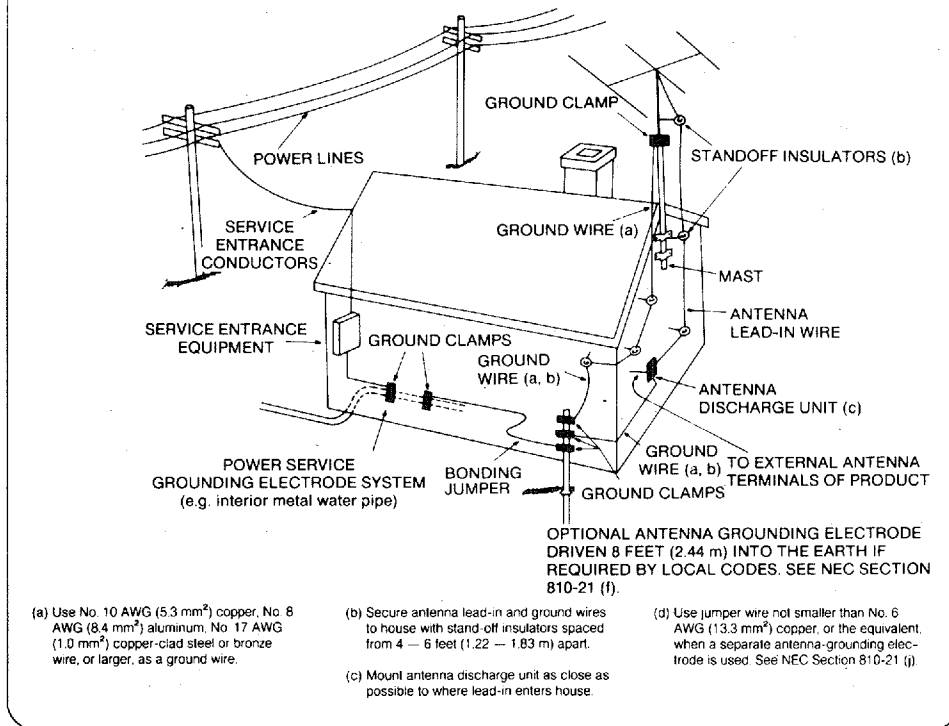

20 Replacement Parts — When replacement parts are required, be sure the service technician has used replacement parts specified by the manufacturer or have the same characteristics as the original part. Unauthorized substitutions may result in fire, electric shock or other hazards.

21 Safety Check — Upon completion of any service or repairs to this video product, ask the service technician to perform safety checks to determine that the video product is in proper operating condition.

1 The CDV-1000 is a sophisticated CD video combination player. To ensure proper operation for the best possible performance, please read this manual carefully.

2 Choose the installation location of your CDV-1000 carefully. Avoid placing it in direct sunlight or close to a source of heat. Also avoid locations subject to vibration and excessive dust, heat, cold or moisture. Keep it away from sources of hum such as transformers or motors.

3 Do not install the player on top of the amplifier or other component and do not place the television set or color monitor on the player.

4 Do not open the cabinet as this might result in damage to the set, or electrical shock. If a foreign object should get into the set, contact your dealer.

5 To prevent lightning damage, pull out the power cord and remove the antenna cable during an electrical storm.

6 When removing the power plug from the wall outlet, always pull directly on the plug; never pull the cord itself.

7 Do not use force when using the switches.

8 When moving the set be sure to first pull out the power plug and remove cords connected to other equipment.

9 Do not attempt to clean the CDV-1000 with chemical solvent as this might damage the finish. Use a clean, dry cloth.

10 Be sure to read the "Troubleshooting" section for advice on common operating errors before concluding that your CDV-1000 is faulty.

11 Keep this manual in a safe place for future reference.

12 This equipment generates and uses radio frequency energy and if not installed and used properly, that is, in strict accordance with the manufacturer's instructions, may cause interference to radio and television reception. It has been type tested and found to comply with the limits for a Class B computing device in accordance with the specifications in Subpart J of Part 15 of FCC Rules, which are designed to provide reasonable protection against such interference in a residential installation.

However, there is no guarantee that interference will not occur in a particular installation. If this equipment does cause interference to radio or television reception, which can be determined by turning the equipment off and on, the user is encouraged to try to correct the interference by one or more of the following measures:

Reorient the receiving antenna

Relocate the CDV-1000 with respect to the receiver

Move the CDV-1000 away from the receiver
Plug the CDV-1000 into a different outlet so that the CDV-1000 and receiver are on different branch circuits.

If necessary, the user should consult the dealer or an experienced radio/television technician for additional suggestions. The user may find the following booklet prepared by the Federal Communications Commission helpful: "How to Identify and Resolve Radio-TV Interference Problems".

This booklet is available from the U.S. Government Printing Office, Washington, DC 20402, Stock No. 004-000-00345-4.

CAUTION

Caution — Use of controls, adjustments, or performance of procedures other than those specified herein, may result in hazardous radiation exposure.

The unit should not be adjusted or repaired by anyone except properly qualified service personnel.

DANGER - Invisible laser radiation when open and interlock failed or defeated.
AVOID DIRECT EXPOSURE TO BEAM. (C007076-1)

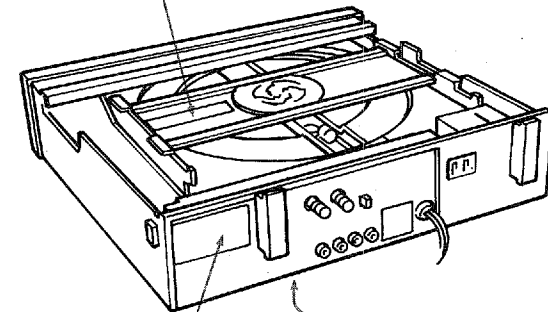

FCC ID: B09SLVCDV1000

YAMAHA
MADE IN JAPAN

This device complies with FCC Rule Part 15. Operation is subject to the following two conditions: (1) This device may not cause harmful interference, and (2) this device must accept any interference that may be received, including interference that may cause undesired operation.

THIS PRODUCT COMPLIES WITH DHS RULES 21 CFR SUBCHAPTER J APPLICABLE AT DATE OF MANUFACTURE.

MANUFACTURED BY
YAMAHA CORPORATION
10-1 NAKAZAWA-CHO,
HAMAMATSU-SHI,
SHIZUOKA-KEN, JAPAN

MANUFACTURED:



(CB66122)

TYPE OF DISCS

■ CD (Compact Audio Disc-Silver Colored 5" Disc)

On a CD, the sound signal is encoded into a series of binary codes and recorded as digital pulses. These pulses are etched on the disc in the shape of pits, with a pitch of 1.6 μm . A laser beam is focused on the pits and the reflected light rays are decoded into a continuous audio waveform.

In a player, a CD rotates at a speed between 500 rpm and 200 rpm, while a laser beam moves from the inner part of the disc to the outer.

■ CDV (Compact Disc Video) SINGLE (gold colored 5" disc)

Uniting both CD and LD (Laservision Disc) disc technologies, up to five minutes of video with digital sound, plus up to 20 additional minutes of digital audio only, can be combined on a conventional CD disc. A gold colored CDV disc rotates at a speed between 2,700 rpm and 1,800 rpm for its video section, and at a speed between 500 rpm and 200 rpm for its audio only section.

LD is abbreviation for Laservision Discs.

■ LD (Laservision Disc) [CAV (Constant Angular Velocity) and CLV (Constant Linear Velocity)]

A 30 cm (12 inch) CAV (standard play) disc rotates at a constant 1800 rpm and a laser beam moves from the inner part of the disc to the outer. A play time of up to 30 minutes is possible on one side of a disc, while up to 54,000 frames can be recorded. With a CAV, play at variable speeds, the frame number, a play mode display, and operations with control instructions are possible.

A 30 cm (12 inch) CLV (extended play) disc rotates at a speed between 1,800 rpm and 600 rpm, with constant linear velocity. A laser beam moves from the inner part of the disc to the outer as with LD (CAV). Playback of up to one hour is possible on one side of the disc, however only normal play and scan operations are possible. The elapsed play time can be displayed on a monitor screen.

DISC IDENTIFICATION CHART

Type of Disc	Size	Capacity	Format
CD — Compact Audio Disc (Silver Disc)	5"	70 Min. Audio	Digital
CDV — Compact Disc Video (Gold Disc)	5"	5 Min. Video 20 Min. Audio	Analog Digital
LD — Laser Disc (CAV/CLV)	8" 12"	40 Min. Video 120 Min. Video	Analog Analog

Track No. (CD, CDV)

On CD or CDV discs, each selection is numbered as a track.

Index No. (CD, CDV)

On some CD or CDV discs, an index number is provided in a selection to divide it into sections, such as "movements" in a symphony.

Chapter No. (LD)

These punctuate disc programs; they correspond to the "chapters" of a book.

* On some discs, chapter numbers are not recorded.

BEFORE OPERATION

Frame No. [LD (CAV)]

Disc programs are continuously paginated frame-by-frame for every picture; this also corresponds to the "pages" of a book.

Time No. [LD (CLV)]

The elapsed time from the beginning of play can be displayed. Some discs have a minimum unit of seconds, while some have minutes.

■ ACCESSORIES

After unpacking, check that the following accessories are contained.

- Remote control transmitter

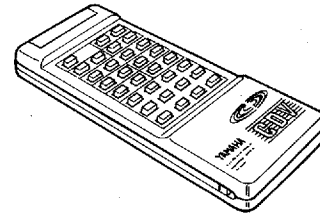

- Coaxial cable with F-type connector

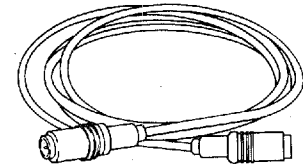

- Batteries

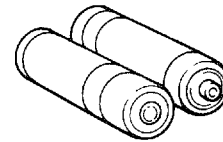

- Audio cord

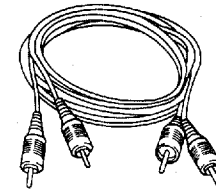

- 75-ohm/300-ohm antenna adapter

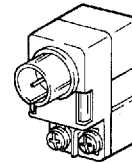

- Video cord

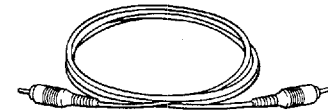

CONNECTIONS

CONNECTION EXAMPLES

- **With a television set and audio system**

With this connection, be sure to set the VHF CHANNEL select switch at the rear to your vacant channel (CH3/L or CH4/H).

- During connection, be sure to disconnect the power cords of this unit and television set from the AC outlet. Do not turn the power on until all connections are completed.

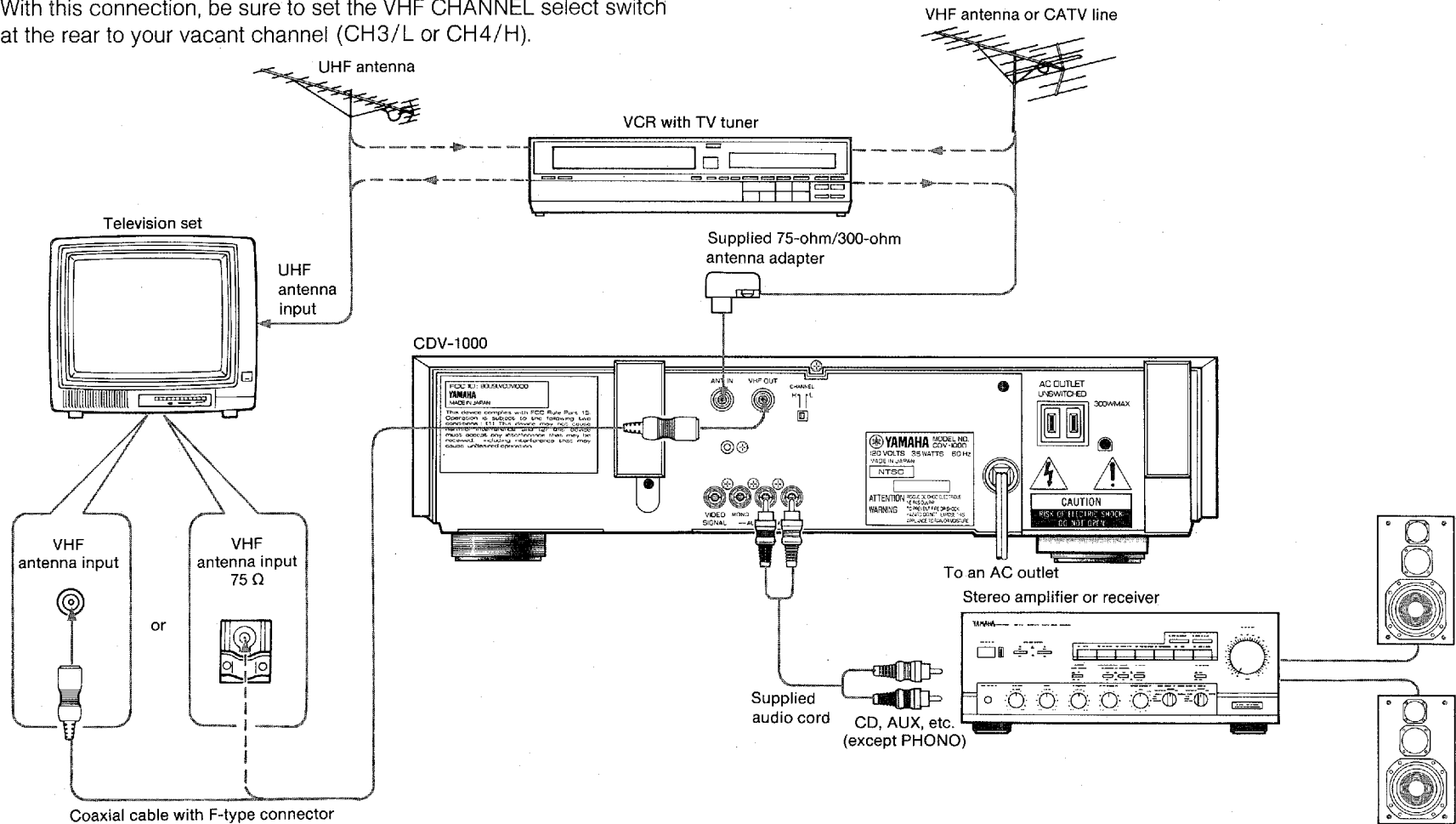

● With a television set having a video input and audio system

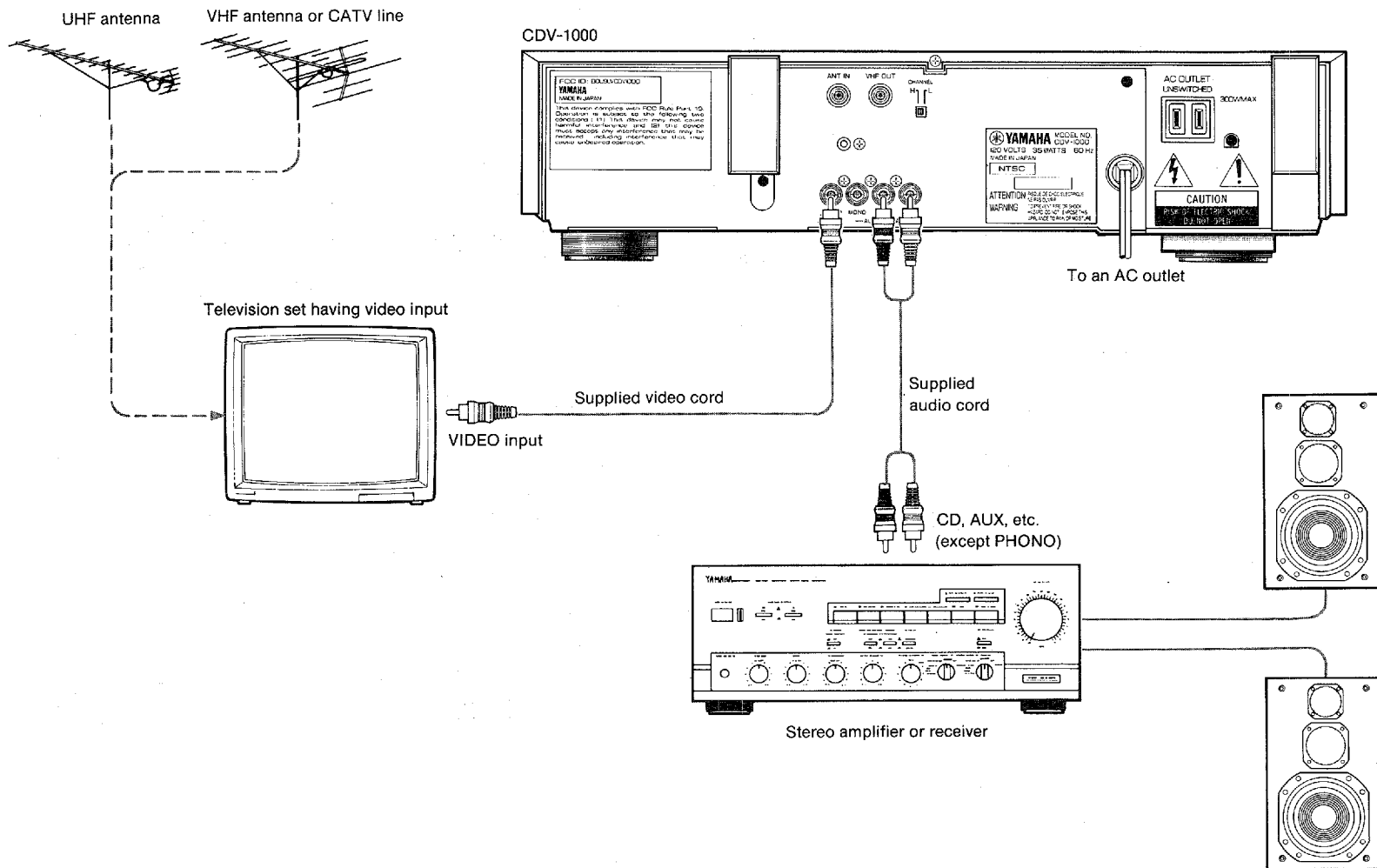

- With a stereo amplifier or receiver having audio and video inputs and television set having video input

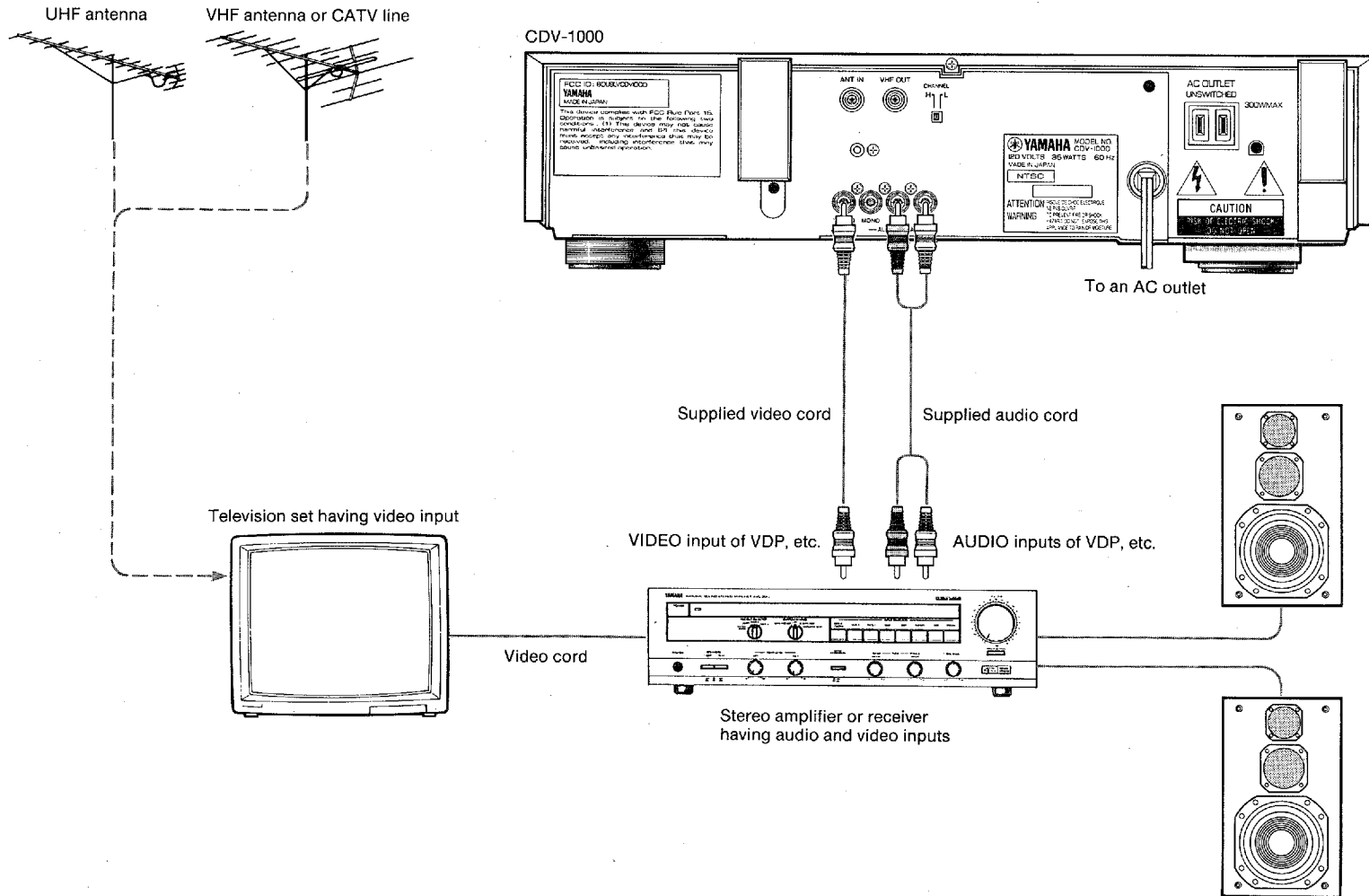

● With a television set having audio and video inputs

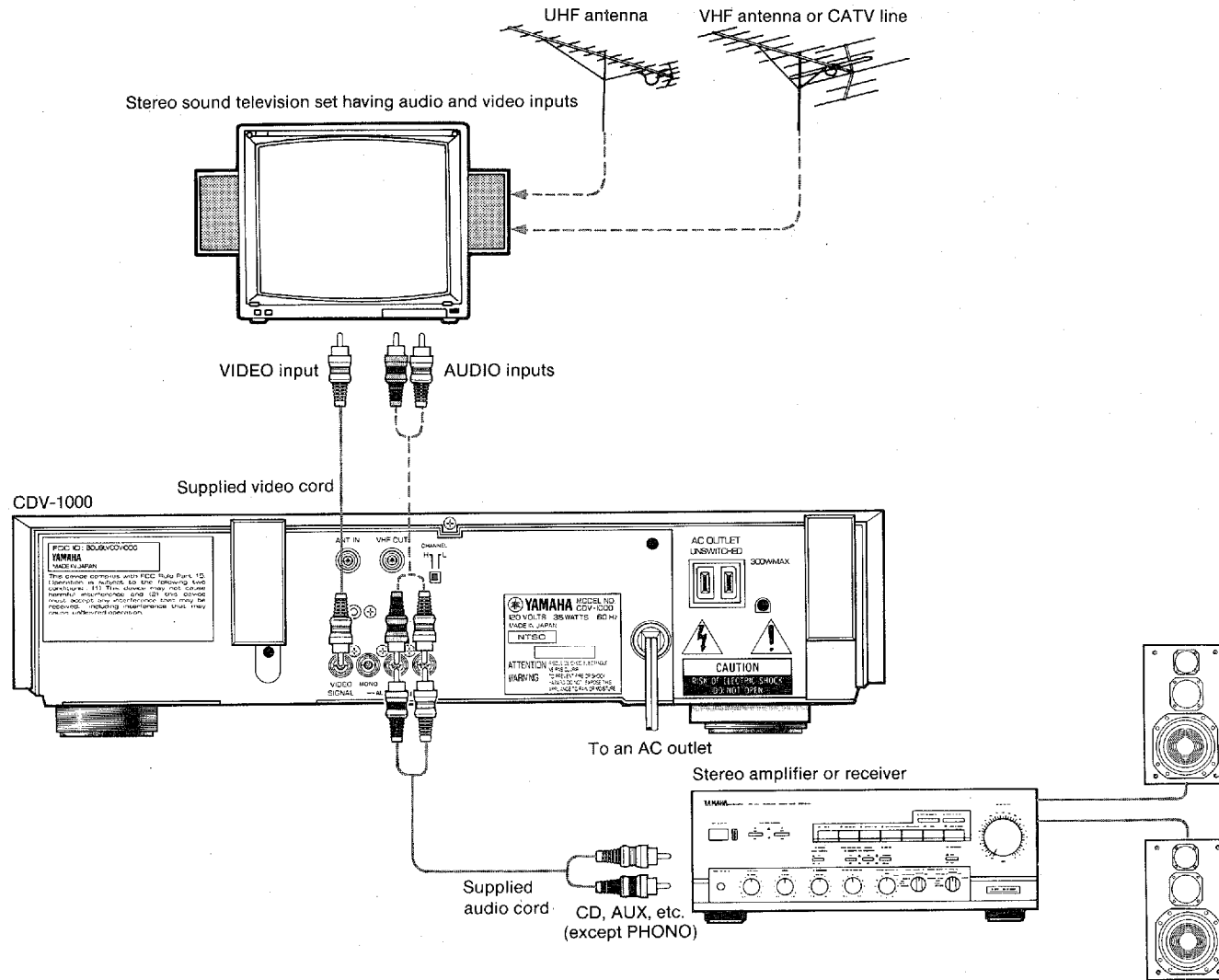

How to connect the supplied coaxial cable with F-type connector to the television set having no F-type antenna terminal

1. Cut off one of the supplied coaxial cable with F-type connector.
2. Process the cut end and connect it to the antenna terminal of the television set as shown below.

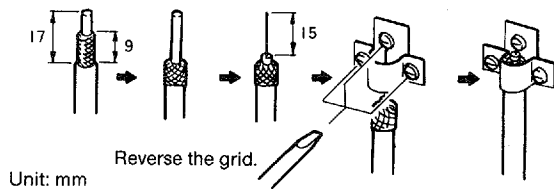

How to use the supplied 75-ohm/300-ohm antenna adapter

1. Remove the cover of the supplied 75-ohm/300-ohm antenna adapter by pressing the locking lugs inward.

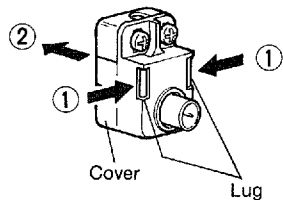

2. Cut the end of the 75-ohm coaxial cable and process it as shown below.

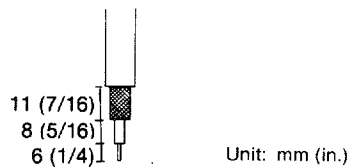

3. Cut off the red lead and remove it.

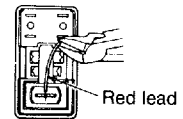

4. Insert the cable wire through the hole as shown below and clamp it with pliers.

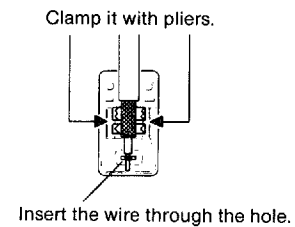

5. Replace the cable end of the cover and snap into place by pressing the adapter together.

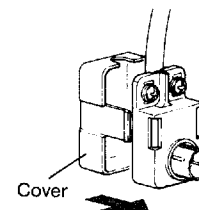

6. Plug the 75-ohm/300-ohm antenna adapter into the ANT IN terminal of this unit.

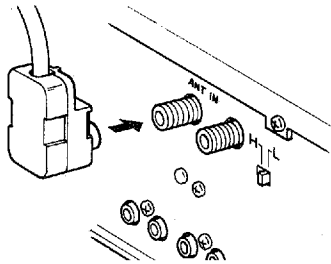

● **When using a 300-ohm feeder**

1. Connect the feeder cable to the terminals of the supplied 75-ohm/300-ohm antenna adapter. At this time, the red lead should be kept connected.

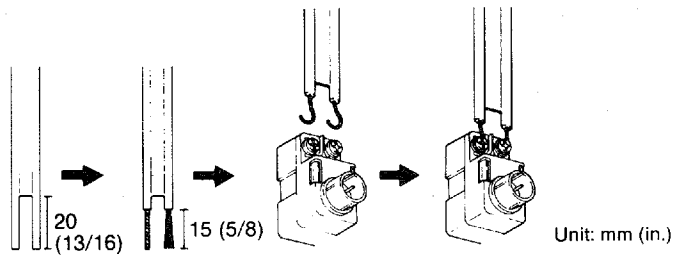

2. Plug the antenna adapter into the ANT IN terminal of this unit firmly.

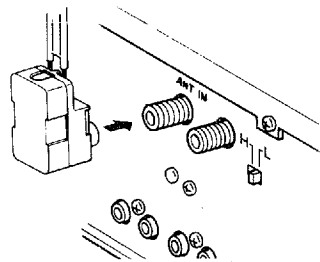

■ **VHF and UHF signals transmission**

When both VHF and UHF signals are transmitted with one cable using a UHF/VHF mixer, a signal splitter is used to separate the signals. In this case, connect the VHF output from the splitter to the ANT IN terminal of this unit and connect the UHF output to the UHF input of the television set. The VHF television broadcasting can be seen by switching the VHF select key of the remote control transmitter.

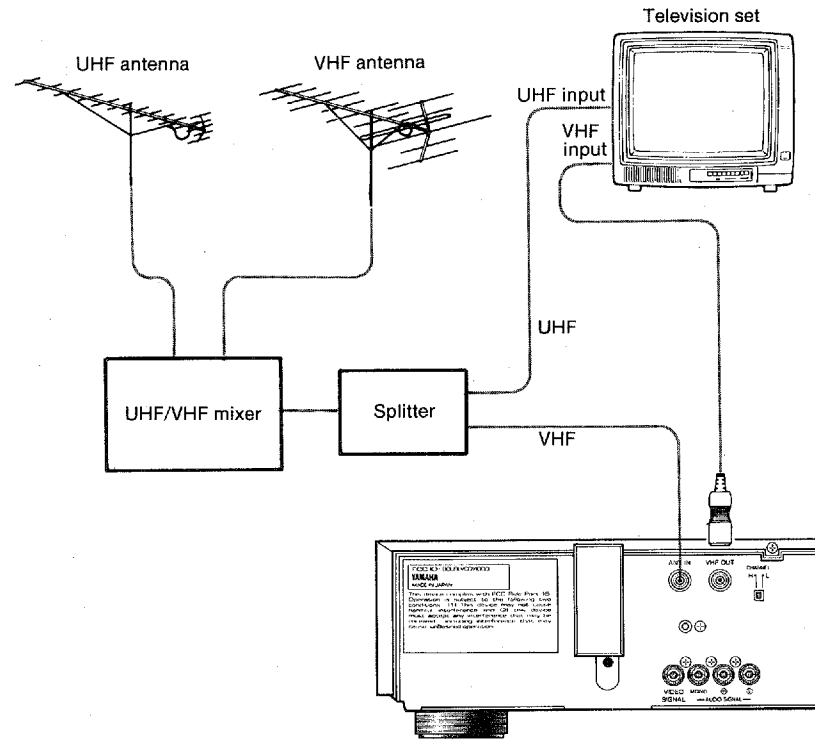

■ **Set the VHF CHANNEL select switch to either channel 3 or 4, whichever is a vacant channel**
(When used with televisions having no video/audio inputs)

In the unit, the video and audio signals are converted to a VHF signal which is the same as the television broadcast signal and output to a vacant channel of your television (channel 3 or 4).

When the channel 3 has no broadcast station in your area, set the VHF CHANNEL select switch to L (right side) position, when channel 4 has no broadcast station in your area, set it to H (left side) position.

■ **Set the television reception channel to 3 or 4**
(When using televisions having no video/audio inputs)

All video signals are converted into VHF channel 3 or 4 signal so that the picture from the disc can be seen on the television screen.

If the picture is not seen clearly, tune to the channel exactly, referring to the instruction manual of television.

* When using with color monitors or stereo systems, turn on the units for this adjustment.

* When using with televisions having audio inputs, set the external input selector of television set to "video".

■ **TO WATCH A TELEVISION BROADCAST**

● **When Using a Television Having No Video/Audio Input Terminals**

- Turn off the player's power.

VHF antenna input signal is connected to the television through this unit.

- Press the VHF select key so that the ANTENNA indicator lights.

VHF antenna input signal is connected to the television through this unit.

* When the ANTENNA indicator is lit as above, the disc rotates in the player while the television broadcast is seen on the screen. When watching the television broadcast for long periods, be sure to turn off the player's power.

● **When Using a Television Having Video/Audio Input Terminals**

1. Take out the disc and turn the player's power off.
2. Set the television to the TV broadcast receiving mode by selecting the desired channel or external input selector.

(For details, refer to the instruction manual of the television being used.)

LOCATION AND FUNCTION OF PARTS AND CONTROLS

FRONT PANEL

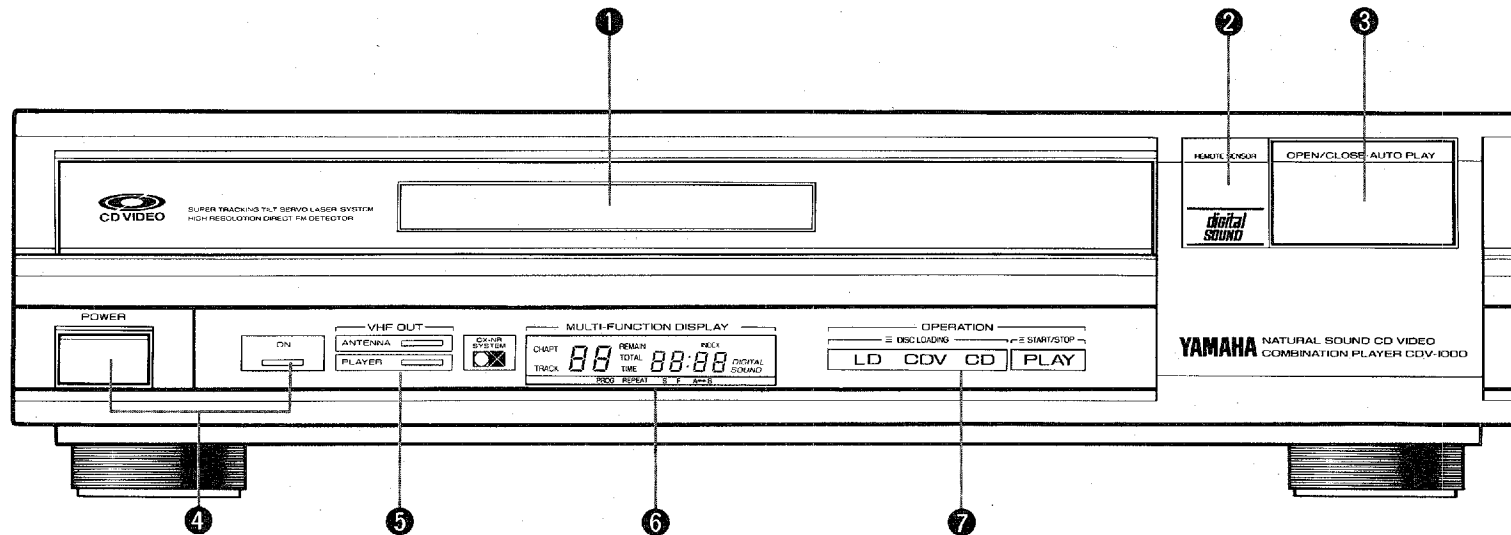

① Disc tray

Load a disc onto this tray.

The tray is opened by pressing the OPEN/CLOSE-AUTO PLAY key of the player or by pressing the OPEN/CLOSE-FULL AUTO PLAY key on the remote control transmitter.

② REMOTE SENSOR

This receives the infrared signal from the remote control transmitter.

③ OPEN/CLOSE-AUTO PLAY key

Press this key to open or close the disc tray.

Pressing this key during play stops the play and opens the disc tray.

The OPERATION indicators flash during opening/closing.

Pressing this key when the disc tray is open and a disc is placed in the tray, closes the tray and starts play.

The PLAY indicator lights while a disc is playing.

④ POWER switch and ON indicator

Press this switch to turn power on and off.
When power is supplied to the unit, the ON indicator lights.

⑤ VHF OUT indicators (ANTENNA/PLAYER)

Indicates the VHF output mode selected with the VHF key on the remote control transmitter.

⑥ MULTI-FUNCTION DISPLAY

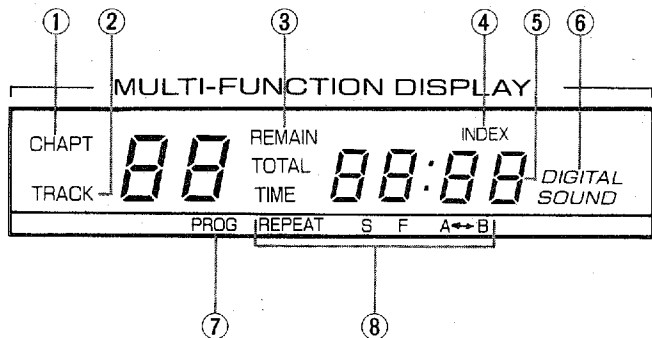

① CHAPT indicator

Indicates the chapter No. of a LD disc.

② TRACK indicator

Indicates the track No. of a CD or CDV disc.

③ REMAIN TIME/TOTAL TIME/TIME display

REMAIN TIME:

Displays the remaining play time of a CD or CDV disc.

TOTAL TIME:

Displays the total play time of a CD or CDV disc.

TIME:

Displays the total play time of the LD disc, or total play time of the CD or CDV selection being played.

④ INDEX indicator

Indicates the index No. of the CD or CDV.

⑤ Numeric display

Displays the time, program No. or index No.

⑥ DIGITAL SOUND Indicator

Lights when the disc being played has a digital sound signal.

⑦ PROG indicator

Lights when programming the selection or during program play.

⑧ REPEAT S/F/A-B indicators

REPEAT S (Single) indicator:

Lights when the REPEAT key on the remote control transmitter is pressed and the unit is set to single repeat mode.

REPEAT F (Full) indicator:

Lights when the REPEAT key on the remote control transmitter is pressed and the unit is set to full repeat mode.

REPEAT A-B indicator:

Lights when the A-B key on the remote control transmitter is pressed and the unit is set to A-B repeat mode.

⑦ OPERATION indicators

LD/CDV/CD indicators:

Indicates the kind of disc that was loaded and flashes while the disc tray is opening or closing.

PLAY indicator:

Lights during play.

REAR PANEL

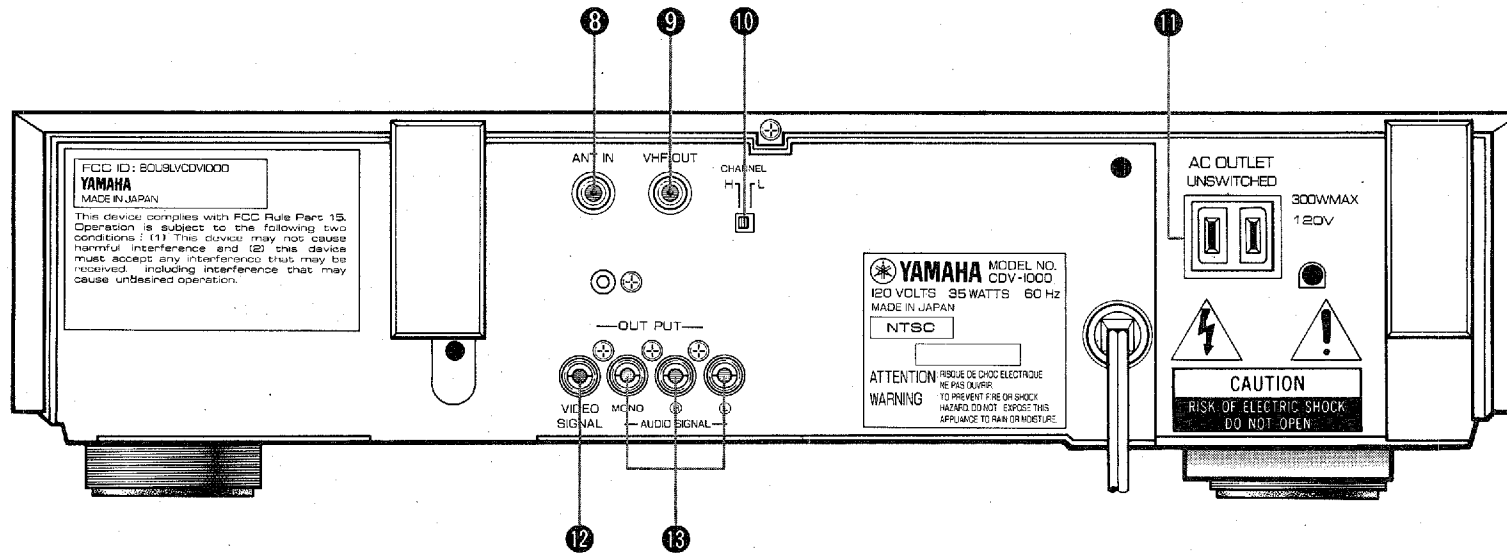

⑧ ANT IN terminal

The broadcast signal from the VHF TV antenna or the VHF signal via VCR is input to this terminal.

When this unit is used with a VCR, connect the VHF output terminal of the VCR to this terminal.

⑨ VHF OUT terminal

This terminal outputs the audio and video signals from the TV broadcast or player which are converted to a VHF signal (channel 3 or 4) by the built-in RF converter.

At this terminal, the audio signal is output in monaural.

⑩ VHF CHANNEL select switch

This switch is for selecting either channel 3 or 4 on your television whichever is not used in your area: channel 3 (L) or channel 4 (H) so that the output signal from the VHF OUT terminal can be received on your television.

⑪ UNSWITCHED AC OUTLET

Connect the power cord of any other audio or video equipment to this outlet. Power is always supplied to this outlet, regardless of the setting of the POWER switch on the CD video combination player.

The maximum power consumption of connected equipment should be less than 300 watts.

12 VIDEO SIGNAL output jack

Outputs the video signal. Connect the video signal from this jack to the VIDEO IN jack of the TV monitor, etc.

13 AUDIO SIGNAL output jacks

MONO output jack:

Outputs the audio signal in monaural. When the television or VCR to be used has a mono audio input jack only, use this jack.

R/L output jacks:

Outputs the audio signal in stereo. When a LD disc contains both analog and digital audio signals, the digital audio signal has priority over the analog signal. When the television or VCR to be used has stereo input jacks, use these jacks.

REMOTE CONTROL TRANSMITTER

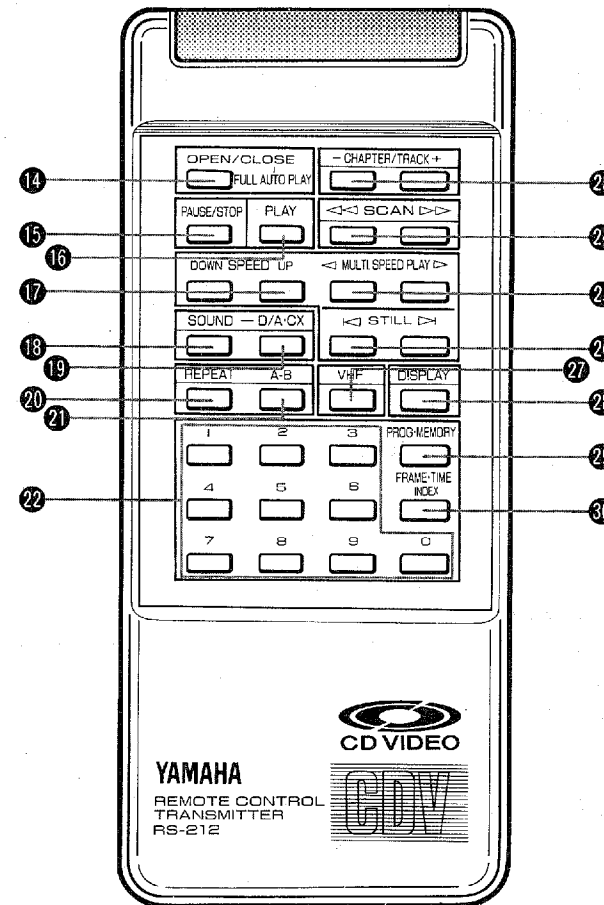

14 OPEN/CLOSE-FULL AUTO PLAY key (CD, CDV, LD)

Press this key to open/close the disc tray. This key has entirely the same function as the OPEN/CLOSE-AUTO PLAY key on the player.

15 PAUSE/STOP key (CD, CDV, LD)

Press this key once to temporarily stop the player operation. When it is pressed again, the player enters the stop mode.

When this key is pressed while the disc tray is opened, the disc tray closes, and the unit enters stop or pause mode.

16 PLAY key (CD, CDV, LD)

Press this key to start play. When this key is pressed while the disc tray is opened, the disc tray closes and the unit enters play mode. When this key is pressed during other modes (pause, still, etc.), its mode is released and normal play is resumed.

17 SPEED set keys (CAV)

These keys are used for selecting the play speed within 10 steps during multiple speed play (see page 31) on CAV (standard) discs. Pressing the UP key increases the speed and pressing the DOWN key decreases it.

On-screen display	*12	*3	-----
Speed	12 times faster (x12)	3 times faster (x3)	-----

18 SOUND select key (LD)

This key is for selecting the sound to be played from the disc and output from the R/L audio signal output jacks.

The selected audio signal changes in the order of STEREO → 1/L-CH → 2/R-CH every time the key is pressed. (See page 25.)

19 D/A-CX key (LD)

Used to select the sound mode of a disc between analog and digital. The selected mode is displayed on the screen for about 2 seconds.

This key is also used to manually turn ON/OFF the CX noise reduction system. When playing analog sound discs with the  mark, press this key to manually activate the CX Noise Reduction system. "CX ON" will appear on the screen for about 2 seconds. To deactivate the CX Noise Reduction system, press this key again. The "CX OFF" is displayed on the screen for about 2 seconds. Some discs will activate the noise reduction system automatically.

20 REPEAT key (CD, CDV, LD)

This key is used to set repeat mode to either single or full. It is also used to release repeat mode (single, full or A-B repeat mode). (See page 30.)

21 A-B repeat key (CD, CDV, LD)

This key is used to specify the beginning point and the end point for A-B repeat play.

22 Numeric keys (CD, CDV, LD)

These keys are used to select the desired chapter number, frame number or time number of the LD disc, or the track number, index number, or time number of the CD or CDV disc for the various search modes.

23 CHAPTER/TRACK keys (CD, CDV, LD)

- + : When this key is pressed during play, the beginning of the next chapter or track is detected.
When it is kept pressed, the chapter or track number is advanced continuously.
- : When this key is pressed during play, the beginning of the current chapter or track is detected.
If it is kept pressed, the chapter or track number is reversed continuously.

These keys are also used for re-programming, or to skip between programs during program play.

24 SCAN keys (CD, CDV, LD)

- ▶▶ : When this key is pressed during play, play is advanced at high speed.
 - ◀◀ : When this key is pressed during play, play is reversed at high speed.
In the scan mode, during the first 3 seconds, play is advanced at lower speed (about 15 times faster than normal play speed), after this time play is advanced at higher speed (about 60 times faster).
- * In this mode, sound from the LD, or the video section of a CDV is not produced.

25 MULTI. SPEED PLAY keys (CAV)

- ▶ : This key is used to advance the picture at the speed selected by the SPEED keys during LD (CAV) disc play.
 - ◀ : This key is used to reverse the picture at the speed selected by the SPEED keys during LD (CAV) disc play.
- To resume normal play, press the PLAY key.
This function is not available for LD (CLV) discs.
- * In this mode, sound is not produced.

26 STILL keys (CAV)

- ▶| : This key is used to display a still picture or for frame-by-frame play in the forward direction during LD (CAV) disc play.
If this key is pressed once, the picture freezes.
Every time it is pressed again, the picture advances frame-by-frame.
 - ◀| : This key is used to display a still picture or for frame-by-frame play in the reverse direction during LD (CAV) disc play.
If this key is pressed once, the picture freezes.
Every time it is pressed again, the picture reverses frame-by-frame.
- * If either of these keys is kept pressed, the picture will move frame-by-frame every 0.3 seconds.
* In this mode, sound is not produced.

27 VHF select key

Press this key to select either the input signal from the ANT IN input signal (such as TV broadcast signal) or the player signal.
The selected signal is output to the VHF OUT terminal on the rear panel.
The PLAYER indicator lights when the player signal is selected and the ANTENNA indicator lights when the input signal from the ANT IN is selected.

28 DISPLAY key (CD, CDV, LD)

With LD (CAV) discs, when this key is pressed during play, the chapter and frame numbers of the picture currently being seen are displayed on the screen.
With LD (CLV) discs, when this key is pressed during play, the chapter number and time are displayed.

* Some discs do not have chapter data, so the chapter number will not be displayed even when the DISPLAY key is pressed.

With a CD or CDV disc, pressing this key displays the TOTAL TIME, REMAIN TIME or TRACK TIME on the screen.

BEFORE OPERATING THE REMOTE CONTROL TRANSMITTER

29 **PROG. MEMORY key** (CD, CDV, LD)

Press this key in stop mode to set the unit to program mode, for CD, CDV, CAV, or LD disc. (See page 29.)

This key is also used for the memory function of each disc. (See page 27.)

30 **FRAME-TIME/INDEX key** (CD, CDV, LD)

Press this key to perform a frame search on a LD (CAV) disc or a time search on a LD (CLV) disc. (See page 27.)

During CD or CDV play, press this key for an index search. (See page 28.) This key is also used for memory search. (See page 27.)

■ **BATTERY INSTALLATION**

1. Remove the battery compartment cover.
2. Insert two size "AA" batteries verifying the correct (+/-) polarity.
3. After loading the batteries, close the cover until it clicks.

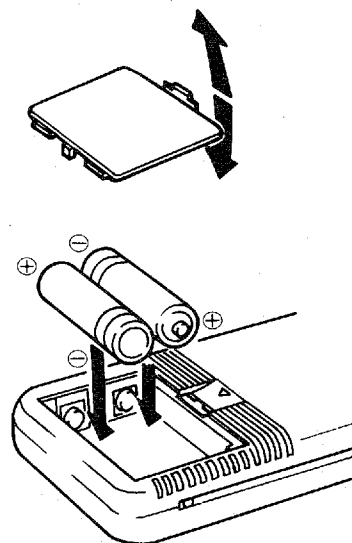

■ REPLACING THE BATTERY

When the remote-controllable distance decreases, the batteries are weak. In this case, relace the batteries ...

- Always insert batteries into the battery compartment correctly matching the positive (+) and negative (-) polarities as shown in the display inside the compartment.
- Never mix new and used batteries together.
- Batteries of the same size may have different voltages. Do not mix different types of batteries together.

Rechargeable batteries ...

- Both rechargeable and non-rechargeable batteries are available. Be sure to use the batteries in accordance with the caution labels affixed to them.

Remote control transmitter operation ...

- When the remote control transmitter is not to be used for a long period of time, remove the batteries to avoid damage from possible battery leakage.
- When the batteries are exhausted, replace them with new ones.

To prevent a serious accident ...

- Never disassemble or heat up the batteries or throw them into the fire. When dumping, dispose of them with noncombustibles.
- Never short-circuit the battery by connecting the positive and negative polarities directly with a piece of metal, etc.

When leakage happens ...

- Wipe off the battery fluid inside the battery compartment completely, and load new batteries.

■ NOTES ON REMOTE CONTROL TRANSMITTER

Usable range of the remote control transmitter.

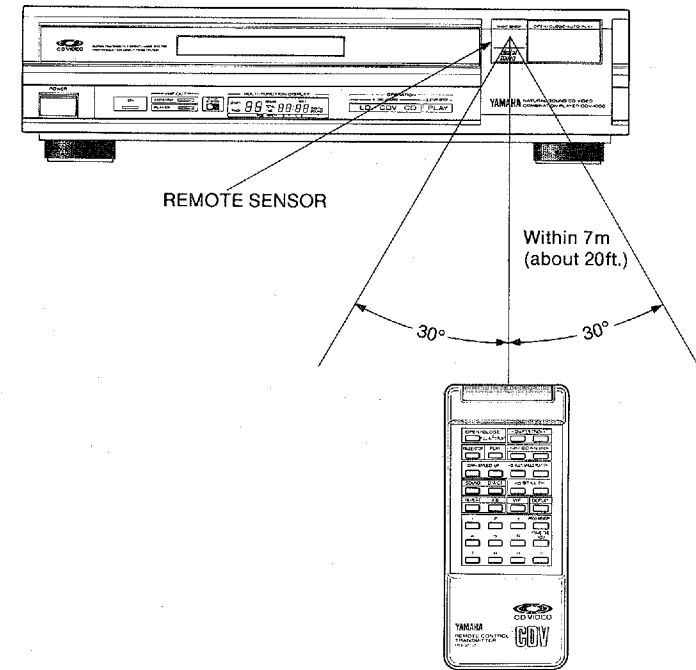

DISC HANDLING PRECAUTIONS

When the remote control transmitter does not function ...

When this happens, the batteries may be exhausted. Replace with new ones. And check the player's power.

Provided remote control transmitter is ...

Exclusively for use with this player. If it is used with another equipment, it may not function.

Careful operation is required ...

Do not spill liquids on the remote control transmitter and do not subject to the excessive shock or drop it.

Take care not to leave the remote control transmitter in an excessively hot or highly humid place, such as near a heater or in the bathroom.

Be careful not to expose the transmitter sensor to intense light or direct sunlight.

When the remote control sensor is exposed to intense light, the remote control transmitter may not function or become difficult to operate.

■ DO NOT USE DAMAGED DISCS

Discs rotate inside the player at high speeds. Do not use damaged (warped, cracked, etc.) discs. The player may be damaged.

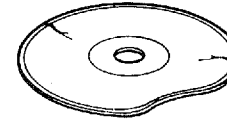

* Warped discs may not be played or picture quality may be degraded.

■ HOW TO TAKE OUT THE CD OR CDV DISC

Open the CD or CDV storage case with both hands, hold the disc by the edges and take out the disc while pressing the center clip.

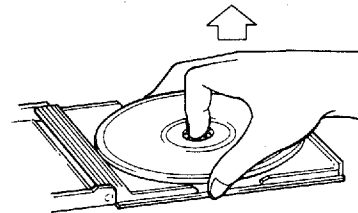

CD

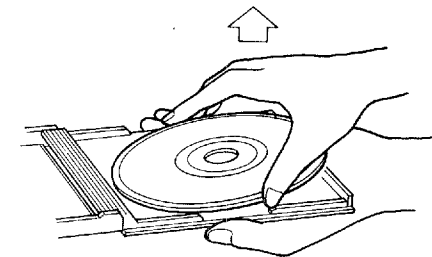

CDV

■ DISC HOLDING

Holding with both hands ...

Hold the disc by its rims with both hands, as shown below.

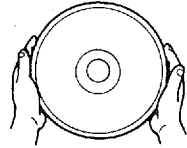

Holding with one hand ...

Hold the disc by its center hole and rim, as shown below.

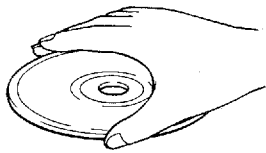

CD or CDV

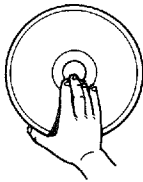

LD

Do not stick a paper, etc. on the disc surface or touch it with your finger.

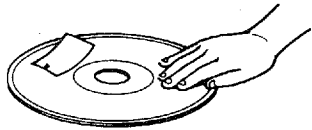

■ DISC MAINTENANCE

In order to obtain the highest quality picture and sound from your videodiscs, wipe off dust, dirt or finger-prints on the surface of the disc using soft cloth, etc. before use.

When extremely dirty, dip a soft cloth into water and wring it out to wipe. Then using a dry cloth, wipe it again.

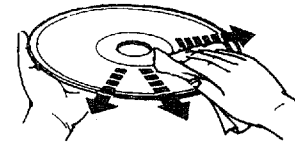

Wipe out in a radial direction.

Scratched discs may not play or may cause abnormal noise in the player. Avoid playing such discs, since they may overload the player's mechanism.

Do not use record cleaner sprays, benzene or static prevention sprays, etc. on videodiscs.

■ DISC STORAGE

To prevent warping, remove a disc from the player after playing. Then return it to its jacket and store it vertically in a location not subject to high temperature or humidity. Be sure to read all instructions printed on discs and their jackets.

DISC PLAY (CD, CDV, LD)

1. Press the POWER switch to turn the player on.
The ON indicator will light.
2. Press the OPEN/CLOSE-AUTO PLAY key on the player, or the OPEN/CLOSE-FULL AUTO PLAY key on the remote control transmitter, to open the disc tray.
3. Place a disc on the disc tray.
When playing a CD or CDV disc:
Set the disc on the innermost guide with the label side facing up.
When playing an 8-inch disc:
Set the disc firmly within the inner guide.
When playing a 12-inch disc:
Set the disc securely within the outermost guide, with the label side you want to play facing up.
4. Close the disc tray.
There are 4 ways to close the disc tray.
 - Push the disc tray lightly.
 - Press the OPEN/CLOSE-AUTO PLAY key on the player.
 - Press the OPEN/CLOSE-FULL AUTO PLAY key on the remote control transmitter.
 - Press the PLAY key on the remote control transmitter.Play will start automatically.
With a CD, play starts from the beginning of the first track.
With a CDV, play starts at the beginning of the video section. When play of the video section is completed, the audio section is automatically played.
With LD, play starts at the beginning of the disc.

NOTES:

- Do not move the player during play.
During play, the disc rotates at a high speed. In this condition, lifting the player up or moving it may damage the disc surface. When moving the player, be sure to stop the unit and remove the disc.
 - Be sure to close the disc tray.
A strong force (especially in a vertical direction) applied to the disc tray when out, may cause malfunction.
Do not place any objects, other than discs, on the disc tray, and be sure to close it after use.
5. To temporarily stop play, press the PAUSE/STOP key on the remote control transmitter once.
To resume play from the pause point, press the PLAY key.
If the PAUSE/STOP key is pressed twice, the player enters stop mode.
To start play again, press the PLAY key.
In the stop mode, pressing the FRAME-TIME/INDEX key, then PLAY key starts play at the point at which the play has been stopped.
 6. To take the disc out of the player...
Press the OPEN/CLOSE-FULL AUTO PLAY key on the remote control transmitter, or the OPEN/CLOSE-AUTO PLAY key on the player. The player enters stop mode and disc rotation stops.
Wait for a while before opening the disc tray.
When the disc tray is fully open, remove the disc from the disc tray.

- **For discs with automatic picture stop function (CAV)**

Some CAV discs have a special information signal, called the Picture Stop code, recorded on them.

When playing these discs, the player automatically enters still play mode when play reaches the frame designated by the picture stop code.

Normal play will continue by pressing the PLAY key, etc. For more details, refer to the disc envelope.

- **When playing an LD disc having bilingual sound tracks ...**

When power is turned on, the player is in STEREO mode.

Thus, when playing a disc having bilingual sound tracks, the two languages are mixed. In this case, press the SOUND key on the remote control transmitter so that only the desired language is obtained. Every time the SOUND key is pressed, the language changes in the order STEREO → 1/L-CH → 2/R-CH → STEREO. (When this key is first pressed, the mode is displayed on the monitor screen. Press it again to change to the next mode.)

[Reproduced sound mode and SOUND key]

On-screen display	VHF OUT output	AUDIO SIGNAL output	
		L	R
STEREO	Mixture of 1/L and 2/R (mono)	1/L	2/R
1/L-CH	1/L	1/L	1/L
2/R-CH	2/R	2/R	2/R

* When the disc tray is opened and closed again, the selected language (sound track mode) is cancelled and STEREO mode is automatically selected.

- **When playing a disc having the  mark**

Press the D/A-CX key on the remote control transmitter.

When this key is pressed, the CX noise reduction circuit is activated. This improves the signal-to-noise ratio and expands the dynamic range; resulting in noiseless, high fidelity sound.

On some CX discs, a special code is recorded which automatically turns the CX system on and off. When such a disc is played, the player reads the code to turn the CX circuitry on and off automatically and the D/A-CX key will not function (functions only for the D/A selection).

* CX is a trademark of Columbia Broadcasting System Inc.

- **To display the chapter and frame numbers of an LD or the track/index and time of a CD or CDV on the monitor screen**

Press the DISPLAY key on the remote control transmitter.

- When playing an LD (CAV) disc, the chapter and frame numbers are displayed.
- When playing an LD (CLV) disc, the chapter and time numbers are displayed.
- When playing the video section of a CDV, the track/index numbers and track time are displayed.
- When playing the audio section of a CDV or CD, pressing the DISPLAY key changes the time display from TOTAL TIME, to REMAIN TIME, to TRACK TIME and back to TOTAL TIME.

SEARCH OPERATION (CD, CDV, LD)

■ SCAN SEARCH (CD, CDV, LD)

Press the ►► key on the remote control transmitter to fast-forward play, and press the ◀◀ key to fast-reverse play. For the first 3 seconds after being pressed, the picture is played 15 times faster than normal speed.

Then, play is advanced 60 times faster.

In this mode, sound from an LD and the video section of a CDV is not produced.

When the SCAN key is pressed, the picture is fast-forwarded or fast-reversed and seen on the monitor screen.

* When playing a CLV or the video section of a CDV, the picture may fluctuate on the screen.

■ CHAPTER/TRACK SKIP (CD, CDV, LD having chapter numbers)

The beginning of the next or the current chapter (LD) or track (CD, CDV) can be located with this function.

- To skip to the beginning of the next chapter/track, press the "+" key.
 - * When the chapter number of a CDV or CLV exceeds the recorded number when trying to skip, the "+" key will not function.
- To skip to the beginning of the current chapter or track, press the "-" key.
 - * Watch the numbers when pressing the key for reverse skipping. Press it once to skip to the beginning of the current chapter or track, press it twice to return to the beginning of the chapter or track before the current one.

* Chapter skipping on a LD does not function for discs without chapter numbers.

In this mode, the picture and sound are not produced.

When the key is pressed repeatedly, the play skips according to the times it is pressed.

When these keys are pressed during program play, play moves to the next or previous programmed selection.

■ CHAPTER/TRACK SEARCH (CD, CDV, LD having chapter numbers)

This function searches for the beginning of any desired chapter (LD) or track (CD, CDV).

To designate the chapter number, use the numeric keys on the remote control transmitter.

For example, to search for chapter or track 8 ...

Press the "8" numeric key, then the PLAY key on the remote control transmitter. The player enters search mode. Chapter or track 8 is played from the beginning.

* When chapter search is performed during still mode with a LD (CAV) disc, the picture is frozen at the beginning of the designated chapter. When the chapter, frame (CAV), or time (CLV) numbers exceed the recorded numbers and a search is performed, the outer edge (the end of the current program side) is reached and "END" is displayed. On CAV discs, when the STILL or MULTI, SPEED PLAY key is pressed during a search, the player will play in that mode after searching.

■ FRAME NUMBER SEARCH (CAV)

With this function, the picture of the designated frame number is located, and can be played in normal or in still mode.

To search for frame number 350

1. Press the FRAME-TIME/INDEX key.
2. Press the "3", "5" and "0" numeric keys.
3. Press the PLAY key.

The picture plays normally from the designated frame number point.

- When a still picture is desired, press the STILL key (|◀ or ▶|).
The picture is played in still mode at the designated frame number.

■ TIME NUMBER SEARCH (CLV)

With this function, the picture corresponding to the elapsed time from the beginning of the program can be located.

The elapsed time is recorded in a minimum unit of "seconds" or "minutes". For each discs, a time search operation is possible by second and by minute.

To search for a picture 24 minutes from the beginning of the disc

- When the time is indicated in "minutes"
1. Press the FRAME-TIME/INDEX key.
 2. Press the "2" and "4" numeric keys.
 3. Press the PLAY key.
The picture is played from the 24-minute elapsed time position.

To search for the picture 24 minutes and 30 seconds from the beginning of the disc

- When the time is indicated in "seconds"
1. Press the FRAME-TIME/INDEX key.
 2. Press "2", "4", "3" and "0" numeric keys.
 3. Press the PLAY key.
The picture is played from the 24 minutes and 30 second elapsed time position.

■ MEMORY SEARCH (CD, CDV, LD)

With this function, the player searches for a memorized point and play can start at that point.

1. Press the PROG. MEMORY key on the remote control transmitter at the point you want to search for.

"MEMORY" is displayed on the screen for about 2 seconds, and the frame number (CAV) or time (CD, CDV, CLV) is memorized.

NOTE:

With a CD or CDV, be sure to set the player to the TOTAL TIME display with the DISPLAY key for this function. Time cannot be memorized in the REMAIN TIME mode, and the time regardless of the current track, is memorized in the TRACK TIME mode.

2. Press the FRAME-TIME/INDEX key on the remote control transmitter to recall the memorized frame number or time number. In the case of a CD or CDV, press the FRAME-TIME/INDEX key twice to recall the memorized time.
3. Press the PLAY key. Play will start at the memorized point.

■ TIME SEARCH (CD, CDV)

With this function, the time of a CD or CDV can be specified and play can be started at that time.

● To start at the 2-min, 34-sec point of track 2

1. Press the "2" numeric key. "2" is displayed in the MULTI-FUNCTION DISPLAY.
2. Press the FRAME-TIME/INDEX key twice. The TIME indicator in the MULTI-FUNCTION DISPLAY blinks.
3. Press the "2", "3", and "4" numeric keys to specify the time.
4. Press the PLAY key of the remote control transmitter. Play starts at the 2-min, 34-sec point of track 2.

● To start at the 24-min, 30-sec point from the beginning of the disc

1. Set the player to the TOTAL TIME display with the DISPLAY key on the remote control transmitter.
2. Press the FRAME-TIME/INDEX key twice. The TIME indicator in the MULTI-FUNCTION DISPLAY blinks.
3. Press the "2", "4", "3", and "0" numeric keys to specify the time.
4. Press the PLAY key of the remote control transmitter.
Play starts at the 24-min, 30-sec point from the beginning of the disc.

■ TRACK/INDEX SEARCH (CD, CDV)

With this function, you can start CD or CDV play at a specified track/index number.

To start at track 3, index 2

1. Press the PAUSE/STOP key on the remote control transmitter to set the player to stop mode.
2. Press the "3" numeric key to specify the track number. "3" is displayed in the MULTI-FUNCTION DISPLAY.
3. Press the FRAME-TIME/INDEX key on the remote control transmitter. The INDEX indicator in the MULTI-FUNCTION DISPLAY blinks.
4. Press the "2" numeric key to specify the index number.
5. Press the PLAY key of the remote control transmitter.
Play starts at track 3, index 2.

■ INDEX SEARCH (CD, CDV having index numbers)

This function searches for the beginning of any desired index number of the selection being played. To designate the index number, use the numeric keys on the remote control transmitter.

To search for index 2 ...

1. Press the FRAME-TIME/INDEX key on the remote control transmitter.
2. Press the "2" numeric key.
3. Press the PLAY key on the remote control transmitter.
The player searches for index 2 of the CD or CDV and play starts at the beginning of index 2.

PROGRAM PLAY (CD, CDV, LD)

■ PROGRAMMING

With this function, you can play in any desired order.

1. Press the PAUSE/STOP key on the remote control transmitter to set the player to stop mode.
2. Press the PROG. MEMORY key on the remote control transmitter. "PROGRAM" is displayed on the monitor screen, a white box blinks on the screen and the MULTI-FUNCTION DISPLAY shows "P-01".
3. Press a numeric key to specify the chapter (LD) or track (CD, CDV) number from which you want to play.
The specified chapter or track number is displayed on both the monitor screen and MULTI-FUNCTION DISPLAY.
4. Press the PROG. MEMORY key.
5. Repeat steps 3 and 4 for every selection.
Up to 15 selections can be memorized.
6. When presetting is completed, press the PLAY key on the remote control transmitter to start program play.

■ TO CORRECT THE PROGRAM

1. Press the PAUSE/STOP key twice to set the player to stop mode.
2. Press the PROG. MEMORY key.
3. Press the CHAPTER/TRACK key, or the PROG. MEMORY key, on the remote control transmitter to move the blinking white box to the position to be corrected.
4. Specify a new chapter or track number with the numeric keys.
5. Press the PROG. MEMORY key.
6. Repeat steps above for other chapter or track numbers.
7. Press the PLAY key on the remote control transmitter to start program play.

STILL/STEP PLAY (CAV)

■ STILL PLAY (CAV)

The picture can be frozen by pressing either of the STILL keys (|◀, ▶|) on the remote control transmitter.

During still/step play, the frame number is displayed in red on the screen. (To check this, press the DISPLAY key.)

● Fast forward/reverse in still mode

In still mode, when the SCAN ►► key is pressed, the picture is fast-forwarded, and re-enters still mode when the key is released.

In the same way, when the SCAN ◀◀ key is pressed, the picture is fast-reversed, and re-enters still mode when the key is released.

■ STEP PLAY (Frame-by-frame play)

[Forward direction]

After entering still mode by pressing the ▶| key, the picture is advanced frame-by-frame every time the ▶| key is pressed.

When the key is kept pressed, the still picture is advanced continuously.

[Reverse direction]

After entering still mode by pressing the |◀ key, the still picture is reversed every time the |◀ key is pressed.

When the key is kept pressed, the still picture is reversed continuously.

■ TO RESUME NORMAL PLAY

Press the PLAY key.

REPEAT PLAY (CD, CDV, LD)

■ TO REPEAT THE SINGLE SELECTION

Press the REPEAT key. The REPEAT S indicator lights on the MULTI-FUNCTION DISPLAY. "REP S" is displayed on the screen and the single selection of the disc is repeatedly played.

■ TO REPEAT THE ENTIRE SIDE OF THE DISC

Press the REPEAT key twice so that the REPEAT F indicator lights on the MULTI-FUNCTION DISPLAY. "REP F" is displayed on the screen and the entire side of the disc is repeatedly played.

■ A-B REPEAT PLAY

This function allows you to repeat play an interval between any 2 points you designate.

1. At the beginning of the interval you want to repeat play, press the A-B repeat key. At this time, point A is designated. "REP A" is displayed on the screen for several seconds.
 2. At the end of the interval you want to repeat play, press the A-B repeat key again. At this time, point B is designated. Then the interval between points A and B are played repeatedly.
- * During A-B repeat play, the interval points can be re-designated.

NOTE:

The repeat interval on CLV discs:

With CLV discs, repeat play is performed by the time numbers recorded on the disc. CLV discs are divided into two types: discs with a minimum unit of "seconds" and discs with a minimum unit of "minutes". For this reason, the interval set with the A-B key may not exactly agree with the actual repeat interval when playing discs having a minimum unit of "minutes".

For a disc with a minimum unit of "minutes", the minimum interval for repeat play is one minute. Therefore, when the A-B key is pressed with the same "minute" indicators as the start and end points, a one-minute repeat play will be performed.

■ TO CANCEL THE REPEAT PLAY

Press the REPEAT key to cancel single, entire side repeat, or A-B repeat play.

("REP OFF" is displayed on the screen to show that repeat play is cancelled.)

Repeat mode is also cancelled when the disc tray is opened or when power is turned off.

MULTIPLE SPEED PLAY (CAV)

The desired play speed can be selected from 10 speed modes, using the SPEED (UP/DOWN) set keys on the remote control transmitter.

This function is called "multiple speed play".

When power is turned on and the player is set to multiple speed mode, the x3 speed mode (3 times faster) is set. To speed play up, press the UP key, and to slow it down, press the DOWN key.

DOWN key	On-screen display	Play speed		Up key
When the power is turned on and the unit is set to multiple speed play mode. Every time the key is pressed, play speed becomes slower.	*12	x12	High speed	Every time the key is pressed, play speed becomes higher.
	*3	x3		
	*2	x2		
	*1	Standard		
	1/2	1/2	Slow speed	
	1/4	1/4		
	1/8	1/8		
	1/16	1/16		
	1 SEC	1 frame/sec		
	3 SEC	3 frame/sec		

- * The selected speed is stored in memory even when the player enters other modes. However, when power is turned off, x3 mode resumes.
- * Play speed can be preset by pressing the UP or DOWN key before entering Multiple Speed Play mode (in any mode).
- * During multiple speed play (even at standard speed), sound is not produced.

■ HIGH-SPEED PLAY

To play at x12 speed

1. Press the ► key. (For reverse play, press the ◀ key. At this time, the picture is played at x3 (3 times the normal) speed, and the frame number changes to green on the screen. (To check this, press the DISPLAY key.) At this time, the sound goes off.
2. Press the UP key once. The picture is played at x12 speed.

■ SLOW-SPEED PLAY

To play at half speed

1. Press the ◀ key. (For forward play, press the ► key.) At this time, the picture is played at x3 (3 times the normal) speed, and the frame number changes to green on the screen. (To check this, press the DISPLAY key.) At this time, the sound goes off.
2. Press the DOWN key three times. The picture is played slowly at half speed.

■ TO RESUME NORMAL PLAY

Press the PLAY key.

SPECIFICATIONS

FORMAT

System (or Type): Optical videodisc system complies with MCA/Philips specifications (Laservision system)

Usable disc: CD: 70 min.
CDV: Video 5 min.
Audio 20 min.

12-inch CLV disc: 60 min./side
12-inch CAV disc: 30 min./side
8-inch CLV disc: 20 min./side
8-inch CAV disc: 14 min./side

Spindle revolution: CD: 500 to 200 rpm
CDV: Video 2,700 to 1,800 rpm
Audio 500 to 300 rpm
CLV disc: 1,800 to 600 rpm
(12-inch disc)
CAV disc: 1,800 rpm

INPUT/OUTPUT TERMINALS

INPUT: ANT IN: VHF input (75-ohms)

OUTPUTS: VIDEO SIGNAL: 1 Vp-p (75-ohms load, sync. negative) RCA pin jack

VHF OUT: Applied to NTSC standard TV receiver
F-type jack (75-ohms, unbalanced),
Channel 3 or 4 switchable

AUDIO SIGNAL: Digital; 200 mV (1 kHz, -20 dB)
Analog; 200 mV (1 kHz, 40%)
Stereo or 2-channel individual Stereo pin jacks

MONO: Pin jack for mono TV/VCR

Frequency response: 2 Hz to 20 kHz ± 0.5 dB (digital)

Signal-to-noise ratio: 97 dB

Dynamic range: 94 dB

Channel separation: 90 dB or more (1 kHz, digital)

Wow and flutter: Less than measurable range

Horizontal resolution: 425 lines

Distortion rate: 0.003% (1 kHz, -20 dB)

Accessory terminal I/O port: Used for external controlling of the functions of this unit in the future.

GENERAL

Power requirements: AC 120V, 60 Hz

Power consumption: 35W

Weight: 8.0 kg (17 lb 10 oz)

Dimensions: 435 (W) x 108 (H) x 401 (D) mm
(17-1/8" x 4-1/4" x 15-13/16")

Operable temperature/

humidity range: +5 to 35°C (41 to 95°F)/0 to 90%
(No condensation)

ACCESSORIES

Remote Control Transmitter

Size "AA" battery x 2

75-ohm/300-ohm antenna adapter x 1

Coaxial cable with F-type connector x 1

Audio cord x 1

Video cord x 1

OTHERS

Auto audio digital output: When playing discs having a digitally-recorded audio signal, audio reproduction circuit is automatically changed to the audio digital circuit.

Specifications and design subject to change without notice.

TROUBLESHOOTING

When this unit functions abnormally during operation, first check the following items. When the unit continues to function abnormally, or when an abnormality appears other than listed below, turn off the player's power and disconnect the AC plug, then consult your YAMAHA dealer or servicing personnel.

< Video >

SYMPTOM	POSSIBLE CAUSE	REMEDY	
The disc is turning, but the picture is not displayed.	The TV (color monitor) power is OFF.	If it is OFF, turn the power of the TV (color monitor) ON.	
	Connections are incorrect.	Connect equipment properly again. (See page 7.)	
	When the VHF TV input is used:	The output channel used by this unit is different from the vacant TV channel.	Set the TV channel to the vacant channel (either of CH3 and CH4 which is not used by any broadcast station), then set the CHANNEL switch of this unit to "L" if the vacant channel is CH3, or to "H" if it is CH4. (See page 13.)
		The ANTENNA indicator is lit.	Press the VHF key so that the PLAYER indicator lights.
	A one-sided disc may be placed upside down.	Place the disc with the label on which the required program is indicated facing up.	
TV programs (VHF broadcast) cannot be seen.	The VHF antenna connection is incorrect.	Connect the VHF antenna properly.	
	The PLAYER indicator is lit.	Press the VHF key once so that the ANTENNA indicator lights.	
TV programs (UHF broadcast) cannot be seen.	The UHF antenna is connected to the ANT IN jack of this unit.	Connect the UHF antenna directly to the UHF input terminal of the TV. (See page 7.)	
Multi-speed play, still/frame-advance play and frame search are not possible.	The disc being played is a CLV or CDV disc.	The CLV and CDV discs do not allow multi-speed play, still/frame-advance play and frame search.	
Chapter skip and chapter search are not possible.	The chapter No. has not been recorded on the disc being played.	Press the DISPLAY key on the remote control unit and see if any chapter No. is displayed	
The scene played by time number search is not the intended scene.	Press the DISPLAY key on the remote control unit, and check whether the disc's time Nos. have been recorded per "minutes" basis or per "second" basis.	Refer to the description of time number search. (See page 27.)	
TV program reception is poor, or the picture is stretchy.	The TV wave in your listening area is weak.	When viewing TV programs, turn this unit OFF.	
The picture quality is poor, or it is distorted.	The disc is very dirty.	Clean the disc. (See page 23.)	
	The disc is deformed (warped, etc.).	Straightening the disc may sometimes reduce the deformation. (See page 22.)	

< Audio >

SYMPTOM	POSSIBLE CAUSE		REMEDY
Playback does not start although a disc has been set in place.	The disc is placed upside down.		Place the disc with the labeled side facing up.
	The disc is very dirty.		Clean the disc. (See page 23.)
Sound is not reproduced.	Connections are incorrect.		Connect equipment properly again (See page 7.)
	A CAV disc is being played in the multi-speed play mode.		Press the PLAY key to enter the standard play mode.
	The volume control of the TV, amplifier or receiver connected is set at the minimum position.		Adjust the volume control of the TV, amplifier or receiver as required.
	When the TV is equipped with audio input jacks.	Audio cord connections are incorrect.	Connect the audio cords properly. (See page 10.)
The sound is unnatural.	A disc without <input checked="" type="checkbox"/> marking is being reproduced with the D/A-CX key set to ON.		Press the D/A-CX key to that "CX-OFF" is displayed on the screen.

< General >

SYMPTOM	POSSIBLE CAUSE		REMEDY
Power cannot be turned on.	The power cord is disconnected from the power outlet.		Insert it firmly.
Playback cannot be started.	No disc has been loaded.		Load a disc.
The disc table comes out involuntarily.	The disc is very dirty.		Clean the disc (See page 23.)
	The disc is deformed (warped, etc.).		Straightening the disc may sometimes reduce the deformation. (See page 22.)
The remote control unit cannot be operated.	The batteries inside the remote control unit are exhausted.		Replace batteries. (See page 20.)
	The remote control unit is operated from an incorrect distance or angle.		Operate it from less than 7 meters and 30° (See page 21.)
The TV operated erroneously when the remote control unit of this unit is operated.	When the TV used is equipped with wireless remote control:	The TV is placed near this unit.	Place the TV and this unit apart, or cover the remote control light receiver of the TV.
A hum noise is heard.	The output cord plug is connected improperly.		Insert the output cord plug securely again.
The tuner is interfered with noise.	The tuner is placed near this unit.		Place this unit apart from the tuner, or turn the power of this unit OFF.



To play an 8 cm (3-1/8") compact disc (CD single)

The CDV-1000 can play an 8 cm (3-1/8") compact disc (up to 20 minutes digital audio capacity).
The operation is the same as those for the 12 cm (5") compact disc. To play an 8 cm (3-1/8") compact disc, place the disc in the shaded part of the disc tray as shown below.

Pour lire un disque audionumérique de 8 cm (CD simple)

Le CDV-1000 peut lire un disque audionumérique de 8 cm (capacité de jusqu'à 20 minutes d'audio numérique).
Le fonctionnement est le même que pour les disques audionumériques de 12 cm. Pour lire un disque audionumérique de 8 cm, placer le disque sur la partie ombrée du tiroir de disque, comme indiqué ci-dessous.

