



# Clavinova®

CVP-709

CVP-705

Owner's Manual  
Mode d'emploi  
Manual de instrucciones

## Thank you for purchasing this Yamaha Clavinova!

We recommend that you read this manual carefully so that you can fully take advantage of the advanced and convenient functions of the instrument. We also recommend that you keep this manual in a safe and handy place for future reference.

**Before using the instrument, be sure to read "PRECAUTIONS" on pages 5-6.**

For information on assembling the instrument, refer to the instructions at the end of this manual.

## Nous vous remercions d'avoir choisi le Clavinova de Yamaha !

Nous vous conseillons de lire attentivement ce mode d'emploi afin de tirer pleinement profit des fonctions avancées et pratiques de votre instrument. Nous vous recommandons également de garder ce manuel à portée de main pour toute référence ultérieure.

**Avant d'utiliser l'instrument, lisez attentivement la section « PRÉCAUTIONS D'USAGE » aux pages 5 et 6.**

Pour plus d'informations sur l'assemblage de l'instrument, reportez-vous aux instructions figurant à la fin de ce manuel.

## Gracias por adquirir el Yamaha Clavinova

La lectura detenida de este manual le permitirá disfrutar de las útiles y avanzadas funciones del instrumento. Recomendamos guardar el manual en un lugar seguro y accesible, para futuras consultas.

**Antes de utilizar el instrumento, lea las "PRECAUCIONES", en las páginas 5-6.**

Para obtener más información sobre el montaje del instrumento, consulte las instrucciones que encontrará al final de este manual.

English   
Français   
Español



EN FR ES

# SPECIAL MESSAGE SECTION

**PRODUCT SAFETY MARKINGS:** Yamaha electronic products may have either labels similar to the graphics shown below or molded/stamped facsimiles of these graphics on the enclosure. The explanation of these graphics appears on this page. Please observe all cautions indicated on this page and those indicated in the safety instruction section.

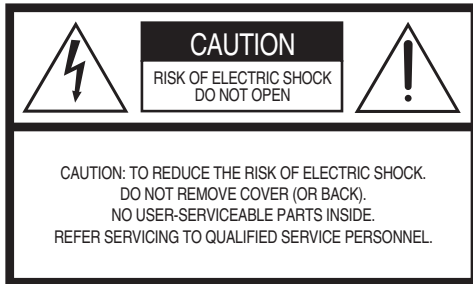

See bottom of Keyboard enclosure for graphic symbol markings.



The exclamation point within the equilateral triangle is intended to alert the user to the presence of important operating and maintenance (servicing) instructions in the literature accompanying the product.



The lightning flash with arrowhead symbol, within the equilateral triangle, is intended to alert the user to the presence of uninsulated “dangerous voltage” within the product’s enclosure that may be of sufficient magnitude to constitute a risk of electrical shock.

**IMPORTANT NOTICE:** All Yamaha electronic products are tested and approved by an independent safety testing laboratory in order that you may be sure that when it is properly installed and used in its normal and customary manner, all foreseeable risks have been eliminated. DO NOT modify this unit or commission others to do so unless specifically authorized by Yamaha. Product performance and/or safety standards may be diminished. Claims filed under the expressed warranty may be denied if the unit is/has been modified. Implied warranties may also be affected.

**SPECIFICATIONS SUBJECT TO CHANGE:** The information contained in this manual is believed to be correct at the time of printing. However, Yamaha reserves the right to change or modify any of the specifications without notice or obligation to update existing units.

**ENVIRONMENTAL ISSUES:** Yamaha strives to produce products that are both user safe and environmentally friendly. We sincerely believe that our products and the production methods used to produce them, meet these goals. In keeping with both the letter and the spirit of the law, we want you to be aware of the following:

**Battery Notice:** This product MAY contain a small non-rechargeable battery which (if applicable) is soldered in place. The average life span of this type of battery is approximately five years. When replacement becomes necessary, contact a qualified service representative to perform the replacement.

**Warning:** Do not attempt to recharge, disassemble, or incinerate this type of battery. Keep all batteries away from children. Dispose of used batteries promptly and as regulated by applicable laws. Note: In some areas, the servicer is required by law to return the defective parts. However, you do have the option of having the servicer dispose of these parts for you.

**Disposal Notice:** Should this product become damaged beyond repair, or for some reason its useful life is considered to be at an end, please observe all local, state, and federal regulations that relate to the disposal of products that contain lead, batteries, plastics, etc.

**NOTICE:** Service charges incurred due to lack of knowledge relating to how a function or effect works (when the unit is operating as designed) are not covered by the manufacturer’s warranty, and are therefore the owners responsibility. Please study this manual carefully and consult your dealer before requesting service.

**NAME PLATE LOCATION:** The graphic below indicates the location of the name plate. The model number, serial number, power requirements, etc., are located on this plate. You should record the model number, serial number, and the date of purchase in the spaces provided below and retain this manual as a permanent record of your purchase.

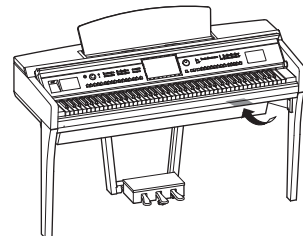

**Model** \_\_\_\_\_

**Serial No.** \_\_\_\_\_

**Purchase Date** \_\_\_\_\_

## FCC INFORMATION (U.S.A.)

### 1. IMPORTANT NOTICE: DO NOT MODIFY THIS UNIT!

This product, when installed as indicated in the instructions contained in this manual, meets FCC requirements. Modifications not expressly approved by Yamaha may void your authority, granted by the FCC, to use the product.

**2. IMPORTANT:** When connecting this product to accessories and/or another product use only high quality shielded cables. Cable/s supplied with this product MUST be used. Follow all installation instructions. Failure to follow instructions could void your FCC authorization to use this product in the USA.

**3. NOTE:** This product has been tested and found to comply with the requirements listed in FCC Regulations, Part 15 for Class "B" digital devices. Compliance with these requirements provides a reasonable level of assurance that your use of this product in a residential environment will not result in harmful interference with other electronic devices. This equipment generates/uses radio frequencies and, if not installed and used according to the instructions found in the users manual, may cause interference harmful to the operation of other electronic devices. Compliance with FCC regulations does not

guarantee that interference will not occur in all installations. If this product is found to be the source of interference, which can be determined by turning the unit "OFF" and "ON", please try to eliminate the problem by using one of the following measures:

Relocate either this product or the device that is being affected by the interference.

Utilize power outlets that are on different branch (circuit breaker or fuse) circuits or install AC line filter/s.

In the case of radio or TV interference, relocate/reorient the antenna. If the antenna lead-in is 300 ohm ribbon lead, change the lead-in to co-axial type cable.

If these corrective measures do not produce satisfactory results, please contact the local retailer authorized to distribute this type of product. If you can not locate the appropriate retailer, please contact Yamaha Corporation of America, Electronic Service Division, 6600 Orangethorpe Ave, Buena Park, CA90620

The above statements apply ONLY to those products distributed by Yamaha Corporation of America or its subsidiaries.

\* This applies only to products distributed by YAMAHA CORPORATION OF AMERICA.

(class B)

### COMPLIANCE INFORMATION STATEMENT (DECLARATION OF CONFORMITY PROCEDURE)

Responsible Party : Yamaha Corporation of America  
Address : 6600 Orangethorpe Ave.,  
Buena Park, Calif. 90620  
Telephone : 714-522-9011  
Type of Equipment : Digital Piano  
Model Name : CVP-709GP/CVP-709/CVP-705

This device complies with Part 15 of the FCC Rules.

Operation is subject to the following two conditions:

- 1) this device may not cause harmful interference, and
- 2) this device must accept any interference received including interference that may cause undesired operation.

See user manual instructions if interference to radio reception is suspected.

\* This applies only to products distributed by  
YAMAHA CORPORATION OF AMERICA.

(FCC DoC)

### IMPORTANT NOTICE FOR THE UNITED KINGDOM Connecting the Plug and Cord

IMPORTANT. The wires in this mains lead are coloured in accordance with the following code:

BLUE : NEUTRAL  
BROWN : LIVE

As the colours of the wires in the mains lead of this apparatus may not correspond with the coloured markings identifying the terminals in your plug proceed as follows:

The wire which is coloured BLUE must be connected to the terminal which is marked with the letter N or coloured BLACK. The wire which is coloured BROWN must be connected to the terminal which is marked with the letter L or coloured RED.

Making sure that neither core is connected to the earth terminal of the three pin plug.

\* This applies only to products distributed by  
YAMAHA CORPORATION OF AMERICA.

(FCC DoC)

(2 wires)

### OBSERVERA!

Apparaten kopplas inte ur växelströmskällan (nätet) så länge som den är ansluten till vägguttaget, även om själva apparaten har stängts av.

**ADVARSEL:** Netspændingen til dette apparat er IKKE afbrudt, så længe netledningen sidder i en stikkontakt, som er tændt — også selvom der er slukket på apparatets afbryder.

**VAROITUS:** Laitteen toisiopiiriin kytketty käyttökytkin ei irroita koko laitetta verkosta.

(standby)

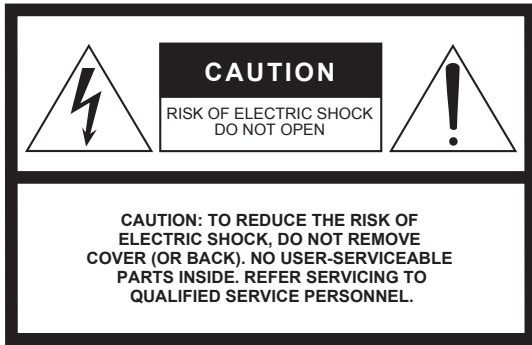

The above warning is located on the bottom of the unit.

## Explanation of Graphical Symbols

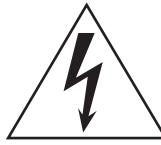

The lightning flash with arrowhead symbol within an equilateral triangle is intended to alert the user to the presence of uninsulated “dangerous voltage” within the product’s enclosure that may be of sufficient magnitude to constitute a risk of electric shock to persons.



The exclamation point within an equilateral triangle is intended to alert the user to the presence of important operating and maintenance (servicing) instructions in the literature accompanying the product.

# IMPORTANT SAFETY INSTRUCTIONS

- 1 Read these instructions.
- 2 Keep these instructions.
- 3 Heed all warnings.
- 4 Follow all instructions.
- 5 Do not use this apparatus near water.
- 6 Clean only with dry cloth.
- 7 Do not block any ventilation openings. Install in accordance with the manufacturer’s instructions.
- 8 Do not install near any heat sources such as radiators, heat registers, stoves, or other apparatus (including amplifiers) that produce heat.
- 9 Do not defeat the safety purpose of the polarized or grounding-type plug. A polarized plug has two blades with one wider than the other. A grounding type plug has two blades and a third grounding prong. The wide blade or the third prong are provided for your safety. If the provided plug does not fit into your outlet, consult an electrician for replacement of the obsolete outlet.
- 10 Protect the power cord from being walked on or pinched particularly at plugs, convenience receptacles, and the point where they exit from the apparatus.
- 11 Only use attachments/accessories specified by the manufacturer.
- 12 Use only with the cart, stand, tripod, bracket, or table specified by the manufacturer, or sold with the apparatus. When a cart is used, use caution when moving the cart/apparatus combination to avoid injury from tip-over. 
- 13 Unplug this apparatus during lightning storms or when unused for long periods of time.
- 14 Refer all servicing to qualified service personnel. Servicing is required when the apparatus has been damaged in any way, such as power-supply cord or plug is damaged, liquid has been spilled or objects have fallen into the apparatus, the apparatus has been exposed to rain or moisture, does not operate normally, or has been dropped.

### WARNING

TO REDUCE THE RISK OF FIRE OR ELECTRIC SHOCK, DO NOT EXPOSE THIS APPARATUS TO RAIN OR MOISTURE.

(UL60065\_03)

The model number, serial number, power requirements, etc., may be found on or near the name plate, which is at the bottom of the unit. You should note this serial number in the space provided below and retain this manual as a permanent record of your purchase to aid identification in the event of theft.

**Model No.**

\_\_\_\_\_

**Serial No.**

\_\_\_\_\_

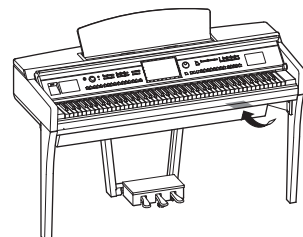

The name plate is located on the bottom of the unit.

(bottom\_en\_01)

# PRECAUTIONS

## PLEASE READ CAREFULLY BEFORE PROCEEDING

Please keep this manual in a safe and handy place for future reference.



### WARNING

Always follow the basic precautions listed below to avoid the possibility of serious injury or even death from electrical shock, short-circuiting, damages, fire or other hazards. These precautions include, but are not limited to, the following:

#### Power supply/Power cord

- Do not place the power cord near heat sources such as heaters or radiators. Also, do not excessively bend or otherwise damage the cord, or place heavy objects on it.
- Only use the voltage specified as correct for the instrument. The required voltage is printed on the name plate of the instrument.
- Use only the supplied power cord/plug.
- Check the electric plug periodically and remove any dirt or dust which may have accumulated on it.

#### Do not open

- This instrument contains no user-serviceable parts. Do not open the instrument or attempt to disassemble or modify the internal components in any way. If it should appear to be malfunctioning, discontinue use immediately and have it inspected by qualified Yamaha service personnel.

#### Water warning

- Do not expose the instrument to rain, use it near water or in damp or wet conditions, or place on it any containers (such as vases, bottles or glasses) containing liquids which might spill into any openings. If any liquid such as water seeps into the instrument, turn off the power immediately and unplug the power cord from the AC outlet. Then have the instrument inspected by qualified Yamaha service personnel.
- Never insert or remove an electric plug with wet hands.

#### Fire warning

- Do not put burning items, such as candles, on the unit. A burning item may fall over and cause a fire.

#### If you notice any abnormality

- When one of the following problems occur, immediately turn off the power switch and disconnect the electric plug from the outlet. Then have the device inspected by Yamaha service personnel.
  - The power cord or plug becomes frayed or damaged.
  - It emits unusual smells or smoke.
  - Some object has been dropped into the instrument.
  - There is a sudden loss of sound during use of the instrument.



## CAUTION

Always follow the basic precautions listed below to avoid the possibility of physical injury to you or others, or damage to the instrument or other property. These precautions include, but are not limited to, the following:

### Power supply/Power cord

- Do not connect the instrument to an electrical outlet using a multiple-connector. Doing so can result in lower sound quality, or possibly cause overheating in the outlet.
- When removing the electric plug from the instrument or an outlet, always hold the plug itself and not the cord. Pulling by the cord can damage it.
- Remove the electric plug from the outlet when the instrument is not to be used for extended periods of time, or during electrical storms.

### Assembly

- Read carefully the attached documentation explaining the assembly process. Failure to assemble the instrument in the proper sequence might result in damage to the instrument or even injury.

### Location

- Do not place the instrument in an unstable position where it might accidentally fall over.
- When transporting or moving the instrument, always use two or more people. Attempting to lift the instrument by yourself may damage your back, result in other injury, or cause damage to the instrument itself.
- Before moving the instrument, remove all connected cables, to prevent damage to the cables or injury to anyone who might trip over them.
- When setting up the product, make sure that the AC outlet you are using is easily accessible. If some trouble or malfunction occurs, immediately turn off the power switch and disconnect the plug from the outlet. Even when the power switch is turned off, electricity is still flowing to the product at the minimum level. When you are not using the product for a long time, make sure to unplug the power cord from the wall AC outlet.

### Connections

- Before connecting the instrument to other electronic components, turn off the power for all components. Before turning the power on or off for all components, set all volume levels to minimum.
- Be sure to set the volumes of all components at their minimum levels and gradually raise the volume controls while playing the instrument to set the desired listening level.

### Handling caution

- Do not insert a finger or hand in any gaps on the key cover or instrument. Also take care that the key cover does not pinch your finger.
- Never insert or drop paper, metallic, or other objects into the gaps on the key cover, panel or keyboard. This could cause physical injury to you or others, damage to the instrument or other property, or operational failure.
- Do not rest your weight on, or place heavy objects on the instrument, and do not use excessive force on the buttons, switches or connectors.
- Do not use the instrument/device or headphones for a long period of time at a high or uncomfortable volume level, since this can cause permanent hearing loss. If you experience any hearing loss or ringing in the ears, consult a physician.

### Using the bench (If included)

- Do not place the bench in an unstable position where it might accidentally fall over.
- Do not play carelessly with or stand on the bench. Using it as a tool or stepladder or for any other purpose might result in accident or injury.
- Only one person should sit on the bench at a time, in order to prevent the possibility of accident or injury.
- For benches that can be adjusted, do not adjust the bench height while sitting on the bench, since this can cause excessive force to be imposed on the adjustment mechanism, possibly resulting in damage to the mechanism or even injury.
- If the bench screws become loose due to extensive long-term use, tighten them periodically using the specified tool in order to prevent the possibility of accident or injury.
- Keep special watch over any small children so that they don't fall off the rear of the bench. Since the bench does not have a backrest, unsupervised use may result in accident or injury.

Yamaha cannot be held responsible for damage caused by improper use or modifications to the instrument, or data that is lost or destroyed.

Always turn the power off when the instrument is not in use.

Even when the [⏻] (Standby/On) switch is in standby status (power lamp is off), electricity is still flowing to the instrument at the minimum level.

When you are not using the instrument for a long time, make sure you unplug the power cord from the wall AC outlet.

# NOTICE

---

To avoid the possibility of malfunction/damage to the product, damage to data, or damage to other property, follow the notices below.

## ■ Handling

- Do not use the instrument in the vicinity of a TV, radio, stereo equipment, mobile phone, or other electric devices. Otherwise, the instrument, TV, or radio may generate noise. When you use the instrument along with an application on your iPhone, iPad or iPod touch, we recommend that you set “Airplane Mode” to “ON” on that device in order to avoid noise caused by communication.
- Do not expose the instrument to excessive dust or vibrations, or extreme cold or heat (such as in direct sunlight, near a heater, or in a car during the day) to prevent the possibility of panel disfiguration, damage to the internal components or unstable operation. (Verified operating temperature range: 5° – 40°C, or 41° – 104°F.)
- Do not place vinyl, plastic or rubber objects on the instrument, since this might discolor the panel or keyboard.
- In the case of a model with a polished finish, bumping the surface of the instrument with metal, porcelain, or other hard objects can cause the finish to crack or peel. Use caution

## ■ Maintenance

- When cleaning the instrument, use a soft and dry/slightly damp cloth. Do not use paint thinners, solvents, alcohol, cleaning fluids, or chemical-impregnated wiping cloths.
- In the case of a model with a polished finish, gently remove dust and dirt with a soft cloth. Do not wipe too hard since small particles of dirt can scratch the instrument's finish.
- During extreme changes in temperature or humidity, condensation may occur and water may collect on the surface of the instrument. If water is left, the wooden parts may absorb the water and be damaged. Make sure to wipe any water off immediately with a soft cloth.

## ■ Saving data

- Recorded Song and edited Song/Style/Voice/MIDI setup data, etc. are lost when you turn off the power to the instrument. This also occurs when the power is turned off by the Auto Power Off function (page 19). Save the data to the instrument, or to USB flash drive (page 33).
- You can back up the data and settings of this instrument to the USB flash drive as a backup file (page 43), as well as restore a backup file to the instrument. To protect against data loss due to some failure, an operation mistake, etc., save your important data to a USB flash drive (page 43).
- For information about the handling of USB flash drives, refer to page 97.
- To protect against data loss through USB flash drive damage, we recommend that you save your important data onto spare USB flash drive or an external device such as a computer as backup data.

# Information

---

## ■ About copyrights

- Copying of the commercially available musical data including but not limited to MIDI data and/or audio data is strictly prohibited except for your personal use.
- This product incorporates and bundles contents in which Yamaha owns copyrights or with respect to which Yamaha has license to use others' copyrights. Due to copyright laws and other relevant laws, you are NOT allowed to distribute media in which these contents are saved or recorded and remain virtually the same or very similar to those in the product.
  - \* The contents described above include a computer program, Accompaniment Style data, MIDI data, WAVE data, voice recording data, a score, score data, etc.
  - \* You are allowed to distribute medium in which your performance or music production using these contents is recorded, and the permission of Yamaha Corporation is not required in such cases.

## ■ About functions/data bundled with the instrument

- Some of the preset songs have been edited for length or arrangement, and may not be exactly the same as the original.
- This device is capable of using various types/formats of music data by optimizing them to the proper format music data for use with the device in advance. As a result, this device may not play them back precisely as their producers or composers originally intended.
- Supply of this product does not convey a license nor imply any right to distribute content created with this product in revenue-generating broadcast systems (terrestrial, satellite, cable and/or other distribution channels), streaming applications (via Internet, intranets and/or other networks), other content distribution systems (pay-audio or audio-on-demand applications and the like) or on physical media (compact discs, digital versatile discs, semiconductor chips, hard drives, memory cards and the like). An independent license for such use is required. For details, please visit <http://mp3licensing.com>.

## ■ About this manual

- The illustrations and LCD screens as shown in this manual are for instructional purposes only, and may appear somewhat different from those on your instrument.
- iPhone, iPad and iPod touch are trademarks of Apple Inc., registered in the U.S. and other countries.
- The company names and product names in this manual are the trademarks or registered trademarks of their respective companies.

## ■ Tuning

- Unlike an acoustic piano, this instrument does not need to be tuned by an expert (although the pitch can be user-adjusted to match other instruments). This is because the pitch of digital instruments is always maintained perfectly. However, if you feel there is something abnormal concerning the keyboard touch, contact your Yamaha dealer.

### Compatible formats for this instrument

#### ■ GM2

“GM (General MIDI)” is one of the most common Voice allocation formats. “GM System Level 2” is a standard specification that enhances the original “GM” and improves Song data compatibility. It provides for increased polyphony, greater Voice selection, expanded Voice parameters, and integrated effect processing.

#### ■ XG

XG is a major enhancement of the GM System Level 1 format, and was developed by Yamaha specifically to provide more Voices and variations, as well as greater expressive control over Voices and effects, and to ensure compatibility of data well into the future.

#### ■ GS

GS was developed by the Roland Corporation. In the same way as Yamaha XG, GS is a major enhancement of the GM specifically to provide more Voices and Drum kits and their variations, as well as greater expressive control over Voices and effects.

#### ■ XF

The Yamaha XF format enhances the SMF (Standard MIDI File) standard with greater functionality and opened expandability for the future. This instrument is capable of displaying lyrics when an XF file containing lyric data is played.

#### ■ SFF GE (Guitar Edition)

“SFF (Style File Format)” is an original Style file format by Yamaha which uses a unique conversion system to provide high-quality automatic accompaniment based on a wide range of chord types. “SFF GE (Guitar Edition)” is an enhanced format of SFF, which features improved note transposition for guitar tracks.



# About the Manuals

This instrument has the following documents and instructional materials.

## Included Documents

---



### Owner's Manual (this book)

Explains the basic operations of this instrument.



### Data List

Contains various important preset content lists such as Voices, Styles, etc.

## Online Materials (Downloadable from the web)

---



### Reference Manual (only in English, French, German and Spanish)

Explains advanced functions and settings of this instrument.



### iPhone/iPad Connection Manual

Explains how to connect the instrument to smart devices, such as iPhone, iPad, etc.



### Computer-related Operations

Includes instructions on connecting this instrument to a computer.



### MIDI Reference

Contains MIDI-related information of this instrument.

To obtain these manuals, access the Yamaha Downloads, enter the model name for searching the desired files.

#### Yamaha Downloads

<http://download.yamaha.com/>

## Included Accessories

- Owner's Manual (this book)
- Data List
- "50 Greats for the Piano" music book  
Song files (MIDI files) corresponding to the Music Book are available for free downloading over the Internet. To download the Song files, complete the Yamaha Online Member registration and Product registration at the following website.  
<https://member.yamaha.com/myproduct/regist/>
- Online Member Product Registration  
The "PRODUCT ID" on the sheet will be needed when you fill out the User Registration form.
- Warranty\*
- Power Cord
- Bench\*
- USB wireless LAN adaptor\*  
You will need this in order to enable a wireless connection of this instrument to an iPhone or iPad. Refer to page 98 for details.
- Owner's Manual of USB wireless LAN adaptor\*

\* May not be included depending on your area. Check with your Yamaha dealer.

# Contents

PRECAUTIONS.....	5
NOTICE.....	7
Information.....	7
Compatible formats for this instrument.....	8
About the Manuals.....	9
Included Accessories.....	9
<b>Welcome to the World of CVP!</b>	<b>12</b>
<b>Panel Controls</b>	<b>14</b>
<b>Starting Up</b>	<b>16</b>
Opening/Closing the Key Cover.....	16
Using the Music Rest.....	16
Opening/Closing the Lid (CVP-709 Grand Piano type).....	17
Power Supply.....	18
Turning On/Off the Power.....	19
Adjusting the Master Volume.....	20
Using Headphones.....	21
Making Basic Settings.....	22
Changing the Brightness of Display.....	23
<b>Display Structure</b>	<b>24</b>
<b>Basic Operations</b>	<b>26</b>
Display Configuration.....	26
Closing the Current Display.....	28
Display-based Controls.....	29
Calling up the Desired Functions from the Home Display.....	31
Using the ASSIGNABLE Buttons.....	32
File Management.....	33
Entering Characters.....	37
Using the Pedals.....	38
Using the Metronome.....	39
Adjusting the Tempo.....	40
Setting the Touch Sensitivity of the Keyboard.....	40
Transposing the Pitch in Semitones.....	41
Adjusting the Volume Balance.....	42
Restoring the Factory-programmed Settings.....	42
Data Backup.....	43
<b>Piano Room – Enjoying the Piano Performance –</b>	<b>44</b>
Playing a Piano Performance in the Piano Room.....	44
Playing the Piano in Session with Other Instruments.....	45
Changing/Resetting the Piano Room Settings.....	46
Recording your Performance in the Piano Room.....	47
<b>Voices – Playing the Keyboard –</b>	<b>48</b>
Playing Preset Voices.....	48
Setting the Split Point.....	50
Calling up the default Piano Settings (Piano Reset).....	51
Piano Lock Function.....	51
Playing Realistic Resonance-enhanced Piano Sounds (VRM Voices).....	52
Playing Super Articulation Voices.....	53
Creating Original Organ Flutes Voices.....	54
<b>Styles – Playing Rhythm and Accompaniment –</b>	<b>55</b>
Playing with a Style.....	55
Style Control Operations.....	57

Calling up Panel Settings Appropriate for the Current Style (One Touch Setting) .....	60
Searching for Suitable Songs for the Current Style .....	61
Calling up Optimum Styles for Your Performance (Style Recommender) .....	62
Changing the Chord Fingering Type .....	64
<b>Song Playback – Playing and Practice Songs –</b>	<b>66</b>
Playback of Songs .....	66
Displaying Music Notation (Score) .....	69
Displaying Lyrics .....	70
One-handed Practice with the Guide Function .....	70
Repeat Playback .....	72
Adjusting the Pitch in Semitones (Pitch Shift) .....	73
Adjusting the Playback Speed (Time Stretch) .....	74
Canceling the Vocal Part (Vocal Cancel) .....	74
<b>Song Recording – Recording Your Performance –</b>	<b>75</b>
Basic Procedure for Recording (MIDI/Audio Recording) .....	75
Recording to Specified Channels (MIDI Recording) .....	78
Converting a MIDI Song to an Audio Song .....	81
<b>Microphone – Adding Vocal Harmony Effects to Your Singing –</b>	<b>82</b>
Connecting a Microphone .....	82
Applying Vocal Harmony Effects to Your Voice .....	83
<b>Music Finder – Calling up Ideal Panel Setups for Your Performance –</b>	<b>85</b>
Selecting the Desired Record (Panel Settings) .....	85
Searching for Records (Panel Settings) .....	86
<b>Registration Memory – Saving and Recalling Custom Panel Setups –</b>	<b>88</b>
Registering Your Panel Setups .....	88
Saving the Registration Memory as a Bank File .....	89
Recalling a Registered Panel Setup .....	90
<b>Mixer – Editing the Volume and Tonal Balance –</b>	<b>91</b>
Basic Procedure for the Mixer .....	91
Turning Each Channel of the Style or Song On/Off .....	93
<b>Connections – Using Your Instrument with Other Devices –</b>	<b>94</b>
I/O Connectors .....	94
Connecting Audio Devices ([AUX IN] jack, AUX OUT [L/L+R]/[R] jacks) .....	94
Connecting an External Monitor ([RGB OUT] terminal) .....	95
Connecting a Footswitch/Foot Controller ([AUX PEDAL] jack) .....	96
Connecting a Microphone or Guitar ([MIC/LINE IN] jack, [MIC/LINE] switch) .....	96
Connecting USB Devices ([USB TO DEVICE] terminal) .....	97
Connecting to an iPhone/iPad	
([USB TO DEVICE] terminal, [USB TO HOST] terminal and MIDI terminals) .....	98
Connecting to a Computer ([USB TO HOST] terminal) .....	99
Connecting External MIDI Devices (MIDI terminals) .....	99
<b>Menu Display Function List</b>	<b>100</b>
<b>CVP-709 (Grand piano type) Assembly</b>	<b>102</b>
<b>CVP-709 Assembly</b>	<b>105</b>
<b>CVP-705 Assembly</b>	<b>109</b>
<b>Troubleshooting</b>	<b>111</b>
<b>Specifications</b>	<b>115</b>
<b>Index</b>	<b>118</b>

# Welcome to the World of CVP!

This new CVP model is equipped with a convenient touch screen, enabling visual and intuitive control over virtually all instrument functions. Simply by touching this large and easy-to-see display, you can select desired items, enable and control various features, or edit parameter values—with greater ease and speed than ever before!

The instrument also has many advanced features that enhance your musical enjoyment and expand your creative and performance possibilities. Let's take a look...

## True Acoustic Piano Feel

This instrument features gorgeous piano Voices, created with samples of the Yamaha CFX flagship concert grand piano and the famous Bösendorfer\* concert grand piano, as well as a special keyboard to fully reproduce the natural touch response and expressive nuances of an actual concert grand piano, including rapid repetitive capability. Moreover, the instrument features a VRM function which accurately recreates the acoustic resonance of a grand piano, which changes subtly by the timing and strength of the player's touch and pedal operation. This enables expression of even the most delicate performance nuances and responds minutely to your pedal use and key playing.

The new Piano Room features provide even greater piano performance enjoyment. Piano Room lets you select the desired piano type as well as different room ambiences—enabling a complete, realistic piano experience, as if you were playing an actual piano. What's more, you can play along with other virtual “session” players, and enjoy a convincing band-like performance experience with other musical instruments.

\* Bösendorfer is a subsidiary company of Yamaha.

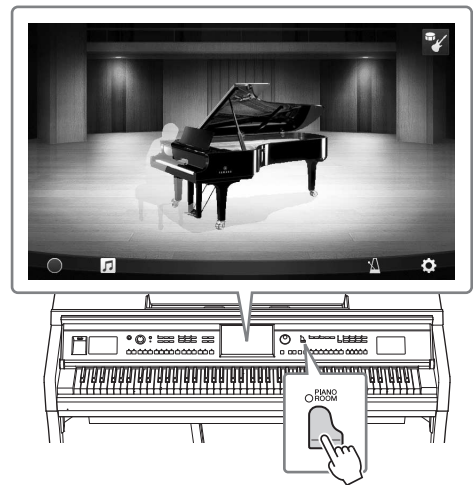

▶▶▶ Page 44

## Play in Various Music Genres

Naturally, the CVP provides many realistic piano Voices for your playing enjoyment. But it also features a wide variety of authentic instruments, both acoustic and electronic, including organ, guitar, sax, and others used in many music genres—letting you convincingly perform in any desired music style. Moreover, the special Super Articulation Voices realistically recreate many of the performance techniques and characteristic sounds generated when an artist plays an instrument. The result is superbly detailed expression—such as the realistic sound of finger slides on guitar, and the expressive breath noises of saxophone and other wind instruments.

▶▶▶ Page 53

## Full Backing Band Accompaniment

Even if you're playing alone, the CVP can put an entire backing band behind you! Simply playing chords automatically triggers and controls the auto accompaniment backing (Style function). Select an accompaniment Style—such as pop, jazz, Latin, and various other music genres in the world—and let the Clavinova be your complete backing band! You can change arrangements on the fly, instantly selecting different rhythm variations and breaks in real time, including Intro, Ending, and Fill-in, during your performance.



Moreover, special Audio Styles (CVP-709 only) have been provided, which feature audio recordings of studio musicians playing in various recording studios worldwide. This adds all the natural feel, ambience and warmth to the drums and percussion of the Style, giving your performance greater expressive potential.

▶▶▶ Page 55

## Enjoyable Song Lesson Features—with Score Display and Guide Lamps

The Lesson features are a fun way to learn and master Songs, with notation shown on the display. Moreover, each key of the keyboard has a Guide lamp, which lights to indicate the notes to be played, letting you practice melodies and phrases smoothly—even if you are a beginner or have trouble reading notation.

▶▶▶ Page 70

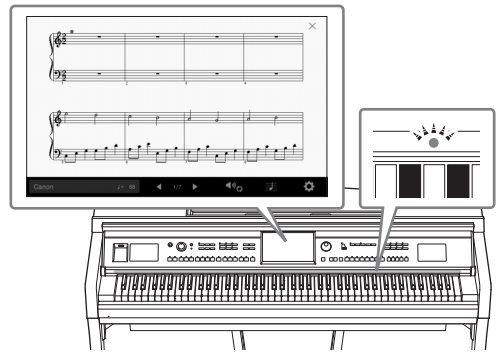

## Sing Along with Song Playback or Your Own Performance

Since a microphone can be connected to the Clavinova and Song lyrics can be shown on the display, you can enjoy singing along with your keyboard performance or along with Song playback. Moreover, a powerful Vocal Harmony effect automatically applies lush, authentic sounding vocal harmonies to your singing voice. You can also cancel the vocal part on audio recordings, letting you sing along with (or instead of!) your favorite artists and groups, and enjoy performing even more.

▶▶▶ Pages 70, 82

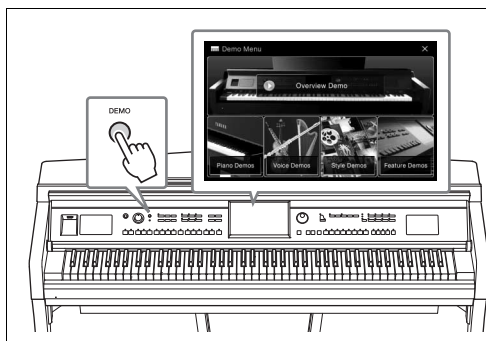

**Want to learn more about the Clavinova's features? Press the [DEMO] button and start the demonstration!**

In the Demo Menu, you can play special Demo Songs or call up brief explanations of the functions of the Clavinova by touching the display.

# Panel Controls

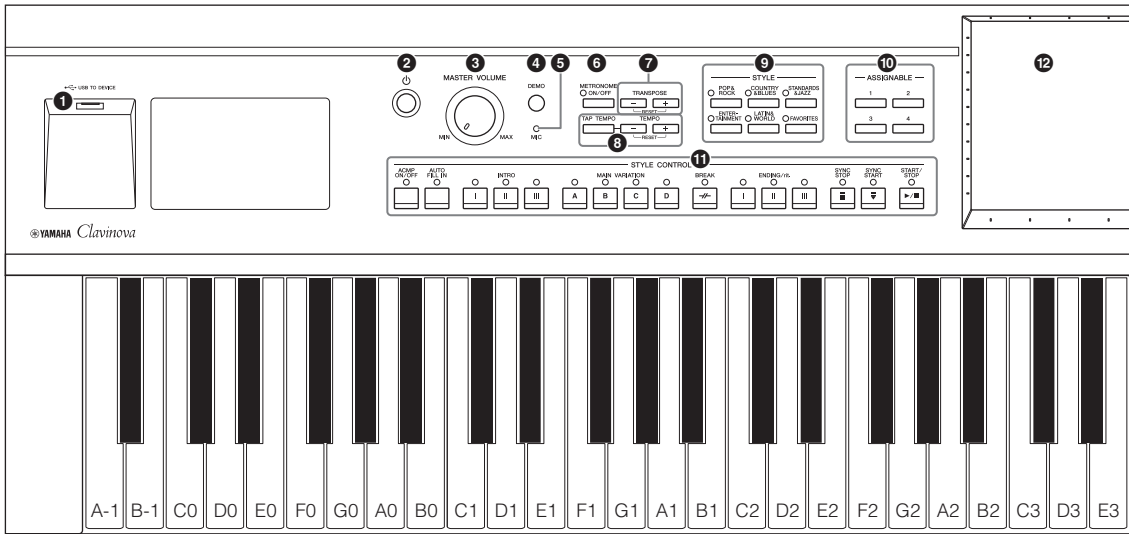

## Panel Setup (Panel Settings)

These settings of the instrument made by using the controls on the panel are together referred to as “panel setup” or “panel settings” in this manual.

- 1 [USB TO DEVICE] terminal** ..... page 97  
For connecting a USB flash drive or USB wireless LAN adaptor.
- 2 [⏻] (Standby/On) switch** ..... page 19  
For turning the power on or setting it to standby.
- 3 [MASTER VOLUME] control** ..... page 20  
For adjusting the overall volume.
- 4 [DEMO] button** ..... page 13  
For calling up the Demo display.
- 5 [MIC] lamp** ..... page 82  
For checking the input level of the microphone.
- 6 [METRONOME ON/OFF] button** .... page 39  
For turning the metronome on or off.
- 7 TRANSPOSE buttons** ..... page 41  
For transposing the pitch in semitone steps.
- 8 [TAP TEMPO]/TEMPO [-]/[+] buttons**  
..... page 40  
For controlling the tempo for Style, MIDI Song and metronome playback.
- 9 STYLE buttons** ..... page 55  
For selecting a Style category.
- 10 ASSIGNABLE buttons** ..... page 32  
For assigning shortcuts to often used functions.
- 11 STYLE CONTROL buttons** ..... page 57  
For controlling Style playback.
- 12 LCD (touch screen)** ..... page 24  
Allows you to select or change the parameters by simply touching the ‘virtual’ buttons or sliders on the display.
- 13 Data Dial** ..... page 30  
For selecting an item or changing the value.
- 14 [HOME] button** ..... page 30  
For calling up the Home display, or the first display when the power is turned on.
- 15 [PIANO ROOM] button** ..... page 44  
For instantly calling up the optimum piano-related settings for playing the instrument simply as a piano, or for playing in a session-like atmosphere with a complete band sound.
- 16 SONG CONTROL buttons** ..... page 68  
For controlling Song playback.
- 17 VOICE buttons** ..... page 48  
For selecting a keyboard part or a Voice category.
- 18 REGISTRATION MEMORY buttons**.... page 88  
For registering and recalling panel setups.
- 19 ONE TOUCH SETTING buttons** ..... page 60  
For calling up the appropriate panel settings for the Style.

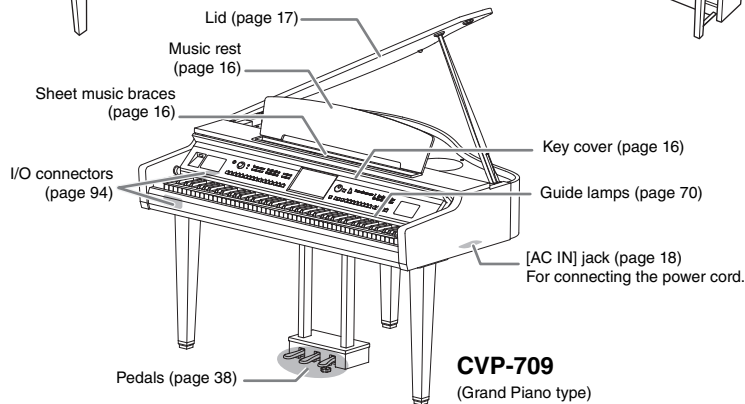
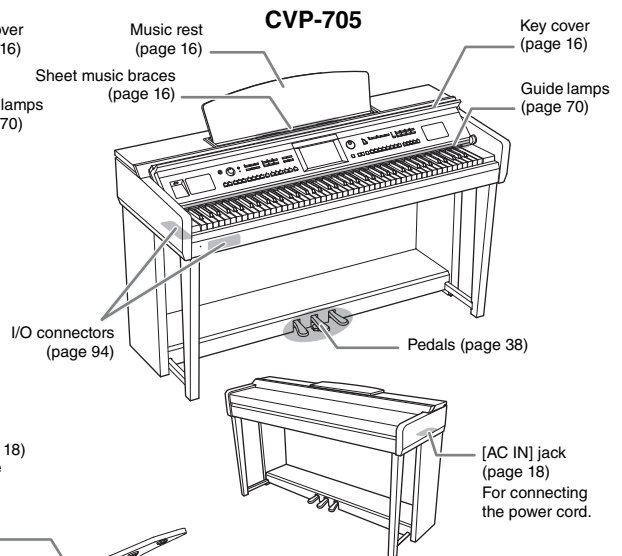
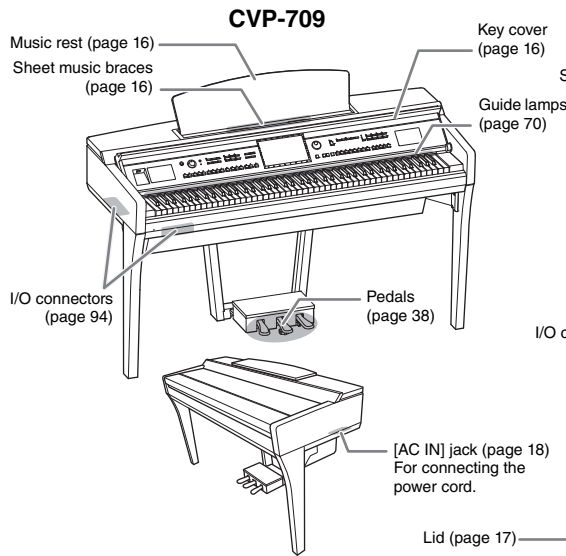
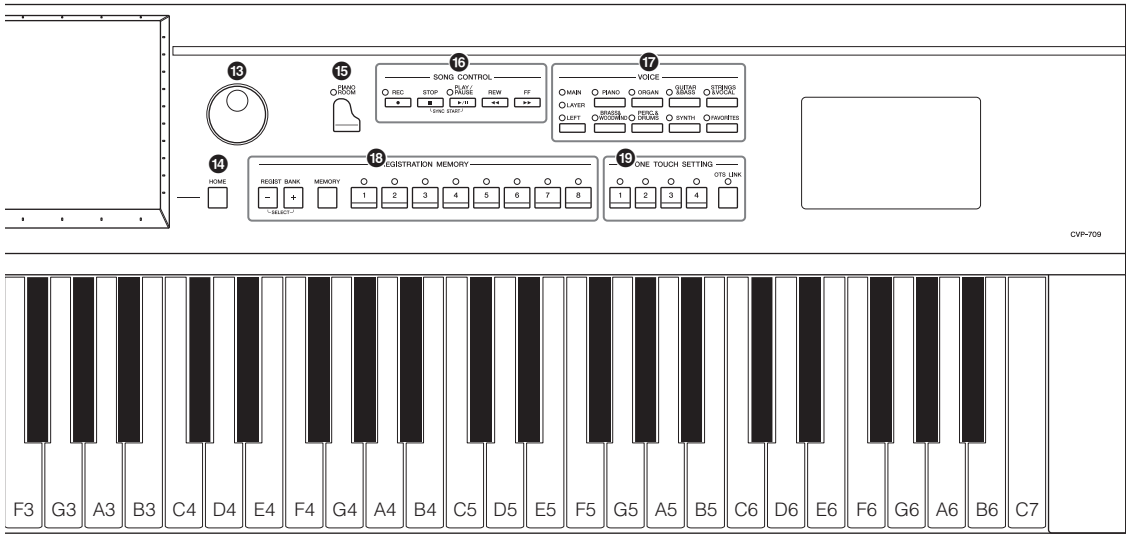

# Starting Up

## Opening/Closing the Key Cover

To open the key cover, hold the hand grip with both hands, then lift the key cover slightly, and push it up and back. To close the key cover, lower the key cover back in place gently with both hands.

### ⚠ CAUTION

- Hold the cover with both hands when opening or closing it. Do not release it until it is fully opened or closed. Be careful to avoid catching fingers (yours or others, especially children's) between the cover and the unit.
- Do not place anything (such as metal objects or pieces of paper) on top of the key cover. Small objects placed on the key cover may fall inside the unit when the cover is opened and may be nearly impossible to remove. Once inside, they could cause electric shock, short circuit, fire or other serious damage to the instrument.

### ⚠ CAUTION

Be careful to avoid catching your fingers when opening/closing the cover.

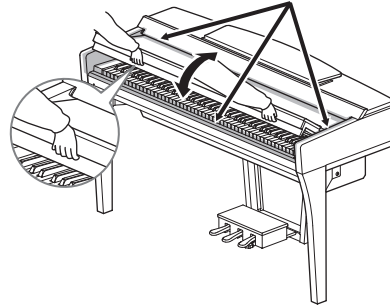

## Using the Music Rest

Pull the music rest toward yourself as far as it will go. When raised, the music rest locks in place at a certain angle and cannot be adjusted. The braces allow you to hold the pages of music books in place.

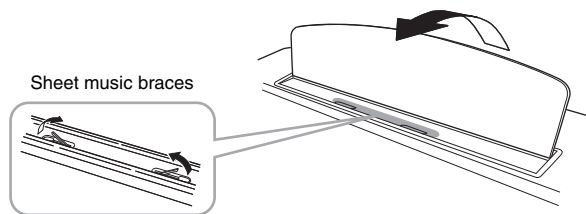

### ⚠ CAUTION

When raising or lowering the music rest, do not release your hands from the music rest until it is all the way up or down.

To lower the music rest, close the sheet music braces, then lift the music rest slightly, and turn it back slowly.

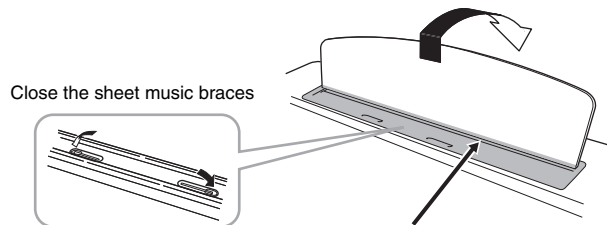

### ⚠ CAUTION

Be careful to avoid catching your fingers.

### ⚠ CAUTION

Before lowering the music rest, close the sheet music braces. Otherwise you may catch your fingers between the music rest and the music braces and injure them.



## Opening/Closing the Lid (CVP-709 Grand Piano type)

One long stay and one short stay are provided on the lid. Use one of them to hold the lid open at the desired angle.

### Opening the Lid

- 1 Raise the music rest.
- 2 Raise and hold the right side of the lid (viewed from the keyboard end of the instrument).
- 3 Raise the lid stay and carefully lower the lid so that the end of the stay fits into the recess in the lid.

#### **CAUTION**

Do not let children open or close the lid. Also, be careful to avoid catching fingers (yours or others, and especially those of children) when raising or lowering the lid.

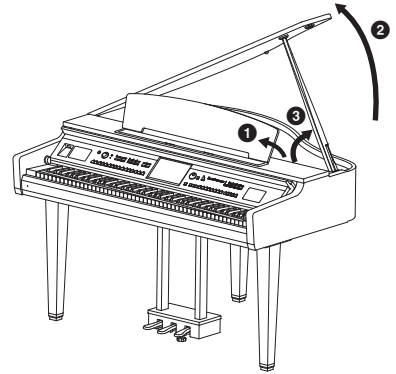

For the longer stay, use the inner recess, and for the shorter stay, use the outer recess to support the lid.

#### **CAUTION**

- Do not use the outer recess for the longer stay. Doing so makes the lid unstable and may cause it to fall, resulting in damage or injury.
- Make sure that the end of the stay fits securely in the lid recess. If the stay is not properly seated in the recess, the lid may fall, causing damage or injury.
- Be careful that you or others do not bump the stay while the lid is raised. The stay may be bumped out of the lid recess causing the lid to fall.

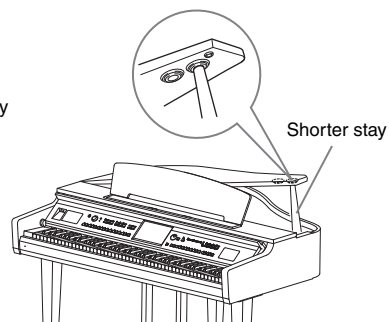
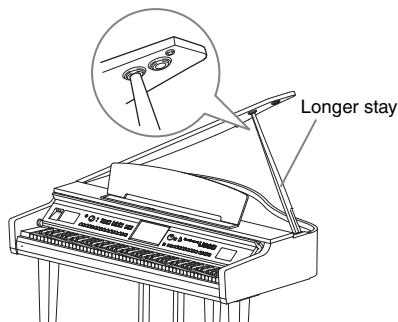

### Closing the Lid

- 1 Hold the lid stay and carefully raise the lid.
- 2 Continue to hold the lid in its raised position and lower the lid stay.
- 3 Carefully lower the lid.

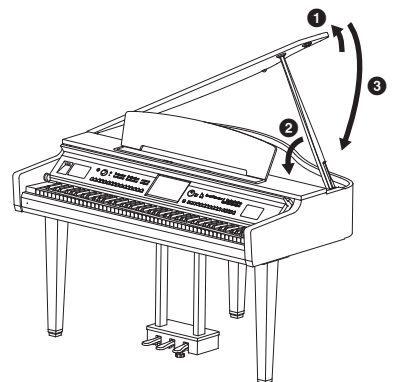

## Power Supply

Connect the plugs of the power cord in the order shown in the illustration.

In some areas a plug adaptor may be provided to match the pin configuration of the AC wall outlets in your area.

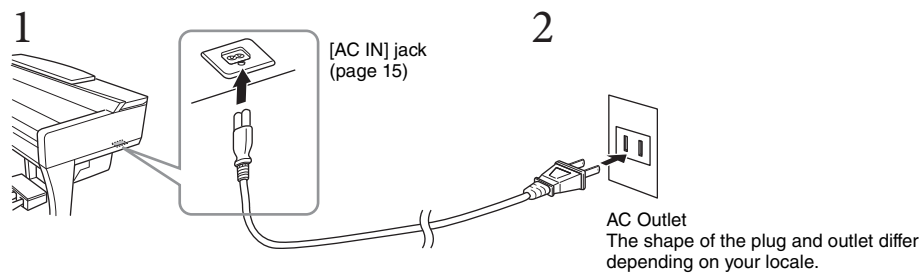

### **⚠ WARNING**

Use only the supplied power cord.

### **⚠ CAUTION**

When setting up the product, make sure that the AC outlet you are using is easily accessible. If some trouble or malfunction occurs, immediately turn off the power switch and disconnect the plug from the outlet.

### **NOTE**

When disconnecting the power cord, first turn off the power, then follow this procedure in reverse order.

## Turning On/Off the Power

1 Turn down the [MASTER VOLUME] dial to “MIN.”

2 Press the [⏻] (Standby/On) switch to turn the power on.

The display and the power indicator located below the left end of the keyboard lights up. Adjust the volume as desired while playing the keyboard.

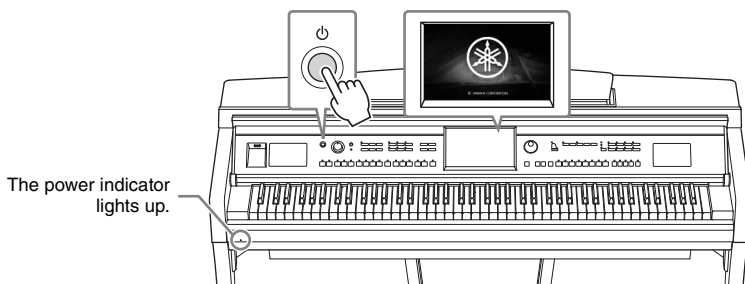
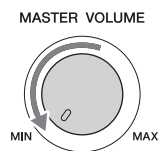

3 Press and hold the [⏻] (Standby/On) switch for about a second to turn the power off.

### ⚠ CAUTION

Even when the [⏻] (Standby/On) switch is in standby status, electricity is still flowing to the instrument at the minimum level. Remove the electric plug from the outlet when the instrument is not to be used for extended periods of time, or during electrical storms.

### NOTICE

While recording or editing, or while a message is displayed, the power cannot be turned off even if you press the [⏻] (Standby/On) switch. If you want to turn off the power, press the [⏻] (Standby/On) switch after recording, editing, or after the message has disappeared. If you need to force-quit the instrument, hold down the [⏻] (Standby/On) switch for longer than three seconds. Note that the force-quit operation might cause data loss and damage to the instrument.

## Auto Power Off function

To prevent unnecessary power consumption, this instrument features an Auto Power Off function that automatically turns the power off if the instrument is not operated for a specified period of time. The amount of time that elapses before the power is automatically turned off is approximately 30 minutes by default; however, you can change the setting (page 22).

### NOTICE

Any data which is not saved via the Save operation will be lost if the power automatically turns off. Make sure to save your data before this happens.

### Disabling Auto Power Off (simple method)

Turn the power on while holding down the lowest key on the keyboard. An “Auto power off disabled” message appears briefly and Auto Power Off is disabled.

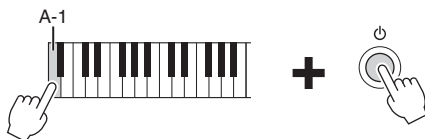

## Adjusting the Master Volume

To adjust the volume of the entire keyboard sound, use the [MASTER VOLUME] dial while playing the keyboard.



### **CAUTION**

Do not use the instrument for a long period of time at a high or uncomfortable volume level, since this can cause permanent hearing loss.

## Intelligent Acoustic Control (IAC)

---

IAC is a function which automatically adjusts and controls the sound quality according to the overall volume of the instrument. Even when the volume is low, it permits both low sounds and high sounds to be clearly heard. IAC Control affects only the sound output of the instrument speakers. The default setting for this function is on. You can turn the IAC setting on or off, and set the depth. For details, refer to the Reference Manual on the website (page 9).

## Using Headphones

Connect a pair of headphones to the [PHONES] jack. Since this instrument is equipped with two [PHONES] jacks, you can connect two pairs of headphones. If you are using only one pair, insert the plug into either of these jacks.

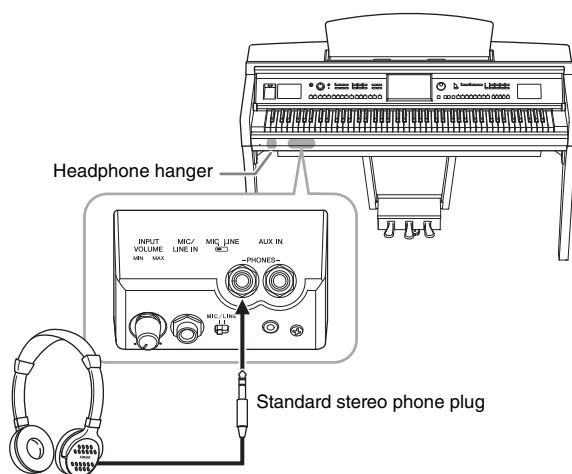

### **CAUTION**

Do not use the headphones for a long period of time at a high or uncomfortable volume level, since this can cause permanent hearing loss.

## Reproducing natural sound distance (Stereophonic Optimizer)

The Stereophonic Optimizer feature recreates for headphones the spacious sensation you hear when you play an acoustic piano. In general, the sound from headphones is much too close to your ears for natural sound. When this function is turned on, you can sense a natural sound distance as if the sound is coming from the piano, even though you hear it on headphones. This function is effective only on the VRM Voices (page 52) and does not affect the sound output of the instrument speakers. The default setting for this function is on, but you can turn it off if desired. For details, refer to the Reference Manual on the website (page 9).

### **NOTE**

If you record a VRM Voice (page 52) with Audio recording (page 75) while this function is on, the Stereophonic Optimizer is applied to the recorded sound.

## Using the Headphone Hanger

A headphone hanger is included in the instrument package so that you can hang the headphones on the instrument. Install the headphone hanger by following the instructions at the end of this manual.

### **NOTICE**

Do not hang anything other than the headphones on the hanger. Otherwise, the instrument or the hanger may be damaged.

## Making Basic Settings

As necessary, make basic settings for the instrument, such as the language shown on the display.

### 1 Call up the operation display (Utility).

First, touch [Menu] at the bottom right corner of the Home display which is shown when the power is turned on. Then touch [▶] to move to page 2 (if necessary), and touch [Utility].

### 2 Touch [System] on the display.

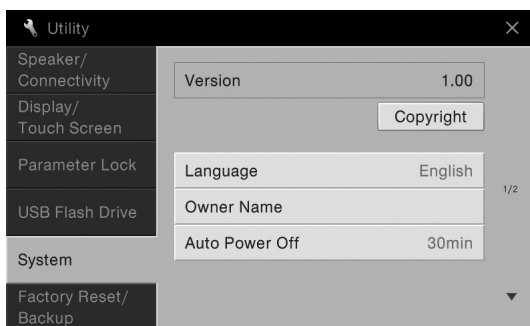

### 3 Make the necessary settings by touching the display.

<b>Version</b>	Indicates the firmware version of this instrument. Yamaha may from time to time update firmware of the product without notice for improvement in functions and usability. To take full advantage of this instrument, we recommend that you upgrade your instrument to the latest version. The latest firmware can be downloaded from the website below: <a href="http://download.yamaha.com/">http://download.yamaha.com/</a>
<b>Copyright</b>	Touch here to call up copyright information.
<b>Language</b>	Determines the language used in the display for menu names and messages. Touch this setting to call up the language list, then select the desired one.
<b>Owner Name</b>	Lets you input your name which appears in the opening display (called up when the power is turned on). Touch this setting to call up the character entry window, then input your name (page 37).
<b>Auto Power Off</b>	Lets you set the amount of time that elapses before the power is turned off by the Auto Power Off function (page 19). Touch this to call up the list of settings, then select the desired one. To disable Auto Power Off, select “Disabled” here.

# Changing the Brightness of Display

Here you can change certain display settings as desired, including brightness.

- 1 Call up the operation display (Utility) (step 1 on page 22).
- 2 Touch [Display/Touch Screen] on the display.

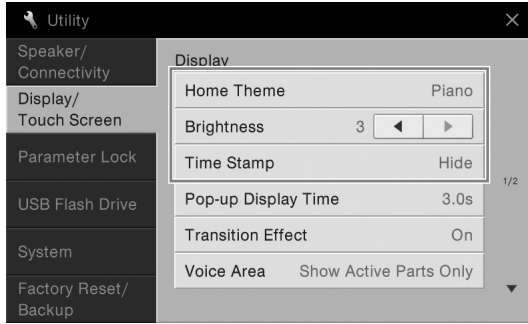

- 3 Change the settings by touching the display.

<b>Home Theme</b>	Touch and change the theme (background) of the Home display. The available settings are Piano/White/Black.
<b>Brightness</b>	Touch [◀]/[▶] to adjust the brightness of the display.
<b>Time Stamp</b>	Determines whether the time stamp of a file is shown on the User tab of the File Selection display (page 27) or not. <b>NOTE</b> When the instrument is connected to a network via the USB wireless LAN adaptor*, the current time is taken from the network and displayed. For details, refer to the Reference Manual on the website (page 9). * A USB wireless LAN adaptor may not be included depending on your area.

For information on the other items in this display, refer to the Reference Manual on the website (page 9).

# Display Structure

Turning on this instrument calls up the Home display, from which you can call up the File Selection display and Menu display, providing you convenient access to various functions and allowing you to make various settings. For detailed instructions on the display, refer to page 26.

## File Selection display

You can call up the desired type of display by touching the Style name, Voice name or Song name on the Home display.

## Style Selection display

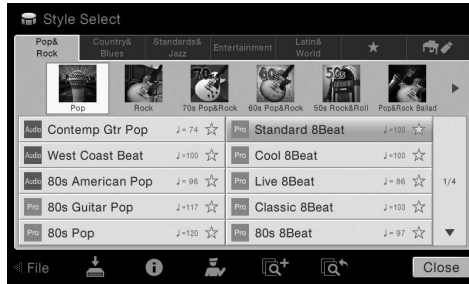

## Voice Selection display

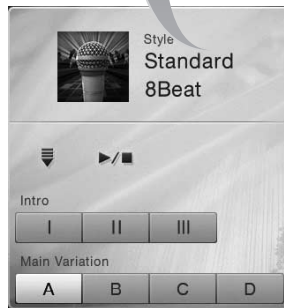

By expanding the Style area, you can call up the playback-related controls on the display.



## Home display

This is the portal or home base of the instrument's display structure.

## Menu display

By touching each of the icons, you can call up various functions, such as Song Score, Volume Balance and other detailed settings.





### Song Selection display

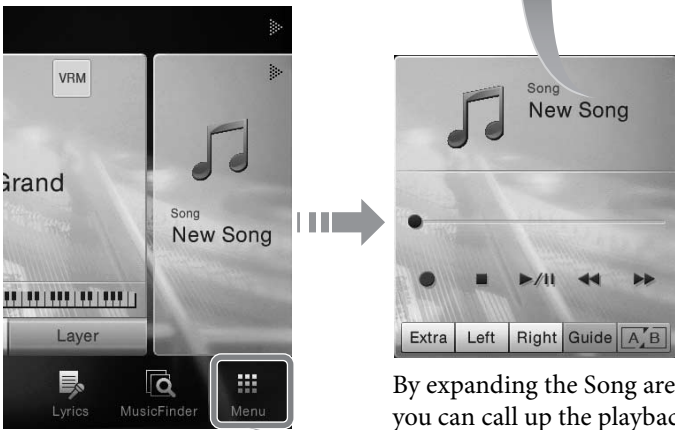
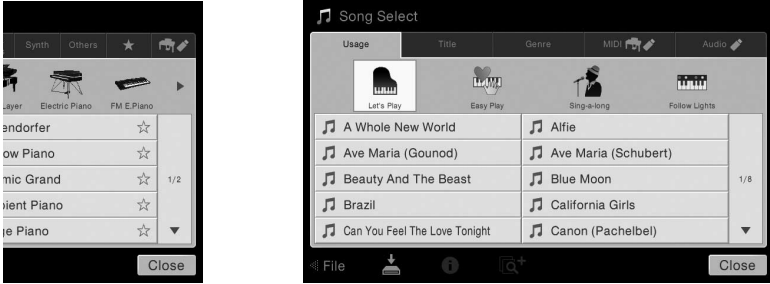

By expanding the Song area, you can call up the playback-related controls on the display.

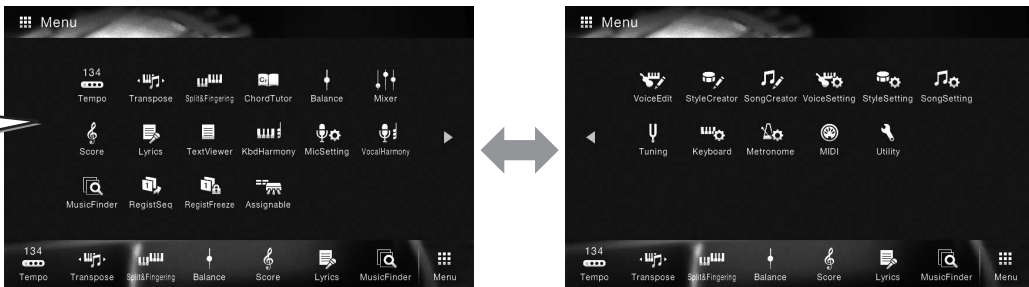

# Basic Operations

## Display Configuration

This section covers the most often used displays: Home, File Selection and Menu. The Home display appears when the power is turned on. The File Selection display and Menu display can be called up from the Home display.

### Home Display

Appears when the power is turned on, and can be called up when the [HOME] button is pressed. This display shows the current basic settings such as the current Voice and Style, allowing you to see them at a single glance. Because of this, you should normally have the Home display shown when you perform on the keyboard.



#### 1 Voice area

Indicates the current Voices for each of the keyboard parts (Main, Left and Layer) and the on/off status of these parts (page 48). Touching a Voice name calls up the Voice Selection display.

##### NOTE

On the Voice area, Style area or Song area, flicking right expands the Style area, while flicking left expands the Song area.

#### 2 Style area

Indicates the current Style (page 55). Touching a Style name calls up the Style Selection display. Touch [◀] at the upper left of this area to expand the area. To reset the area to the default status, touch [▶], which appears at the upper right of the Voice area.

#### 3 Song area

Indicates the current Song (page 66). Touching a Song name calls up the Song Selection display. Touch [▶] at the upper right of this area to expand the area. To reset the area to the default status, touch [◀], which appears at the upper left of the Voice area.

#### 4 Registration area

Indicates the currently selected Registration Memory Bank name, Registration name and Registration Sequence when it is active (page 88). Touching this area calls up the Registration Bank Selection display. You can hide or show this area by touching [◀] or [▶] in the area.

##### NOTE

Flicking right or left on the Registration area can also hide or show this area.

## 5 Menu area

Contains the shortcut icons which let you call up various functions with a single touch. Touching a shortcut icon will call up the display of the corresponding function. Touch [Menu] icon at the right end to call up the Menu display, from which you can register shortcut icons as desired here (page 31).



## File Selection Display

The File Selection display is for selecting a Voice, Style, Song, and other data. You can call up this display by touching the name of the Voice, Style or Song on the Home display, or by pressing one of the VOICE or STYLE buttons, etc.



## 1 Category

A wide variety of data such as Voices and Styles are divided into several categories (tabs) according to the data type. Except for the following two, all tabs are referred to as “preset” tabs, since they contain preset data.

 (Favorite tab)	Location where the Voices or Styles which you have registered as Favorites are shown (page 36). This tab is available only for Voices and Styles.
 (User tab)	Location where recorded or edited data is saved. Data saved to the instrument are shown in “USER” (User memory), while data in the connected USB flash drive are shown in “USB.” In this manual, data in the User tab is referred to as “User data.”

## 2 Sub Category / Folder (Path)

- When one of the preset tabs is selected, the sub categories are shown here according to the data type. For example, various piano types such as Grand Piano and Electric Piano are shown when you touch the “Piano” tab on the Voice Selection display.
- When the Favorite tab is selected, this is not available.
- When the User tab is selected, the current path or folder is shown here according to the folder structure.



## 3 Selectable data (files)

The files that can be selected are shown. If two or more pages are available, you can call up another page by touching [▲] or [▼] at the right.

### NOTE

You can call up another page also by flicking vertically on the list.

## 4 Operation icons

The functions (save, copy, delete, etc.) which can be operated via the File Selection display are shown. The icons shown here differ depending on which File Selection display is selected. For detailed instructions, refer to pages 33 – 37, or the instructions for each function's File Selection display.

## Menu Display

This is the portal display for using various functions and can be called up by touching the [Menu] icon at the bottom right corner of the Home display.

### NOTE

You can call up the Menu display also by flicking upward from the bottom on the Home display. Flicking downward on the Menu display calls up the Home display.



## 1 Functions

Various convenient functions are shown via icons. Touching each of them calls up the corresponding function. This list consists of two pages, which you can select by pressing [▶] or [◀].

For information on each function, refer to the “Menu Display Function List” (page 100) or the Reference Manual on the website (page 9).

### NOTE

You can also change pages by flicking horizontally.

## 2 Shortcuts

By registering often used functions here as Shortcuts, you can call up them quickly from the Home display. For instructions, refer to page 31.

### Instruction conventions for the Menu display

Throughout this manual, instructions with multiple steps are given in convenient shorthand, with arrows indicating the proper sequence.

Example: [Menu] → [Utility] → [System] → [Language]

The example above describes a three step operation:

- 1) From the Menu display, touch [Utility].
- 2) Touch [System].
- 3) Touch [Language].

## Closing the Current Display

To close the current display, touch [×] at the upper right of the display (or window) or [Close] at the lower right of the display (or window). When a message (information or confirmation dialog) appears, touching the appropriate item such as “Yes” or “No” closes the message.

If you want to quickly return to the Home display press the [HOME] button on the panel.

# Display-based Controls

The display of this instrument is a special touch screen that allows you to select or change the desired parameter by simply touching the corresponding setting on the display.



## Using the Display (Touch Screen)

### NOTICE

Do not use any sharp or hard tools to operate the touch screen. Doing so may damage the display.

### NOTE

Keep in mind that operation by simultaneously touching two or more points on the display is not possible.

### Touch

To select an item, lightly touch the corresponding indication on the display.

### NOTE

You can turn on/off system sounds produced when touching the display from [Menu] → [Utility] → [Display/Touch Screen] → Touch Screen [Sound]

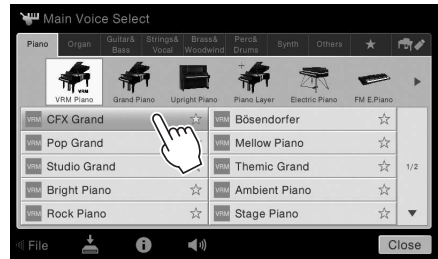

### Slide

Hold down the display slider, then slide your finger vertically or horizontally to change the parameter value.

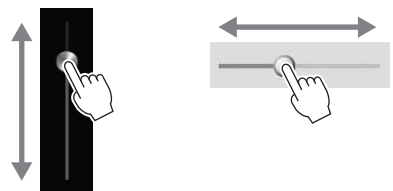

Slide your finger vertically or horizontally on the display to turn pages, or to show or hide some part of a particular display.

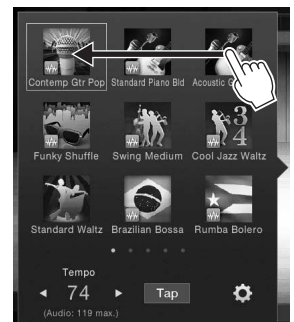

## ■ Rotate

Touch and hold the display knob, and rotate your finger around the knob to change the parameter value.

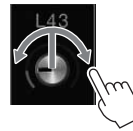

## ■ Touch and hold

This instruction means to touch the object in the display and hold it for a while.

When setting values by using [◀]/[▶], a slider or a knob, you can restore the default value by touching and holding the value on the display.

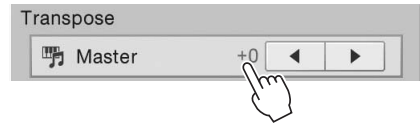

## Rotating the Data Dial

Depending on the display, the Data dial can be used in the following two ways.

### ■ Adjusting the parameter values

After selecting the desired parameter, use the Data dial to adjust the value. This is useful if you have difficulty adjusting by touching on the display, or want finer control over the adjustment.

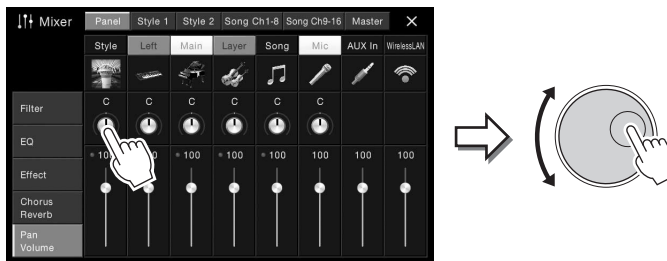

### ■ Selecting an item from a list

In File Selection displays (page 27) and the List windows for setting parameters, use the Data dial to select an item.

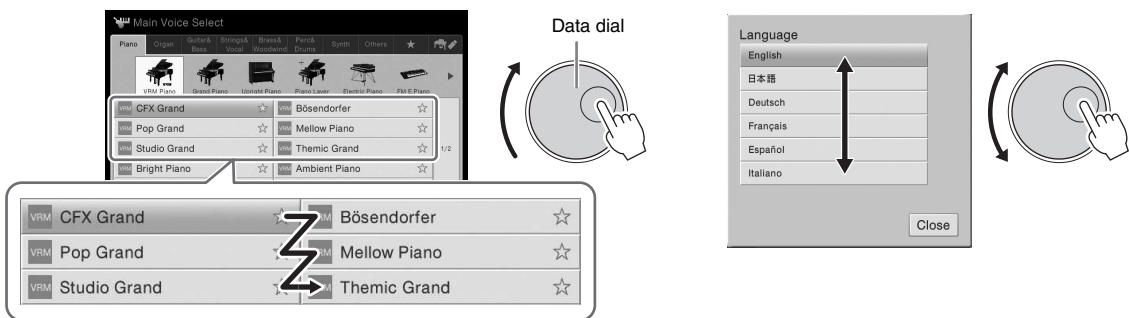

## Pressing the [HOME] Button

You can quickly return to the Home display (the display shown when the power is turned on) by pressing the [HOME] button whenever you want.



## Calling up the Desired Functions from the Home Display

From all the functions shown on the Menu display, you can pick out an often used one and register it to a shortcut. Registered shortcuts are shown in the Menu area (page 27) at the bottom of the Home display, allowing you to quickly call up the desired function from the Home display.

### Replacing a Shortcut on the Home Display

Although seven shortcuts are registered by default, you can customize them as necessary.

- 1 Touch and hold the icon of the desired function until the color of the shortcut area (bottom of the display) changes.

**NOTE**

To cancel this operation, touch any blank location on the display before going on to step 2.



- 2 From the seven locations at the bottom of the display, touch the one you want to replace.

The function selected in step 1 will be registered, replacing the one selected here.

### Moving a Shortcut

- 1 Touch and hold the desired icon until the color changes.

**NOTE**

To cancel this operation, touch any blank location on the display before going on to step 2.

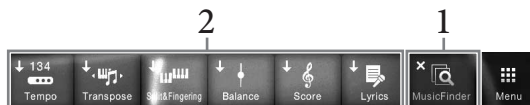

- 2 From the seven locations, touch the desired destination icon.

The icons touched in steps 1 and 2 are switched.

## Deleting a Shortcut

### 1 Touch and hold the desired icon until the color changes.

#### NOTE

To cancel this operation, touch any blank location on the display before going on to step 2.



### 2 Touch the same icon again to delete it from the shortcuts.

## Using the ASSIGNABLE Buttons

You can assign the functions which you use frequently to these four panel buttons at the left side of the display. Also, any of the functions listed on the Menu display can be assigned here as a shortcut.

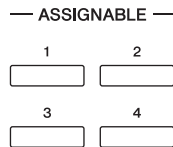

### 1 Call up the operation display via [Menu] → [Assignable] → [Assignable].

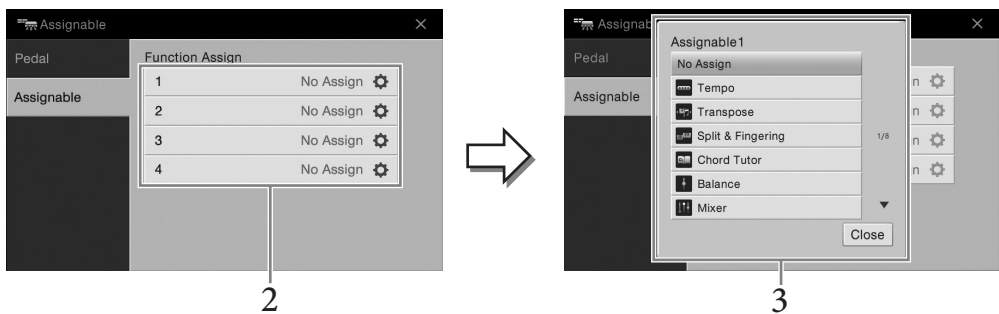

### 2 Touch the desired button number to call up the list.

### 3 Select the desired item from the functions and shortcuts (equivalent to the functions in the Menu display).

#### NOTE

For details about the functions which can be assigned to these buttons, refer to the Reference Manual on the website (page 9).



## File Management

Data you have created such as recorded Song and edited Voice can be saved as files to the instrument (referred to as “User memory”) and a USB flash drive. If you’ve saved a lot of files, you may have trouble finding the desired file quickly. To make operation easier, you can organize your files in folders, rename the files, delete unnecessary files, etc. These operations are done in the File Selection display.

### NOTE

Before using a USB flash drive, be sure to read “Connecting USB Devices” on page 97.

## Saving a File

You can save your original data (such as Songs you’ve recorded and Voices you’ve edited) as a file to the instrument or USB flash drive.

1 In the relevant display, touch  (Save) to call up the display for selecting the saving destination.

2 Select the location to which you want to save the file.

To show the next higher level folder, touch  (Above).

You can create a new folder by touching  (New Folder).

### NOTE

Files of edited Audio Styles (CVP-709 only; page 57) can be saved only in the User memory of the instrument.



3 Touch [Save here] to call up the Character Entry window.

### NOTE

To cancel this operation, touch [Cancel].

4 Enter the file name (page 37).

Even if you skip this step, you can rename the file at any time (page 34) after saving.

5 Touch [OK] in the Character Entry window to actually save the file.

The saved file will be automatically located at the appropriate position among the files in alphabetical order.

## Creating a New Folder

Folders can be created, named and organized as desired, making it easier to find and select your original data.

### NOTE

- In User memory, no more than three folder levels can be created. The maximum total number of files/folders which can be saved differs depending on the file size and the length of the file/folder names.
- The maximum number of files/folders which can be stored in a folder is 500.

### 1 In the File Selection display, touch the User tab (page 27) then select the location to which you want to create a new folder.

To show the next higher level folder, touch  (Above).

### NOTE

You cannot create a new folder in the "Piano Room" folder.

### 2 Touch [File] to call up the File Management icons.

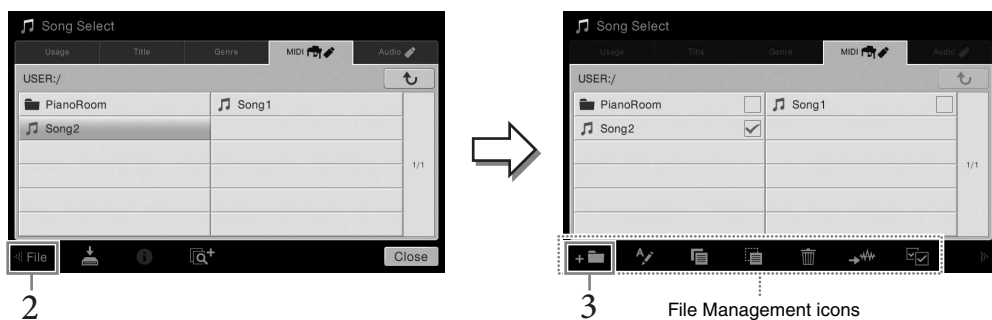

### NOTE

- To cancel the file operation, touch [▶] at right corner to hide the File Management icons.
- You can hide or show the File Management icons by flicking the bottom of the display horizontally.

### 3 Touch (New Folder) to call up the Character Entry window.

### 4 Input the name of the new folder (page 37).

## Renaming a File/Folder

You can rename files/folders.

### NOTE

- Files in the Preset tabs cannot be renamed.
- The "Piano Room" folder cannot be renamed.

### 1 Call up the File Selection display, on which the desired file/folder is shown.

### 2 Touch [File] to call up the File Management icons.

### NOTE

- To cancel the file operation, touch [▶] at right corner to hide the File Management icons.
- You can hide or show the File Management icons by flicking the bottom of the display horizontally.

### 3 Enter a checkmark to the desired file or folder by touching it.

### 4 Touch (Rename) to call up the Character Entry window.

### NOTE

Only one file or folder can be renamed at a time.

### 5 Input the name of the selected file or folder (page 37).

## Copying or Moving Files

---

You can copy or cut a file and paste it to another location (folder). You can also copy a folder (but not move it) by using the same procedure.

### NOTE

- Files in the Preset tabs cannot be moved.
- Copying of commercially available musical data including but not limited to MIDI data and/or audio data is strictly prohibited except for your personal use. Commercially available Song data may be copy protected to prevent illegal copying or accidental erasure.
- Audio Styles (CVP-709 only; page 57) can be copied only to the User memory of the instrument.
- Some of the files recorded in Piano Room with accompaniment cannot be copied, depending on the type of accompaniment.
- Files recorded in the Piano Room (page 44) with Audio Styles cannot be copied.



**1 Call up the appropriate File Selection display, on which the desired files/folders are shown.**

**2 Touch [File] to call up the File Management icons.**

### NOTE

- To cancel the file operation, touch [▶] at right corner to hide the File Management icons.
- You can hide or show the File Management icons by flicking the bottom of the display horizontally.

**3 Enter checkmarks to the desired files/folders by touching each item.**

One or more files/folders can be checked. When you want to enter checkmarks to all displayed items, touch  (Check All). Touch  (Check All) again to remove all the checkmarks.

**4 Touch  (Copy) or  (Move), to call up the display for selecting the destination.**

**5 Select the desired destination (path) to paste the files/ folders.**

You can create a new folder by touching  (New Folder).

### NOTE

To cancel this operation, touch [Cancel] before going to step 6.

**6 Touch [CopyHere] or [MoveHere] to paste the files/folders you've selected in step 3.**

The pasted file/folder appears on the display at the appropriate position among the files in alphabetical order.

## Deleting Files/Folders

---

You can delete files/folders.

### NOTE

- Files in the Preset tabs cannot be deleted.
- The "Piano Room" folder cannot be deleted.



**1 Call up the appropriate File Selection display, on which the desired files/folders are shown.**

**2 Touch [File] to call up the File Management icons.**

### NOTE

- To cancel the file operation, touch [▶] at right corner to hide the File Management icons.
- You can hide or show the File Management icons by flicking the bottom of the display horizontally.

**3 Enter checkmarks to the desired files/folders by touching each item.**

One or more files/folders can be checked. When you want to enter checkmarks to all displayed items, touch  (Check All). Touch  (Check All) again to remove all the checkmarks.

**4 Touch  (Delete).**

**5 After the confirmation message appears, touch [Yes] to actually delete the files/folders you've selected in step 3.**

To cancel this operation, touch [No] instead of [Yes].

## Registering Files to the Favorite Tab

You can call up your favorite or often used Voices or Styles quickly by registering them to the Favorite tab. Touch the star mark (☆) at the right side of each file to register the corresponding file to the Favorite tab. To remove the registered file from the Favorite tab, touch the colored star mark (★) in the Favorite tab or in the tab which actually contains the corresponding file.

### NOTE

- If you change the name of the original file or move/delete the original file, touching the corresponding file name in the Favorite tab cannot call up the file.
- Within the Favorite tab, to actually remove the file, you need to touch the colored star then close or switch the display.



## Sorting the File Order in the Favorite Tab

You can change the order of the files such as Voices and Styles in the Favorite tab.

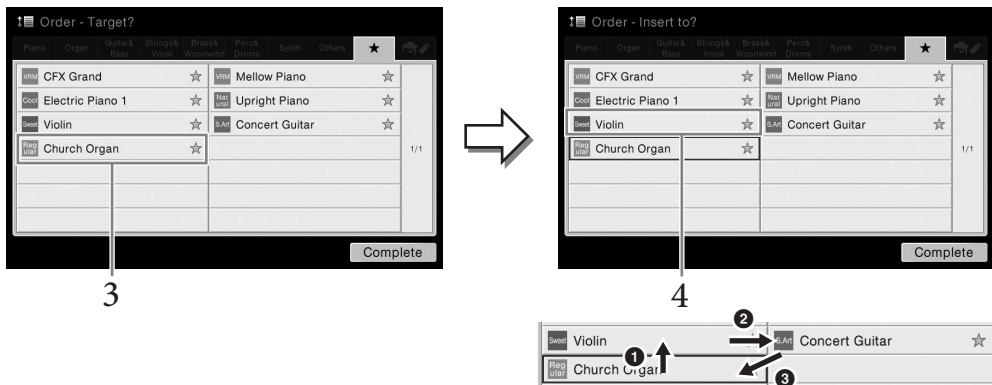

- 1 In the Voice Selection display or Style Selection display, touch the Favorite tab.
- 2 Touch (Order) to call up the Order Edit display.
- 3 Touch the file you want to move.



- 4 Touch the location to which you want to move the file selected in step 3.
- 5 Repeat steps 3 - 4 as necessary.
- 6 Touch [Complete] to exit from the Order Edit display.

## Restrictions for protected Songs

Commercially available Song data may be copy protected to prevent illegal copying or accidental erasure. They are marked by the indications at the left side of the file names. The indications and relevant restrictions are detailed below.

-  (gray) **Protected 1:** Indicates Preset Songs saved to the “USER” (User memory) and Disklavier Piano Soft Songs. These cannot be copied/moved/saved to external devices.
-  (yellow) **Protected 2 Original:** Indicates Yamaha-protection-formatted Songs. These cannot be copied. These can be moved/saved only to the “USER” (User memory) and USB storage devices with ID.
-  (yellow) **Protected 2 Edited:** Indicates edited “Protected 2 Original” Songs. These cannot be copied. These can be moved/saved only to the “USER” (User memory) and USB storage devices with ID.

### Note for “Protected 2 Original” and “Protected 2 Edited” Song file operation

Make sure to save the “Protected 2 Edited” Song to the same folder containing its original “Protected 2 Original” Song. Otherwise the “Protected 2 Edited” Song cannot be played back. Also, if you move a “Protected 2 Edited” Song, be sure to move its original “Protected 2 Original” Song to the same location (folder) at the same time.

## Entering Characters

This section covers how to enter characters for naming your files/folders, inputting keywords on Music Finder (page 85), etc. Entering characters is done in the display shown below.



### 1 Touch the character type.

#### ■ When the Language (page 22) is set to other than Japanese:

Touching [Symbol] (or [abc]) switches between entering symbols or Roman letters (and numbers).

To switch between entering capital letters or small letters, touch  (Shift).

#### ■ When the Language (page 22) is set to Japanese:

- a b c (全角 abc): Roman letters and numbers in half size (full size)
- 記号 (全角記号): Symbols in half size (full size)
- カナ (半角かな): Katakana in full size (half size)
- かな漢: Hiragana and Kanji

To switch between full size or half size, touch and hold the Character Type. For example, [半角かな] can be called up by holding [カナ].

When entering Roman letters, you can switch between capital and small letters by touching  (Shift).

### 2 Touch []/[] or rotate the Data dial to move the cursor to the desired location.

### 3 Input the desired character one by one.

To delete a single character, touch [Delete]; to delete all characters at once, touch and hold [Delete]. To enter a space, touch the space key indicated in the illustration on the previous page.

#### NOTE

- Depending on the display for character entry you are working in, some types of characters cannot be entered.
- A file name can contain up to 46 characters and a folder name can contain up to 50 characters.
- The following characters (half size) cannot be used: \ / : \* ? " < > |

#### ■ To input letters with auxiliary symbols (when Language is set to other than Japanese):

You can input letters with auxiliary symbols such as umlaut by touching and holding a letter to call up a list. For example, touch and hold “E” to enter “Ë” from the list.

#### ■ To convert into Kanji (when the Language is set to Japanese):

When the entered “hiragana” characters are shown in reverse display (highlighted), touch [変換] several times to call up the conversion options. You can change the reversed area by touching [◀] or [▶]. When you find the desired Kanji, touch [確定].

To change the converted kanji back to “hiragana,” touch [戻す].

To clear the reversed area at once, touch [キャンセル].

#### NOTE

To cancel this operation, touch [Cancel] before going on to step 4.

### 4 Touch [OK] to finalize the characters (name, keywords, etc.) you have input.

## Using the Pedals

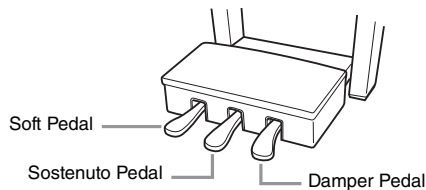

#### NOTE

If the pedal box rattles or gives way when you step on the pedals, turn the adjuster so that it is set firmly against the floor (pages 104, 107, 110).

#### ■ Damper Pedal (Right)

Pressing this pedal sustains notes. Releasing this pedal immediately stops (damps) any sustained notes. Pressing this pedal while you play a VRM Voice (page 52) recreates the characteristic string resonance of a real acoustic piano. A “half-pedal” function of this pedal creates partial sustain effects, depending on how far down you press the pedal.

#### NOTE

- Certain Voices, such as strings and brass, sustain continuously when the damper/sostenuto pedal is pressed.
- Certain Voices such as drum kits may not be affected by use of the damper/sostenuto pedal.

#### Half-pedal function

This function allows the sustain length to vary depending on how far the pedal is pressed. The farther you press the pedal, the more the sound sustains. For example, if you press the damper pedal and the notes you play sound a bit murky and loud with too much sustain, you can partially release the pedal to lessen the sustain (murkiness).

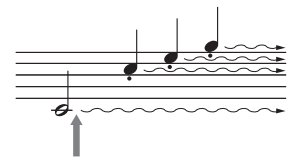

If you press and hold the damper pedal here, all the notes shown will be sustained.

### GP Responsive Damper Pedal (CVP-709 only)

This special pedal has been designed to provide enhanced tactile response and, when pressed, is much closer in feel to the pedal of an actual grand piano. It makes it easier to physically experience the half-pedal point and more easily apply the half-pedal effect than other pedals.

Since the pressing sensation may vary depending on the situation, including the location where the instrument is installed, you can adjust the half-pedal point to the desired setting on the display called up via [Menu] → [Assignable] → [Pedal]. For details, refer to the Reference Manual on the website (page 9).

#### NOTE

The pedals are fitted with covers when shipped from the factory. Remove the cover from the pedals for optimum use of the GP Responsive Damper Pedal's effect.

### ■ Sostenuto Pedal (Center)

When the Piano Voice is selected, if you play a note or chord on the keyboard and press this pedal while holding the note(s), the notes will sustain as long as the pedal is held. All subsequent notes will not sustain.

When a Voice other than piano is selected, a specific function appropriate for the Voice is automatically assigned to the center pedal.



If you press and hold the sostenuto pedal here, only the notes held at this timing will be sustained.

### ■ Soft Pedal (Left)

When the Piano Voice is selected, pressing this pedal reduces the volume and slightly changes the timbre of the notes you play. When a Voice other than piano is selected, a specific function appropriate for the Voice is automatically assigned to the left pedal.

You can adjust the depth of the Soft pedal effect on the display called up via [Menu] → [Assignable] → [Pedal]. For details, refer to the Reference Manual on the website (page 9).

### Assigning a function to each pedal

Various functions can be assigned to each of the three pedals and a foot controller/footswitch (sold separately) — including start/stop of Song playback and controlling a Super Articulation Voice. These can be set on the display called up via [Menu] → [Assignable] → [Pedal]. For details, refer to the Reference Manual on the website (page 9).

## Using the Metronome

The [METRONOME ON/OFF] button lets you start or stop the metronome. The metronome provides a click sound, giving you an accurate tempo guide when you practice, or letting you hear and check how a specific tempo sounds.

#### NOTE

You can also change the time signature, volume and sound of the metronome on the display called up via [Menu] → [Metronome] → [Metronome].

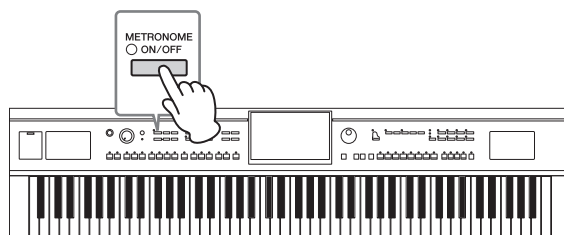

## Adjusting the Tempo

The TEMPO [-] and [+] buttons let you change the playback tempo of Metronome, Style and MIDI Song. The tempo of the Style and MIDI Song can also be adjusted via the [TAP TEMPO] button.

### NOTE

If you want to adjust the tempo of an Audio Song, use the Time Stretch function on page 74.

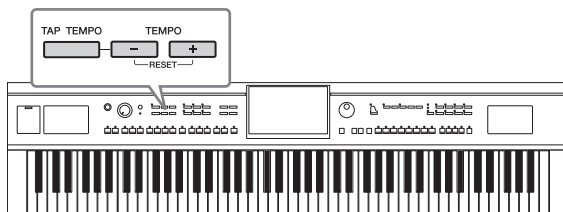

### ■ TEMPO [-]/[+] buttons

Press the TEMPO [-] or [+] button to call up the Tempo pop-up display. Use the TEMPO [-]/[+] buttons to decrease or increase the tempo over a range of 5 – 500 beats per minute. Holding down either button changes the value continuously. Pressing both TEMPO [-] and [+] buttons calls up the default tempo of the last selected Style or Song.

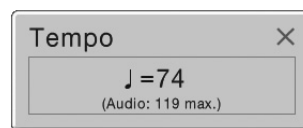

When you select an Audio Style (CVP-709 only; page 57), the upper limit of the tempo will be shown below the tempo value. The Audio part is muted if the tempo is over the upper limit.

### ■ [TAP TEMPO] button

During playback of a Style or MIDI Song, you can change the tempo by tapping the [TAP TEMPO] button twice at the desired tempo. When Style and Song are stopped, tapping the [TAP TEMPO] button (four times for a 4/4 time signature) starts playback of the rhythm part of the Style at the tempo you tapped.

## Setting the Touch Sensitivity of the Keyboard

Touch Sensitivity determines how the sound responds to your playing strength. This setting does not change the weight of the keyboard.

### 1 Call up the display via [Menu] → [Keyboard].

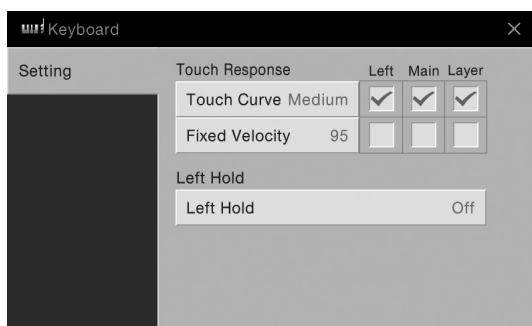



## 2 Make the settings by touching the display.

<p><b>Touch Curve</b></p>	<p>Enter checkmarks to the boxes of the desired keyboard parts, then touch here to call up the setting window and select the Touch Sensitivity type. If you remove the checkmark, playing the corresponding part will produce a fixed velocity regardless of your playing strength.</p> <p><b>NOTE</b> The Touch Sensitivity settings may have no effect with certain Voices.</p> <ul style="list-style-type: none"> <li>• <b>Hard2:</b> Requires strong playing to produce high volume. Best for players with a heavy touch.</li> <li>• <b>Hard1:</b> Requires moderately strong playing for high volume.</li> <li>• <b>Medium:</b> Standard Touch Sensitivity.</li> <li>• <b>Soft1:</b> Produces high volume with moderate playing strength.</li> <li>• <b>Soft2:</b> Produces relatively high volume even with light playing strength. Best for players with a light touch.</li> </ul>
<p><b>Fixed Velocity</b></p>	<p>Make sure that the box of the desired keyboard parts are checked, then touch here to call up the setting window and set the velocity with which you play the keys, which stays fixed regardless of your playing strength.</p>

For details on the Left Hold function, refer to page 51.

## Transposing the Pitch in Semitones

The TRANSPOSE [-]/[+] buttons transpose the overall pitch of the instrument (the keyboard sound, Style playback, MIDI Song playback, and so on) in semitone steps (from -12 to 12). Pressing the [-] and [+] buttons simultaneously resets the value to 0.

**NOTE**

- If you want to transpose the pitch of the Audio Song, use the Pitch Shift parameter on page 73.
- The Transpose functions do not affect the Drum Kit or SFX Kit Voices.

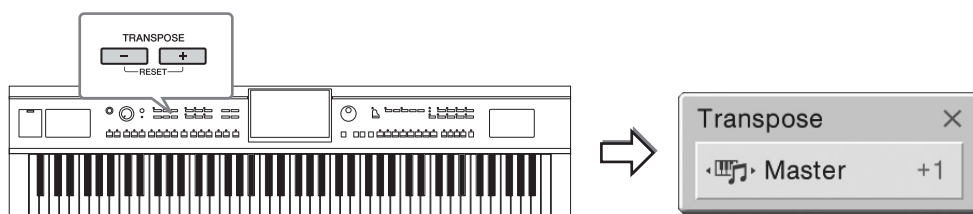

You can independently select the part to be transposed as desired. Touch the Transpose pop-up several times until the desired part appears, then use the TRANSPOSE [-]/[+] buttons to transpose it.

**NOTE**

Transpose can be done on the display also via [Menu] → [Transpose].

<p><b>Master</b></p>	<p>Transposes the pitch of the entire sound with the exception of the Audio Song and input sound from a microphone or the [AUX IN] jack.</p>
<p><b>Keyboard</b></p>	<p>Transposes the keyboard pitch including the chord root for triggering Style playback.</p>
<p><b>Song</b></p>	<p>Transposes the pitch of the MIDI Song.</p>

### Fine tuning the pitch

By default, the pitch of the entire instrument is set to 440.0 Hz according to equal temperament. This setup can be changed from the display called up via [Menu] → [Tuning]. For details, refer to the Reference Manual on the website (page 9).

#### Hz (Hertz):

This unit of measurement refers to the frequency of a sound and represents the number of times a sound wave vibrates in a second. This instrument is tuned to 440.Hz by default to conform to the conventional tuning value (440.0Hz) of acoustic pianos.

## Adjusting the Volume Balance

From the Balance display called up via [Menu] → [Balance], you can adjust the volume balance among the keyboard parts (Main, Layer, Left), the Style, the Song, the microphone sound, and the sound input via [AUX IN] jack. Slide your finger vertically for each part to adjust the volume. You can also adjust the volume balance of sound input via the USB wireless LAN adaptor, if one is connected.

Since the volume of MIDI Songs and Audio Songs are handled individually, you need to set the volume balance for each case (when a MIDI Song is selected, or when an Audio Song is selected).

#### NOTE

A USB wireless LAN adaptor may not be included depending on your area.

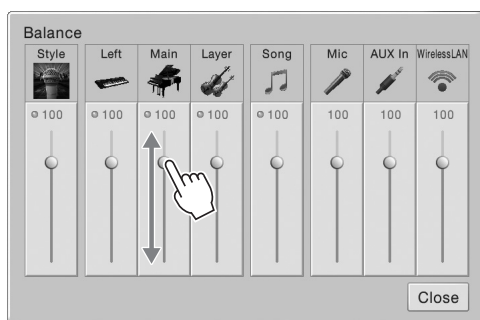

## Restoring the Factory-programmed Settings

While holding the C7 key (right-most key on the keyboard), turn the power on. This restores all of the settings to their factory defaults.

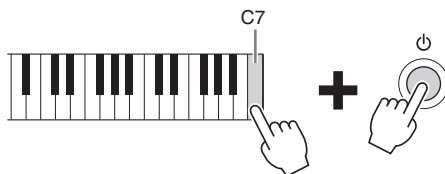

#### NOTE

You can also restore the factory default value of specified settings or delete all files/folders in the User memory on the display called up via [Menu] → [Utility] → [Factory Reset/Backup] → page 1/2. For details, refer to the Reference Manual on the website (page 9).

If you want to restore the default value of any parameter you've changed, touch and hold the value on the display (page 30).

## Data Backup

You can back up all data in the User memory of this instrument (except for Protected Songs) and all settings to the USB flash drive as a single file. This procedure is recommended for data security and backup in case of damage.

### NOTE

- Before using a USB flash drive, be sure to read “Connecting USB Devices” on page 97.
- You can back up User data such as Voice, Song, Style, and Registration Memory by copying them individually to USB flash drive. For instructions, refer to page 35.
- You can back up the System settings, MIDI settings, User Effect settings, and Music Finder Records individually.

- 1 Connect the USB flash drive to the [USB TO DEVICE] terminal as backup destination.
- 2 Call up the display via [Menu] → [Utility] → [Factory Reset/ Backup] → page 2/2.

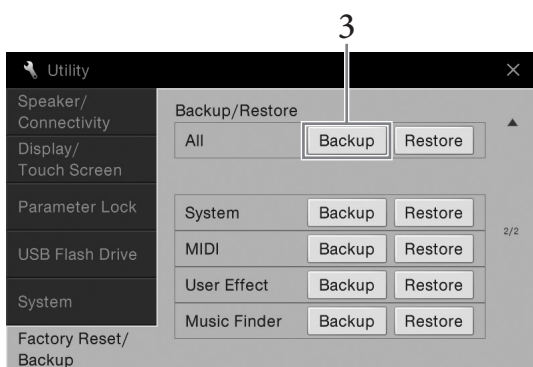

- 3 Touch [Backup] of “All” to save the backup file to the USB flash drive.

## Restoring the Backup File

To do this, touch [Restore] of “All” in step 3 above. When the operation is complete, the instrument will be restarted automatically.

### NOTICE

- Files including Protected Songs in the User memory of the instrument are replaced by restoring the backup file. Move or copy the files in the User memory of the instrument to USB flash drive before restoring (page 35).
- Completing the backup/restore operation may take a few minutes. Do not turn off the power during backup or restoring. If you turn off the power during backup or restoring, data may be lost or damaged.

# Piano Room

## – Enjoying the Piano Performance –



The Piano Room function is for those who want to simply, conveniently, and fully enjoy playing the instrument as a piano. No matter what settings you've made from the panel, you can instantly call up the optimum settings for piano performance with a single button press. You can also change the piano settings as you like, or you can enjoy playing the piano as if you are in a small ensemble.

### Playing a Piano Performance in the Piano Room

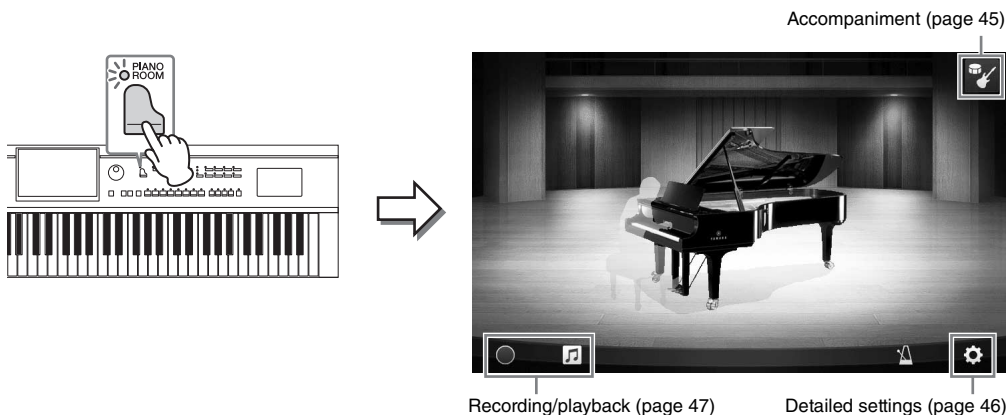
- 1 Press the  [PIANO ROOM] button to call up the Piano Room display.**  
This calls up the relevant panel settings for piano performance. All other functions except for the display (touch screen), [PIANO ROOM] button, [HOME] button, data dial, and master volume setting are disabled.



- 2 Play the keyboard.**  
Change the piano settings, such as Piano Type, Environment (Reverb Type), etc., according to the type of music you want to play.

<b>Piano Type</b>	Touch the picture of the piano to call up the piano list, and then select the desired one. When a grand piano Voice is selected, you can open or close the lid by sliding up or down on the lid or by rotating the data dial.
<b>Environment (Reverb Type)</b>	Touch the background picture of the piano to call up the environment list, and then select the desired one. This sets the Reverb Type for the selected Environment.
<b>Metronome</b>	Touch  (Metronome) to call up the pop-up screen. You can turn the metronome on or off, or change its tempo. You can also change the tempo by tapping  (Tap) in the pop-up display twice at the desired tempo.



To close a list or a setting display, touch anywhere outside of the list or setting display.

- 3 Press the  [PIANO ROOM] button or [HOME] button to exit the Piano Room display.**

# Playing the Piano in Session with Other Instruments

1 Press the  [PIANO ROOM] button to call up the Piano Room display.

2 Touch  at the upper right of the display.

Session players appear in the display. Session players can be shown or hidden by touching  or .

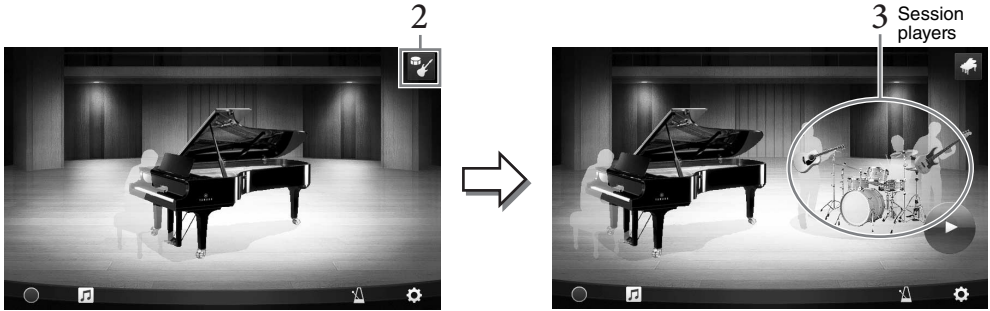

3 Select the type of accompaniment.

Touch the picture of the session players to call up the list for selecting the desired accompaniment. To close the list, touch anywhere outside of the list.

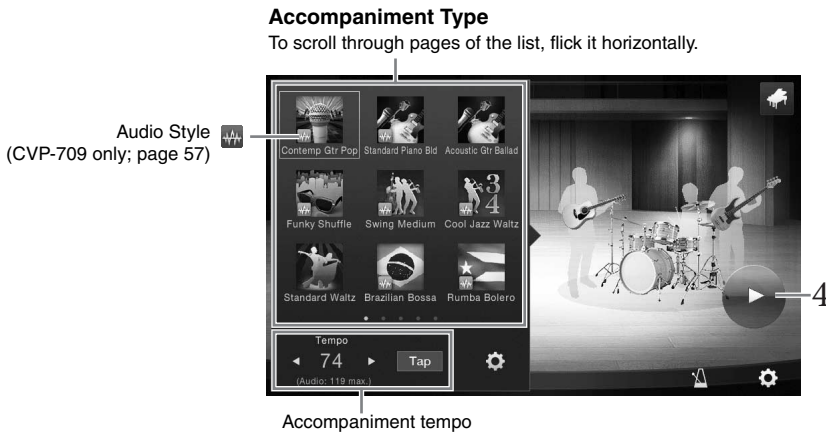

**NOTE**

(CVP-709 only) If you select an Audio Style (an accompaniment with a wave mark on its icon; see illustration above), the upper limit of the tempo is shown on the display. If the tempo exceeds the upper limit, a part of the accompaniment is muted.

4 Touch  (Start).

The Intro starts playing back.

5 Play the keyboard following a few measures of the Intro.

The Session players provide accompaniment for your performance. Jazz or Pop is recommended.

6 Touch  (Stop) to stop the accompaniment.

Accompaniment stops after an ending part is played.

**NOTE**

The function of accompaniment is available outside the Piano Room. For details, refer to page 55.

## Changing the Accompaniment Settings

Touch  (Setting), from the display of step 3 on page 45, to call up the display for adjusting the volume of the accompaniment or for turning each part of the accompaniment on or off. For details, refer to the Reference Manual on the website (page 9).

## Changing/Resetting the Piano Room Settings

You can change various Piano Room settings as you like. You can also restore all Piano Room settings to the default.

- 1 Press the  [Piano Room] button to call up the Piano Room display.

To change the settings of the accompaniment, touch  to call up the session players.



- 2 Touch  (Settings) to change the settings.

 : Shaded items are available only when session players are displayed.

<b>Environment*</b>	For selecting the environment (Reverb Type).
<b>Lid Position*</b>	Determines how much the Lid is opened. Available only when a grand piano Voice is selected.
<b>Tune</b>	Determines the pitch of this instrument in 1 Hz steps.
<b>Dynamics Control</b>	Determines how the volume of the accompaniment responds to the strength with which you play the keys. Off .....The accompaniment volume does not respond to your playing strength. Narrow .....The accompaniment volume changes over a narrow range in response to your playing strength. In other words, you must play very strongly or softly to have the volume change. Medium .....The accompaniment volume changes normally in response to your playing strength. Wide .....The accompaniment volume changes over a wide range in response to your playing strength. In other words, playing strongly or softly produces greater changes in the volume.
<b>Section Control*</b>	Turning this on calls up buttons for changing variations (Sections) of accompaniment (A, B, C, D) in the display. By using these sections effectively, you can easily make your performance sound more dynamic and professional.
<b>Fingering Type*</b>	Set the Fingering type (page 64) to “AI Full Keyboard” or “AI Fingered.”
<b>Split Point*</b>	Set the Split Point (Style) (page 50) when the “AI Fingered” is selected for Fingering Type.
<b>Reset</b>	Restores all settings of Piano Room to the default.

The settings marked with \* (asterisk) will be maintained even if you exit from this display or turn off the power. Pressing the [PIANO ROOM] button next time will call up the Piano settings which were made the previous time.

## Recording your Performance in the Piano Room

You can record your performance in Piano Room to the instrument or a USB flash drive.

### NOTE

- When you record to the instrument, the method of recording is MIDI. When you record to a USB flash drive, the method of recording is Audio. Refer to page 75 for details on the difference between MIDI and Audio recordings.
- In Audio recording, the data is saved in WAV format by default. However, you can also set it to MP3 format on the display called up via [Menu] → [SongSetting] → [Rec] → [Audio Rec Format].
- (CVP-709 only) When you record your performance using an Audio Style to a USB flash drive, record it by using Audio recording in WAV format (default). You cannot record it by using Audio recording in MP3 format.

**1** If you want to record to a USB flash drive, be sure to read “Connecting USB Devices” on page 97, then connect the USB flash drive to the [USB TO DEVICE] terminal before recording.

**2** Press the [Piano Room] button to call up the Piano Room display.

Make any necessary settings, such as the type of piano, calling up the session players, and so on.

**3** Touch  to call up the file list, and select the location for saving the file.

 USER (USER): The instrument itself

 USB (USB): Connected USB flash drive

**4** To close the display called up in step 3, touch anywhere outside the display.





**5** Touch  (Start recording) to start recording, and then play the keyboard.

**6** Touch  (Stop recording) to stop the recording.

**7** After a message appears prompting you to save, touch “Yes” to save the file.

### NOTICE

The recorded data will be lost if you turn the power off without executing the save operation.

**8** To hear the recorded performance, touch , then touch  (Playback) on the display that is called up.

Touch  (Stop) to stop the playback.

### NOTE



- Data that was recorded in the Piano Room can be played outside of the Piano Room. Refer to page 66 for details.
- (CVP-709 only) Songs you’ve recorded with Audio Styles to the instrument must be converted to Audio Songs, if you want to play them outside of the Piano Room. (Follow the on-screen messages.)

## Playing Back Recorded Files, Changing File Names, Deleting Files

**1** Select the location where the desired file is saved according to the step 1 – 3 above.

**2** Touch the desired file.

**3** Touch the desired icon.

Touch  (Playback) to start playback. Touch  (Stop) to stop playback.

Touch  to change the name of file. For details about entering characters, refer to page 37.

Touch  to delete the file.

# Voices

## – Playing the Keyboard –

The instrument features a wide variety of exceptionally realistic instrumental Voices, including piano, guitar, strings, brass, wind instruments and more.

### Playing Preset Voices

The Voices can be played via three keyboard parts: Main, Layer and Left. These playing modes allow you to play just one single Voice (Main), play two different Voices in layer (Main and Layer), or play different Voices in the right- and left-hand areas of the keyboard (Main/Layer and Left). By combining these three parts, you can create luscious instrument textures and convenient performance combinations.

#### NOTE

You can also play only the Layer part by turning the Main part off.

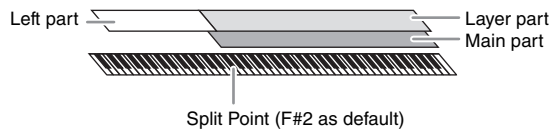

When the Left part is turned off, the entire keyboard is used for the Main and Layer parts. When the Left part is turned on, the F#2 and lower keys are used for the Left part while the upper keys (excluding F#2) are used for the Main and Layer parts. The key which divides the keyboard into the left-hand and right-hand areas is referred to as “Split Point” and its guide lamp lights when the Left part is turned on. The Voices of the parts which are turned on can be confirmed on the Home display.

#### NOTE

The Split Point can be changed (page 50).

### 1 Select the keyboard part then call up the Voice Selection display.

Do this to select a Voice for each keyboard part.

#### ■ Touching the display

#### 1-1 On the Home display, touch [Main], [Left], or [Layer] to turn on the desired keyboard part.

The center of the display shows the keyboard parts which are turned on and their corresponding Voices.



#### 1-2 Touch the Voice of the desired part to call up the Voice Selection display.



## ■ Using the panel buttons

**1-1 To select the keyboard part, press the VOICE [MAIN/LAYER/LEFT] button repeatedly if necessary until the desired part's lamp lights.**

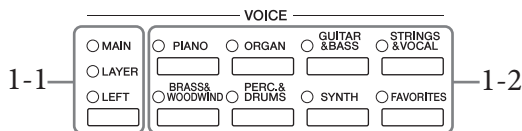

**1-2 Press one of the desired VOICE category buttons to call up the Voice Selection display.**

### NOTE

- You can select Voices for the Main and Layer parts simply by using the Voice category selection buttons. While holding down one of the Voice category selection buttons, press another Voice category selection button. The Voice corresponding to the first pressed button is assigned to the Main part while the Voice of the second pressed button is assigned to the Layer part.
- You can change the sub category by pressing the same Voice category button twice or more.

**2 Touch the desired Voice.**

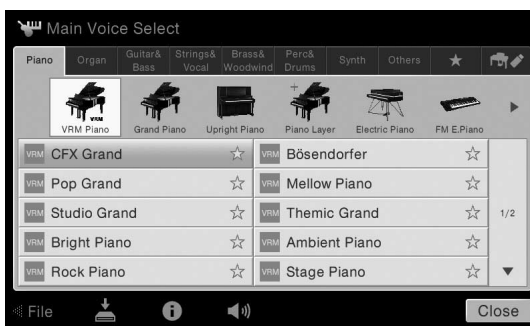

### NOTE

The "Others" tab contains XG Voices and so on. For details about how to select those Voices, refer to the Reference Manual on the website (page 9).

#### To hear the characteristics of the Voices:

Touch (Demo) to start demo playback of the selected Voice. Touch (Demo) again to stop playback.

Touch (Information) to call up the Voice Information window, which may or may not be available depending on the Voice.

### NOTE

You can play the Demo also by touching the Demo icon which appears in the Information window.

**3 Make sure that the desired keyboard part is turned on.**

The on/off setting for the keyboard part can be made as described in step 1-1 in "Touching the display" above.

**4 Play the keyboard.**



### NOTE

The Voice settings can be memorized to Registration Memory (page 88).

## Voice Characteristics

At the left side of each Voice name on the Voice Selection display, the icon which represents its defining characteristic is indicated.

There are various Voice characteristics; however, only the following ones are covered here. For detailed explanations, refer to the Reference Manual on the website (page 9).

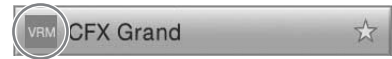

- **VRM: VRM Voices (page 52)**

These recreate the characteristic string resonance of a real acoustic piano.

- **S.Art / S.Art2: Super Articulation (S.Art, S.Art2) Voices (page 53)**

The word “articulation” in music usually refers to the transition or continuity between notes. This is often reflected in specific performance techniques, such as staccato, legato and slur.

- **Organ Flute: Organ Flutes Voices (page 54)**

Lets you recreate all of the classic organ sounds by adjusting the flute footage levels and the percussive sounds, just like on conventional organs.

- **Drum / SFX: Drum Voices, SFX: SFX Voices**

Lets you play various drums and percussion instruments or SFX (sound effects) sounds on the keyboard. Details are given in the Drum/Key Assignment List of the separate Data List. When the icon (Drum Kit Tutor) appears in the Voice area of the Home display or below the Voice Selection display, you can display the Key assignment by touching the icon. For details, refer to the Reference Manual on the website (page 9).

## Setting the Split Point

The key which divides the keyboard into two or three areas is referred to as “Split Point.” There are two types of Split Point: “Left Split Point” and “Style Split Point.” The “Left Split Point” divides the keyboard into the Left Voice area and Main Voice area while the “Style Split Point” divides the keyboard into the Chord area and the Main or Left Voice area. Though both Split Points are at the same key (F#2) by default, you can also set them individually (as shown).

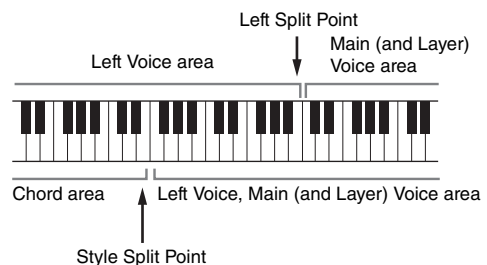

### 1 Call up the Split Point/Fingering window: [Menu] → [Split&Fingering].

#### NOTE

The Split Point/Fingering window can be called up also by holding the keyboard illustration on the Home display.

### 2 Touch [Left] or [Style] to turn it on.

If you want to set both Split Points to the same key, turn both of them on.

### 3 Touch [◀]/[▶] to select the desired key as Split Point.

You can set the Split Point also by pressing the actual key while holding down the keyboard illustration on the display.

#### NOTE

The Left Split Point cannot be set lower than the Style Split Point.

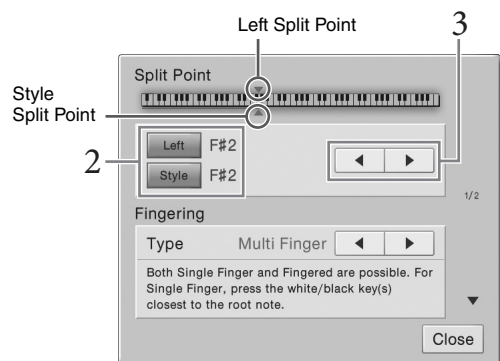

## Maintaining the Left Voice (even when releasing the keys)

When the Left Hold function is set to “On,” the Left Voice is held even when the keys are released ([Menu] → [Keyboard] → [Setting]). Non-decaying Voices such as strings are held continuously, while decay-type Voices such as piano decay more slowly (as if the sustain pedal has been pressed).

When the Left Hold is “On,” an “H” indication appears at the left side of the keyboard illustration in the center of the Home display.



## Calling up the default Piano Settings (Piano Reset)

When you turn the power on, the Voice is set to “CFX Grand” allowing you to play the instrument as a piano across the entire keyboard. No matter what settings you’ve made from the panel, you can instantly call up these default settings.

### NOTE

This function cannot be used while the Piano Room display (page 44) or the Piano Lock display (page below) is shown.

- 1 Press and hold down the [PIANO ROOM] button for two seconds or longer.**  
A message appears in the display.
- 2 Touch [Reset] to call up the default piano settings.**

## Piano Lock Function

You can “lock” the panel settings to the default Piano settings instantly, no matter what settings you’ve made from the panel. Once locked, the instrument stays in the default settings of Piano, even if other buttons are pressed — only allowing you to play the keyboard, use the pedals, or adjust the master volume. In other words, Piano Lock prevents you from accidentally selecting and playing another sound during your piano performance.

- 1 Press and hold down the [PIANO ROOM] button for two seconds or longer.**  
A message appears in the display.
- 2 Touch [Lock] to call up the Piano Lock display.**  
The panel settings will be locked in the default settings of Piano.

To disable Piano Lock, press and hold the [PIANO ROOM] button again for two seconds or longer. If you turn off the power with Piano Lock enabled, turning on the power next time will call up the Piano Lock display.

## Playing Realistic Resonance-enhanced Piano Sounds (VRM Voices)

On an actual acoustic piano, if you press the damper pedal and play a key, not only does the string of the pressed key vibrate, it also causes other strings and the soundboard to vibrate, with each influencing the rest, creating a rich and brilliant resonance that sustains and spreads. The VRM (Virtual Resonance Modeling) technology featured in the instrument reproduces the complicated interaction of both string and soundboard resonance faithfully using a virtual musical instrument (physical modeling), and makes the sound more like a real acoustic piano. Since instantaneous resonance is made at the moment according to the state of the keyboard or pedal, you can vary the sound expressively by changing the timing of your pressing the keys, and the timing and depth of your pressing the pedal. The default setting of this function is on. An icon (VRM) is shown at the left side of the Voice name of a VRM Voice on the Voice Selection display. Simply by selecting a VRM Voice, you can enjoy the VRM effect.

You can turn the VRM function on or off, and adjust the depth. ([Menu] → [Voice Setting] → [Piano] → 1/2 page)

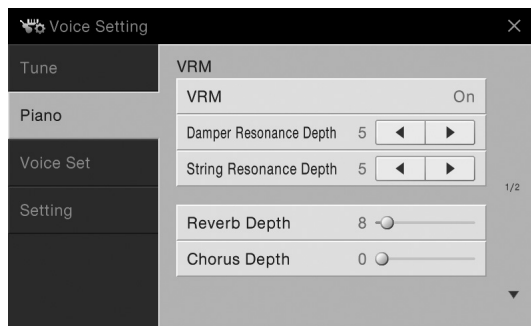



<b>VRM</b>	Turns the VRM function on or off.
<b>Damper Resonance Depth</b>	Adjusts the depth of the VRM effect heard when pressing the damper pedal.
<b>String Resonance Depth</b>	Adjusts the depth of the VRM effect heard when playing the keyboard.
<b>Reverb Depth</b>	Adjusts the Reverb depth for VRM Voices.
<b>Chorus Depth</b>	Adjusts the Chorus depth for VRM Voices.

### NOTE

These settings are applied commonly to all parts for which VRM Voices are selected.

## Playing Super Articulation Voices

The Super Articulation Voices (S.Art Voices and S.Art2 Voices) enable you to create subtle, very realistic musical expressions, simply by how you play. The icons  /  are shown on the left side of the voice name of Super Articulation Voices (S.Art, S.Art2) on the Voice Selection display.

### ■ S.Art Voices

The S.Art Voices provide many benefits with great playability and expressive control in real time.

#### Example: Saxophone Voice

If you play a C note and then an adjacent D in a very legato way, you will hear the note change seamlessly, as though a saxophone player played it in a single breath.

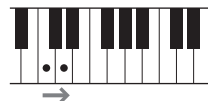

#### Example: Guitar Voice

If you play a C note and then the E just above in a very legato but firm way, the pitch slides up from C to E.

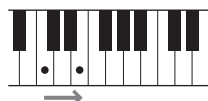

### ■ S.Art2 Voices (CVP-709 only)

For wind instrument Voices and Violin Voices, a special technology called AEM has been used, which features detailed samples of special expressive techniques used on those specific instruments — to bend or slide into notes, to “join” different notes together, or to add expressive nuances at the end of a note, etc.

#### NOTE

AEM is a technology that simulates the sound of acoustic instruments naturally by smoothly joining the most appropriate sound samples selected from the data base in realtime during performance.

#### Example: Clarinet Voice

If you hold a C note and play the B<sup>b</sup> above, you’ll hear a glissando up to the B<sup>b</sup>. Some “note off” effects are also produced automatically when you hold a note for over a certain time.





### Adding Articulation Effects by Using the Pedal

When you assign an S.Art or S.Art2 Voice to the Main part, the function of the center or/and left pedals are switched to control articulation effects. Pressing a pedal triggers different playing effects, separate from your keyboard playing. For example, pressing a pedal for a saxophone Voice can produce breath noises or key noises, while doing the same for a guitar Voice can produce fret noises or body-tapping sounds. You can effectively intersperse these into the notes as you play.

When an S.Art2 Voice is selected, pressing a pedal and playing/releasing a note enables you to add articulation effects, such as bend up/down, glissando up/down, brass falls, etc.

#### NOTE

- If you want to lock the pedal function regardless of the Voice, turn off the Switch With Main Voice parameter called up via [Menu] → [Assignable] → [Pedal] → [Switch With Main Voice].
- If you assign the Articulation function to the ASSIGNABLE buttons (page 32), you can control articulation effects by using the buttons instead of the pedals.

For specific performance instructions on certain Voices, you can call up the Information window of the selected S.Art Voice or S.Art2 Voice by touching the  /  icon which appears on the upper right of the Voice name on the Home display.

#### NOTE

- S.Art and S.Art2 Voices are only compatible with other models which have those types of Voices installed. Any Song or Style data you’ve created on the instrument using these Voices will not sound properly when played back on other instruments.
- S.Art and S.Art2 Voices sound differently depending on the keyboard range, velocity, touch, etc. Hence, if you turn on a Keyboard Harmony effect, change the transpose setting or change the Voice Settings, unexpected or undesired sounds may result.
- The characteristics of S.Art2 Voices (default vibrato setting and articulation effects applied by the pedals) are effective for real-time performance; however, these effects may not be completely reproduced when you play back a Song which has been recorded using S.Art2 Voices.

## Creating Original Organ Flutes Voices

The instrument uses advanced digital technology to recreate the legendary sound of vintage organs. Just as on a traditional organ, you can create your own sound by increasing and decreasing the levels of the flute footages. The created Voice can be saved for future recall.

### NOTE

The term “footage” is a reference to the sound generation of traditional pipe organs, in which the sound is produced by pipes of different lengths (in feet).

- 1 **On the Voice Selection display, select the desired Organ Flutes Voice.**  
Touch the [Organ Flutes] tab in the [Organ] category, then select the desired Organ Voice.
- 2 **Return to the Home display, then touch  (Organ Flutes) located at the upper right of the Voice name to call up the Organ Flutes Voice Edit display.**
- 3 **Slide the Footage levers to adjust the footage settings.**  
The footage settings determine the basic sound of the Organ Flutes.

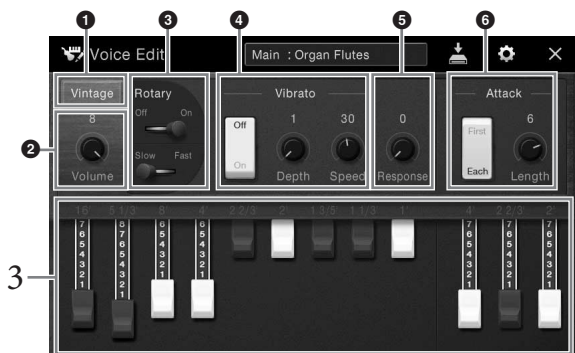

If you want, you can select the Organ type, change the settings such as Rotary Speaker and Vibrato.

### NOTE

You can also make Effects and EQ settings. For details, refer to the Reference Manual on the website (page 9).

1	<b>Organ Type</b>	Specifies the type of organ tone generation to be simulated.
2	<b>Volume</b>	Determines the volume of the entire Organ Flutes sound.
3	<b>Rotary Speaker</b>	Alternately switches between the slow and fast rotary speaker speeds. This parameter is available only when an effect which contains “Rotary” or “Rot” in its name is applied.
4	<b>Vibrato</b>	Turns the vibrato on or off, and allows you to adjust the vibrato depth and vibrato speed.
5	<b>Response</b>	Adjusts the response speed of both the Attack and Release portions of the sound.
6	<b>Attack</b>	Switches between two different Attack modes: First and Each, and determines the length of the Attack sound.

- 4 **Touch  (Save) and save the created Organ Voice.**

For instructions on saving, refer to page 33.

### NOTICE

The settings will be lost if you select another Voice or turn the power to the instrument off without executing the Save operation.

### NOTE

In addition to the Organ Flutes Voices, other Voices can be edited by calling up the Voice Edit display after selecting the desired Voice. For details, refer to the Reference Manual on the website (page 9).

# Styles

## – Playing Rhythm and Accompaniment –

The instrument features a variety of accompaniment and rhythmic backing patterns (called “Styles”) in a variety of different musical genres including pop, jazz, and many others. Each Style features Auto Accompaniment, letting you produce automatic accompaniment playback simply by playing “chords” with your left hand. This lets you automatically recreate the sound of a full band or orchestra — even if you’re playing by yourself.

### Playing with a Style

Try out Style accompaniment with the following song. After you understand how to use the Style, try out other songs by using various Styles.

#### Mary Had a Little Lamb (Style: Country 8Beat)

#### NOTE

The Fingering type (page 64) of “Multi Finger” (default setting) or “Single Finger” can be used for the example score here; the instructions hereafter assume one or the other is used.

- 1 On the Home display, touch the Style name to call up the Style Selection display.

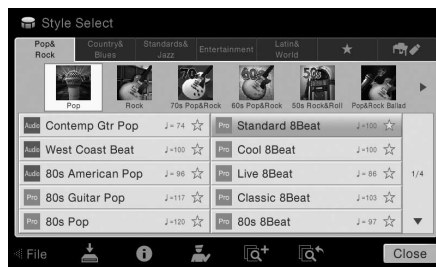

## 2 Touch the desired Style.

For the example score above, touch [Country & Blues] category and touch [Modern Country], then touch [Country 8Beat].”

The Style category can be selected also by pressing one of the STYLE buttons.

### NOTE

You can change the sub category by pressing the same Style category button twice or more.

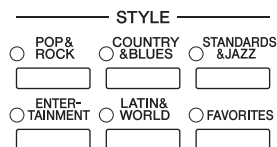

## 3 Make sure that the STYLE CONTROL [ACMP ON/OFF] button is turned on.

When turned on, the specific left-hand section of the keyboard can be used as the Chord section, and chords played in this section are automatically detected and used as a basis for fully automatic accompaniment with the selected Style.

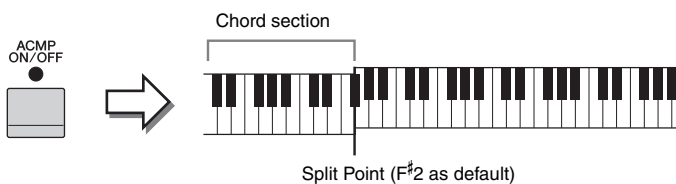

### NOTE

The Split Point can be changed as desired (page 50).

## 4 Return to the Home display, touch [◀] at the upper left to expand the Style area, then touch [≡] (SYNC START) to enable Sync Start.



Here and in the later steps, the operation in the Style area of the Home display can be controlled by the STYLE CONTROL buttons (page 57).

## 5 Play a chord with your left hand to start the selected Style.

Referring to the notation on page 55, play chords with your left hand and a melody with your right.

## 6 Touch [▶/■] (START/STOP) to stop Style playback.

You can also stop playback by pressing one of the ENDING [I] – [III] buttons at the “Ending” location on the notation (page 55).



## Style Characteristics

The Style type and its defining characteristics are indicated on the Preset Style icon, such as Audio (CVP-709 only) and Pro. There are various Style characteristics; however, only Audio Styles are covered here.



For details about the other icons, refer to the Reference Manual on the website (page 9).

### • **Audio:** Audio Style (CVP-709 only)

The Audio Styles have been specially produced by adding audio recordings of studio musicians playing in various recording studios worldwide. This adds all the natural feel, ambience and warmth to the drums and percussion of the Style, giving your performance greater expressive potential. Specifically, it retains the subtle nuances and grooves that are difficult to reproduce using the preset drum/percussion kit. Yamaha Time Stretch Technology allows the audio to follow your tempo changes without changing pitch, so everything stays in perfect sync.

### NOTE

- Audio Styles may take more time to load than others.
- If the tempo is set to over 160% of the default, the audio part is muted.
- Audio Styles cannot be copied to USB flash drive. (Audio Styles can be copied only to User memory of the instrument.)
- You can record your performance using an Audio Style when the method of Audio recording is in WAV format, it cannot be recorded when in MP3 format. Also, if you record the song using MIDI recording, the audio part cannot be recorded. Refer to page 75 for details. However, only in the Piano Room, the audio part can be recorded by using MIDI recording (page 47).

A Style generally consists of eight parts (channels): rhythm, bass, etc., although Audio Styles (CVP-709 only) consist of nine parts, including an additional Audio part. You can add variations and change the feeling of a Style by selectively turning channels on/off or by changing the Voices (page 93).

### Style File Compatibility

This instrument uses the SFF GE file format (page 8) and can play back existing SFF files; however, they will be saved in the SFF GE format when the file is saved (or loaded) in this instrument. Please keep in mind that the saved file can only be played back on instruments that are compatible with the SFF GE format.

## Style Control Operations

To do this, use the on-screen buttons called up by touching [◀] in the Style area of the Home display, or use the STYLE CONTROL buttons.

### NOTE

For instructions on adjusting the tempo, refer to page 40.

### Home display

While Style is stopped



Style Control

While Style is playing



Style Control

### STYLE CONTROL buttons

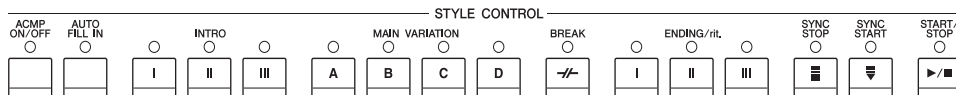

[ACMP ON/OFF], [AUTO FILL IN] and [SYNC STOP] can be controlled only by using the panel buttons.

## To Start/Stop Playing

### ■ [▶/■] (START/STOP)

Starts playback of the rhythm part of the current Style. To stop playback, press this button again.

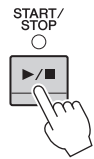

#### NOTE

Starts playback of the rhythm part and audio part if the current Style is an Audio Style (CVP-709 only).

### Playing back both rhythm and auto accompaniment

If you turn on the [ACMP ON/OFF] button, both the rhythm part and auto accompaniment can be played back when playing chords in the chord section during Style playback.

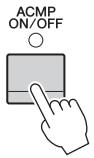

#### NOTE

The rhythm does not sound for some Styles. When you want to use any of these Styles, always make sure that [ACMP ON/OFF] button is turned on.

### ■ [≡] (SYNC START)

This puts the Style playback in standby. The Style starts playing back when you play a chord with your left hand (when [ACMP ON/OFF] is on) or you press any note on the keyboard (when [ACMP ON/OFF] is off). During Style playback, pressing this button stops the Style and puts playback in standby.

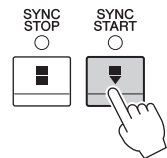

### ■ [SYNC STOP] button

You can start and stop the Style anytime you want by simply playing or releasing the keys in the chord section of the keyboard. Make sure that the [ACMP ON/OFF] button is on, press the [SYNC STOP] button, then play the keyboard.

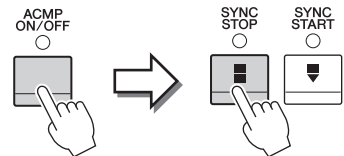

#### NOTE

When the Fingering type (page 64) is set to "Full Keyboard" or "AI Full Keyboard," Sync Stop cannot be turned on.

### ■ INTRO [I] – [III]

The instrument features three different Intro sections to add an introduction before starting Style playback. After pressing (or touching) one of the INTRO [I] – [III] buttons, start playback of the Style. When the Intro finishes playing, Style playback automatically shifts to the Main section.

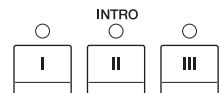

#### NOTE

When you select INTRO [II] or [III], you need to play chords in the chord section to play the complete Intro section.

### ■ ENDING [I] – [III]

The instrument features three different Ending sections to add an ending before stopping Style playback. When you press (or touch) one of the ENDING [I] – [III] buttons while a Style is playing back, the Style will automatically stop after the ending is played. You can have the ending gradually slow down (ritardando) by pressing the same ENDING button once again, while the ending is playing.

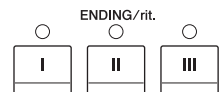

#### NOTE

If you press the ENDING [I] button when the Style is playing, a fill-in automatically plays before ENDING [I].

## Changing Variation (Sections) During Style Playback

Each Style features four different Main sections, four Fill-in sections and a Break section. By using these sections effectively, you can easily make your performance sound more dynamic and professional. The section can be freely changed while the Style is playing back.

### ■ MAIN VARIATION [A] – [D]

Press (or touch) one of the MAIN VARIATION [A] – [D] to select the desired Main section (the button lights in red). Each is an accompaniment pattern of a few measures and it plays indefinitely. Pressing the selected MAIN VARIATION button again maintains the same section, but plays an appropriate fill-in pattern to spice up the rhythm and break the repetition.

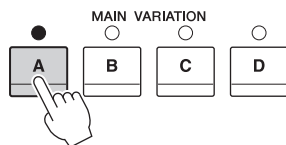

Press the selected Main section (lit in red) again.

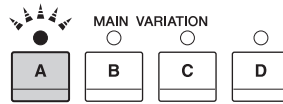

The fill-in of the selected Main section plays (flashes in red).

### AUTO FILL function

When the [AUTO FILL IN] button is turned on, pressing any of the Main [A] – [D] buttons as you play automatically plays a fill-in section.

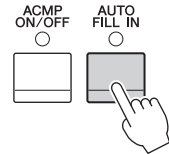

### ■ [—/—] (BREAK)

This lets you add dynamic breaks in the rhythm of the accompaniment. Press this button during Style playback. When the one-measure Break pattern finishes playing, the Style playback automatically shifts to the Main section.



### About the lamp status of the section buttons (INTRO/MAIN VARIATION/BREAK/ENDING)

- **Red:** The section is currently selected.
- **Red (flashing):** The section will be played next, following the currently selected section.
  - \* The Main [A] – [D] button lamps also flash in red.
- **Green:** The section contains data but is not currently selected.
- **Off:** The section contains no data and cannot be played.

## Calling up Panel Settings Appropriate for the Current Style (One Touch Setting)

One Touch Setting is a powerful and convenient feature that automatically calls up the most appropriate panel settings (Voices or effects, etc.) for the currently selected Style, with the touch of a single button. If you've already decided which Style you wish to use, you can have One Touch Setting automatically select the appropriate Voice for you.

- 1 Select the desired Style (steps 1– 2 on page 55).
- 2 Press one of the ONE TOUCH SETTING [1] – [4] buttons.

Not only does this instantly call up all the settings (Voices, effects, etc.) that match the current Style, it also automatically turns on ACMP and SYNC START, so that you can immediately start playing the Style.

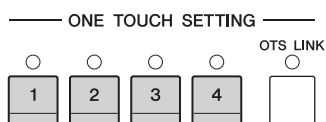

### Confirming the One Touch Setting Contents

In the Style Selection display, touch **i** (Information) to call up the Information window that shows what Voices are assigned to the ONE TOUCH SETTING [1] – [4] buttons for the current Style. You can call up the desired settings also by touching one of the One Touch Settings 1– 4 directly on the Information window.

#### NOTE

Gray color for a Voice name indicates that the corresponding Voice part is currently turned off.

- 3 As soon as you play a chord with your left hand, the selected Style starts.

Each Style has four One Touch Setting setups. Press the other ONE TOUCH SETTING [1] – [4] buttons to try out other setups.

### Automatically Changing One Touch Settings with the Main Sections

The convenient OTS (One Touch Setting) Link function lets you automatically have One Touch Settings change when you select a different Main section (A – D). The Main sections A, B, C and D correspond to One Touch Settings 1, 2, 3 and 4 respectively. To use the OTS Link function, turn the [OTS LINK] button on.

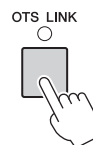

#### NOTE

You can change the timing in which the One Touch Settings change with MAIN VARIATION [A] – [D] changes. To do this, touch [Menu] → [StyleSetting] → [Setting] then set the OTS Link Timing parameter. For details, refer to the Reference Manual on the website (page 9).

## Memorizing original settings to One Touch Setting

You can memorize your original panel settings to the One Touch Setting. The newly created One Touch Setting will be saved in the User tab as a User Style, and you can call up the One Touch Setting as a part of the Style file.

- 1 Select the desired Style to memorize your One Touch Setting.
- 2 Make the desired panel settings, such as those for Voices and Effects.

### 3 Press the [MEMORY] button of REGISTRATION MEMORY.

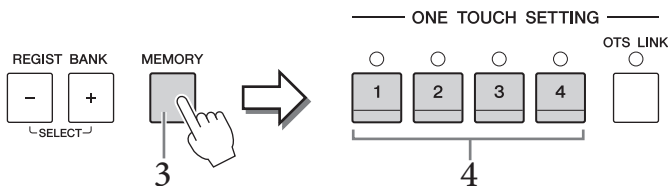

### 4 Press one of the ONE TOUCH SETTING [1] – [4] buttons.

A message appears prompting you to save the panel settings.

### 5 Touch [Yes] to call up the Style Selection display for saving your data, then save the current settings as a User Style.

For instructions on saving, refer to page 33.

#### NOTE

To cancel this operation, touch [No].

#### NOTICE

The memorized One Touch Setting will be lost if you change to another Style or you turn the power off without executing the save operation.

## Searching for Suitable Songs for the Current Style

You can search for music pieces and songs that are most suitable for playing with the current Style by using the Music Finder Records (page 85). You can automatically call up appropriate settings such as Voice, effect and pedal by selecting the desired music piece.

#### NOTE

Before following these instructions, we recommend that you import Music Finder Records (page 87).

### 1 Select the desired Style (steps 1– 2 on page 55).

### 2 In the Style Selection display, touch (Search).

The music pieces which can be played with the current Style are listed on the display.

#### NOTE

To exit from this status, touch [Cancel].

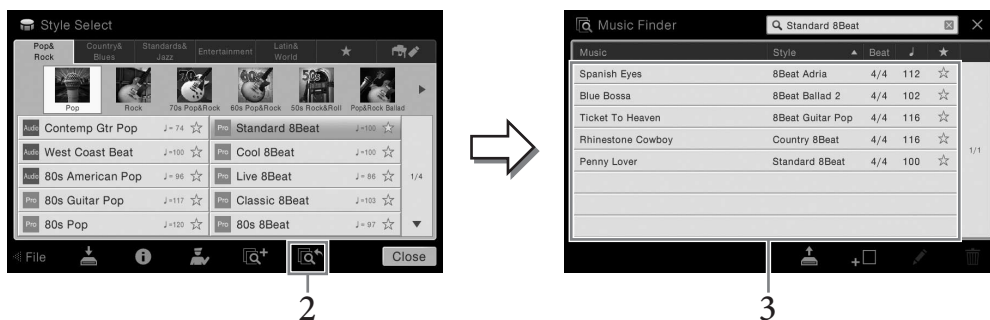

### 3 Select the desired music piece.

The appropriate panel settings for playing the music piece are called up.

#### NOTE

Depending on the particular selected Style, there may not be any Records available.

## Calling up Optimum Styles for Your Performance (Style Recommender)

This convenient function “recommends” optimum Styles for the song you want to perform, based on your performance.

- 1 On the Style Selection display, touch  (Recommender) to call up the Style Recommender display.

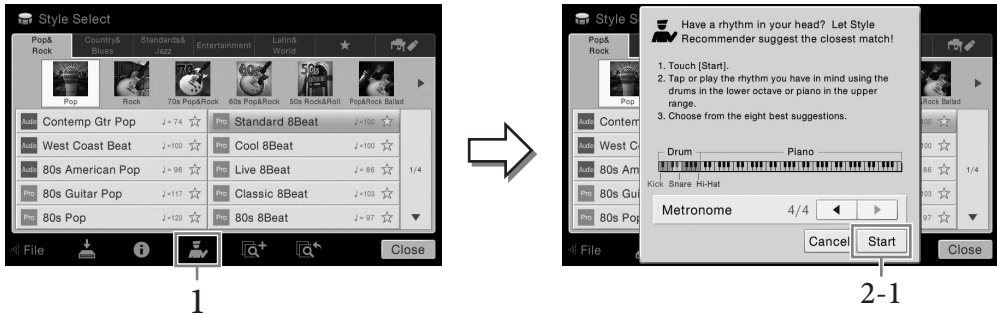

The keyboard is divided (at the B0 key) into two sections as below. The drum instruments (Kick, Snare and Hi-Hat) are assigned to the left-hand section while the piano sound is assigned to the right.

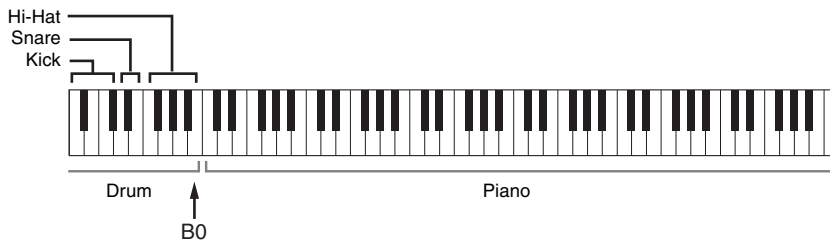

- 2 Use the Style Recommender function to find the Style.
  - 2-1 Touch [Start] to start the metronome, indicating that the Style Recommender function starts.
 

**NOTE**  
To cancel the operation, touch [Cancel].
  - 2-2 Use the TEMPO [-]/[+] buttons or [TAP TEMPO] button to adjust the tempo, and touch [◀]/[▶] on the display to select the beat.
  - 2-3 Play your performance on the Piano section for one or two measures along with the metronome. For better results, try playing with both hands. Or, play the rhythm you have in mind on the Drum section for one or two measures.
 

Your performance is analyzed for a few seconds, and then playback of the most recommended Style starts. In addition, the candidates of the other recommended Styles are listed in the display.

**NOTE**  
If the song you want to play starts from the middle of a measure, or has a short silence prior to the first note, you may get better results by pausing for a measure and start playing from the next measure.

Example 1:  
Play the following piece in the Piano section.



The Styles that best suit your performance and have a similar tempo are listed.

Example 2:  
Play the following rhythm in the Drum section of the keyboard.



The Styles that contain a similar drum pattern are listed.

### 3 Select the desired Style from the list.

Try playing keyboard along with the Style if it matches the song you want to play. If the Style called up doesn't match the song you want to play, touch [Retry], then return to step 2-2.

### 4 When you've found a Style you're satisfied with, touch [OK] to exit from the Style Recommender display.

### 5 Play the keyboard along with the Style you just found.

## Changing the Chord Fingering Type

By changing the Chord Fingering type, you can automatically produce appropriate accompaniment even if you don't press all of the notes which comprise a chord.



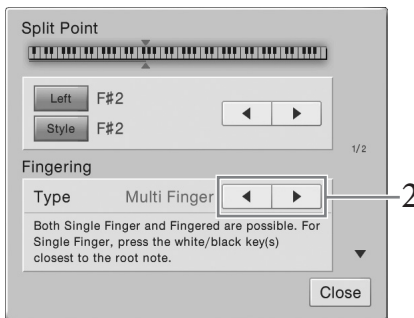

### 1 Call up the Split Point/Fingering window: [Menu] → [Split&Fingering].

#### NOTE

The Split Point/Fingering window can be called up also by holding the keyboard illustration on the Home display.



### 2 Touch [◀]/[▶] to select the desired Fingering Type.

<p><b>Single Finger</b></p> <p><b>C</b></p>  <p><b>Major chord</b> Press the root key only.</p> <p><b>Cm</b></p>  <p><b>Minor chord</b> Simultaneously press the root key and a black key to its left.</p> <p><b>C7</b></p>  <p><b>Seventh chord</b> Simultaneously press the root key and a white key to its left.</p> <p><b>Cm7</b></p>  <p><b>Minor seventh chord</b> Simultaneously press the root key and both a white and black key to its left.</p>	<p>Lets you easily play chords in the accompaniment range of the keyboard using only one, two or three fingers. This type is available only for Style playback.</p>
<p><b>Multi Finger</b></p>	<p>Automatically detects Single Finger or Fingered chord fingerings, so you can use either type of fingering without having to switch fingering types.</p>
<p><b>Fingered</b></p>	<p>Lets you finger your own chords on the chord section of the keyboard, while the instrument supplies appropriately orchestrated rhythm, bass, and chord accompaniment in the selected Style. The Fingered type recognizes the various chord types which are listed on the separate Data List booklet and can be looked up using the Chord Tutor function called up via [Menu] → [ChordTutor].</p>
<p><b>Fingered On Bass</b></p>	<p>Accepts the same fingerings as Fingered, but the lowest note played in the Chord section of the keyboard is used as the bass note, allowing you to play “on bass” chords. (In the Fingered mode, the root of the chord is always used as the bass note.)</p>
<p><b>Full Keyboard</b></p>	<p>Detects chords in the entire key range. Chords are detected in a way similar to Fingered, even if you split the notes between your left and right hands — for example, playing a bass note with your left hand and a chord with your right, or by playing a chord with your left hand and a melody note with your right.</p>



<b>AI Fingered</b>	Basically the same as Fingered, with the exception that less than three notes can be played to indicate the chords (based on the previously played chord, etc.).  <b>NOTE</b> Only in the Piano Room, your performance in the Chord section produces the sound of the selected Voice as well as that of the accompaniment.
<b>AI Full Keyboard</b>	When this advanced fingering type is engaged, the instrument will automatically create appropriate accompaniment while you play just about anything, anywhere on the keyboard using both hands. You don't have to worry about specifying the Style chords. Although the AI Full Keyboard type is designed to work with many songs, some arrangements may not be suitable for use with this feature. This type is similar to Full Keyboard, with the exception that less than three notes can be played to indicate the chords (based on the previously played chord, etc.). 9th, 11th and 13th chords cannot be played. This type is available only for Style playback.

**NOTE**

When the Fingering Type is set as "Fingered\*", it cannot be changed. Change the Chord Detection Area to "Lower" via [Menu] → [Split&Fingering] → Page 2/2, and then change the Fingering Type.

By changing the Chord Detection Area from the left-hand section to the right-hand section, you can play the bass line with your left hand while using your right hand to control Style playback. For details, refer to the Reference Manual on the website (page 9).

## Chords

For users who are unfamiliar with chords, this handy chart features common chords for your quick reference. Since there are many useful chords and many different ways to use them musically, refer to commercially available chord books for further details.

★ Indicates the root note.

Major	Minor	Seventh	Minor Seventh	Major Seventh
<b>C</b> 	<b>Cm</b> 	<b>C7</b> 	<b>Cm7</b> 	<b>CM7</b> 
<b>D</b> 	<b>Dm</b> 	<b>D7</b> 	<b>Dm7</b> 	<b>DM7</b> 
<b>E</b> 	<b>Em</b> 	<b>E7</b> 	<b>Em7</b> 	<b>EM7</b> 
<b>F</b> 	<b>Fm</b> 	<b>F7</b> 	<b>Fm7</b> 	<b>FM7</b> 
<b>G</b> 	<b>Gm</b> 	<b>G7</b> 	<b>Gm7</b> 	<b>GM7</b> 
<b>A</b> 	<b>Am</b> 	<b>A7</b> 	<b>Am7</b> 	<b>AM7</b> 
<b>B</b> 	<b>Bm</b> 	<b>B7</b> 	<b>Bm7</b> 	<b>BM7</b> 

# Song Playback

– Playing and Practice Songs –

For the Clavinova, “Song” refers to MIDI or audio data which include preset songs, commercially available music files, etc. Not only can you play back a Song and listen to it, but you can also play the keyboard along with Song playback.

There are two kinds of Songs that can be recorded and played back on this instrument: MIDI Songs and Audio Songs.



## • MIDI Song

A MIDI Song is comprised of your keyboard performance information and is not a recording of the actual sound itself. The performance information refers to which keys are played, at what timing, and at what strength — just as in a musical score. Based on the recorded performance information, the tone generator (of the Clavinova, etc.) outputs the corresponding sound. Since MIDI Song data contains the information such as keyboard part and Voice, you can practice effectively by viewing the score, turning the particular part on or off, or changing Voices.

## • Audio Song

An Audio Song is a recording of the performed sound itself. This data is recorded in the same way as that used in recording cassette tapes, or with voice recorders, etc. Audio Songs can be played back on portable music players and many other devices, making it easy for you to let others hear what you have played.

Availability of functions differs between MIDI Songs and Audio Songs. In this chapter, the following icons indicate whether or not the explanation applies to MIDI Songs or Audio Songs individually.

Example:   ... Indicates explanation applies only to MIDI Songs.

## Playback of Songs

You can play back the following types of Songs.

- Preset Songs (MIDI Songs)
- Your own recorded Songs (see page 75 for instructions on recording)
- Commercially available Songs: MIDI files in SMF (Standard MIDI File) format, Audio files in WAV or MP3 format.

WAV	44.1 kHz sample rate, 16 bit resolution, stereo
MP3	MPEG-1 Audio Layer-3: 44.1/48.0 kHz sample rate, 64 – 320 kbps and variable bit rate, mono/stereo

### NOTE

- For a general overview of MIDI and how you can effectively use it, refer to “MIDI Basics” on website (page 9).
- For information on compatible MIDI formats, refer to page 8.

If you want to play back a Song in a USB flash drive, connect the USB flash drive containing Song data to the [USB TO DEVICE] terminal beforehand.

### NOTE

Before using a USB flash drive, be sure to read “Connecting USB Devices” on page 97.

# 1 On the Home display, touch the Song name to call up the Song Selection display.

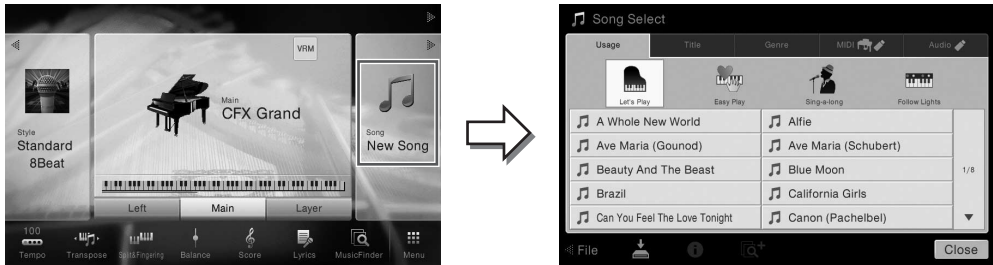

## NOTE

Song files (MIDI files) corresponding to the included Music Book are available for free downloading from the website (page 9).

# 2 Touch the desired Song on the display to select it.

A Preset Song can be selected from one of the following tabs:

- Usage: The Songs are divided into several usages.
- Title: The Songs are sorted in alphabetical order.
- Genre: The Songs are divided into several genres.

The Songs you recorded or the commercially available songs can be selected from one of the following tabs:

- **MIDI** : Calls up a list of the MIDI Songs in the instrument or in the USB flash drive.
- **Audio** : Calls up a list of the Audio Songs in the USB flash drive.

## NOTE

- Songs recorded to the instrument in Piano Room are listed in the "Piano Room" folder (in the "User" folder of the MIDI tab).
- Songs recorded to the USB flash drive in Piano Room are listed in the "Audio" tab.
- On the Song Selection display or the Home display, you can distinguish the data format of the Audio Song by the icon shown next to the Song name. If it is in MP3 format, "MP3" appears in the icon, and in case of WAV format, nothing is shown.
- (CVP-709 only) MIDI Songs you've recorded with Audio Styles in the Piano Room must be converted to Audio Songs. (Follow the on-screen messages.)

### Viewing Song information

When an Audio Song or a protected MIDI Song is selected, touching (Information) calls up the Song Information window.

# 3 Return to the Home display, touch at the upper right to expand the Song area, then touch (PLAY/PAUSE) to start playback.



Here and in the later steps, the operation in the Song area of the Home display can be controlled by the SONG CONTROL buttons (page 68).

### Queuing the next Song for playback (MIDI Song only)

While a MIDI Song is playing back, you can queue up the next MIDI Song for playback. This is convenient for chaining it to the next Song smoothly during stage performance. Select the Song you want to play next in the Song Selection display, while a Song is playing back. The [Next] icon appears at the right side of the corresponding Song name. To cancel this setting, touch the [Next] icon.

## 4 Touch [■] (STOP) to stop playback.

### Song Control Operations

To control Song playback, you can use the on-screen buttons called up by touching [▶] in the Song area of the Home display, or use the SONG CONTROL buttons on the panel.

#### NOTE

For instructions on adjusting the tempo, refer to page 40 for MIDI Songs, and page 74 for Audio Songs.

#### Home display



Song Control

#### SONG CONTROL buttons



Keep in mind that, unlike with certain panel button operations, you cannot touch two buttons simultaneously on the display.

#### NOTE

For information about [●] (REC), refer to page 75.

#### ■ Pause

Press (or touch) [▶/||] (PLAY/PAUSE) during playback. Pressing it again resumes Song playback from the current position.

#### ■ Rewind/Fast Forward

Press (or touch) [◀◀] (REW) or [▶▶] (FF) during playback or while the Song stopped. Pressing one of them once moves one measure back/forward for MIDI Songs, or one second for Audio Songs. Holding one of them scrolls backward/forward continuously. When you press (or touch) [◀◀] (REW) or [▶▶] (FF), a setting display appears showing the current position of the Song. The Phrase Mark number appears only when a MIDI Song containing Phrase Marks is selected. You can choose to rewind/fast forward the Song in “Bar” or “Phrase Mark” units by touching the setting display beforehand.

#### NOTE

- The pop-up window mentioned here does not appear when you rewind or fast forward a MIDI Song not having Phrase Marks or an Audio Song by touching on the display.
- Phrase Mark is a pre-programmed marker in certain MIDI Song data, which specifies a specific location in the Song.

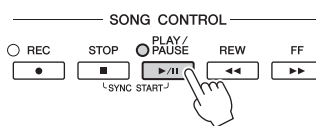

#### For MIDI Songs

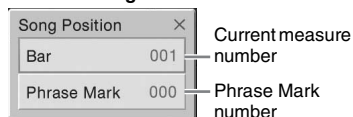

Current measure number  
Phrase Mark number

#### For Audio Songs

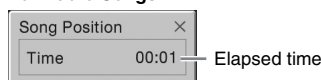

Elapsed time

## Moving the Song Playback Position

In the Song area (when expanded) of the Home display, the current position of the Song playback is shown. This can be moved forward or backward by moving the slider on the display.

### When a MIDI Song is selected:

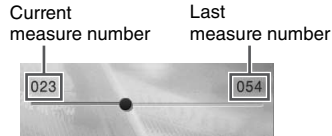

### When an Audio Song is selected:

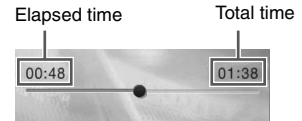

## ■ Synchro Start (MIDI Song)

You can conveniently start playback of a MIDI Song as soon as you start playing the keyboard. While playback is stopped, hold down the SONG CONTROL [STOP] button and press the [PLAY/PAUSE] button. To cancel the Synchro Start function, repeat the same operation.

### NOTE

You can also enable the Synchro Start function by holding [▶/||] (PLAY/PAUSE) in the Song area (when expanded) of the Home display.

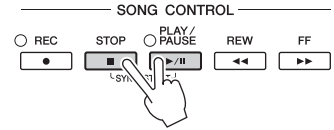

## Displaying Music Notation (Score)

MIDI

Audio

You can view the music notation (score) of the selected Song. We suggest that you read through the music notation before starting to practice.

1 Select a MIDI Song (steps 1 – 2 on page 67).

2 Call up the Score display via [Menu] → [Score].

You can look through the entire notation by touching [◀] or [▶] when the Song playback is stopped. As starting playback, the “ball” bounces along through the score, indicating the current position.



For changing the page.

For changing the settings of the Score display.

### NOTE

- The instrument can display the music notation of commercially available music data or your recorded Songs.
- The displayed notation is generated by the instrument based on the Song data. As a result, it may not be exactly the same as commercially available sheet music of the same song — especially when displaying notation of complicated passages or many short notes.

## Changing the Size of the Score/Displaying Lyrics in a Score

By touching the note icon shown on the lower right of the display, you can change the settings of the Score display, such as changing the size of the score, or displaying note names or lyrics within the score, and so on. For details on the Score display, refer to the Reference manual on the website (page 9).

### NOTE

Lyrics can be shown only when the MIDI song contains lyric data.

## Displaying Lyrics

MIDI

Audio

When the selected Song contains lyric data, you can view it on the instrument's display during playback.

- 1 Select a MIDI Song (steps 1 – 2 on page 67).
- 2 Call up the Lyrics display via [Menu] → [Lyrics].

When the Song data contains lyrics data, the lyrics are shown on the display. You can look through the entire lyrics by touching [◀] or [▶] when Song playback is stopped. As Song playback starts, the color of the lyrics changes, indicating the current position.

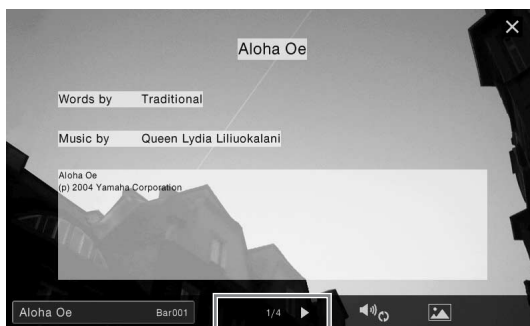

For changing the page.

### NOTE

The Lyrics can be displayed on an external monitor or television (page 95).

For details on the Lyrics display, refer to the Reference manual on the website (page 9).

### Displaying Text

Regardless of whether a Song is selected or not, you can view the text file (.txt) created by using a computer on the instrument's display ([Menu] → [Text Viewer]). This feature enables various useful possibilities, such as the showing of lyrics, chord names, and text notes. For details on the Text display, refer to the Reference manual on the website (page 9).

## One-handed Practice with the Guide Function

MIDI

Audio

You can mute the right-hand part to try practicing that part on your own. The explanations here apply when you practice the right-hand part with “Follow Lights” of the Guide functions. The guide lamps indicate the notes you should play and when you should play them. You can also practice at your own pace — since the accompaniment waits for you to play the notes correctly.

### NOTE

The Guide function is not effective for the Chord section (page 56). As necessary, turn off the [ACMP ON/OFF] button when using it.

- 1 Select a MIDI Song and call up the Score display (page 69).
- 2 Touch  (Playback Settings) to call up the Playback Settings menu.

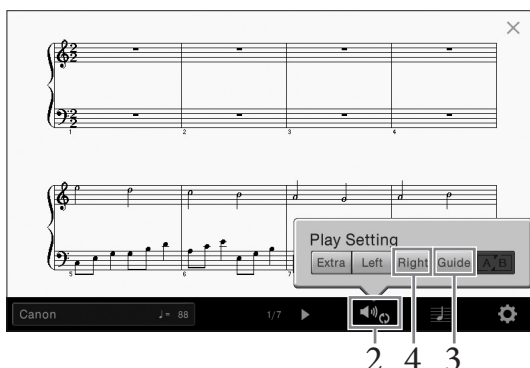

**NOTE**

The Playback Settings can also be controlled from the Home display and Lyrics display.

- 3 Touch [Guide] to turn it on.
- 4 Touch [Right] to turn off the right-hand part.

The right-hand part is muted and the Guide for the right-hand part is enabled.

**NOTE**

Usually, Ch 1 is assigned to [Right], Ch 2 is assigned to [Left], and Ch 3 – 16 are assigned to [Extra]. You can turn each channel on or off from the Mixer display (page 93).

- 5 Press the SONG CONTROL [PLAY/PAUSE] button to start playback.

Practice the right-hand part at your own pace along with the guide lamps. The playback of the Left and Extra parts will wait for you to play the notes correctly.

**NOTE**

The guide lamps light in red for the white keys and in green for the black keys.



After you've finished practicing, touch [Guide] to turn off the Guide function.

**Other guide functions**

In addition to the “Follow Lights” function explained above, there are more functions in the Guide features, for practicing the timing of playing the keys (Any Key mode), for Karaoke or for practicing a song at your own pace (Your Tempo). You can select the functions via [Menu] → [SongSetting] → [Guide] → [Type]. For more information, refer to the Reference Manual on the website (page 9).

# Repeat Playback

MIDI

Audio

The Song Repeat functions can be used to repeatedly play back a Song or a specific range of measures in a Song. This function controlled in the Song area (when expanded) of the Home display is useful for repeated practicing of difficult-to-play phrases.

## NOTE

When a MIDI Song is selected, you can control Repeat playback also on the Playback Settings menu called up from the Score display or Lyrics display (page 71).





## Playing an Entire Song Repeatedly

To repeat an entire Song, turn on  (A-B Repeat) in the display and start playback of the Song. To cancel Repeat playback, turn off  (A-B Repeat).

## Specifying a Range of Measures and Playing them Back Repeatedly (A-B Repeat)

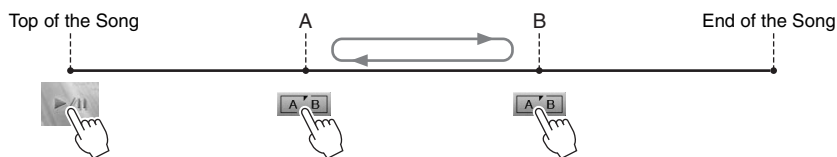

- 1 Select a Song (steps 1 – 2 on page 67).
- 2 Touch  (PLAY/PAUSE) to start playback.
- 3 Specify the repeat range.

When playback reaches the point you want to specify as the starting point (A), turn on  (A-B Repeat). When playback reaches the point you want to specify as the ending point (B), touch  (A-B Repeat) again. The range from Point A to Point B will be played back repeatedly. For MIDI Songs, an automatic lead-in (to help guide you into the phrase) is added before Point A.





## NOTE

- When you want to repeat from the top of the song to somewhere in the middle of the song:
  1. Turn on the A-B Repeat icon, then start Song playback.
  2. Touch the A-B Repeat icon again at the desired ending point (B).
- Specifying only Point A results in repeat playback between Point A and the end of the Song.

- 4 Touch  (Stop) to stop playback. The Song position will return to Point A. After your practice, turn off  (A-B Repeat).



### Specifying the repeat range while Songs are stopped

1. Fast-forward the Song to Point A then turn on  (A-B Repeat).
2. Fast-forward the Song to Point B then touch  (A-B Repeat) again.

## Playing Multiple Songs Repeatedly

You can play several songs repeatedly. Select “All” in “Repeat Mode” ([Menu] → [Song Setting] → [Play]), then touch  (PLAY/PAUSE) to start playback. All Songs saved in a designated folder will then be played repeatedly in order. To reset the repeat setting, select “Off” in “Repeat Mode” ([Menu] → [Song Setting] → [Play]).

### NOTE

The preset Songs in the “Follow Lights” folder contain Guide settings, and as such are inappropriate for use with “All” repeat.

## Adjusting the Pitch in Semitones (Pitch Shift)

MIDI

Audio

Like the Transpose function (page 41) of the MIDI Song, the pitch of an Audio Song in the USB flash drive can be adjusted in semitone steps (from -12 to 12) on the Home display.

- 1 Connect the USB flash drive containing Audio Songs to the [USB TO DEVICE] terminal.

### NOTE

Before using a USB flash drive, be sure to read “Connecting USB Devices” on page 97.

- 2 Select an Audio Song (steps 1 – 2 on page 67).
- 3 In the Song area (when expanded) of the Home display, touch  0 (Pitch Shift) to call up the Setup window.

### NOTE

Pitch Shift cannot be applied to MP3 files of 48.0 kHz sample rate.





- 4 Set the value by touching /[▶].

## Adjusting the Playback Speed (Time Stretch)

MIDI

Audio

Like Tempo adjustment of a MIDI Song (page 40), you can adjust the playback speed of an Audio Song in USB flash drive by stretching or compressing it.

To do this, select an Audio Song then touch  100% (Time Stretch) in the Song area of the Home display to call up the Setup window. Touch []/[] in this window to set the value (from 70% to 160%). Higher values result in a faster tempo.



### NOTE

Playback speed cannot be changed for MP3 files of 48 kHz sampling rate.

## Canceling the Vocal Part (Vocal Cancel)

MIDI

Audio

You can cancel or attenuate the center position of the stereo sound. This lets you sing “karaoke” style with just instrumental backing, or play the melody part on the keyboard, since the vocal sound is usually at the center of the stereo image in most recordings.

To turn the Vocal Cancel function on/off, first select an Audio Song, then turn on/off  (Vocal Cancel) in the Song area of the Home display.



### NOTE

- Though the Vocal Cancel function is highly effective on most audio recordings, the vocal sound on some songs may not be completely cancelled.
- Vocal cancel does not affect the sound from the [AUX IN] jack.

# Song Recording

– Recording Your Performance –

This instrument allows you to record your performance in the following two methods.

## • MIDI recording

With this method, recorded performances are saved to the instrument or a USB flash drive as an SMF (format 0) MIDI file. If you want to re-record a specific section or change Voices and edit other parameters, use this method. Also if you want to record your performance to each channel one by one, execute Multi Track Recording of the MIDI recording method. Since a MIDI Song can be converted to an Audio Song after recording (page 81), you may want to use MIDI recording (with overdubbing and multiple parts) to first create a complex arrangement you would not otherwise be able to play live, then convert it to an Audio Song. This instrument allows you to record approximately 300 KB per Song.

## • Audio recording

With this method, recorded performances are saved to a USB flash drive as an Audio file. Recording is done without designating the recorded part. Since it is saved in stereo WAV format of normal CD quality resolution (44.1kHz/16-bit) by default, it can be transmitted to and played on portable music players by using a computer. The file format can be changed to MP3 via [Menu] → [SongSetting] → [Rec] → [Audio Rec Format]. This instrument allows you to record up to 80 minutes per single recording.

## Basic Procedure for Recording (MIDI/Audio Recording)

Before recording, make the necessary settings such as Voice/Style selection (for MIDI Recording and Audio Recording) and the microphone connection (only for Audio Recording, if you want to record your vocal). As necessary, connect the USB flash drive to the [USB TO DEVICE] terminal, especially if you want to execute Audio Recording.

### NOTE

- Before using a USB flash drive, be sure to read "Connecting USB Devices" on page 97.
- You can record your performance using an Audio Style when recording the audio in WAV format, but not in MP3 format. Also, if you record the song using MIDI recording, the audio part cannot be recorded. Only in the Piano Room, however, the audio part can be recorded by using MIDI recording (page 47).

### Before starting Audio Recording:

Recorded data via Audio can only be saved to USB flash drive. If you want to execute Audio Recording, make sure to connect the USB flash drive beforehand.

- 1 On the Home display, touch [▶] at the upper right to expand the Song area, then touch [●] (Rec) to call up the Song Recording window.

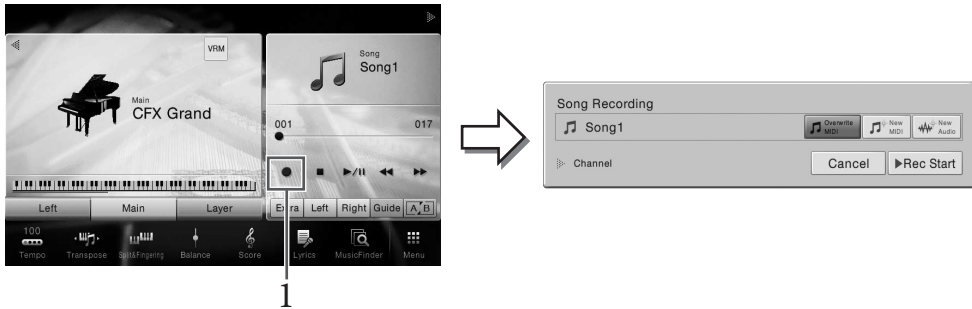

**NOTE**

- The contents of the Song Recording window differ depending on the panel settings.
- Here and in the later steps, the operation in the Song area of the Home display can be controlled by the SONG CONTROL buttons (page 68).

- 2 Touch [New MIDI] or [New Audio] to select the desired type of recording.

If you want to cancel recording, touch [Cancel] in the display or press the SONG CONTROL [REC] button.

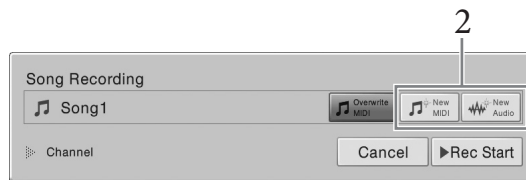

**NOTE**

[Overwrite MIDI] appears only when a MIDI Song has been selected before starting recording.

- 3 Start Recording.

With MIDI Recording, you can start recording either by playing the keyboard or touching [Rec Start]. With Audio Recording, start recording by touching [Rec Start].

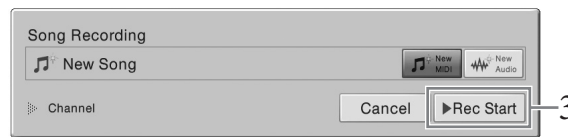

You can also start recording by pressing the SONG CONTROL [PLAY/PAUSE] button.

**Part Assignment to Channels (MIDI Recording)**

With MIDI Recording, you can record your performance to each channel one by one (page 78). When you execute MIDI Recording without specifying the part as explained here, the keyboard parts will be recorded to channels 1 – 3 and the Style parts will be recorded to channels 9 – 16.

- 4 Play the keyboard.

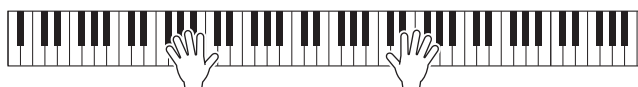

- 5 After you finish your performance, touch [■] (Stop) on the Home display to stop recording.



- 6 To hear the recorded performance, touch [▶/||] (Play/Pause).

- 7 Save the recorded performance.

#### ■ In MIDI Recording

After recording,  (Save) appears in the Song area of the Home display. This icon indicates that recorded data exists but has not yet been saved.

#### **NOTICE**

The recorded MIDI Song will be lost if you change to another Song or you turn the power off without executing the save operation.

- 7-1 On the Home display, touch  (Save) shown in the Song area.

The Song Selection display appears for selecting a destination to save the recorded Song.

- 7-2 Save the recorded data as a file by following the instructions on page 33, steps 2 – 5.

MIDI Songs can be saved to  (User MIDI Song tab).

#### ■ In Audio Recording

Since the Audio Song file is automatically saved to the USB flash drive while recording, the Save operation is not required. The recorded Audio Song will appear in the  (User Audio Song tab) on the Song Selection display. If desired, rename the file name by following the instructions on page 34.

### When you want to re-record an already recorded MIDI Song:

You can overwrite an already recorded MIDI Song. To do this, select the desired MIDI Song (steps 1 – 2 on page 67), then start recording. In step 2 on page 76, confirm that [Overwrite MIDI] is selected, and go on to step 3.

## Recording to Specified Channels (MIDI Recording)

With MIDI Recording, you can create a MIDI Song consisting of 16 channels by recording your performance to each channel one by one. In recording a piano piece, for example, you can record the right-hand part to channel 1 then record the left-hand part to channel 2, allowing you create a complete piece which may be difficult to play live with both hands together. To record a performance with Style playback, for example, record the Style playback to channels 9 – 16, then record melodies to channel 1 while listening to the already recorded Style playback. In this way, you can create an entire Song which would otherwise be difficult, or even impossible, to play live.

- 1 If you want to re-record an existing MIDI Song, select the desired Song (steps 1 – 2 on page 67).

If you want to record from scratch, skip this step.

- 2 On the Home display, touch [▶] at the upper right to expand the Song area, then touch [●] (Rec) to call up the Song Recording window.

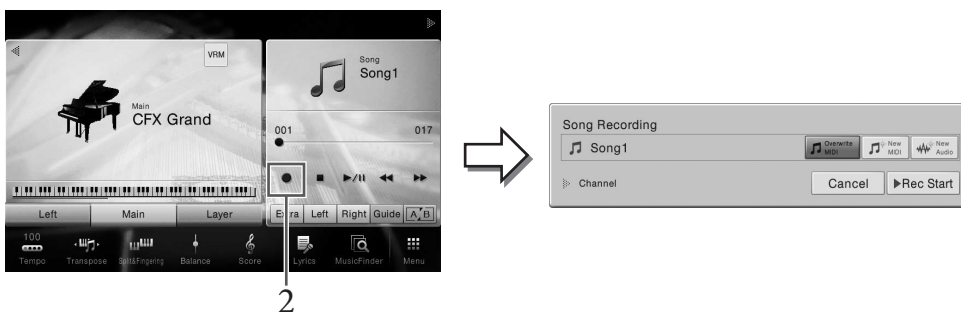

### NOTE

- The contents of the Song Recording window differ depending on the panel settings.
- Here and in the later steps, the operation in the Song area of the Home display can be controlled by the SONG CONTROL buttons (page 68).

- 3 When recording from scratch, touch [New MIDI]. When re-recording an existing MIDI Song, confirm that [Overwrite MIDI] is selected and go to step 4.



- 4 Touch [▶] at the left of “Channel” to expand the Channel area.

## 5 Specify the target channel and part for recording.

5-1 From the display, set the part or parts you intend to record to [Rec], and set all other parts to [Off].

5-2 Touch the channel number under the part(s) you set to [Rec] in step 5-1. In the setting display that appears, specify the channel (1 – 16) for recording.

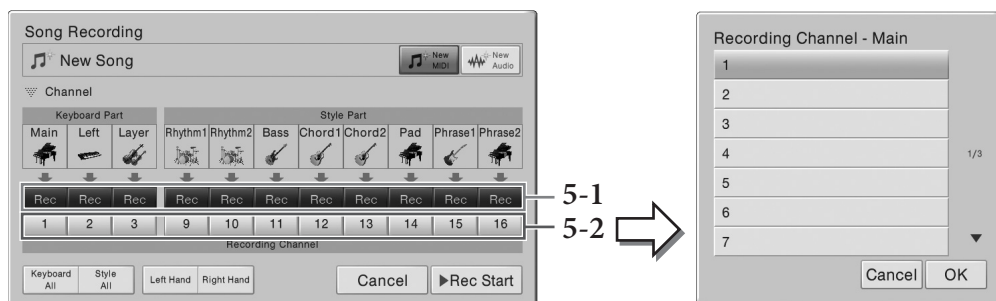

### NOTICE

Previously recorded data will be overwritten if you set channels which have recorded data to [Rec].

### NOTE

- Multiple parts can not be recorded to one channel.
- If you want to cancel recording, touch [Cancel] in the display or press the SONG CONTROL [REC] button before going on to step 6.
- The Main, Layer and Left parts are assigned to channels 1 – 3 respectively by default, though you can change the assignment on the display called up via [Menu] → [SongSetting] → [Part Ch].

To make the settings quickly, simply select the keyboard part ([Keyboard All], [Style All], [Left Hand] or [Right Hand] located at the bottom left).

- **Keyboard All:** You can turn all of the Keyboard parts (Main, Left and Layer) [Rec] or [Off] together. The Main part, Left part and Layer part will be recorded to channels 1 – 3 by default.
- **Style All:** You can turn all of the Style parts [Rec] or [Off] together. The Style parts will be recorded to channels 9 – 16 by default.
- **Right Hand:** This can be selected when recording only the right-hand part. The Main part of the Voice will be recorded to channel 1, and the Layer part will be recorded to channel 3.
- **Left Hand:** This can be selected when recording only the left-hand part. The Left part of the Voice will be recorded to channel 2. When the Left part of the Voice is off, the Main part will be recorded to channel 2 and the Layer part will be recorded to channel 4.

## 6 Play the keyboard to start recording.

You can also start recording by touching [Rec Start] or pressing the SONG CONTROL [PLAY/PAUSE] button.

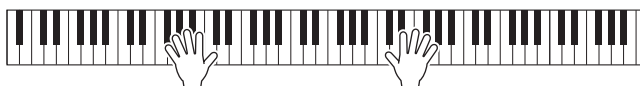

- 7 After you finish your performance, touch [■] (Stop) on the Home display to stop recording.



- 8 To hear the recorded performance, touch [▶/||] (Play/Pause).

- 9 Record your performance to another Channel by repeating steps 2 – 8.

In step 3, confirm that [Overwrite MIDI] is selected. In step 5, select a Channel which has no recorded data. In step 6, play the keyboard while listening to the already recorded data.

**NOTE**

When recording another channel, you can turn already recorded channels on or off in the Mixer display (page 93).

- 10 Save the recorded performance.

- 10-1 On the Home display, touch [📁] (Save) shown in the Song area.

The Song Selection display appears for selecting a destination to save the recorded Song.

- 10-2 Save the recorded data as a file by following the instructions on page 33, steps 2 – 5.

**NOTICE**

The recorded MIDI Song will be lost if you change to another Song or you turn the power off without executing the Save operation.

For details about how to record the right- and left-hand parts separately, as well as how to record first a Style and then a melody, refer to the Reference Manual on the website (page 9).



## Converting a MIDI Song to an Audio Song

You can convert a recorded MIDI Song in the User memory or USB flash drive to an Audio Song. Conversion is executed by playing back the MIDI Song and re-recording it as an Audio Song. By default, the converted data is saved in WAV format, in the same way as Audio recording (page 75).

- 1 **Connect the USB flash drive (to which the Audio Song is to be saved) to the [USB TO DEVICE] terminal.**

**NOTE**

Before using a USB flash drive, be sure to read "Connecting USB Devices" on page 97.

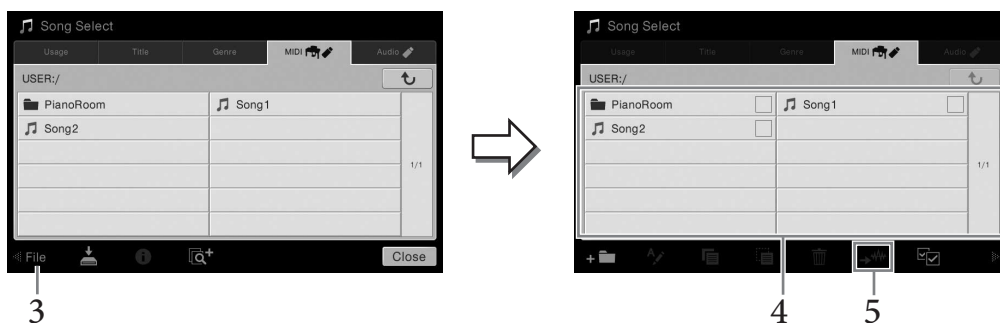

- 2 **Call up the Song Selection display which contains the MIDI Song to be converted.**
- 3 **Touch [File] to call up the File Management icons.**



- 4 **Enter a checkmark to the MIDI Song to be converted.**

**NOTE**

Audio Conversion can only be done one file at a time.

- 5 **Touch  (Audio Convert) to call up the Song Selection display for selecting the Save destination.**
- 6 **Specify the Save destination location.**  
You can add a new folder by touching  (New Folder)
- 7 **Touch [Convert] to start conversion.**

This operation starts playback and conversion from MIDI to audio. If you play the keyboard or input audio signals via a microphone or the [AUX IN] jack during conversion, these sounds will also be recorded.

When conversion is completed, the message indicating that the conversion is being executed will no longer be shown in the display, and the newly created new Audio Song is shown in the Song Selection display.

# Microphone

## – Adding Vocal Harmony Effects to Your Singing –

By connecting a microphone to the [MIC/LINE IN] jack (standard 1/4" phone jack), you can enjoy singing along with your keyboard performance or with Song playback. The instrument outputs your vocals through the built-in speakers. Moreover, you can automatically apply various Vocal Harmony effects to your voice as you sing.

### Connecting a Microphone

- 1 Before turning on the power of the instrument, set the [INPUT VOLUME] knob to the minimum position.

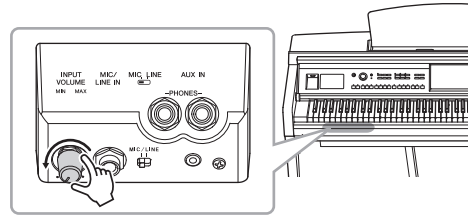

- 2 Connect the microphone to the [MIC/LINE IN] jack.

#### NOTE

Make sure you have a conventional dynamic microphone.

- 3 Set the [MIC/LINE] switch to “MIC.”

- 4 Turn on the power of the instrument.

- 5 (If necessary, turn on the microphone.)  
Adjust the [INPUT VOLUME] knob while singing into the microphone.

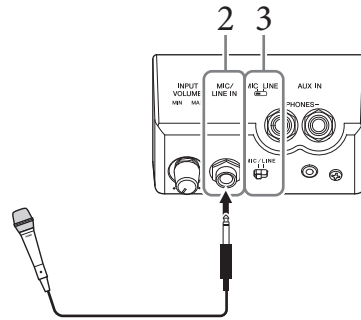

Adjust the control while checking the [MIC] lamp on the panel. Make sure to adjust the control so the lamp lights in green. Make sure that the lamp does not light in red, since this indicates that the input level is too high.

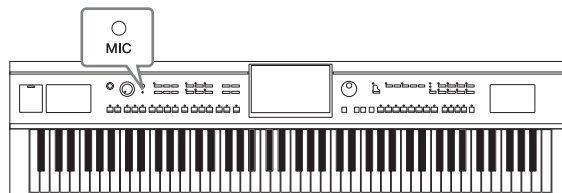

- 6 On the Balance display ([Menu] → [Balance]), adjust the volume balance between the microphone sound and the instrument sound (page 42).

#### Disconnecting the microphone

1. Set the [INPUT VOLUME] knob to the minimum position.
2. Disconnect the microphone from the [MIC/LINE IN] jack.

#### NOTE

Before turning the power off, make sure to set the [INPUT VOLUME] knob to the minimum position.

# Applying Vocal Harmony Effects to Your Voice

The Vocal Harmony feature lets you add harmonies to your singing voice, input via the microphone sound.

- 1 Connect the microphone to the instrument (page 82).
- 2 Call up the Vocal Harmony display via [Menu] → [VocalHarmony].

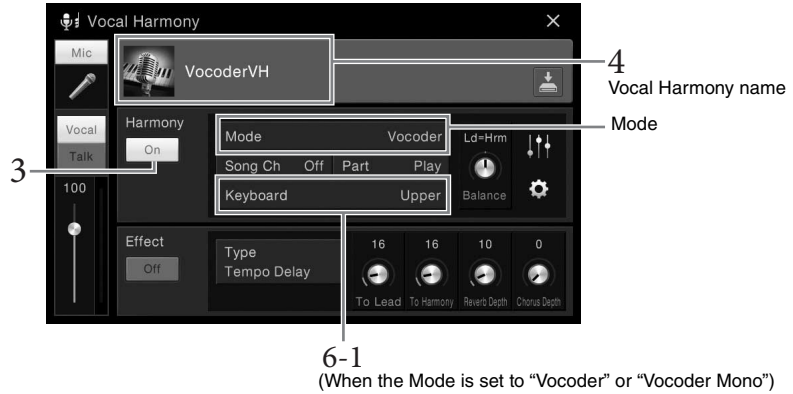

**NOTE**

The display shown at left is called up when the Harmony Mode is set to "Vocoder." A different display appears when the Harmony Mode is set to "Chordal."

- 3 Make sure that Harmony is set to "On."
- 4 Touch the Vocal Harmony name to call up the Vocal Harmony Selection display.
- 5 Select a Vocal Harmony type.

The Vocal Harmony features three different Modes which can be selected automatically by selecting a Vocal Harmony type.

**Harmony mode**

<b>Chordal</b>	The harmony notes are determined by the chords you play in the chord section (with [ACMP ON/OFF] turned on), the left hand section (with [ACMP ON/OFF] turned off and the Left part turned on) or chord data of Song.
<b>Vocoder</b>	The microphone sound is output via the notes you play on the keyboard or the Song playback notes.
<b>Vocoder-Mono</b>	Same as the Vocoder basically. In this mode, only single-note melodies or lines can be played back (with last-note priority).

Icons shown in the Vocal Harmony Selection display indicate the following meanings.

(Blue/pink)	Vocal Harmony Type of Chordal Mode In general, blue icon types are to be used by male singers, and pink by female singers.
	Vocal Harmony Type of Vocoder Mode
	Vocal Harmony Type having unusual effects, such as a robotic voice.
(Gray)	Vocal Harmony Type without any effect.

## 6 Follow the steps below, depending on which Type (and mode) you selected.

### ■ If you selected the Chordal Type:

**6-1 Make sure that the [ACMP ON/OFF] button is turned on.**

**6-2 Play back a Style, or play back a Song which contains chords.**

Vocal harmonies based on the chords are applied to your singing.

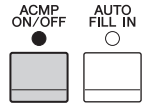

### ■ If you selected the Vocoder or Vocoder-Mono Type:

**6-1 As necessary, change the “Keyboard” setting to “Off,” “Upper,” or “Lower.”**

When “Upper” or “Lower” is selected, playing the right-hand or left-hand section of the keyboard will control the Vocoder effect. When “Off” is selected, playing the keyboard will not control the Vocoder effect.

**6-2 Play melodies on the keyboard or play back a Song, and sing into the microphone.**

You’ll notice that you don’t actually have to sing pitched notes. The Vocoder effect takes the words you say and applies them to the pitch of the instrument sounds.

#### Useful functions for Karaoke

- Lyrics on the display ..... page 70
- Transpose, Pitch Shift ..... pages 41, 73
- Vocal Cancel ..... page 74

## Using the Talk Function

This function lets you instantly change the microphone settings for talking or making announcements between song performances.

To call up the Talk setting, touch [Talk] located at the left on the Vocal Harmony display.

To recall the Vocal Harmony settings, touch [Vocal] and turn it on.

### NOTE

You can adjust the microphone settings for Talk on the Mic Setting display called up via [Menu] → [MicSetting].

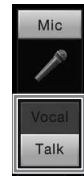

To get the most convenient use of this function, assign one of the pedals (Left, Center, or AUX) to “Talk” ([Menu] → [Assignable] → [Pedal]). For details, refer to the Reference Manual on the website (page 9).

# Music Finder

– Calling up Ideal Panel Setups for Your Performance –

This feature lets you call up panel settings ideal for your performance simply by selecting a “Record,” which includes Voice and Style settings. If you want to play a certain piece of music but don’t know which Style and Voice settings would be appropriate, you can search for relevant Records by the title of the piece.

## Selecting the Desired Record (Panel Settings)

This lets you use the convenient Music Finder functions with preset sample records.

### 1 Call up the Music Finder display via [Menu] → [MusicFinder].

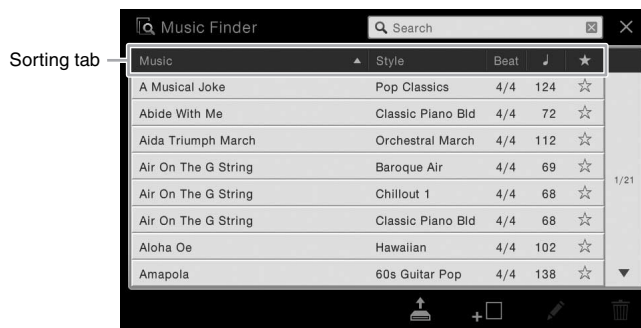

### 2 Touch the desired Record.

The panel settings in the Record are called up. When the Record including the Style name is selected, ACMP and SYNC START are turned on and the corresponding Style is called up. This lets you start Style playback immediately.

If searching for the desired Record is difficult, use the Sort function described below.

#### Sorting the Records

Touch one of the Sorting tabs to sort the Records in the corresponding order. Touch the same tab to alternate the order, ascending or descending.

- **Music**  
Sorts the Records title of the music piece.
- **Style**  
Sorts the Records by Style name.
- **Beat**  
Sorts the Records by beat.
- **♩ (Tempo)**  
Sorts the Records by tempo.

#### ★ (Favorite)

Touching here shows only the Favorite Records. To show all the Records, touch here again. To add a Record to Favorite, touch the star mark (☆) of the desired Record to make it colored (★). To delete it from Favorite, touch the colored star mark (★).

### 3 Play the Style by specifying the chords with your left hand and play the melody with your right.

You can download records from the Yamaha website and load them to the instrument (page 87).

#### NOTE

If you want to avoid changing the Tempo during Style playback when selecting another Record, set the "Tempo" parameter to "Hold" or "Lock" on the display called up via [Menu] → [StyleSetting] → [Change Behavior]. When set to "Lock," the tempo will be locked while stopping as well as playing.

## Searching for Records (Panel Settings)

You can also search for Records by specifying a song title or keyword, using the Search function of Music Finder.

### 1 Call up the Music Finder display via [Menu] → [MusicFinder].

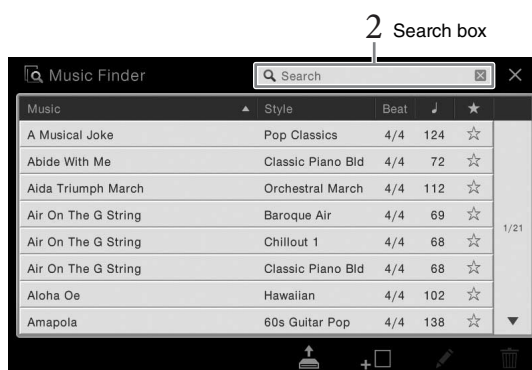

### 2 Touch the Search box to call up the Character Entry window.

### 3 Enter the keyword for searching (page 37) to start Search.

If you want to input two or more keywords, insert a space between each word.

After the Search is completed, the resulting Record list appears. If no Records are listed, try this step again with another keyword.

### 4 Select the desired Record.

To clear the result and show all Records in the Music Finder, touch [X] in the Search box.

### 5 Play the Style by specifying the chords with your left hand and playing the melody with your right.

#### Registering a Song or Style to a Record

By registering Song or Style files in various locations (Preset, User and USB) into Music Finder, you can easily call up your favorite files. For details about registering files to a record, refer to the Reference Manual on the website (page 9).

## Downloading Records (panel settings) from the website

As a factory default, some sample Records (panel settings) are provided in the Music Finder. To use the Music Finder function more conveniently and effectively, we recommend that you download the Records (panel settings) from the Yamaha website, and load them to this instrument.

- 1 On the computer, access the following website and download the Music Finder file (\*\*\*.mfd) to the USB flash drive connected to the computer.

<http://download.yamaha.com/>

### NOTE

Before using a USB flash drive, be sure to read "Connecting USB Devices" on page 97.

- 2 Connect the USB flash drive containing the Music Finder file (\*\*\*.mfd) to the [USB TO DEVICE] terminal of this instrument.
- 3 Call up the Music Finder display via [Menu] → [MusicFinder].

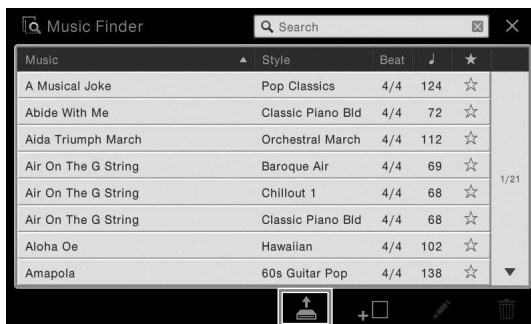

- 4 Touch  (Load) to call up the File Selection display.
- 5 Select the desired Music Finder file in the USB flash drive to call up a message prompting you to select "Replace" or "Append."
- 6 Touch [Append] if you want to add Records of the selected Music Finder file, or touch [Replace] if you want to replace all Records with the new ones.
- 7 Touch [Yes] in response to the confirmation message.

# Registration Memory

– Saving and Recalling Custom Panel Setups –

The Registration Memory function allows you to save (or “register”) virtually all panel settings to a Registration Memory button, and then instantly recall your custom panel settings by simply pressing a single button. The registered settings for eight Registration Memory buttons should be saved as a single Bank (file).

## Registering Your Panel Setups

- 1 Set up the panel controls (such as Voice, Style and so on) as desired.**  
Refer to the separate Data List for a list of parameters that can be registered with the Registration Memory function.
- 2 Press the [MEMORY] button in the REGISTRATION MEMORY section to call up the Registration Memory window.**

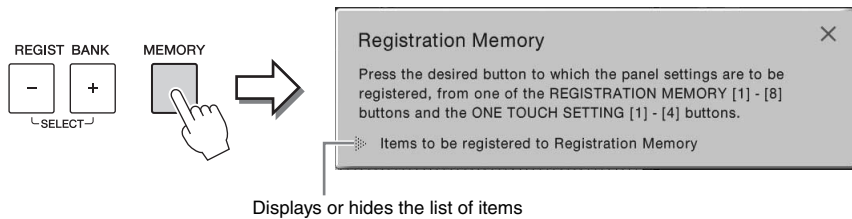

### Selecting the items to be registered

Touching [▶] at the bottom left of the window calls up the list for selecting the items to be registered. Before going on to step 3, enter or remove checkmarks by touching the desired items. Items having checkmarks will be registered.

- 3 Press the desired REGISTRATION MEMORY [1] - [8] button to which you wish to memorize the panel setup.**

Memorized buttons are lit in red, indicating that the number button contains data and its number is selected.

#### NOTICE

If you select the button whose lamp is lit in red or green here, the panel setup previously memorized to the button will be erased and replaced by the new settings. Hence, you should memorize panel setups only to buttons that are turned off.

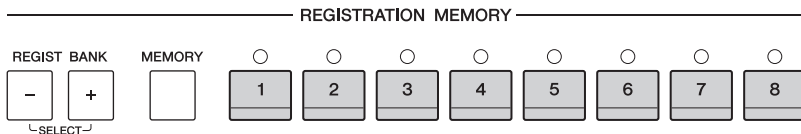

### About the lamp status

- **Red:** Data registered and currently selected
- **Green:** Data registered but not currently selected
- **Off:** No data registered



#### 4 Register various panel setups to other buttons by repeating steps 1 – 3.

The registered panel setups can be recalled by simply pressing the desired number button.

#### NOTE

You can also disable recall of specific item(s) when calling up the registered panel setups: [Menu] → [RegistFreeze].

## Saving the Registration Memory as a Bank File

You can save all eight registered panel setups as a single Registration Memory Bank file.

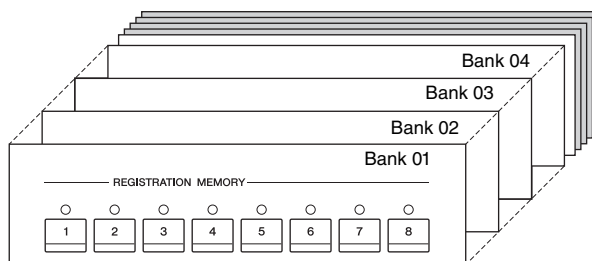

- 1 On the Home display, touch [▶] at the upper right corner to show the Registration area, then touch the area to call up the Registration Bank Selection display.

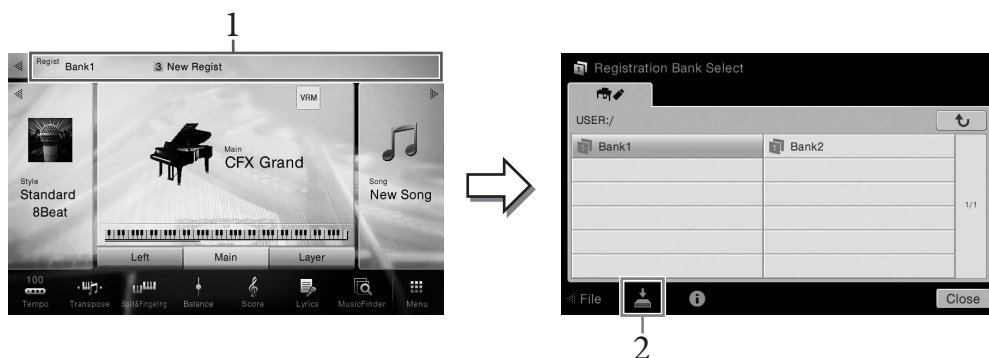

#### NOTE

In general, Registration Memory data (Bank files) is compatible among the models CVP-709/705/701. However, the data may not be perfectly compatible, depending on the specifications of each model.

This display can be called up also by pressing the REGIST BANK [+] and [-] buttons simultaneously.

- 2 Touch  (Save) to save the Bank file.

For instructions on saving, refer to page 33.

## Recalling a Registered Panel Setup

The saved Registration Memory Bank files can be recalled by using the REGIST BANK [-]/[+] buttons or the following procedure.

### NOTE

- When recalling setups that include Song, Style or text files selected from a USB flash drive, make sure that the appropriate USB flash drive containing the registered Song, Style or text is connected into the [USB TO DEVICE] terminal.
- Before using a USB flash drive, be sure to read “Connecting USB Devices” on page 97.
- You can also call up the eight setups by using pedals in any order you specify via [Menu] → [RegistSeq]. For details, refer to the Reference Manual on the website (page 9).

- 1 Call up the Registration Bank Selection display (step 1 on page 89).
- 2 Touch and select the desired Bank on the display.  
You can also use the REGIST BANK [-]/[+] buttons to select a Bank.
- 3 Press one of the green-lit numbered buttons ([1] – [8]) in the Registration Memory section.

## Confirming the Registration Memory Information

You can call up the information display to confirm which Voices and Style are memorized to the [1] – [8] buttons of a Registration Memory Bank.

- 1 Call up the Registration Bank Selection display, then select the desired Bank.
- 2 Touch **i** (Information) to call up the Registration Information window.  
This display consists of two pages: Voice-related and Style-related. You can alternate between the two via [▶]/[◀].

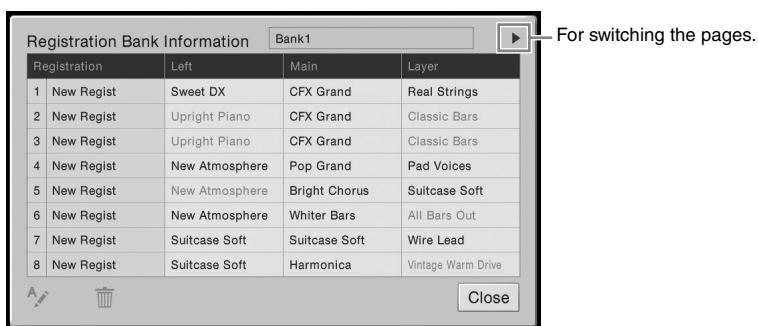

### NOTE

If a certain Voice part is set to off, the Voice name for the corresponding part is shown in gray.

To change the name of the selected Registration, touch **A** (Rename). To delete the selected Registration, touch **🗑** (Delete).

### Naming the Registration Memory data

If you have created a wide variety of Registration Setups, it may be difficult to find the one desired for your particular live performance situation.

To remedy this, it is good idea to assign names to both the Registration Memory Bank and its Registration Setups individually.

# Mixer

## – Editing the Volume and Tonal Balance –

The Mixer gives you intuitive control over aspects of the keyboard parts and Song/Style channels, including volume balance and the timbre of the sounds. It lets you adjust the levels and stereo position (pan) of each Voice to set the optimum balance and stereo image, and lets you set how the effects are applied. This chapter covers the basic procedures for the Mixer. For details, refer to the Reference Manual on the website (page 9).

### Basic Procedure for the Mixer

- 1 Call up the Mixer display via [Menu] → [Mixer].

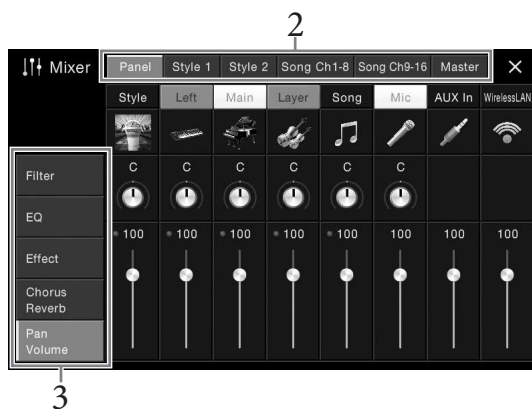

- 2 Touch a tab for editing the balance between the desired parts.

<p><b>Panel</b></p>	<p>Use this display when you want to adjust the balance between the entire Song part, entire Style part, Mic part, Aux In part, Main part, Layer part, Left part and the USB wireless LAN adaptor part if one is connected.</p> <p><b>NOTE</b> A USB wireless LAN adaptor may not be included depending on your area.</p>
<p><b>Style1</b> (for CVP-709) <b>Style</b> (for CVP-705)</p>	<p>Use this display when you want to adjust the balance between the parts of the Style.</p> <ul style="list-style-type: none"> <li>• <b>Rhythm1, Rhythm2</b> These are the basic parts of the Style, containing the drum and percussion rhythm patterns.</li> <li>• <b>Bass</b> The bass part uses various appropriate instrument sounds to match the Style.</li> <li>• <b>Chord1, Chord2</b> These comprise the rhythmic chord backing, commonly consisting of piano or guitar Voices.</li> <li>• <b>Pad</b> This part is used for sustained instruments such as strings, organ, choir, etc.</li> <li>• <b>Phrase1, Phrase2</b> These parts are used for punchy brass stabs, arpeggiated chords, and other extras that make the accompaniment more interesting.</li> </ul>

<b>Style2</b> (CVP-709 only)	<ul style="list-style-type: none"> <li>• <b>Rhythm1, Rhythm2</b> These are the same as Rhythm1, Rhythm2 of Style1.</li> <li>• <b>Audio</b> This is the Audio part of an Audio Style (page 57).</li> </ul>
<b>Song Ch1-8 / 9-16</b>	Use this display when you want to adjust the balance between all the parts of the MIDI Song. This is available only when a MIDI Song is selected.
<b>Master</b>	Unlike the other displays, use this display when you want to adjust the tonal characteristics of the entire sound (except for Audio Songs) of this instrument.

### 3 Touch a tab for editing the desired parameters.

■ When a tab other than “Master” is selected in step 2:

<b>Filter</b>	For adjusting the Harmonic Content (resonance) and sound brightness.
<b>EQ</b>	For adjusting equalization parameters to correct the tone or timbre of the sound.
<b>Effect</b>	For selecting an Effect type and adjusting its depth for each part.
<b>Chorus/Reverb</b>	For selecting a Chorus/Reverb type and adjusts its depth for each part.
<b>Pan/Volume</b>	For adjusting panning and volume for each part.

■ When “Master” is selected in step 2:

<b>Compressor</b>	Lets you turn the Master Compressor (which is applied to the entire sound) on or off, select the Master Compressor type, and edit the related parameters. Your original edits can be saved as the Master Compressor type.
<b>EQ</b>	Lets you select the Master EQ type applied to the entire sound and edit the related parameters. Your original edits can be saved as the Master EQ type.

### 4 Set the value of each parameter.

**NOTE**

To reset each parameter to the default value, touch the number value or setting and hold it.

### 5 Save your Mixer settings.

■ To save the Panel Mixer settings:

Register them to Registration Memory (page 88).

■ To save the Style1/2 (CVP-709) or Style (CVP-705) Mixer settings:

Save them as a Style file to the User memory or USB flash drive. If you want to recall the settings for future use, select the Style file saved here.

1. Call up the operation display via [Menu] → [StyleCreator].
2. Touch  (Save) to call up the Style Selection display, then save as a Style file (page 33).

■ To save the Song Ch 1-8/9-16 Mixer settings:

First register the edited settings as part of the Song data (Setup), then save the Song to the User memory or USB flash drive. If you want to recall the settings for future use, select the Song file saved here.

1. Call up the operation display via [Menu] → [SongCreator] → [Channel Edit].

2. Touch [Setup].
3. Touch [Execute] to execute the Setup.
4. Touch  (Save) to call up the Song Selection display, then save as a Song file (page 33).

■ **To store the Master Mixer settings:**

Your original edits can be stored as a Master Compressor type and Master EQ type. If you want to recall the settings for future use, select the corresponding type at the upper right of each display.

1. Touch  (Save) in the “Compressor” display or “EQ” display.
2. Select one of USER1 – USER5 in the “Compressor” display or USER1 – USER2 in the “EQ” display, then touch [Save] to call up the Character Entry window.
3. On the Character Entry window, change the name as necessary, then touch [OK] to save the data.

## Turning Each Channel of the Style or Song On/Off

The Mixer display lets you turn each channel of the current Style or Song on or off.

- 1 In the Mixer display, touch the [Style1/2] (CVP-709) or [Style] (CVP-705) tab, [Song Ch 1-8] tab or [Song Ch 9-16] tab.
- 2 Touch the Channel which you want to turn on or off.



If you want to solo a specific channel, touch and hold the desired channel until the number turns green. To cancel solo, simply touch the (green) channel number again.

**To change the Voice for each channel:**

Touch the instrument icon below the channel number to call up the Voice Selection display, then select the desired Voice.

**NOTE**

(CVP-709 only) The Voice of the Audio part of the Audio Style cannot be changed.

- 3 As necessary, make other settings then save them as a Style file or Song file (step 5 on page 92).

# Connections

## – Using Your Instrument with Other Devices –

### ⚠ CAUTION

Before connecting the instrument to other electronic components, turn off the power of all the components. Also, before turning any components on or off, make sure to set all volume levels to minimum (0). Otherwise, damage to the components, electrical shock, or even permanent hearing loss may occur.

## I/O Connectors

To see where these connectors are located on the instrument, refer to page 15.

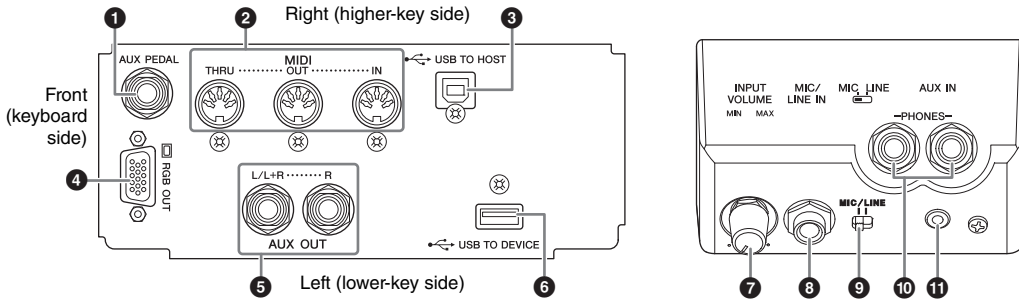

- |   |   |
|---|---|
| <ul style="list-style-type: none"> <li>❶ [AUX PEDAL] jack ..... page 96</li> <li>❷ MIDI terminals ..... page 99</li> <li>❸ [USB TO HOST] terminal ..... page 99</li> <li>❹ [RGB OUT] terminal ..... page 95</li> <li>❺ AUX OUT [L/L+R]/[R] jacks ..... page 94</li> <li>❻ [USB TO DEVICE] terminal ..... page 97</li> </ul> | <ul style="list-style-type: none"> <li>❼ [INPUT VOLUME] knob ..... page 82</li> <li>❽ [MIC/LINE IN] jack ..... pages 82 and 96</li> <li>❾ [MIC/LINE] switch ..... pages 82 and 96</li> <li>❿ [PHONES] jacks ..... page 21</li> <li>⓫ [AUX IN] jack ..... page 94</li> </ul> |
|---|---|

## Connecting Audio Devices ([AUX IN] jack, AUX OUT [L/L+R]/[R] jacks)

### Playing a Portable Audio Player with the Built-in Speakers

You can connect the headphone jack of a portable audio player to the instrument's [AUX IN] jack, letting you hear the sound of that audio player through the built-in speakers of the instrument.

#### NOTICE

To avoid damage to the devices, first turn on the power to the external device, then to the instrument. When turning off the power, first turn off the power to the instrument, then to the external device.

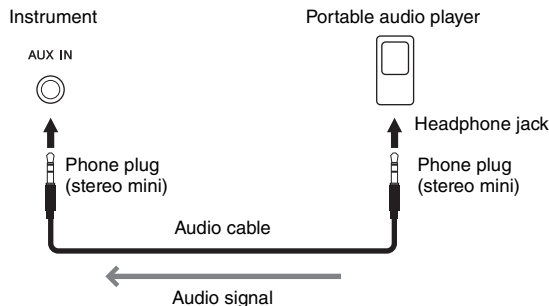

#### NOTE

- Use audio cables and adaptor plugs having no (zero) resistance.
- You can adjust the volume of the sound from the [AUX IN] jack in the Balance display (page 42).

### Minimizing noise of the input sound via Noise Gate

By default, this instrument cuts unwanted noise from the input sound. However, this may result in wanted sounds also being cut, such as the soft decay sound of a piano or acoustic guitar. To avoid this, set the Noise Gate to off via [Menu] → [Utility] → [Speaker/Connectivity] → [AUX In Noise Gate].

## Using an External Stereo System for Playback

You can connect a stereo system to amplify the instrument's sound by using the AUX OUT [L/L+R]/[R] jacks. The microphone or guitar sound connected to the instrument's [MIC/LINE IN] jack is output at the same time.

### NOTICE

- To avoid possible damage, first turn on the power to the instrument, then to the external device. When turning off the power, first turn off the power to the external device, then to the instrument. Since this instrument's power may automatically be turned off due to the Auto Power Off function (page 19), turn off the power to the external device, or disable Auto Power Off when you do not intend to operate the instrument.
- Do not route the output from the [AUX OUT] jacks to the [AUX IN] jacks. If you make this connection, the signal input at the [AUX IN] jacks is output from the [AUX OUT] jacks. These connections could result in a feedback loop that will make normal performance impossible, and may even damage the equipment.

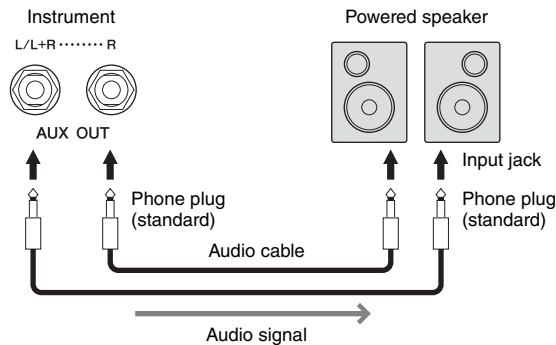

### NOTE

- Use only the [L/L+R] jack for connection with a monaural device.
- Use an appropriate adaptor plug if the input jack of the powered speaker does not match the phone plug of the audio cable.
- Use audio cables and adaptor plugs having no (zero) resistance.

## Connecting an External Monitor ([RGB OUT] terminal)

### CAUTION

Avoid looking at the television or video monitor for prolonged periods of time since doing so could damage your eyesight. Take frequent breaks and focus your eyes on distant objects to avoid eye strain.

By connecting with an external monitor such as a television to the [RGB OUT] terminal of the instrument, the lyrics and text on the instrument's display can be shown on the television or the monitor.

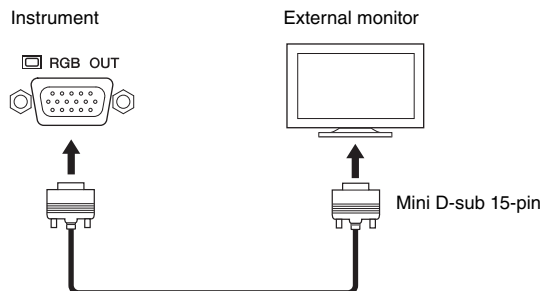

Set the display content that is to be output via [Menu] → [Utility] → [Speaker/Connectivity].

<b>Lyrics/Text</b>	Only the lyrics of the Song or text files (whichever you used last time) are output, regardless of the display that is called up on the instrument.
<b>LCD</b>	The currently selected display is output.

**NOTE**

Transition effects on the instrument's display cannot be output.

## Connecting a Footswitch/Foot Controller ([AUX PEDAL] jack)

The FC4, FC4A or FC5 footswitches and the FC7 foot controller (sold separately) can be connected to [AUX PEDAL] jack. A footswitch can be used for switching functions on and off, while a foot controller controls continuous parameters such as volume.

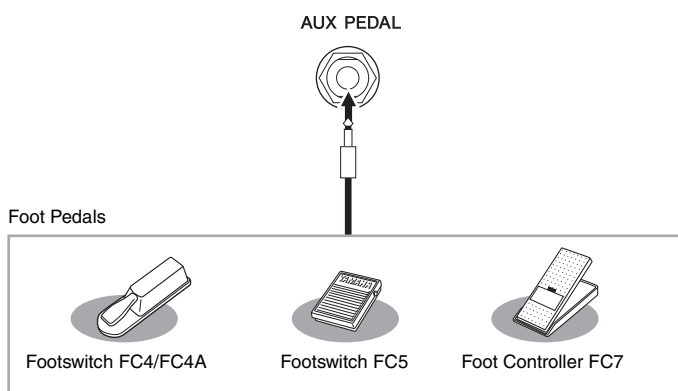

**NOTE**

- Make sure to connect or disconnect the pedal only when the power is off.
- Do not press the footswitch/foot pedal while turning the power on. Doing this changes the recognized polarity of the footswitch, resulting in reversed footswitch operation.

■ **Example 1: Using a foot controller to control the volume of the performance data played on the keyboard.**

Connect an FC7 foot controller to the [AUX PEDAL] jack. With the initial factory settings, no special setup is necessary.

■ **Example 2: Using a footswitch to control Song Start/Stop.**

Connect a footswitch (FC4, FC4A or FC5) to the [AUX PEDAL] jack.

To assign the function to the connected pedal, select “Song Play/Pause” in the operation display: [Menu] → [Assignable] → [Pedal].

## Connecting a Microphone or Guitar ([MIC/LINE IN] jack, [MIC/LINE] switch)

To the [MIC/LINE IN] jack (standard 1/4" phone jack), you can connect a microphone, guitar, or other various equipment. For instructions on connecting a microphone, refer to page 82.

Note that you need to select “MIC” or “LINE IN” depending on the connected equipment. When the output level of the connected equipment (such as a microphone, guitar, bass) is low, set the [MIC/LINE] switch to “MIC.” When the output level of the connected equipment (such as a synthesizer, keyboard, CD player) is high, set the [MIC/LINE] switch to “LINE.”



## Connecting USB Devices ([USB TO DEVICE] terminal)

You can connect a USB flash drive or a USB wireless LAN adaptor to the [USB TO DEVICE] terminal. You can save data you've created on the instrument to the USB flash drive (page 33), or you can connect the instrument to a smart device such as iPad via a USB wireless LAN adaptor (page 98).

### Precautions when using the [USB TO DEVICE] terminal

This instrument features a built-in [USB TO DEVICE] terminal. When connecting a USB device to the terminal, be sure to handle the USB device with care. Follow the important precautions below.

#### NOTE

For more information about the handling of USB devices, refer to the owner's manual of the USB device.

#### ■ Compatible USB devices

- USB flash drive
- USB wireless LAN adaptor (which is included only in some areas)

Other USB devices such as a computer keyboard or mouse cannot be used.

Although USB devices 1.1 to 3.0 can be used on this instrument, the amount of time for saving to or loading from the USB device may differ depending on the type of data or the status of the instrument. The instrument does not necessarily support all commercially available USB devices. Yamaha cannot guarantee operation of USB devices that you purchase. Before purchasing a USB device for use with this instrument, please visit the following web page: <http://download.yamaha.com/>

#### NOTE

The rating of the USB TO DEVICE terminal is a maximum of 5V/500mA. Do not connect USB devices having a rating above this, since this can cause damage to the instrument itself.

#### ■ Connecting a USB device

When connecting a USB device to the [USB TO DEVICE] terminal, make sure that the connector on the device is appropriate and that it is connected in the proper direction.

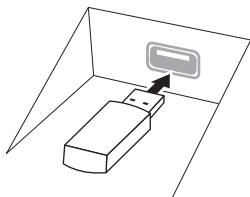

#### NOTICE

- When connecting a USB device to the [USB TO DEVICE] terminal on the top panel, remove it before closing the key cover. If the key cover is closed with the USB device connected, the USB device may be damaged.

- Avoid connecting or disconnecting the USB device while executing playback/recording and file management operations (such as Save, Copy, Delete and Format), or when accessing the USB device. Failure to observe this may result in "freezing" of the operation of the instrument or corruption of the USB device and the data.
- When connecting then disconnecting the USB device (and vice versa), make sure to wait a few seconds between the two operations.

#### NOTE

When connecting a USB cable, make sure that the length is less than 3 meters.

### Using USB flash drives

By connecting the instrument to a USB flash drive, you can save data you've created to the connected device, as well as read data from the connected USB flash drive.

#### ■ Maximum number of USB flash drives

Up to two USB flash drives can be connected to the [USB TO DEVICE] terminal.

#### ■ Formatting USB flash drives

You should format the USB storage device only with this instrument (page 98). A USB storage device formatted on another device may not operate properly.

#### NOTICE

The format operation overwrites any previously existing data. Make sure that the USB flash drive you are formatting does not contain important data. Proceed with caution, especially when connecting multiple USB flash drives.

#### ■ To protect your data (write-protect)

To prevent important data from being inadvertently erased, apply the write-protect provided with each USB flash drive. If you are saving data to the USB flash drive, make sure to disable write-protect.

#### ■ Turning off the instrument

When turning off the instrument, make sure that the instrument is NOT accessing the USB flash drive by playback/recording or file management (such as during Save, Copy, Delete and Format operations). Failure to do so may corrupt the USB flash drive and the data.

## Formatting a USB Flash Drive

When a USB flash drive is connected or media is inserted, a message appears indicating that the connected USB flash drive is not formatted. If so, execute the format operation.

### NOTICE

The Format operation deletes any previously existing data. Make sure that the USB flash drive you are formatting does not contain important data. Proceed with caution, especially when connecting multiple USB flash drives.

- 1 Connect a USB flash drive for formatting to the [USB TO DEVICE] terminal.
- 2 Call up the operation display via [Menu] → [Utility] → [USB Flash Drive].

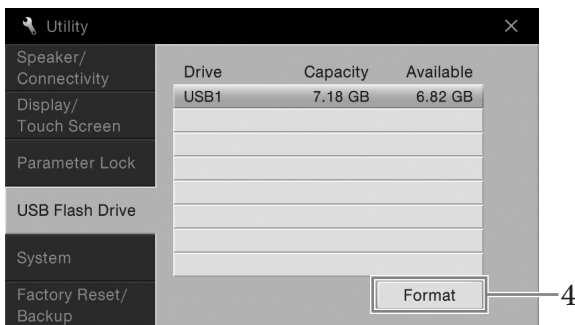

- 3 Touch the name of the USB flash drive to be formatted in the device list.  
The indications USB 1, USB 2, etc. are displayed depending on the number of the connected devices.
- 4 Touch [Format] to execute the Format operation.

## Connecting to an iPhone/iPad ([USB TO DEVICE] terminal, [USB TO HOST] terminal and MIDI terminals)

You can connect a smart device such as an iPhone or iPad to the [USB TO DEVICE] terminal of the instrument via the USB wireless LAN adaptor (if included). The USB wireless LAN adaptor may not be included depending on your locale due to local regulations. If the USB wireless LAN adaptor is not supplied with your instrument, connect the smart device to the [USB TO HOST] terminal via the Yamaha i-UX1 (sold separately) or to the MIDI terminals via the Yamaha i-MX1 (sold separately). By using an application tool on your smart device, you can take advantage of convenient functions and get more enjoyment out of this instrument.

For details on connections, refer to the “iPhone/iPad Connection Manual” on the website (page 9).  
For information about the compatible smart devices and application tools, access the following page:  
<http://www.yamaha.com/kbdapps/>

For inquiries about the included USB wireless LAN adaptor (may not be included, depending on the area), contact your nearest Yamaha representative or the distributor listed at the end of this manual.

Or you can access the following website and contact Yamaha support at your location.  
<http://www.yamaha.com/contact/>

Yamaha does not guarantee or support use of the included USB wireless LAN adaptor (may not be included, depending on the area) with any devices other than this instrument.

### NOTICE

Do not place your iPhone/iPad in an unstable position. Doing so may cause the device to fall and result in damage.

### NOTE

- Before using the [USB TO DEVICE] terminal, be sure to read “Precautions when using the [USB TO DEVICE] terminal” on page 97.
- When you use the instrument along with an application on your iPhone/iPad, we recommend that you first set “Airplane Mode” to “ON” then set “Wi-Fi” to “ON” on your iPhone/iPad in order to avoid noise caused by communication.
- Certain applications may not be supported in your area. Please check with your Yamaha dealer.

## Connecting to a Computer ([USB TO HOST] terminal)

By connecting a computer to the [USB TO HOST] terminal, you can transfer data between the instrument and the computer via MIDI.

For details on using a computer with this instrument, refer to the “Computer-related Operations” on the website (page 9).

### NOTICE

Use an AB type USB cable of less than 3 meters. USB 3.0 cables cannot be used.

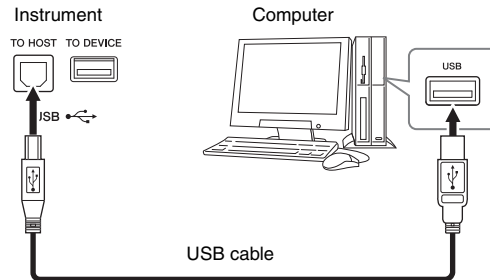

### NOTE

- The instrument will begin transmission a short time after the USB connection is made.
- When using a USB cable to connect the instrument to your computer, make the connection directly without passing through a USB hub.
- For information on setting up your sequence software, refer to the owner's manual of the relevant software.
- You cannot connect a computer to this instrument with a USB wireless LAN adaptor.

## Connecting External MIDI Devices (MIDI terminals)

Use the MIDI [IN]/[OUT]/[THRU] terminals and standard MIDI cables to connect external MIDI devices (keyboard, sequencer, etc.).

**MIDI IN:** Receives MIDI messages from another MIDI device.

**MIDI OUT:** Transmits MIDI messages generated by the instrument to another MIDI device.

**MIDI THRU:** Simply relays the MIDI messages received at MIDI IN.

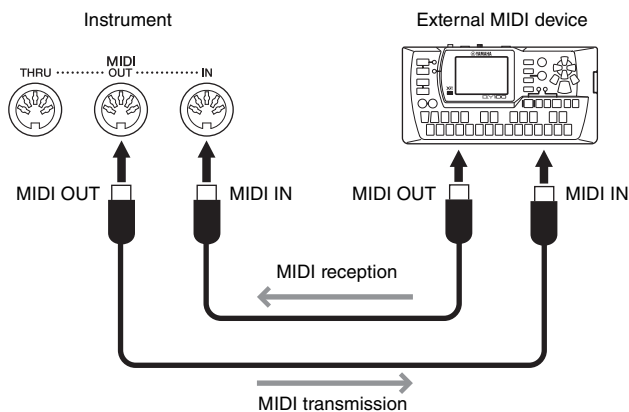

The MIDI settings such as transmit/receive channels on the instrument can be set via [Menu] → [MIDI]. For details, refer to the Reference Manual on the website (page 9).











### NOTE

For a general overview of MIDI and how you can effectively use it, refer to “MIDI Basics” on the website (page 9).

# Menu Display Function List

This section explains simply and very briefly explains what you can do in the displays which are called up by touching each icon on the Menu display. Some functions are described in this Owner's Manual on the pages indicated below. For details about each function, refer to the Reference Manual on the website (page 9).

Menu		Description	Pages
	<b>Tempo</b>	For adjusting the tempo of MIDI Song, Style or Metronome. The same operation as using Tempo [-]/[+] and [TAP TEMPO] buttons can be done on the display.	40
	<b>Transpose</b>	For transposing the pitch of the entire sound in semitones, or just the sound of the keyboard or MIDI Song.	41
	<b>Split Point &amp; Fingering Type</b>	Lets you set the Split Point or change the Chord Fingering type and Chord Detection area.	50, 64
	<b>Chord Tutor</b>	Shows you an example of how to play a chord that corresponds to the specified chord name.	-
	<b>Balance</b>	For adjusting the volume balance among the keyboard parts (Main, Layer, Left), Style, Song, and the sound input via the microphone, [AUX IN] jack, etc.	42
	<b>Filter</b>	For adjusting the Harmonic Content (resonance) and sound brightness.	91
	<b>EQ</b>	For adjusting equalization parameters to correct the tone or timbre of the sound.	
	<b>Effect</b>	For selecting an Effect type and adjusts its depth for each part.	
	<b>Chorus/Reverb</b>	For selecting a Chorus/Reverb type and adjusts its depth for each part.	
	<b>Pan/Volume</b>	For adjusting panning and volume for each part.	
	<b>(Master) Compressor</b>	Lets you turn on/off the Master Compressor, and edit related parameters.	
	<b>(Master) EQ</b>	For editing the Master EQ.	
	<b>Score</b>	For displaying the music notation (score) of the current MIDI Song.	69
	<b>Lyrics</b>	For displaying the lyrics of the current MIDI Song.	70
	<b>Text Viewer</b>	For displaying text files created on your computer.	-
	<b>Keyboard Harmony</b>	For adding the Harmony effect to the right-hand section of the keyboard. Parameters such as Harmony type can be set.	-
	<b>Mic Setting</b>	Makes settings for the microphone sound.	-
	<b>Vocal Harmony</b>	For adding Vocal Harmony effects to your singing. You can edit the Vocal Harmony and save as your original harmony.	83
	<b>Music Finder</b>	For calling up ideal panel settings (as a Record) for your performance. Records can be created or edited.	85
	<b>Registration Sequence</b>	Determines the order for calling up Registration Memory settings when using the pedal.	-
	<b>Registration Freeze</b>	Determines the item(s) to be unchanged even when you call up panel setups from the Registration Memory.	-
	<b>Pedal</b>	Determines the functions assigned to the pedals.	-
	<b>Assignable</b>	Determines the functions assigned to the ASSIGNABLE [1] – [4] buttons.	32
	<b>Voice Edit</b>	Lets you edit the preset Voices to create your own Voices. The display differs depending on whether an Organ Flutes Voice or another kind of Voice is selected.	54
	<b>Style Creator</b>	Lets you create a Style by editing the preset Style, or by recording Style channels one by one.	-

Menu		Description	Pages
 <b>Song Creator</b>		Lets you create a Song by editing an existing recorded Song.	-
 <b>Voice Setting</b>	<b>Tune</b>	For adjusting the pitch for each keyboard part (Main/Layer/Left).	-
	<b>Piano</b>	For editing the parameters of the piano Voices, including the VRM Voices.	
	<b>Voice Set</b>	Determines which settings (effects, etc.) linked to the Voices are not called up when selecting a Voice.	
	<b>Setting</b>	Determines how the Voice Selection display is opened when one of the VOICE category buttons is pressed. Also determines whether to add articulation effects or not when selecting an S.Art2 Voice (CVP-709 only).	
 <b>Style Setting</b>	<b>Setting</b>	For editing parameters for Style playback such as Stop Accompaniment and OTS Link Timing.	-
	<b>Change Behavior</b>	Determines the Style condition (sections, tempo, etc.) when selecting a different Style.	
 <b>Song Setting</b>	<b>Guide</b>	For selecting the type of the Guide function, or changes the guide lamp settings.	-
	<b>Part Ch</b>	Determines which MIDI channel in the Song data is used for the right-hand/left-hand part.	
	<b>Lyrics</b>	Determines the language of the displayed lyrics.	
	<b>Play</b>	For editing parameters for Song playback such as Repeat Playback and the Performance Assistant Technology.	
	<b>Rec</b>	For editing parameters for re-recording of MIDI Songs, or setting the file format for Audio recording.	
 <b>Tuning</b>	<b>Master Tune</b>	For fine-tuning the pitch of the entire instrument in approx. 0.2 Hz steps.	-
	<b>Scale Tune</b>	For selecting the scale type and tuning the pitch of the desired note (key) in cents.	
 <b>Keyboard Setting</b>		Determines the Touch Response of the keyboard, or turns the Left Hold function on/off.	40
 <b>Metronome Setting</b>	<b>Metronome</b>	Determines the metronome volume, sound and time signature.	-
	<b>Tap Tempo</b>	Determines the volume and sound type of the sound caused when the [TAP TEMPO] button is pressed.	
 <b>MIDI Setting</b>	<b>System</b>	For editing the parameters for MIDI system messages.	-
	<b>Transmit</b>	For editing the parameters for MIDI transmission.	
	<b>Receive</b>	For editing the parameters for MIDI reception.	
	<b>On Bass Note</b>	Determines the bass note for Style playback based on the note messages received via MIDI.	
	<b>Chord Detect</b>	Determines the chord type for Style playback based on the note messages received via MIDI.	
 <b>Utility</b>	<b>Speaker/ Connectivity</b>	For making the settings for the instrument's speakers and the external monitor.	95
	<b>Display/ Touch Screen</b>	For editing the parameters for the display settings, such as the theme of the home display, brightness, and touch panel calibration.	-
	<b>Parameter Lock</b>	Determines which parameters (effect, Split Point, etc.) will not be changed when the panel setups are changed via Registration Memory.	-
	<b>USB Flash Drive</b>	Indicates the capacity of the connected USB flash drive or allows you to format it.	98
	<b>System</b>	Indicates the firmware version of this instrument, and lets you make basic settings, such as the language for the display and voice guide.	22
	<b>Factory Reset/ Backup</b>	For initializing the instrument to the factory default, or backing up the data stored in the instrument.	42
 <b>Wireless LAN Settings*</b>		For making settings for connecting the instrument to a smart device such as iPad via a USB wireless LAN adaptor.	-
 <b>Time*</b>		For making settings of the time shown on the display.	-

\* These icons appear only when the USB wireless LAN adaptor (if included) has been connected once.

# CVP-709 (Grand piano type) Assembly

## ⚠ CAUTION

- Assemble the unit on a hard and flat floor with ample space.
- Be careful not to confuse or misplace the parts, and be sure to install all parts in the correct orientation. Please assemble the unit in accordance with the sequence described here.
- Assembly should be carried out by at least two persons.
- Be sure to use only the included screws of the specified sizes. Do not use any other screws. Use of incorrect screws can cause damage or malfunction of the product.
- Be sure to tighten all screws upon completing assembly of each unit.
- To disassemble the unit, reverse the assembly sequence.

Have a Phillips-head (+) screwdriver of the appropriate size ready.

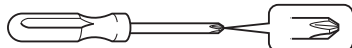

Remove all parts from the package and make sure you have all of the items.

To prevent the key cover from accidentally opening during assembly, press down on the key cover, making sure that the sheets (shown) remain in place.

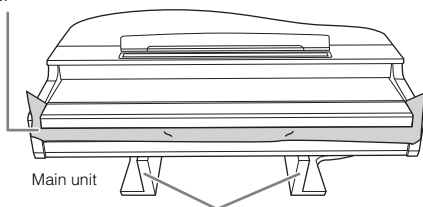

Main unit

To prevent damage to the MIC-HPJ unit located at the bottom of main unit, make sure to place main unit on the styrofoam pads. Also, make sure that the pads do not touch the MIC-HPJ.

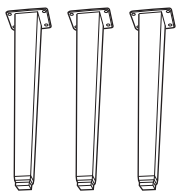

Legs



6 x 40 mm fixing screws x 12



6 x 20 mm fixing screws x 4



Cord holder

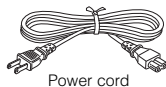

Power cord

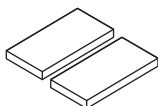

Protective pads x 2

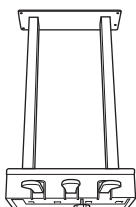

Pedal box

Bundled pedal cord inside. The pedals are covered with covers when shipped from the factory. Remove the cover from the damper pedal for optimum use of the GP Responsive Damper Pedal effect.



Headphone hanger



4 x 10 mm thin screws x 2

## 1 Lean the main unit against the wall as shown.

- 1 Spread a large soft cloth, such as a blanket, as shown to protect the floor and wall surfaces.
- 2 Lean the main unit against the wall with the key cover closed and the keyboard side on the bottom.

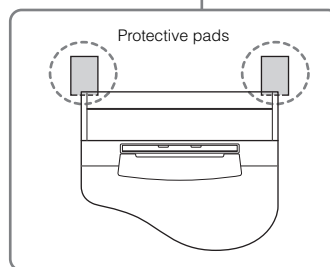
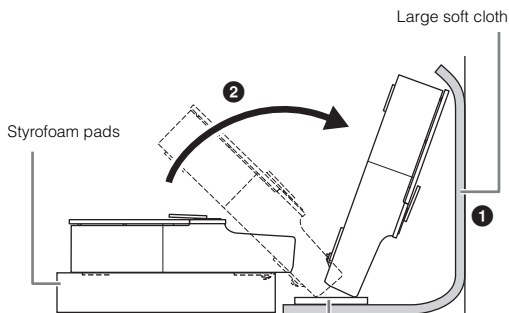

Protective pads

## ⚠ CAUTION

Be careful not to pinch your fingers.

## NOTICE

Do not place the main unit as shown in the illustration here.

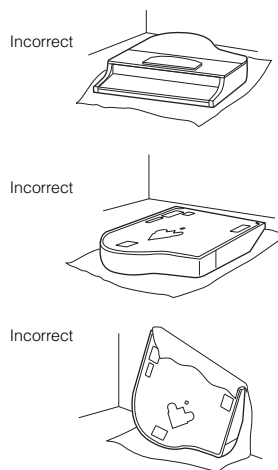

## 2 Attach two front legs and a rear leg.

Refer to the diagram below to verify the orientation of the legs.

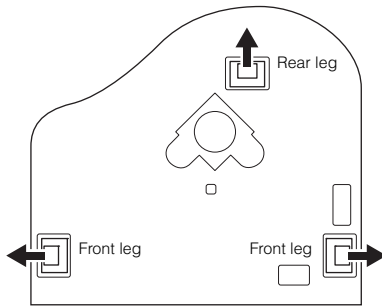

Install and tighten four screws on each leg, starting with one of the front legs.

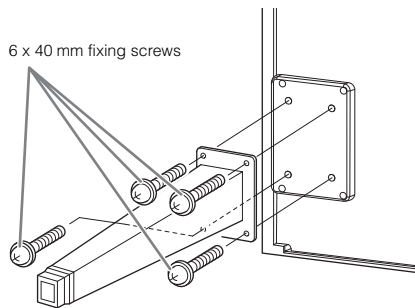

## 3 Install the pedal box.

- 1 Remove the twist tie and tape that affix the pedal cord to the upper portion of the pedal box.

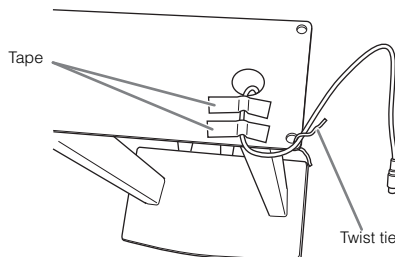

- 2 Align the cord with the groove on the unit, and attach the pedal box using four screws.

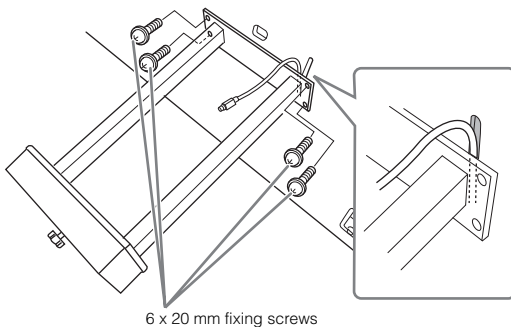

- 3 Insert the pedal cord plug into the pedal connector. Insert the plug into the connector so that the side with the arrow mark is facing forward (keyboard side). If the plug does not fit easily do not try to force it, but check the plug for correct orientation, and then reinsert it into the connector.

Insert the pedal cord securely until the metal part of the cord plug disappears from view. Otherwise, the pedal may not function properly.

- 4 Attach the cord holder on the unit as shown in the illustration below, then use the cord holder to affix the pedal cord.

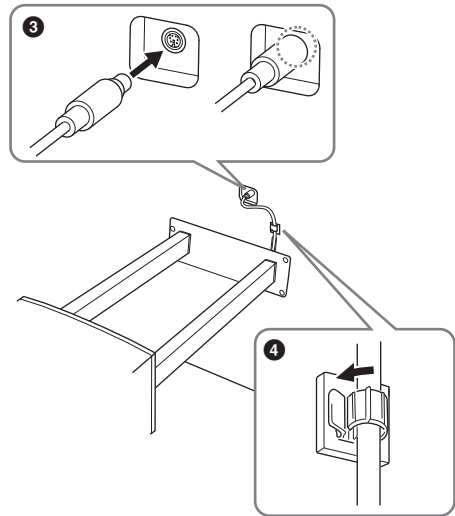

## 4 Raise the unit to the standing position.

Use the front legs as support to raise the unit.

### ⚠ CAUTION

- Be careful not to pinch your fingers.
- When you raise the unit, do not hold the key cover.

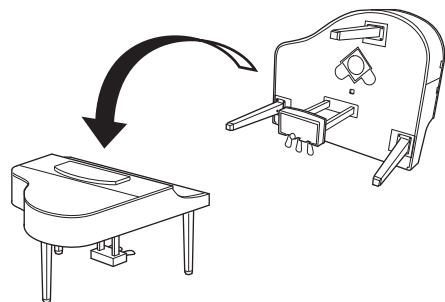

## 5 Plug the power cord into the [AC IN] jack.

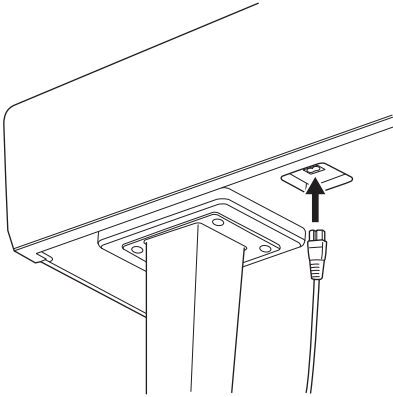

Right leg on the bottom of the main unit, when viewed from front.

## 6 Rotate the adjuster until it comes in firm contact with the floor surface.

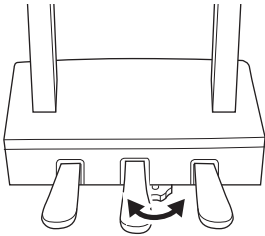

## 7 Attach the headphone hanger.

Attach the headphone hanger using two thin screws (4 x 10 mm) as shown in the illustration.

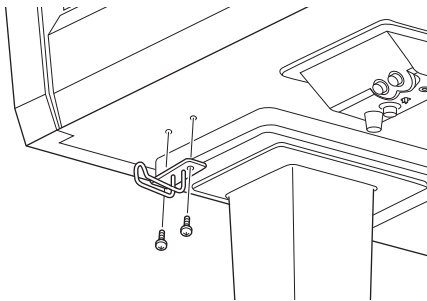

After completing the assembly, please check the following.

- **Are there any parts left over?**  
→ Review the assembly procedure and correct any errors.
- **Is the instrument clear of doors and other movable fixtures?**  
→ Move the instrument to an appropriate location.
- **Does the instrument make a rattling noise when you shake it?**  
→ Tighten all screws.
- **Does the pedal box rattle or give way when you step on the pedals?**  
→ Turn the adjuster so that it is set firmly against the floor.
- **Are the pedal and power cords inserted securely into the sockets?**

### **CAUTION**

When moving the instrument, always hold the bottom of the main unit. Do not hold the key cover or top portion. Improper handling can result in damage to the instrument or personal injury.

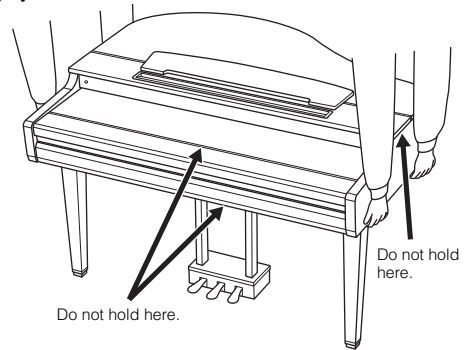

### **Transporting**

If you move to another location, you can transport the instrument along with other belongings. You can move the unit as it is (assembled) or you can disassemble the unit down to the condition it was in when you first took it out of the box. Transport the keyboard horizontally. Do not lean it up against a wall or stand it up on its side. Do not subject the instrument to excessive vibration or shock. When transporting the assembled instrument, make sure all screws are properly tightened and have not been loosened by moving the instrument.

### **CAUTION**

If the unit creaks or is otherwise unsteady when you play on the keyboard, refer to the assembly diagrams and retighten all screws.



# CVP-709 Assembly

## CAUTION

- Assemble the unit on a hard and flat floor with ample space.
- Be careful not to confuse or misplace the parts, and be sure to install all parts in the correct orientation. Please assemble the unit in accordance with the sequence described here.
- Assembly should be carried out by at least two persons.
- Be sure to use only the included screws of the specified sizes. Do not use any other screws. Use of incorrect screws can cause damage or malfunction of the product.
- Be sure to tighten all screws upon completing assembly of each unit.
- To disassemble the unit, reverse the assembly sequence.

Have a Phillips-head (+) screwdriver of the appropriate size ready.

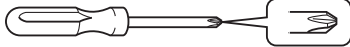

Remove all parts from the package and make sure you have all of the items.

To prevent the key cover from accidentally opening during assembly, press down on the key cover, making sure that the sheets (shown) remain in place.

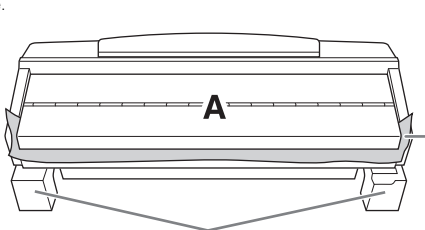

To prevent damage to the speaker box located at the bottom of unit A, make sure to place unit A on the styrofoam pads. Also, make sure that the pads do not touch the speaker box.

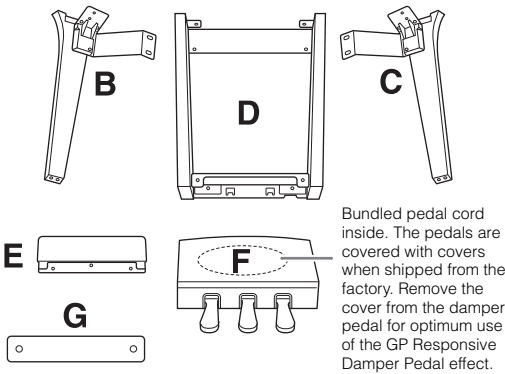

Protective pads x 2

Power cord

Headphone hanger

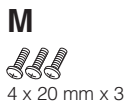

## CVP-709B/CVP-709PE

J, L



N



Q



## CVP-709PWH

J



K



L



(a)



(b)



(c)

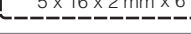

(d)



N



(a)

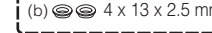

(b)



## 1 Lean unit A against the wall as shown.

- 1 Spread a large soft cloth, such as a blanket, as shown to protect the floor and wall surfaces.
- 2 Lean unit A against the wall with the key cover closed and the keyboard side on the bottom.

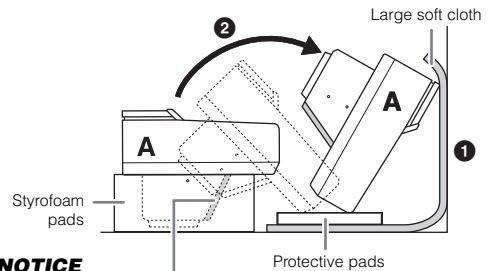

## NOTICE

Do not touch the speaker net. Doing so may damage the speaker inside.

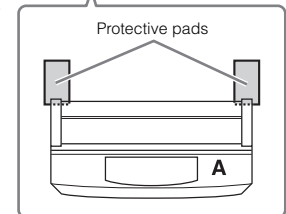

## CAUTION

- Be careful not to pinch your fingers.

## NOTICE

- The top part of the music rest is not fixed. Support the music rest with your hand so that the music rest will not fall.
- Do not place the main unit upside down or with the rear side facing down.

## 2 Attach units B and C to unit A.

- 1 Align units B and A so that the protrusion fits into the hole.

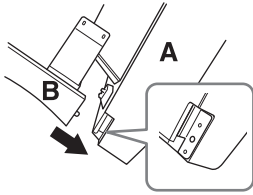

- 2 Fix unit B to the bottom surface of unit A using two screws H.

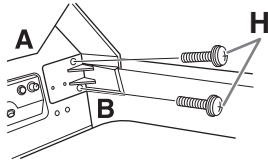

Attach the parts, pressing unit B onto unit A so that the two fit tightly together.

- 3 Fix unit B to the speaker box of unit A using two screws J.

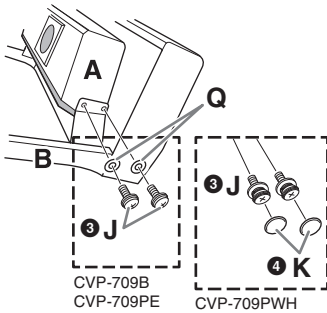

If the screw holes do not align, loosen the other screws and adjust the position of unit B.

- 4 (CVP-709PWH) Attach two caps K.
- 5 Fasten unit C to unit A in the same way.

## 3 Attach unit E to unit D.

Fix unit E to unit D using two screws L.

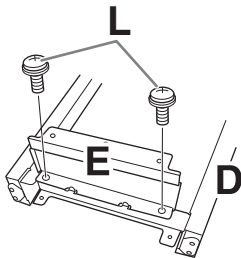

## 4 Attach unit D to unit A.

- 1 Fix unit D to the bottom surface of unit A using two screws L.

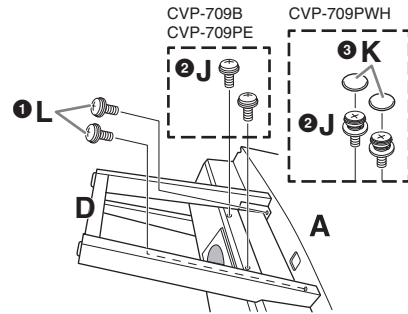

- 2 Fix unit D to the speaker box of unit A using two screws J. If the screw holes do not align, loosen the other screws and adjust the position of unit D.
- 3 (CVP-709PWH) Attach two caps K.

## 5 Raise unit A into the upright position.

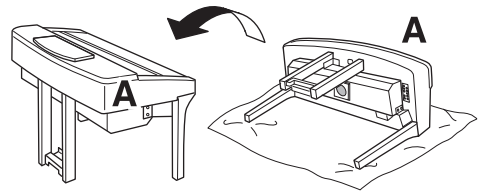

### ⚠ CAUTION

- Be careful not to pinch your fingers.
- When you raise the unit, do not hold the key cover.

## 6 Install unit F.

- 1 Remove the cover from unit D.

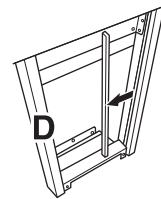

- 2 Untie and straighten out the bundled cord.

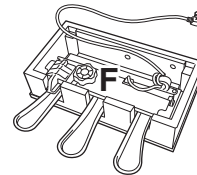

- 3 Pass the pedal cord from under unit D to the backside of the main unit.

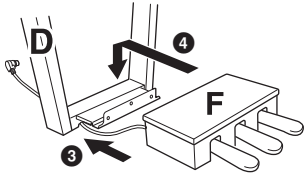

- 4 Place unit F on the bracket of unit D.  
5 Attach unit F to unit D using three screws M.

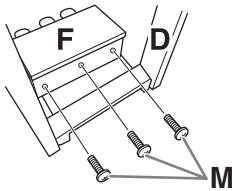

## 7 Connect the pedal cord.

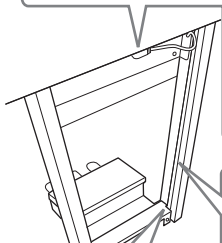
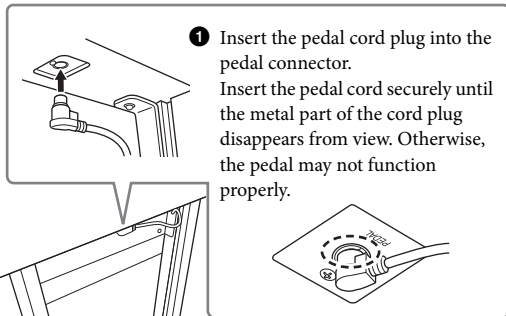

- 2 Pass the pedal cord between units D and E.

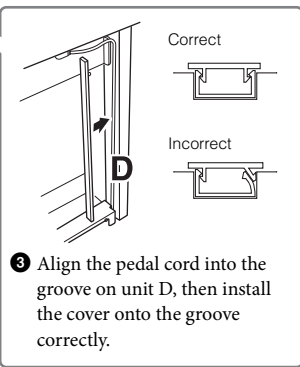

- 4 Attach unit G using two screws N.

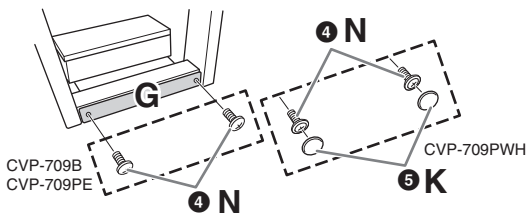

- 5 (CVP-709PWH) Attach two caps K.

- 8 Insert the AC power cord plug into the [AC IN] jack.

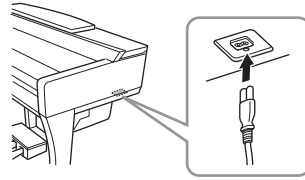

- 9 Rotate the adjuster until it comes in firm contact with the floor surface.

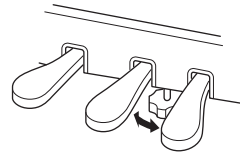

- 10 Attach the headphone hanger.

Attach the headphone hanger using two screws P as shown in the illustration.

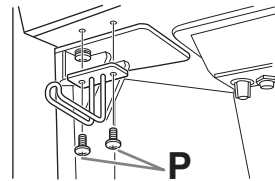

After completing the assembly, please check the following.

- **Are there any parts left over?**  
→ Review the assembly procedure and correct any errors.
- **Is the instrument clear of doors and other movable fixtures?**  
→ Move the instrument to an appropriate location.
- **Does the instrument make a rattling noise when you shake it?**  
→ Tighten all screws.
- **Does the pedal box rattle or give way when you step on the pedals?**  
→ Turn the adjuster so that it is set firmly against the floor.
- **Are the pedal and power cords inserted securely into the sockets?**

**⚠ CAUTION**

When moving the instrument, always hold the bottom of the main unit. Do not hold the key cover or top portion. Improper handling can result in damage to the instrument or personal injury.

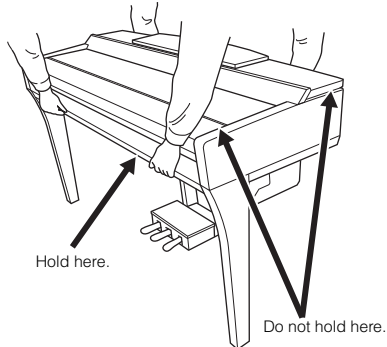

**Transporting**

If you move to another location, you can transport the instrument along with other belongings. You can move the unit as it is (assembled) or you can disassemble the unit down to the condition it was in when you first took it out of the box. Transport the keyboard horizontally. Do not lean it up against a wall or stand it up on its side. Do not subject the instrument to excessive vibration or shock. When transporting the assembled instrument, make sure all screws are properly tightened and have not been loosened by moving the instrument.

**⚠ CAUTION**

If the unit creaks or is otherwise unsteady when you play on the keyboard, refer to the assembly diagrams and retighten all screws.

# CVP-705 Assembly

## ⚠ CAUTION

- Assemble the unit on a hard and flat floor with ample space.
- Be careful not to confuse or misplace the parts, and be sure to install all parts in the correct orientation. Please assemble the unit in accordance with the sequence described here.
- Assembly should be carried out by at least two persons.
- Be sure to use only the included screws of the specified sizes. Do not use any other screws. Use of incorrect screws can cause damage or malfunction of the product.
- Be sure to tighten all screws upon completing assembly of each unit.
- To disassemble the unit, reverse the assembly sequence.

Have a Phillips-head (+) screwdriver of the appropriate size ready.

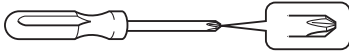

Remove all parts from the package and make sure you have all of the items.

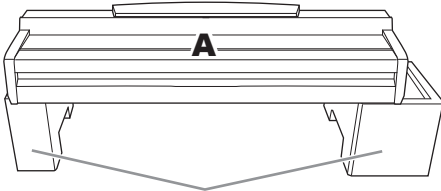

Remove foamed styrol pads from the package, position them on the floor, then place A on top of them. Position the pads so that they will not block the speaker box on the bottom of A.



Bundled pedal cord inside here.

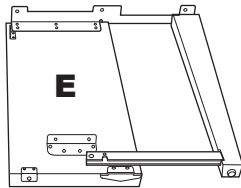
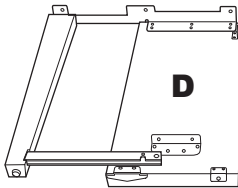

6 x 20 mm x 4

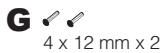

4 x 12 mm x 2



4 x 20 mm x 4



6 x 16 mm x 6



4 x 10 mm x 2

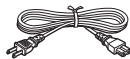

Power cord



Cord holders x 2



Headphone hanger

## 1 Attach C to D and E.

- 1 Untie and straighten out the bundled pedal cord. Do not discard the vinyl tie. You will need the vinyl tie later in step 5.
- 2 Secure D and E to C using four screws F.

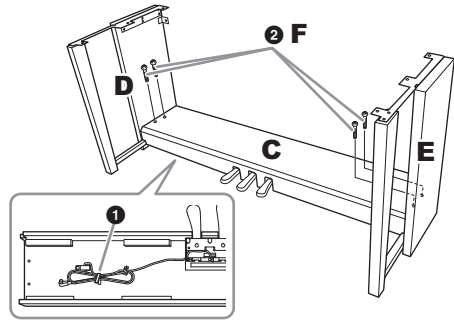

## 2 Attach B.

- 1 Align the holes on the upper side of B with the bracket holes on D and E, then attach the upper corners of B to D and E by finger-tightening two screws G.
- 2 Secure the bottom end of B using four screws H.
- 3 Securely tighten the screws G on the top of B that were attached in step 2-1.

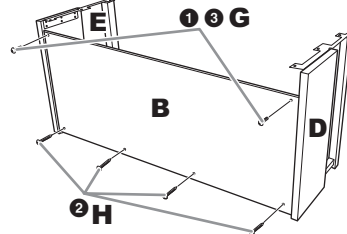

## 3 Mount A.

Be sure to place your hands at least 15 cm from either end of the main unit when positioning it.

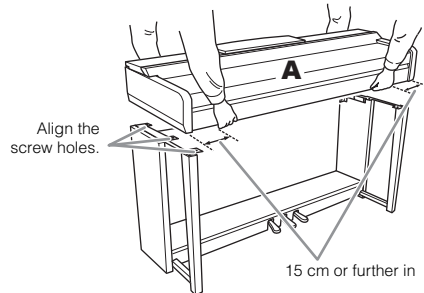

## ⚠ CAUTION

- Be extra careful not to drop the unit or let your fingers be pinched by the main unit.
- Do not hold the main unit in any position other than the position specified here.

## 4 Secure A.

- Adjust the position of A so that the left and right ends of A will project beyond D and E equally as shown in the illustration.
- Attach A using six screws J.

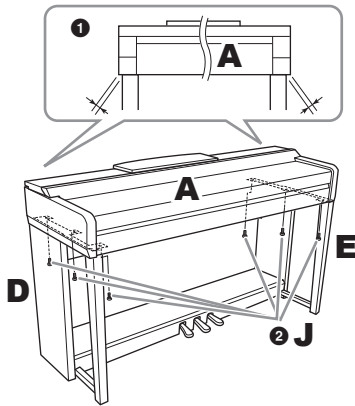

## 5 Connect the pedal cord and power cord.

- Insert the pedal cord plug into the pedal connector. Insert the pedal cord securely until the metal part of the cord plug disappears from view. Otherwise, the pedal may not function properly.
- Attach the cord holders to the rear panel as shown, then clip the cord into the holders.
- Use a vinyl tie to take up any slack in the pedal cord.
- Insert the AC power cord plug into the [AC IN] jack.

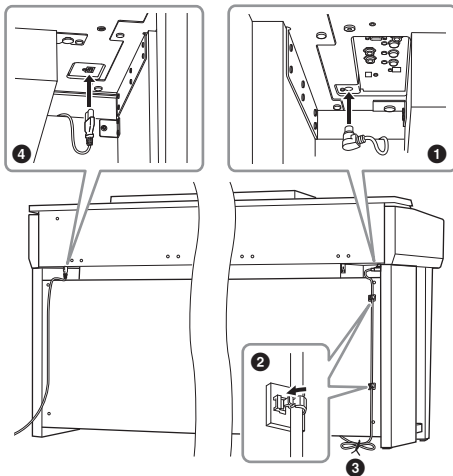
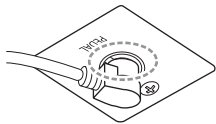

## 6 Rotate the adjuster until it comes in firm contact with the floor surface.

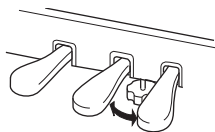

## 7 Attach the headphone hanger.

Attach the headphone hanger using two screws K as shown in the illustration.

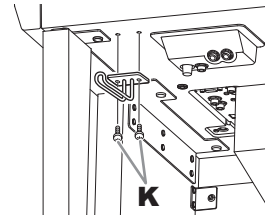

After completing the assembly, please check the following.

- Are there any parts left over?**  
→ Review the assembly procedure and correct any errors.
- Is the instrument clear of doors and other movable fixtures?**  
→ Move the instrument to an appropriate location.
- Does the instrument make a rattling noise when you shake it?**  
→ Tighten all screws.
- Does the pedal box rattle or give way when you step on the pedals?**  
→ Turn the adjuster so that it is set firmly against the floor.
- Are the pedal and power cords inserted securely into the sockets?**

### ⚠ CAUTION

When moving the instrument, always hold the bottom of the main unit. Do not hold the key cover or top portion. Improper handling can result in damage to the instrument or personal injury.

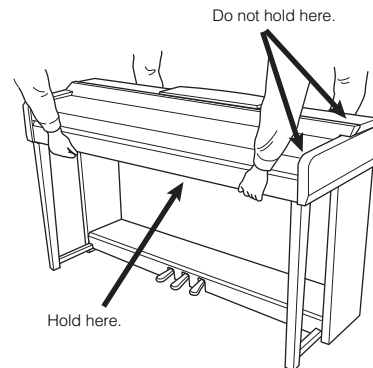

### Transporting

If you move to another location, you can transport the instrument along with other belongings. You can move the unit as it is (assembled) or you can disassemble the unit down to the condition it was in when you first took it out of the box. Transport the keyboard horizontally. Do not lean it up against a wall or stand it up on its side. Do not subject the instrument to excessive vibration or shock. When transporting the assembled instrument, make sure all screws are properly tightened and have not been loosened by moving the instrument.

### ⚠ CAUTION

If the unit creaks or is otherwise unsteady when you play on the keyboard, refer to the assembly diagrams and retighten all screws.

# Troubleshooting

Overall	
<b>A click or pop is heard when the power is turned on or off.</b>	Electrical current is being applied to the instrument. This is normal.
<b>The power is automatically turned off.</b>	This is normal and due to the Auto Power Off function. If necessary, set the parameter of the Auto Power Off function (page 19).
<b>Noise is heard from the instrument's speakers.</b>	Noise may be heard if a mobile phone is used near the instrument or if the phone is ringing. Turn off the mobile phone, or use it further away from the instrument.
<b>In the LCD, there are some specific points that are always lit or unlit.</b>	These are the result of defective pixels and occasionally occur in TFT-LCDs; they do not indicate a problem in operation.
<b>Noise is heard from the instrument's speakers or headphones when using the instrument with the application on iPhone/iPad.</b>	When you use the instrument along with the application on your iPhone/iPad, we recommend that you set "Airplane Mode" to "ON" on your iPhone/iPad in order to avoid noise caused by communication.
<b>Mechanical noise is heard during performance.</b>	The keyboard mechanism of this instrument simulates the keyboard mechanism of an actual piano. Mechanical noise is also heard on a piano.
<b>There is a slight difference in sound quality among different notes played on the keyboard.</b>	This is normal and is a result of the instrument's sampling system.
<b>Some Voices have a looping sound.</b>	
<b>Some noise or vibrato is noticeable at higher pitches, depending upon the Voice.</b>	
<b>The overall volume is too low or no sound is heard.</b>	The master volume may be set too low. Set it to an appropriate level with the [MASTER VOLUME] dial.
	All keyboard parts are set to off. On the Home display, touch [Main]/[Layer]/[Left] to turn on the part (page 48).
	The volume of the individual parts may be set too low. Raise the volume in the Balance display (page 42).
	Make sure the desired channel is set to on (page 93).
	Headphones are connected, disabling the speaker output. Unplug the headphones.
	Make sure that the "Speaker" is set to "On" from [Menu] → [Utility] → [Speaker/Connectivity].
<b>The sound is distorted or noisy.</b>	The volume may be turned up too high. Make sure all relevant volume settings are appropriate.
	This may be caused by certain effects or filter resonance settings. Check the effect or filter settings and change them accordingly in the Mixer display, referring to the Reference Manual on the website (page 9).
<b>Not all simultaneously played notes sound.</b>	You are probably exceeding the maximum polyphony (page 115) of the instrument. When the maximum polyphony is exceeded, the earliest played notes will stop sounding, letting the latest played notes sound.
<b>The keyboard volume is lower than the Song/Style playback volume.</b>	The volume of the keyboard parts may be set too low. Raise the keyboard volume (Main/Layer/Left), or lower the Song/Style volume in the Balance display (page 42).
<b>Some characters of the file/folder name are garbled.</b>	The language settings have been changed. Set the appropriate language for the file/folder name (page 22).

Overall	
<b>An existing file is not shown on the display.</b>	The file extension (.MID, etc.) may have been changed or deleted. Manually rename the file on a computer, adding the appropriate extension.
	Data files with names of more than 50 characters cannot be handled by the instrument. Rename the file, reducing the number of characters to 50 or less.

Voice	
<b>The Voice selected from the Voice Selection display does not sound.</b>	Check whether or not the selected part is turned on (page 48).
<b>A strange “flanging” or “doubling” sound occurs. The sound is slightly different each time the keys are played.</b>	The Main and Layer parts are set to on, and both parts are set to play the same Voice. Turn off the Layer part or change the Voice of one of the parts.
<b>Some Voices will jump an octave in pitch when played in the upper or lower registers.</b>	This is normal. Some Voices have a pitch limit which, when reached, causes this type of pitch shift.

Style	
<b>The Style does not start even when the [START/STOP] button is pressed.</b>	The Rhythm channel of the selected Style may not contain any data. Turn the [ACMP ON/OFF] button on and play in the left-hand section on the keyboard to sound the accompaniment part of the Style.
<b>Only the rhythm channel plays; accompaniment sounds are not heard.</b>	Make sure the Auto Accompaniment function is turned on; press the [ACMP ON/OFF] button.
	Make sure to play keys in the chord section of the keyboard.
<b>Styles in a USB flash drive cannot be selected.</b>	If the size of the Style data is large (about 120 KB or greater), the Style cannot be selected because the data is too large to be read by the instrument.

Song	
<b>Songs cannot be selected.</b>	This may be because the language settings have been changed. Set the appropriate language for the Song file name (page 22).
	If the size of the Song data is large (about 300 KB or greater), the Song cannot be selected because the data is too large to be read by the instrument.
<b>Song playback does not start.</b>	The Song has been stopped at the end of the Song data. Return to the beginning of the Song by pressing the SONG CONTROL [STOP] button.
	In the case of a Song to which write-protect has been applied, there are some restrictions and playback may not be possible. For details, refer to page 37.
<b>(MIDI) Song playback stops before the Song is finished.</b>	The Guide function is turned on. (In this case, playback is “waiting” for the correct key to be played.) Turn off the Guide function (page 70).
<b>(MIDI) The measure number is different from that of the score in the Song Position display, shown by pressing the [REW]/[FF] buttons.</b>	This happens when playing back music data for which a specific, fixed tempo is set.
<b>(MIDI) When playing back a Song, some channels do not play.</b>	Playback of these channels may be set to off. Turn playback on for those channels that are set to off (page 93).



Song	
<b>(MIDI)</b> <b>The Guide lamps do not light during Song playback, even after turning on the Guide function.</b>	Any notes outside of the 88-key range cannot be indicated by the Guide lamps.
<b>(MIDI)</b> <b>The Guide lamps light an octave or two lower/higher than the actual pitch.</b>	The Guide lamps sometimes light an octave or two lower/higher than the actual pitch depending on the selected Voice.
<b>(MIDI)</b> <b>The tempo, beat, measure and music notation is not displayed correctly.</b>	Some Song data for the instrument has been recorded with special “free tempo” settings. For such Song data, the tempo, beat, measure and music notation will not be displayed correctly.
<b>A message indicating the USB flash drive is unavailable appears, and the recording is aborted.</b>	Make sure to use a compatible USB flash drive (page 97).
	Make sure that the USB flash drive has enough memory (page 98).
	If you are using a USB flash drive to which data has already been recorded, check first that no important data remains on the device, then format it (page 98) and try recording again.
<b>The Song playback volume differs depending on the selected Song.</b>	The volume of MIDI Songs and Audio Songs are set independently. Adjust the volume in the Balance display (page 42) after selecting a Voice.

Microphone	
<b>The microphone input signal cannot be recorded.</b>	The microphone input signal cannot be recorded by MIDI recording. Record by using Audio recording (page 75).
<b>Harmony can be heard in addition to the microphone sound.</b>	Vocal Harmony is set to “On.” Turn Vocal Harmony off (page 83).
<b>The Vocal Harmony effect sounds distorted or out-of-tune.</b>	Your vocal microphone may be picking up extraneous sounds, such as the Style sound from the instrument. In particular, bass sounds can cause mistracking of Vocal Harmony. To remedy this: <ul style="list-style-type: none"> <li>• Sing as closely to the microphone as possible.</li> <li>• Use a unidirectional microphone.</li> <li>• Turn down the Master volume, or adjust the volume balance on the Balance display (page 42).</li> </ul>
<b>The Vocal Harmony effect is not applied even when it is turned on.</b>	In the Chordal mode, Vocal Harmony is added only when chords are detected. Try one of the following: <ul style="list-style-type: none"> <li>• Turn on the [ACMP ON/OFF] button and play chords in the chord section during Style playback.</li> <li>• Turn on the Left part and play chords in the left hand section.</li> <li>• Play back a Song which contains chords.</li> <li>• Set the “Stop ACMP” parameter to something other than “Disabled” via [Menu] → [StyleSetting] → [Setting]. For details, refer to the Reference Manual on the website (page 9).</li> </ul>

Mixer	
<b>The sound seems strange or different than expected when changing a rhythm Voice (drum kit, etc.) of the Style or Song from the Mixer.</b>	When changing the rhythm/percussion Voices (drum kits, etc.) of the Style and Song from the VOICE parameter, the detailed settings related to the drum voice are reset, and in some cases you may be unable to restore the original sound. You can restore the original sound by selecting the same Song or Style again.

Pedal/AUX Pedal	
<b>The damper, sostenuto and soft functions do not work for the relevant pedals.</b>	The pedal cord plug is not connected. Securely insert the pedal cord plug into the proper jack (pages 103, 107, 110).
	Make sure that each pedal is properly assigned to "Sustain," "Sostenuto" and "Soft" (page 38).
<b>The on/off setting of the footswitch connected to the [AUX PEDAL] jack is reversed.</b>	Turn the instrument's power off, then turn it on again without pressing the footswitch, or change the Polarity parameter from [Menu] → [Assignable] → [Pedal].
<b>The damper pedal does not function properly.</b>	The power of the instrument may have been turned on while the damper pedal was pressed. Press and release the damper pedal to restore proper operation.

AUX IN jack	
<b>Sound input to the [AUX IN] jack is interrupted.</b>	The output volume of the external device connected to this instrument is too low. Increase the output volume of the external device. The volume level reproduced via this instrument's speakers can be adjusted by using the [MASTER VOLUME] control. The Noise Gate function may be cutting the soft sounds. If this happens, turn off the "AUX In Noise Gate" parameter (page 95).

# Specifications

			CVP-709GP (Grand Piano type)	CVP-709	CVP-705	
Product Name			Digital Piano			
Size/Weight	Width [For models with polished finish]		[1,435 mm (56-1/2")]	1,426 mm (56-1/8") [1,429 mm (56-1/4")]	1,420 mm (55-15/16") [1,422 mm (56")]	
	Height [For models with polished finish]	With Music Rest closed	[913 mm (35-15/16")]	868 mm (34-3/16") [872 mm (34-5/16")]		
		With Music Rest	[1,077 mm (42-3/8")]	1,025 mm (40-3/8") [1,027 mm (40-7/16")]		
	Depth [For models with polished finish]	With Music Rest closed	[1,150 mm (45-1/4")]	612 mm (24-1/8") [612 mm (24-1/8")]	606 mm (23-7/8") [607 mm (23-7/8")]	
		With Music Rest		611 mm (24-1/16") [611 mm (24-1/16")]	581 mm (22-7/8") [581 mm (22-7/8")]	
	Weight [For models with polished finish]		[110 kg (242 lbs., 8 oz)]	79.0 kg (174 lbs., 3 oz) [82.0 kg (180 lbs., 12 oz)]	77.4 kg (170 lbs., 10 oz) [80.1 kg (176 lbs., 9 oz)]	
Control Interface	Keyboard	Number of Keys	88			
		Type	NWX with synthetic ivory keytops, escapement			
		88-key Linear Graded Hammers	Yes	-		
		Counter Weight	Yes	-		
		Touch Response	Hard2/Hard1/Medium/Soft1/Soft2			
	Pedal	Number of Pedals	3			
		Half Pedal	Yes			
		GP Response Damper Pedal	Yes	-		
		Functions	Sustain, Sostenuto, Soft, Glide, Song Play/Pause, Style Start/Stop, Volume, etc.			
	Display	Type	TFT Color LCD			
		Size	800 x 480 dots 8.5 inch		800 x 480 dots 7 inch	
		Touch Screen	Yes			
		Brightness	Yes			
		Score Display Function	Yes			
		Lyrics Display Function	Yes			
		Text Viewer Function	Yes			
		Language	English, Japanese, German, French, Spanish, Italian			
	Panel	Language	English only			
	Cabinet	Key Cover Style		Folding		
		Music Rest		Yes		
Music Clips		Yes				
Voices	Tone Generation	Piano Sound	Yamaha CFX, Bösendorfer Imperial			
	Piano Effect	VRM	Yes			
		Key-off Samples	Yes			
		Smooth Release	Yes			
	Polyphony	Number of Polyphony (max.)	256			

			CVP-709GP (Grand Piano type)	CVP-709	CVP-705
Voices	Preset	Number of Voices	1,270 Voices + 37 Drum/SFX Kits + 480 XG Voices		984 Voices + 33 Drum/SFX Kits + 480 XG Voices
		Featured Voices	13 VRM Voices, 22 Super Articulation2 Voices, 225 Super Articulation Voices, 54 Mega Voices, 67 Natural! Voices, 31 Sweet! Voices, 87 Cool! Voices, 131 Live! Voices, 30 Organ Flutes! Voices		13 VRM Voices, 114 Super Articulation Voices, 30 Mega Voices, 46 Natural! Voices, 31 Sweet! Voices, 74 Cool! Voices, 86 Live! Voices, 30 Organ Flutes! Voices
	Custom	Voice Edit	Yes		
	Compatibility		XG, GS (for Song playback), GM, GM2		
Effects	Types	Reverb	58 Preset + 3 User		
		Chorus	106 Preset + 3 User		
		Insertion Effect	322 Preset + 10 User		
		Variation Effect	322 Preset + 3 User		
		Master Compressor	5 Preset + 5 User		
		Master EQ	5 Preset + 2 User		
		Part EQ	27 Parts		
		Vocal Harmony	VH2: 44 Preset + 60 User		
		Intelligent Acoustic Control (IAC)	Yes		
	Stereophonic Optimizer	Yes			
Functions	Dual (Layer)	Yes			
	Split	Yes			
Styles	Preset	Number of Styles	600		470
		Featured Styles	30 Audio Styles, 473 Pro Styles, 52 Session Styles, 9 Free Play Styles, 36 Pianist Styles		396 Pro Styles, 34 Session Styles, 4 Free Play Styles, 36 Pianist Styles
	File Format		Style File Format GE (Guitar Edition)		
	Fingering		Single Finger, Fingered, Fingered On Bass, Multi Finger, AI Fingered, Full Keyboard, AI Full Keyboard		
	Style Control		INTRO x 3, MAIN VARIATION x 4, FILL x 4, BREAK, ENDING x 3		
	Custom	Style Creator	Yes		
	Other Features	Music Finder (max.)	2,500 Records		
		One Touch Setting (OTS)	4 for each Style		
Style Recommender		Yes			
Recording/ Playback (MIDI)	Preset	Number of Preset Songs	124		
		Recording	Number of Tracks	16	
	Data Capacity		approx. 300 KB/Song		
	Compatible Data Format	Recording	SMF (Format 0)		
Playback		SMF (Format 0 & 1), XF			
Songs (Audio)	Recording Time (max.)		80 minutes/Song		
	Data Format (Recording/Playback)		.wav, .mp3 (MPEG-1 Audio Layer-3)		
	Time Stretch		Yes		
	Pitch Shift		Yes		
	Vocal Cancel		Yes		

		CVP-709GP (Grand Piano type)	CVP-709	CVP-705	
Functions	Registration Memory	Number of Buttons	8		
		Control	Registration Sequence, Freeze		
	Lesson/Guide		Follow Lights, Any Key, Karao-Key, Your Tempo		
		Guide Lamp	Yes		
		Performance Assistant Technology (PAT)	Yes		
	Demo		Yes		
	Overall Controls	Metronome	Yes		
		Tempo	5 – 500, Tap Tempo		
		Transpose	-12 – 0 – +12		
		Tuning	414.8 – 440 – 466.8 Hz		
		Scale Type	9 Types		
	Miscellaneous	Piano Room	Yes		
Storage and Connectivity	Storage	Internal Memory	approx. 6.3 MB	approx. 2.4 MB	
		External Memory	USB Flash Drive		
	Connectivity	Headphones	Standard stereo phone jack (x 2)		
		Microphone	Input Volume, Mic/Line In		
		MIDI	IN, OUT, THRU		
		AUX IN	Stereo mini jack		
		AUX OUT	L/L+R, R		
		AUX PEDAL	Yes		
		RGB OUT	Yes		
		USB TO DEVICE	Yes (x 2)		
USB TO HOST	Yes				
Sound system	Amplifiers	(30W + 30W + 20W) x 2 + 40W		(50W + 20W) x 2	
	Speakers	(16cm + 5cm + 3cm (dome)) x 2 + 20cm		(16cm + 5cm) x 2	
	Acoustic Optimizer	Yes			
	Spruce Cone Speaker	Yes	–		
	Twisted Flare Port	Yes	–		
Power Supply	Auto Power Off	Yes			
Included Accessories		Owner's Manual (this book), Data List, Warranty*, "50 Greats for the Piano" music book, Online Member Product Registration, AC power cord, Bench*, USB wireless LAN adaptor*, Owner's Manual of USB wireless LAN adaptor* * May not be included depending on your area. Check with your Yamaha dealer.			
Separately Sold Accessories (May not be available depending on your area.)		Headphones HPE-160, Footswitches FC4/FC4A/FC5, Foot controller FC7, USB wireless LAN adaptor UD-WL01, USB MIDI Interface for iPhone/iPod touch/iPad i-UX1, MIDI Interface for iPhone/iPod touch/iPad i-MX1			

The contents of this manual apply to the latest specifications as of the printing date. Since Yamaha makes continuous improvements to the product, this manual may not apply to the specifications of your particular product. To obtain the latest manual, access the Yamaha website then download the manual file. Since specifications, equipment or separately sold accessories may not be the same in every locale, please check with your Yamaha dealer.

# Index

## A

A-B Repeat .....	72
Accessories .....	9
ACMP ON/OFF button .....	58
AI Fingered .....	65
AI Full Keyboard .....	65
Assembly .....	102, 105, 109
ASSIGNABLE buttons .....	32
Audio connection .....	94
Audio conversion .....	81
Audio recording .....	75
Audio Song .....	66
Audio Style .....	57
Auto Accompaniment .....	55
Auto Fill .....	59
Auto Power Off .....	19

## B

Backup .....	43
Balance .....	42
Bank .....	89
Break .....	59
Brightness .....	23

## C

Channel .....	78, 93
Character entry .....	37
Chord .....	65
Chord section .....	56
Chordal .....	83
Chorus .....	92
Compressor .....	92
Computer .....	99
Connection .....	94
Copy .....	35
Copyright .....	22

## D

Damper Pedal .....	38
Data dial .....	30
Delete .....	35
Demo .....	13
Display .....	26

## E

Effect .....	92
Ending section .....	58
EQ .....	92

## F

Factory Reset .....	42
Fast Forward .....	68
Favorite .....	36

File .....	33
File Selection display .....	27
Filter .....	92
Fingered .....	64
Fingered On Bass .....	64
Fingering type .....	64
Fixed Velocity .....	41
Folder .....	34
Foot Controller .....	96
Footswitch .....	96
Force-quit .....	19
Format .....	8, 98
Full Keyboard .....	64

## G

GP Responsive Damper Pedal .....	39
Guide .....	70

## H

Half-pedal .....	38
Headphones .....	21
Home display .....	26
Home Theme .....	23

## I

IAC .....	20
Initialize (Factory Reset) .....	42
Intro section .....	58
iPad .....	98
iPhone .....	98

## K

Karaoke .....	84
Key cover .....	16

## L

Language .....	22
Layer part .....	48
Left Hold .....	51
Left part .....	48
Left Split Point .....	50
Lid .....	17
Lyrics .....	70

## M

Main part .....	48
Main section .....	59
Master Compressor .....	92
Master volume .....	20
Menu area .....	27
Menu display .....	28, 100
Metronome .....	39
Microphone .....	82

MIDI connection .....	99
MIDI recording .....	75
MIDI Song .....	66
Mixer .....	91
Monitor .....	95
Move .....	35
MP3 .....	75
Multi channel recording .....	78
Multi Finger .....	64
Music Finder .....	85
Music notation .....	69
Music rest .....	16
<b>N</b>	
Noise Gate .....	95
<b>O</b>	
One Touch Setting .....	60
Organ Flutes Voice .....	54
OTS .....	60
OTS Link .....	60
Owner Name .....	22
<b>P</b>	
Pan .....	92
Pause .....	68
Pedal .....	38, 96
Piano Lock .....	51
Piano Reset .....	51
Piano Room .....	44
Pitch .....	42
Pitch Shift .....	73
Playback (Song) .....	66
Playback (Style) .....	58
Power .....	18
Power cord .....	18
<b>R</b>	
Record .....	85, 87
Recording (Piano Room) .....	47
Recording (Song) .....	75
Reference Manual .....	9
Registration area .....	26
Registration Memory .....	88
Rename .....	34
Repeat .....	72
Restore .....	42
Reverb .....	92
Rewind .....	68
Rotary Speaker .....	54
<b>S</b>	
S.Art Voice .....	53
S.Art2 Voice .....	53
Save .....	33
Score .....	69
Shortcut .....	31
Single Finger .....	64
Smart device .....	98
Soft Pedal .....	39
Song .....	66
Song area .....	26
Sostenuto Pedal .....	39
Speed (Tempo) .....	74
Split Point .....	50
Stereophonic Optimizer .....	21
Style .....	55
Style area .....	26
Style Recommender .....	62
Style Split Point .....	50
Super Articulation Voice .....	53
Synchro Start (MIDI Song) .....	69
Synchro Start (Style) .....	58
Synchro Stop .....	58
<b>T</b>	
Talk .....	84
Tempo .....	40
Text .....	70
Time Stamp .....	23
Time Stretch .....	74
Touch Curve .....	41
Touch Response .....	40
Touch screen .....	29
Touch Sensitivity .....	40
Transpose .....	41
Troubleshooting .....	111
Tuning .....	42
<b>U</b>	
USB flash drive .....	97
USB wireless LAN adaptor .....	98
User memory .....	27
User tab .....	27
<b>V</b>	
Version .....	22
Vocal Cancel .....	74
Vocal Harmony .....	83
Vocoder .....	83
Vocoder-Mono .....	83
Voice .....	48
Voice area .....	26
Volume .....	20
Volume (Song) .....	42
Volume (Style) .....	42
Volume Balance .....	42
VRM Voice .....	52
<b>W</b>	
WAV .....	75



### Information for Users on Collection and Disposal of Old Equipment

This symbol on the products, packaging, and/or accompanying documents means that used electrical and electronic products should not be mixed with general household waste.

For proper treatment, recovery and recycling of old products, please take them to applicable collection points, in accordance with your national legislation and the Directives 2002/96/EC.

By disposing of these products correctly, you will help to save valuable resources and prevent any potential negative effects on human health and the environment which could otherwise arise from inappropriate waste handling.

For more information about collection and recycling of old products, please contact your local municipality, your waste disposal service or the point of sale where you purchased the items.

#### [For business users in the European Union]

If you wish to discard electrical and electronic equipment, please contact your dealer or supplier for further information.

#### [Information on Disposal in other Countries outside the European Union]

This symbol is only valid in the European Union. If you wish to discard these items, please contact your local authorities or dealer and ask for the correct method of disposal.

(weee\_eu\_en\_01)



### Information concernant la Collecte et le Traitement des déchets d'équipements électriques et électroniques.

Le symbole sur les produits, l'emballage et/ou les documents joints signifie que les produits électriques ou électroniques usagés ne doivent pas être mélangés avec les déchets domestiques habituels.

Pour un traitement, une récupération et un recyclage appropriés des déchets d'équipements électriques et électroniques, veuillez les déposer aux points de collecte prévus à cet effet, conformément à la réglementation nationale et aux Directives 2002/96/EC.

En vous débarrassant correctement des déchets d'équipements électriques et électroniques, vous contribuerez à la sauvegarde de précieuses ressources et à la prévention de potentiels effets négatifs sur la santé humaine qui pourraient advenir lors d'un traitement inapproprié des déchets.

Pour plus d'informations à propos de la collecte et du recyclage des déchets d'équipements électriques et électroniques, veuillez contacter votre municipalité, votre service de traitement des déchets ou le point de vente où vous avez acheté les produits.

#### [Pour les professionnels dans l'Union Européenne]

Si vous souhaitez vous débarrasser des déchets d'équipements électriques et électroniques veuillez contacter votre vendeur ou fournisseur pour plus d'informations.

#### [Information sur le traitement dans d'autres pays en dehors de l'Union Européenne]

Ce symbole est seulement valable dans l'Union Européenne. Si vous souhaitez vous débarrasser de déchets d'équipements électriques et électroniques, veuillez contacter les autorités locales ou votre fournisseur et demander la méthode de traitement appropriée.

(weee\_eu\_fr\_01)



### Información para Usuarios sobre Recolección y Disposición de Equipamiento Viejo

Este símbolo en los productos, embalaje, y/o documentación que se acompañe significa que los productos electrónicos y eléctricos usados no deben ser mezclados con desechos hogareños corrientes. Para el tratamiento, recuperación y reciclado apropiado de los productos viejos, por favor llévelos a puntos de recolección aplicables, de acuerdo a su legislación nacional y las directivas 2002/96/EC.

Al disponer de estos productos correctamente, ayudará a ahorrar recursos valiosos y a prevenir cualquier potencial efecto negativo sobre la salud humana y el medio ambiente, el cual podría surgir de un inapropiado manejo de los desechos.

Para mayor información sobre recolección y reciclado de productos viejos, por favor contacte a su municipio local, su servicio de gestión de residuos o el punto de venta en el cual usted adquirió los artículos.

#### [Para usuarios de negocios en la Unión Europea]

Si usted desea deshacerse de equipamiento eléctrico y electrónico, por favor contacte a su vendedor o proveedor para mayor información.

#### [Información sobre la Disposición en otros países fuera de la Unión Europea]

Este símbolo sólo es válido en la Unión Europea. Si desea deshacerse de estos artículos, por favor contacte a sus autoridades locales y pregunte por el método correcto de disposición.

(weee\_eu\_es\_01)



The followings are the titles, credits and copyright notices for fifty seven (57) of the songs pre-installed in this instrument (CVP-709/CVP-705):

#### **Alfie**

Theme from the Paramount Picture ALFIE  
Words by Hal David  
Music by Burt Bacharach  
Copyright © 1966 (Renewed 1994) by Famous Music Corporation  
International Copyright Secured All Rights Reserved

#### **All Shook Up**

Words and Music by Otis Blackwell and Elvis Presley  
Copyright © 1957 by Shalimar Music Corporation  
Copyright Renewed and Assigned to Elvis Presley Music  
All Rights Administered by Cherry River Music Co. and Chrysalis Songs  
International Copyright Secured All Rights Reserved

#### **Beauty And The Beast**

from Walt Disney's BEAUTY AND THE BEAST  
Lyrics by Howard Ashman  
Music by Alan Menken  
© 1991 Walt Disney Music Company and Wonderland Music Company, Inc.  
All Rights Reserved Used by Permission

#### **Bésame Mucho (Kiss Me Much)**

Music and Spanish Words by Consuelo Velazquez  
English Words by Sunny Skylar  
Copyright © 1941, 1943 by Promotora Hispano Americana de Musica, S.A.  
Copyrights Renewed  
All Rights Administered by Peer International Corporation  
International Copyright Secured All Rights Reserved

#### **Blue Hawaii**

from the Paramount Picture WAIKIKI WEDDING  
Words and Music by Leo Robin and Ralph Rainger  
Copyright © 1936, 1937 (Renewed 1963, 1964) by Famous Music Corporation  
International Copyright Secured All Rights Reserved

#### **Blue Moon**

Words by Lorenz Hart  
Music by Richard Rodgers  
© 1934 (Renewed 1962) METRO-GOLDWYN-MAYER INC.  
All Rights Controlled by EMI ROBBINS CATALOG INC. (Publishing) and WARNER BROS. PUBLICATIONS U.S. INC. (Print)  
All Rights Reserved Used by Permission

#### **Brazil**

Words and Music by Ray Barroso  
English lyrics by S. K. Russell  
Copyright © 1941 by Peer International Corporation  
Copyright Renewed  
International Copyright Secured All Rights Reserved

#### **California Girls**

Words and Music by Brian Wilson and Mike Love  
Copyright © 1965 IRVING MUSIC, INC.  
Copyright Renewed  
All Rights Reserved Used by Permission

#### **Can You Feel The Love Tonight**

from Walt Disney Pictures' THE LION KING  
Music by Elton John  
Lyrics by Tim Rice  
© 1994 Wonderland Music Company, Inc.  
All Rights Reserved Used by Permission

#### **Can't Help Falling In Love**

from the Paramount Picture BLUE HAWAII  
Words and Music by George David Weiss, Hugo Peretti and Luigi Creatore  
Copyright © 1961 by Gladys Music, Inc.  
Copyright Renewed and Assigned to Gladys Music  
All Rights Administered by Cherry Lane Music Publishing Company, Inc. and Chrysalis Music  
International Copyright Secured All Rights Reserved

#### **Chim Chim Cher-ee**

from Walt Disney's MARY POPPINS  
Words and Music by Richard M. Sherman and Robert B. Sherman  
© 1963 Wonderland Music Company, Inc.  
Copyright Renewed  
All Rights Reserved Used by Permission

#### **Do-Re-Mi**

from THE SOUND OF MUSIC  
Lyrics by Oscar Hammerstein II  
Music by Richard Rodgers  
Copyright © 1959 by Richard Rodgers and Oscar Hammerstein II  
Copyright Renewed  
WILLIAMSON MUSIC owner of publication and allied rights throughout the world  
International Copyright Secured All Rights Reserved

#### **Don't Be Cruel (To A Heart That's True)**

Words and Music by Otis Blackwell and Elvis Presley  
Copyright © 1956 by Unart Music Corporation and Elvis Presley Music, Inc.  
Copyright Renewed and Assigned to Elvis Presley Music  
All Rights Administered by Cherry River Music Co. and Chrysalis Songs  
International Copyright Secured All Rights Reserved

#### **Edelweiss**

from THE SOUND OF MUSIC  
Lyrics by Oscar Hammerstein II  
Music by Richard Rodgers  
Copyright © 1959 by Richard Rodgers and Oscar Hammerstein II  
Copyright Renewed  
WILLIAMSON MUSIC owner of publication and allied rights throughout the world  
International Copyright Secured All Rights Reserved

#### **Fly Me To The Moon (In Other Words)**

featured in the Motion Picture ONCE AROUND  
Words and Music by Bart Howard  
TRO - © Copyright 1954 (Renewed) Hampshire House Publishing Corp., New York, NY  
International Copyright Secured  
All Rights Reserved Including Public Performance For Profit  
Used by Permission

#### **Hey Jude**

Words and Music by John Lennon and Paul McCartney  
Copyright © 1968 Sony/ATV Songs LLC  
Copyright Renewed  
All Rights Administered by Sony/ATV Music Publishing, 8 Music Square West, Nashville, TN 37203  
International Copyright Secured All Rights Reserved

#### **Hound Dog**

Words and Music by Jerry Leiber and Mike Stoller  
Copyright © 1956 by Elvis Presley Music, Inc. and Lion Publishing Co., Inc.  
Copyright Renewed, Assigned to Gladys Music and Universal - MCA Music Publishing, A Division of Universal Studios, Inc.  
All Rights Administered by Cherry Lane Music Publishing Company, Inc. and Chrysalis Music  
International Copyright Secured All Rights Reserved

#### **I Just Called To Say I Love You**

Words and Music by Stevie Wonder  
© 1984 JOBETE MUSIC CO., INC. and BLACK BULL MUSIC  
c/o EMI APRIL MUSIC INC.  
All Rights Reserved International Copyright Secured Used by Permission

#### **I Left My Heart In San Francisco**

Words by Douglass Cross  
Music by George Cory  
© 1954 (Renewed 1982) COLGEMS-EMI MUSIC INC.  
All Rights Reserved International Copyright Secured Used by Permission

**In The Mood**

By Joe Garland  
Copyright © 1939, 1960 Shapiro, Bernstein & Co., Inc., New York  
Copyright Renewed  
International Copyright Secured All Rights Reserved  
Used by Permission

**Isn't She Lovely**

Words and Music by Stevie Wonder  
© 1976 JOBETE MUSIC CO., INC. and BLACK BULL MUSIC  
c/o EMI APRIL MUSIC INC.  
All Rights Reserved International Copyright Secured Used by  
Permission

**Let It Be**

Words and Music by John Lennon and Paul McCartney  
Copyright © 1970 Sony/ATV Songs LLC  
Copyright Renewed  
All Rights Administered by Sony/ATV Music Publishing, 8 Music Square  
West, Nashville, TN 37203  
International Copyright Secured All Rights Reserved

**Let's Twist Again**

Words by Kal Mann  
Music by Dave Appell and Kal Mann  
Copyright © 1961 Kalmann Music, Inc.  
Copyright Renewed  
All Rights Controlled and Administered by Spirit Two Music, Inc.  
(ASCAP)  
International Copyright Secured All Rights Reserved

**Linus And Lucy**

By Vince Guaraldi  
Copyright © 1965 LEE MENDELSON FILM PRODUCTIONS, INC.  
Copyright Renewed  
International Copyright Secured All Rights Reserved

**Love Story**

Theme from the Paramount Picture LOVE STORY  
Music by Francis Lai  
Copyright © 1970, 1971 (Renewed 1998, 1999) by Famous Music  
Corporation  
International Copyright Secured All Rights Reserved

**Lullaby Of Birdland**

Words by George David Weiss  
Music by George Shearing  
© 1952, 1954 (Renewed 1980, 1982) EMI LONGITUDE MUSIC  
All Rights Reserved International Copyright Secured Used by  
Permission

**Michelle**

Words and Music by John Lennon and Paul McCartney  
Copyright © 1965 Sony/ATV Songs LLC  
Copyright Renewed  
All Rights Administered by Sony/ATV Music Publishing, 8 Music Square  
West, Nashville, TN 37203  
International Copyright Secured All Rights Reserved

**Mickey Mouse March**

from Walt Disney's THE MICKEY MOUSE CLUB  
Words and Music by Jimmie Dodd  
© 1955 Walt Disney Music Company  
Copyright Renewed  
All Rights Reserved Used by Permission

**Mission: Impossible Theme**

from the Paramount Television Series MISSION: IMPOSSIBLE  
By Lalo Schifrin  
Copyright © 1966, 1967 (Renewed 1994, 1995) by Bruin Music Company  
International Copyright Secured All Rights Reserved

**Mona Lisa**

from the Paramount Picture CAPTAIN CAREY, U.S.A.  
Words and Music by Jay Livingston and Ray Evans  
Copyright © 1949 (Renewed 1976) by Famous Music Corporation  
International Copyright Secured All Rights Reserved

**Moon River**

from the Paramount Picture BREAKFAST AT TIFFANY'S  
Words by Johnny Mercer  
Music by Henry Mancini  
Copyright © 1961 (Renewed 1989) by Famous Music Corporation  
International Copyright Secured All Rights Reserved

**Moonlight Serenade**

Words by Mitchell Parish  
Music by Glen Miller  
Copyright © 1939 (Renewed 1967) by ROBBINS MUSIC  
CORPORATION  
All Rights Controlled and Administered by EMI ROBBINS CATALOG  
INC.  
International Copyright Secured All Rights Reserved

**My Favorite Things**

from THE SOUND OF MUSIC  
Lyrics by Oscar Hammerstein II  
Music by Richard Rodgers  
Copyright © 1959 by Richard Rodgers and Oscar Hammerstein II  
Copyright Renewed  
WILLIAMSON MUSIC owner of publication and allied rights throughout  
the world  
International Copyright Secured All Rights Reserved

**My Way**

By Paul Anka, Jacques Revaux, Claude Francois and Giles Thibault  
© 1997 by Chrysalis Standards, Inc.  
Used by Permission. All Rights Reserved.

**The Nearness Of You**

from the Paramount Picture ROMANCE IN THE DARK  
Words by Ned Washington  
Music by Hoagy Carmichael  
Copyright © 1937, 1940 (Renewed 1964, 1967) by Famous Music  
Corporation  
International Copyright Secured All Rights Reserved

**Theme From "New York, New York"**

Music by John Kander  
Words by Fred Ebb  
© 1977 UNITED ARTISTS CORPORATION  
All Rights Controlled by EMI UNART CATALOG INC. (Publishing) and  
WARNER BROS. PUBLICATIONS U.S. INC. (Print)  
All Rights Reserved Used by Permission

**Ob-La-Di, Ob-La-Da**

Words and Music by John Lennon and Paul McCartney  
Copyright © 1968 Sony/ATV Songs LLC  
Copyright Renewed  
All Rights Administered by Sony/ATV Music Publishing, 8 Music Square  
West, Nashville, TN 37203  
International Copyright Secured All Rights Reserved

**Proud Mary**

Words and Music by J.C. Fogerty  
© 1968 (Renewed) JONDORA MUSIC  
All Rights Reserved Used by Permission

**Return To Sender**

Words and Music by Otis Blackwell and Winfield Scott  
Copyright © 1962 by Elvis Presley Music, Inc.  
Copyright Renewed and Assigned to Elvis Presley Music  
All Rights Administered by Cherry River Music Co. and Chrysalis Songs  
International Copyright Secured All Rights Reserved

**The Shoop Shoop Song (It's In His Kiss)**

Words and Music by Rudy Clark  
Copyright © 1963, 1964 by Trio Music Company, Inc. and Top Of The  
Charts  
Copyright Renewed  
All Rights for the United States Controlled and Administered by Trio  
Music Company, Inc.  
All Rights for the World excluding the United States Controlled and  
Administered by Trio Music Company, Inc. and Alley Music Corp.  
International Copyright Secured All Rights Reserved  
Used by Permission

**(Sittin' On) The Dock Of The Bay**

Words and Music by Steve Cropper and Otis Redding  
Copyright © 1968, 1975 IRVING MUSIC, INC.  
Copyright Renewed  
All Rights Reserved Used by Permission

**Smoke Gets In Your Eyes**

from ROBERTA  
Words by Otto Harbach  
Music by Jerome Kern  
© 1933 UNIVERSAL - POLYGRAM INTERNATIONAL PUBLISHING, INC.  
Copyright Renewed  
All Rights Reserved  
International Rights Secured. Not for broadcast transmission.  
DO NOT DUPLICATE. NOT FOR RENTAL.  
WARNING: It is a violation of Federal Copyright Law to synchronize this Multimedia Disc with video tape or film, or to print the Composition(s) embodied on this Multimedia Disc in the form of standard music notation, without the express written permission of the copyright owner.

**Somewhere, My Love**

Lara's Theme from DOCTOR ZHIVAGO  
Lyric by Paul Francis Webster  
Music by Maurice Jarre  
Copyright © 1965, 1966 (Renewed 1993, 1994) Webster Music Co. and EMI Robbins Catalog Inc.  
International Copyright Secured All Rights Reserved

**Spanish Eyes**

Words by Charles Singleton and Eddie Snyder  
Music by Bert Kaempfert  
© 1965, 1966 (Renewed 1993, 1994) EDITION DOMA BERT KAEMPFERT  
All Rights for the world, excluding Germany, Austria and Switzerland, Controlled and Administered by SCREEN GEMS-EMI MUSIC INC.  
All Rights Reserved International Copyright Secured Used by Permission

**Speak Softly, Love (Love Theme)**

from the Paramount Picture THE GODFATHER  
Words by Larry Kusik  
Music by Nino Rota  
Copyright © 1972 (Renewed 2000) by Famous Music Corporation  
International Copyright Secured All Rights Reserved

**Stella By Starlight**

from the Paramount Picture THE UNINVITED  
Words by Ned Washington  
Music by Victor Young  
Copyright © 1946 (Renewed 1973, 1974) by Famous Music Corporation  
International Copyright Secured All Rights Reserved

**Take The "A" Train**

Words and Music by Billy Strayhorn  
Copyright © 1941; Renewed 1969 DreamWorks Songs (ASCAP) and Billy Strayhorn Songs, Inc. (ASCAP) for the U.S.A.  
Rights for DreamWorks Songs and Billy Strayhorn Songs, Inc. Administered by Cherry Lane Music Publishing Company, Inc.  
International Copyright Secured All Rights Reserved

**Tears In Heaven**

Words and Music by Eric Clapton and Will Jennings  
Copyright © 1992 by E.C. Music Ltd. and Blue Sky Rider Songs  
All Rights for E.C. Music Ltd. Administered by Unichappell Music Inc.  
All Rights for Blue Sky Rider Songs Administered by Irving Music, Inc.  
International Copyright Secured All Rights Reserved

**That Old Black Magic**

from the Paramount Picture STAR SPANGLED RHYTHM  
Words by Johnny Mercer  
Music by Harold Arlen  
Copyright © 1942 (Renewed 1969) by Famous Music Corporation  
International Copyright Secured All Rights Reserved

**That's Amore (That's Love)**

from the Paramount Picture THE CADDY  
Words by Jack Brooks  
Music by Harry Warren  
Copyright © 1953 (Renewed 1981) by Paramount Music Corporation and Four Jays Music  
International Copyright Secured All Rights Reserved

**Up Where We Belong**

from the Paramount Picture AN OFFICER AND A GENTLEMAN  
Words by Will Jennings  
Music by Buffy Sainte-Marie and Jack Nitzsche  
Copyright © 1982 by Famous Music Corporation and Ensign Music Corporation  
International Copyright Secured All Rights Reserved

**Waltz For Debby**

Lyric by Gene Lees  
Music by Bill Evans  
TRO - © Copyright 1964 (Renewed), 1965 (Renewed), 1966 (Renewed) Folkways Music Publishers, Inc., New York, NY  
International Copyright Secured  
All Rights Reserved Including Public Performance For Profit  
Used by Permission

**White Christmas**

from the Motion Picture Irving Berlin's HOLIDAY INN  
Words and Music by Irving Berlin  
© Copyright 1940, 1942 by Irving Berlin  
Copyright Renewed  
International Copyright Secured All Rights Reserved

**A Whole New World**

from Walt Disney's ALADDIN  
Music by Alan Menken  
Lyrics by Tim Rice  
© 1992 Wonderland Music Company, Inc. and Walt Disney Music Company  
All Rights Reserved Used by Permission

**Yesterday**

Words and Music by John Lennon and Paul McCartney  
Copyright © 1965 Sony/ATV Songs LLC  
Copyright Renewed  
All Rights Administered by Sony/ATV Music Publishing, 8 Music Square West, Nashville, TN 37203  
International Copyright Secured All Rights Reserved

**You Are The Sunshine Of My Life**

Words and Music by Stevie Wonder  
© 1972 (Renewed 2000) JOBETE MUSIC CO., INC. and BLACK BULL MUSIC  
c/o EMI APRIL MUSIC INC.  
All Rights Reserved International Copyright Secured Used by Permission

**You Sexy Thing**

Words and Music by E. Brown  
Copyright © 1975 by Finchley Music Corp.  
Administered in the USA and Canada by Music & Media International, Inc.  
Administered for the World excluding the USA and Canada by RAK Music Publishing Ltd.  
International Copyright Secured All Rights Reserved

# MEMO

# MEMO

# Important Notice: Guarantee Information for customers in European Economic Area (EEA) and Switzerland

<p><b>Important Notice: Guarantee Information for customers in EEA* and Switzerland</b></p> <p>For detailed guarantee information about this Yamaha product, and Pan-EEA* and Switzerland warranty service, please either visit the website address below (Printable file is available at our website) or contact the Yamaha representative office for your country. * EEA: European Economic Area</p>	English
<p><b>Wichtiger Hinweis: Garantie-Information für Kunden in der EWR* und der Schweiz</b></p> <p>Für nähere Garantie-Information über dieses Produkt von Yamaha, sowie über den Pan-EWR*- und Schweizer Garantieservice, besuchen Sie bitte entweder die folgend angegebene Internetadresse (eine druckfähige Version befindet sich auch auf unserer Webseite), oder wenden Sie sich an den für Ihr Land zuständigen Yamaha-Vertrieb. * EWR: Europäischer Wirtschaftsraum</p>	Deutsch
<p><b>Remarque importante: informations de garantie pour les clients de l'EEE et la Suisse</b></p> <p>Pour des informations plus détaillées sur la garantie de ce produit Yamaha et sur le service de garantie applicable dans l'ensemble de l'EEE ainsi qu'en Suisse, consultez notre site Web à l'adresse ci-dessous (le fichier imprimable est disponible sur notre site Web) ou contactez directement Yamaha dans votre pays de résidence. * EEE : Espace Economique Européen</p>	Français
<p><b>Belangrijke mededeling: Garantie-informatie voor klanten in de EER* en Zwitserland</b></p> <p>Voor gedetailleerde garantie-informatie over dit Yamaha-product en de garantieservice in heel de EER* en Zwitserland, gaat u naar de onderstaande website (u vindt een afdrukbaar bestand op onze website) of neemt u contact op met de vertegenwoordiging van Yamaha in uw land. * EER: Europese Economische Ruimte</p>	Nederlands
<p><b>Aviso importante: información sobre la garantía para los clientes del EEE* y Suiza</b></p> <p>Para una información detallada sobre este producto Yamaha y sobre el soporte de garantía en la zona EEE* y Suiza, visite la dirección web que se incluye más abajo (la versión del archivo para imprimir esta disponible en nuestro sitio web) o póngase en contacto con el representante de Yamaha en su país. * EEE: Espacio Económico Europeo</p>	Español
<p><b>Avviso importante: informazioni sulla garanzia per i clienti residenti nell'EEA* e in Svizzera</b></p> <p>Per informazioni dettagliate sulla garanzia relativa a questo prodotto Yamaha e l'assistenza in garanzia nei paesi EEA* e in Svizzera, potete consultare il sito Web all'indirizzo riportato di seguito (è disponibile il file in formato stampabile) oppure contattare l'ufficio di rappresentanza locale della Yamaha. * EEA: Area Economica Europea</p>	Italiano
<p><b>Aviso importante: informações sobre as garantias para clientes da AEE* e da Suíça</b></p> <p>Para obter uma informação pormenorizada sobre este produto da Yamaha e sobre o serviço de garantia na AEE* e na Suíça, visite o site a seguir (o arquivo para impressão está disponível no nosso site) ou entre em contato com o escritório de representação da Yamaha no seu país. * AEE: Área Económica Européia</p>	Português
<p><b>Σημαντική σημείωση: Πληροφορίες εγγύησης για τους πελάτες στον ΕΟΧ* και Ελλάδα</b></p> <p>Για λεπτομερείς πληροφορίες εγγύησης σχετικά με το παρόν προϊόν της Yamaha και την κάλυψη εγγύησης σε όλες τις χώρες του ΕΟΧ και την Ελλάδα, επισκεφτείτε την παρακάτω ιστοσελίδα (Εκτυπώσιμη μορφή είναι διαθέσιμη στην ιστοσελίδα μας) ή απευθυνθείτε στην αντιπροσωπεία της Yamaha στη χώρα σας. * ΕΟΧ: Ευρωπαϊκός Οικονομικός Χώρος</p>	Ελληνικά
<p><b>Viktigt: Garantinformation för kunder i EES-området* och Schweiz</b></p> <p>För detaljerad information om denna Yamahaprodukt samt garantiservice i hela EES-området* och Schweiz kan du antingen besöka nedanstående webbadress (en utskriftsvänlig fil finns på webbplatsen) eller kontakta Yamahas officiella representant i ditt land. * EES: Europeiska Ekonomiska Samarbetsområdet</p>	Svenska
<p><b>Viktig merknad: Garantinformasjon for kunder i EØS* og Sveits</b></p> <p>Detaljert garantinformasjon om dette Yamaha-produktet og garantiservice for hele EØS-området* og Sveits kan fås enten ved å besøke nettstedene nedenfor (utskriftsversjon finnes på våre nettsider) eller kontakte Yamahas kontorene i landet der du bor. *EØS: Det europeiske økonomiske samarbeidsområdet</p>	Norsk
<p><b>Vigtig oplysning: Garantiplysninger til kunder i EØO* og Schweiz</b></p> <p>De kan finde detaljerede garantiplysninger om dette Yamaha-produkt og den fælles garantiserviceordning for EØO* (og Schweiz) ved at besøge det websted, der er angivet nedenfor (der findes en fil, som kan udskrives, på vores websted), eller ved at kontakte Yamahas nationale repræsentationskontor i det land, hvor De bor. * EØO: Det Europæiske Økonomiske Område</p>	Dansk
<p><b>Tärkeä ilmoitus: Takuutiedot Euroopan talusalueen (ETA) ja Sveitsin asiakkaille</b></p> <p>Tämän Yamaha-tuotteen sekä ETA-alueen ja Sveitsin takuuta koskevat yksityiskohtaiset tiedot saatte alla olevasta nettiosoitteesta. (Tulostettava tiedosto saatavissa sivustollamme.) Voitte myös ottaa yhteyttä paikalliseen Yamaha-edustajaan. *ETA: Euroopan talusalue</p>	Suomi
<p><b>Ważne: Warunki gwarancyjne obowiązujące w EOG* i Szwajcarii</b></p> <p>Aby dowiedzieć się więcej na temat warunków gwarancyjnych tego produktu firmy Yamaha i serwisu gwarancyjnego w całym EOG* i Szwajcarii, należy odwiedzić wskazaną poniżej stronę internetową (Plik gotowy do wydruku znajduje się na naszej stronie internetowej) lub skontaktować się z przedstawicielem firmy Yamaha w swoim kraju. * EOG — Europejski Obszar Gospodarczy</p>	Polski
<p><b>Důležité oznámení: Záruční informace pro zákazníky v EHS* a ve Švýcarsku</b></p> <p>Podrobné záruční informace o tomto produktu Yamaha a záručním servisu v celém EHS* a ve Švýcarsku naleznete na níže uvedené webové adrese (soubor k tisku je dostupný na našich webových stránkách) nebo se můžete obrátit na zastoupení firmy Yamaha ve své zemi. * EHS: Evropský hospodářský prostor</p>	Česky
<p><b>Fontos figyelmeztetés: Garancia-információk az EGT* területén és Svájcban élő vásárlók számára</b></p> <p>A jelen Yamaha termékre vonatkozó részletes garancia-információk, valamint az EGT*-re és Svájcra kiterjedő garanciális szolgáltatás tekintetében keresse fel webhelyünk az alábbi címen (a webhelyen nyomtatható fájl is talál), vagy pedig lépjen kapcsolatba az országában működő Yamaha képviselői irodával. * EGT: Európai Gazdasági Térség</p>	Magyar
<p><b>Ouline märkus: Garantiteave Euroopa Majanduspiirkonna (EMP)* ja Šveitsi klientidele</b></p> <p>Täpsema teabe saamiseks selle Yamaha toote garantii ning kogu Euroopa Majanduspiirkonna ja Šveitsi garantiiteeninduse kohta, külastage palun veebisaiti alljärgneval aadressil (meie saidil on saadaval printitav fail) või pöörduge Teie regiooni Yamaha esinduse poole. * EMP: Euroopa Majanduspiirkond</p>	Eesti keel
<p><b>Svarīgs paziņojums: garantijas informācija klientiem EEZ* un Šveicē</b></p> <p>Lai saņemtu detalizētu garantijas informāciju par šo Yamaha produktu, kā arī garantijas apkalpošanu EEZ* un Šveicē, lūdzam, apmeklējiet zemāk norādīto tīmekļa vietnes adresi (tīmekļa vietnē ir pieejams drukājams fails) vai sazinieties ar jūsu valsti apkalpojošo Yamaha pārstāvniecību. * EEZ: Eiropas Ekonomikas zona</p>	Latviešu
<p><b>Démesio: informacija dėl garantijos pirkėjams EEE* ir Šveicarijoje</b></p> <p>Jei reikia išsamios informacijos apie šį „Yamaha“ produktą ir jo techninę priežiūrą visoje EEE* ir Šveicarijoje, apsilankykite mūsų svetainėje toliau nurodytu adresu (svetainėje yra spausdintinas failas) arba kreipkitės į „Yamaha“ atstovybę savo šaliai. *EEE – Europos ekonominė erdvė</p>	Lietuvių kalba
<p><b>Dôležité upozornenie: Informácie o záruke pre zákazníkov v EHP* a Švajčiarsku</b></p> <p>Podrobné informácie o záruke týkajúce sa tohto produktu od spoločnosti Yamaha a garančnom servise v EHP* a Švajčiarsku nájdete na webovej stránke uvedenej nižšie (na našej webovej stránke je k dispozícii súbor na tlač) alebo sa obráťte na zástupcu spoločnosti Yamaha vo svojej krajine. * EHP: Európsky hospodársky priestor</p>	Slovenčina
<p><b>Pomembno obvestilo: Informacije o garanciji za kupce v EGP* in Švici</b></p> <p>Za podrobnejše informacije o tem Yamahinem izdelku ter garancijskem servisu v celotnem EGP in Švici, obiščite spletno mesto, ki je navedeno spodaj (natisljiva datoteka je na voljo na našem spletnem mestu), ali se obrnite na Yamahinega predstavnika v svoji državi. * EGP: Evropski gospodarski prostor</p>	Slovenščina
<p><b>Важно съобщение: Информация за гаранцията за клиенти в ЕИП* и Швейцария</b></p> <p>За подробна информация за гаранцията за този продукт на Yamaha и гаранционното обслужване в паневропейската зона на ЕИП* и Швейцария или посетете посочения по-долу уеб сайт (на нашия уеб сайт има файл за печат), или се свържете с представителния офис на Yamaha във вашата страна. * ЕИП: Европейско икономическо пространство</p>	Български език
<p><b>Notificare importantă: Informații despre garanție pentru clienții din SEE* și Elveția</b></p> <p> Pentru informații detaliate privind acest produs Yamaha și serviciul de garanție Pan-SEE* și Elveția, vizitați site-ul la adresa de mai jos (fișierul imprimabil este disponibil pe site-ul nostru) sau contactați biroul reprezentanței Yamaha din țara dumneavoastră. * SEE: Spațiul Economic European</p>	Limba română

<http://europe.yamaha.com/warranty/>

For details of products, please contact your nearest Yamaha representative or the authorized distributor listed below.

Pour plus de détails sur les produits, veuillez-vous adresser à Yamaha ou au distributeur le plus proche de vous figurant dans la liste suivante.

Die Einzelheiten zu Produkten sind bei Ihrer unten aufgeführten Niederlassung und bei Yamaha Vertragshändlern in den jeweiligen Bestimmungsländern erhältlich.

Para detalles sobre productos, contacte su tienda Yamaha más cercana o el distribuidor autorizado que se lista debajo.

## NORTH AMERICA

### CANADA

**Yamaha Canada Music Ltd.**  
135 Milner Avenue, Toronto, Ontario M1S 3R1,  
Canada  
Tel: +1-416-298-1311

### U.S.A.

**Yamaha Corporation of America**  
6600 Orangethorpe Avenue, Buena Park, CA 90620,  
U.S.A.  
Tel: +1-714-522-9011

## CENTRAL & SOUTH AMERICA

### MEXICO

**Yamaha de México, S.A. de C.V.**  
Av. Insurgentes Sur 1647 Piso 9, Col. San José  
Insurgentes, Delegación Benito Juárez, México,  
D.F., C.P. 03900  
Tel: +52-55-5804-0600

### BRAZIL

**Yamaha Musical do Brasil Ltda.**  
Via Fidêncio Ramos, 302 – Cj 52 e 54 – Torre B –  
Rua Olímpia – CEP 04551-010 – São Paulo/SP,  
Brazil  
Tel: +55-11-3704-1377

### ARGENTINA

**Yamaha Music Latin America, S.A.,  
Sucursal Argentina**  
Olga Cossetini 1553, Piso 4 Norte,  
Madero Este-C1107CEK,  
Buenos Aires, Argentina  
Tel: +54-11-4119-7000

### VENEZUELA

**Yamaha Music de Venezuela, C.A.**  
AV. Manzanares, C.C. Manzanares Plaza,  
Piso 4, Oficina 0401, Baruta, Caracas, Venezuela  
Tel: +58-212-943-1877

### PANAMA AND OTHER LATIN AMERICAN COUNTRIES/ CARIBBEAN COUNTRIES

**Yamaha Music Latin America, S.A.**  
Edif. Torre Banco General, F7, Urb. Marbella,  
Calle 47 y Aquilino de la Guardia, Panama,  
P.O.Box 0823-05863, Panama, Rep. de Panama  
Tel: +507-269-5311

## EUROPE

### THE UNITED KINGDOM/IRELAND

**Yamaha Music Europe GmbH (UK)**  
Sherbourne Drive, Tilbrook, Milton Keynes,  
MK7 8BL, U.K.  
Tel: +44-1908-366700

### GERMANY

**Yamaha Music Europe GmbH**  
Siemensstrasse 22-34, 25462 Rellingen, Germany  
Tel: +49-4101-303-0

### SWITZERLAND/LIECHTENSTEIN

**Yamaha Music Europe GmbH, Rellingen,  
Branch Switzerland in Zürich**  
Seefeldstrasse 94, 8008 Zürich, Switzerland  
Tel: +41-44-3878080

### AUSTRIA

**Yamaha Music Europe GmbH, Branch Austria**  
Schleiergasse 20, 1100 Wien, Austria  
Tel: +43-1-60203900

### CZECH REPUBLIC/HUNGARY/ ROMANIA/SLOVAKIA/SLOVENIA

**Yamaha Music Europe GmbH, Branch Austria**  
Schleiergasse 20, 1100 Wien, Austria  
Tel: +43-1-60203900

### POLAND/LITHUANIA/LATVIA/ ESTONIA

**Yamaha Music Europe GmbH**  
Sp.z o.o. Oddział w Polsce  
ul. Wrotkowa 14, 02-553 Warsaw, Poland  
Tel: +48-22-880-08-88

### BULGARIA

**Dinacord Bulgaria LTD.**  
Bul. Iskarsko Schose 7 Targowski Zentar Ewropa  
1528 Sofia, Bulgaria  
Tel: +359-2-978-20-25

### MALTA

**Olimpus Music Ltd.**  
Valletta Road, Mosta MST9010, Malta  
Tel: +356-2133-2093

### NETHERLANDS/BELGIUM/ LUXEMBOURG

**Yamaha Music Europe, Branch Benelux**  
Clarissenhof 5b, 4133 AB Vianen, The Netherlands  
Tel: +31-347-358040

### FRANCE

**Yamaha Music Europe**  
7 rue Ambroise Croizat, Zone d'activités de Pariest,  
77183 Croissy-Beaubourg, France  
Tel: +33-1-6461-4000

### ITALY

**Yamaha Music Europe GmbH, Branch Italy**  
Viale Italia 88, 20020, Lainate (Milano), Italy  
Tel: +39-02-93577-1

### SPAIN/PORTUGAL

**Yamaha Music Europe GmbH Ibérica, Sucursal  
en España**  
Ctra. de la Coruna km. 17,200, 28231  
Las Rozas de Madrid, Spain  
Tel: +34-91-639-88-88

### GREECE

**Philippos Nakas S.A. The Music House**  
19th klm. Leof. Lavriou 190 02 Peania – Attiki,  
Greece  
Tel: +30-210-6686260

### SWEDEN

**Yamaha Music Europe GmbH Germany filial  
Scandinavia**  
JA Wettergrensgata 1, 421 30 Västra Frölunda,  
Sweden  
Tel: +46-31-89-34-00

### DENMARK

**Yamaha Music Denmark,  
Filial of Yamaha Music Europe GmbH, Tyskland**  
Generatorvej 8C, ST. TH., 2860 Søborg, Denmark  
Tel: +45-44-92-49-00

### FINLAND

**F-Musiikki Oy**  
Kluuvikatu 6, P.O. Box 260,  
SF-00101 Helsinki, Finland  
Tel: +358-9-618511

### NORWAY

**Yamaha Music Europe GmbH Germany -  
Norwegian Branch**  
Grini Næringspark 1, 1361 Østerås, Norway  
Tel: +47-6716-7800

### ICELAND

**Skifan HF**  
Skeifan 17 P.O. Box 8120, IS-128 Reykjavik,  
Iceland  
Tel: 525 5000

### RUSSIA

**Yamaha Music (Russia) LLC.**  
Room 37, entrance 7, bld. 7, Kievskaya street,  
Moscow, 121059, Russia  
Tel: +7-495-626-5005

### TURKEY/CYPRUS

**Yamaha Music Europe GmbH**  
**Merkezi Almanya Türkiye Istanbul Şubesi**  
Maslak Meydanı Sodak No:5 Spring Giz Plaza  
Bağımsız Böl. No:3, 34398 Şişli, Istanbul, Turkey  
Tel: +90-212-999-8010

### OTHER EUROPEAN COUNTRIES

**Yamaha Music Europe GmbH**  
Siemensstrasse 22-34, 25462 Rellingen, Germany  
Tel: +49-4101-303-0

## AFRICA/MIDDLE EAST

### SOUTH AFRICA

**Yamaha Music Gulf FZE South Africa Office**  
19 Eastern Service Road, Eastgate Ext.6, Sandton,  
Johannesburg, Republic of South Africa  
Tel: +27-11-656-4468

### OTHER COUNTRIES

**Yamaha Music Gulf FZE**  
JAFZA-16, Office 512, P.O.Box 17328,  
Jebel Ali FZE, Dubai, UAE  
Tel: +971-4-801-1500

## ASIA

### THE PEOPLE'S REPUBLIC OF CHINA

**Yamaha Music & Electronics (China) Co., Ltd.**  
2F, Yunhedasha, 1818 Xinzha-lu, Jingan-qu,  
Shanghai, China  
Tel: +86-400-051-7700

### HONG KONG

**Tom Lee Music Co., Ltd.**  
11/F., Silvercord Tower 1, 30 Canton Road,  
Tsimshatsui, Kowloon, Hong Kong  
Tel: +852-2737-7688

### INDIA

**Yamaha Music India Private Limited**  
Spazedge Building, Ground Floor, Tower A,  
Sector-47, Gurgaon- Sohna Road, Gurgaon-122002,  
Haryana, India  
Tel: +91-124-485-3300

### INDONESIA

**PT. Yamaha Musik Indonesia (Distributor)**  
Yamaha Music Center Bldg. Jalan Jend. Gatot  
Subroto Kav. 4, Jakarta 12930, Indonesia  
Tel: +62-21-520-2577

### KOREA

**Yamaha Music Korea Ltd.**  
8F, Dongsung Bldg. 21, Teheran-ro 87-gil,  
Gangnam-gu, Seoul, 135-880, Korea  
Tel: +91-124-485-3300

### MALAYSIA

**Yamaha Music (Malaysia) Sdn. Bhd.**  
No.8, Jalan Perbandaran, Kelana Jaya, 47301  
Petaling Jaya, Selangor, Malaysia  
Tel: +60-3-78030900

### SINGAPORE

**Yamaha Music (Asia) Private Limited**  
Block 202 Hougang Street 21, #02-00,  
Singapore 530202, Singapore  
Tel: +65-6740-9200

### TAIWAN

**Yamaha Music & Electronics Taiwan Co., Ltd.**  
2F, No.1, Yuandong Rd. Banqiao Dist.  
New Taipei City 22063, Taiwan  
Tel: +886-2-7741-8888

### THAILAND

**Siam Music Yamaha Co., Ltd.**  
3, 4, 15, 16th Fl., Siam Motors Building,  
891/1 Rama 1 Road, Wangmai,  
Pathumwan, Bangkok 10330, Thailand  
Tel: +66-2215-2622

### VIETNAM

**Yamaha Music Vietnam Company Limited**  
15th Floor, Nam A Bank Tower, 201-203 Cach  
Mang Thang Tam St., Ward 4, Dist.3,  
Ho Chi Minh City, Vietnam  
Tel: +84-8-3818-1122

### OTHER ASIAN COUNTRIES

<http://asia.yamaha.com>

## OCEANIA

### AUSTRALIA

**Yamaha Music Australia Pty. Ltd.**  
Level 1, 99 Queensbridge Street, Southbank,  
Vic. 3006, Australia  
Tel: +61-3-9693-5111

### NEW ZEALAND

**Music Works LTD**  
P.O. BOX 6246 Wellesley, Auckland 4680,  
New Zealand  
Tel: +64-9-634-0099

### COUNTRIES AND TRUST TERRITORIES IN PACIFIC OCEAN

<http://asia.yamaha.com>



**Yamaha Global Site**  
<http://www.yamaha.com/>

**Yamaha Downloads**  
<http://download.yamaha.com/>

Manual Development Department  
© 2015 Yamaha Corporation

Published 06/2015 MWGR\*.\*- \*\*B0  
Printed in Indonesia



ZN97360

ZN97360