

YAMAHA TX-930 *RS*

Natural Sound AM/FM Stereo Tuner
24 Station Random Access Preset Tuning
Multi-Status Station Memory
Computer Servo Lock (CSL) System
IF Mode buttons
2 FM Outdoor Antenna Installation Capability

Thank you for selecting the YAMAHA model TX-930 AM/FM Stereo Tuner.



CONTENTS

Safety Instructions	2
Caution	3
Supplied Accessories	6
Connections to the Amplifier	7
Antenna Connections	7
Front Panel Components and Their Functions	11
Remote Control Transmitter	14
Operation	15
Troubleshooting	17
Specifications	18

OWNER'S MANUAL



IMPORTANT!

Please make a note of the serial number of this unit in the space indicated below.

Model: **TX-930**
Serial No.:

The serial number is inscribed on the rear of the unit. Keep this Owner's Manual in a safe place for future reference.

SAFETY INSTRUCTIONS

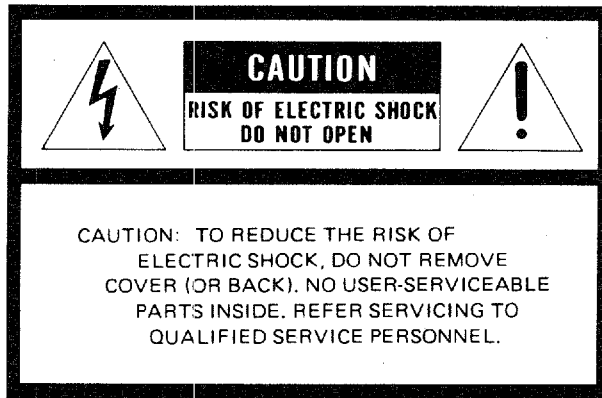

- Explanation of Graphical Symbols

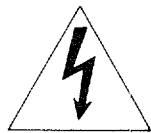

The lightning flash with arrowhead symbol, within an equilateral triangle, is intended to alert you to the presence of uninsulated "dangerous voltage" within the product's enclosure that may be of sufficient magnitude to constitute a risk of electric shock to persons.



The exclamation point within an equilateral triangle is intended to alert you to the presence of important operating and maintenance (servicing) instructions in the literature accompanying the appliance.

WARNING

To reduce the risk of fire or electric shock, do not expose this appliance to rain or moisture.

1 Read Instructions – All the safety and operating instructions should be read before the appliance is operated.

2 Retain Instructions – The safety and operating instructions should be retained for future reference.

3 Heed Warnings – All warnings on the appliance and in the operating instructions should be adhered to.

4 Follow Instructions – All operating and other instructions should be followed.

5 Water and Moisture – The appliance should not be used near water – for example, near a bathtub, washbowl, kitchen sink, laundry tub, in a wet basement, or near a swimming pool, etc.

6 Carts and Stands – The appliance should be used only with a cart or stand that is recommended by the manufacturer.

6A An appliance and cart combination should be moved with care. Quick stops, excessive force, and uneven surfaces may cause the appliance and cart combination to overturn.



7 Wall or Ceiling Mounting – The appliance should be mounted to a wall or ceiling only as recommended by the manufacturer.

8 Ventilation – The appliance should be situated so that its location or position does not interfere with its proper ventilation. For example, the appliance should not be situated on a bed, sofa, rug, or similar surface, that may block the ventilation openings; or placed in a built-in installation, such as a bookcase or cabinet that may impede the flow of air through the ventilation openings.

9 Heat – The appliance should be situated away from heat sources such as radiators, stoves, or other appliances that produce heat.

10 Power Sources – The appliance should be connected to a power supply only of the type described in the operating instructions or as marked on the appliance.

11 Power-Cord Protection – Power-supply cords should be routed so that they are not likely to be walked on or pinched by items placed upon or against them, paying particular attention to cords at plugs, convenience receptacles, and the point where they exit from the appliance.

12 Cleaning – The appliance should be cleaned only as recommended by the manufacturer.

13 Nonuse Periods – The power cord of the appliance should be unplugged from the outlet when left unused for a long period of time.

14 Object and Liquid Entry – Care should be taken so that objects do not fall into and liquids are not spilled into the inside of the appliance.

CAUTION : READ THIS BEFORE OPERATING YOUR UNIT

15 Damage Requiring Service – The appliance should be serviced by qualified service personnel when:

- A. The power-supply cord or the plug has been damaged; or
- B. Objects have fallen, or liquid has been spilled into the appliance; or
- C. The appliance has been exposed to rain; or
- D. The appliance does not appear to operate normally or exhibits a marked change in performance; or
- E. The appliance has been dropped, or the cabinet damaged.

16 Servicing – The user should not attempt to service the appliance beyond those means described in the operating instructions. All other servicing should be referred to qualified service personnel.

17 Power Lines – An outdoor antenna should be located away from power lines.

18 Grounding or Polarization – The precautions should be taken so that the grounding or polarization is not defeated.

19 Outdoor Antenna Grounding – If an outside antenna is connected to this unit, be sure the antenna system is grounded so as to provide some protection against voltage surges and built up static charges. Section 810 of the National Electrical Code, ANSI/NFPA No. 70-1984, provides information with respect to proper grounding of the mast and supporting structure, grounding of the lead-in wire to an antenna discharge unit, size of grounding conductors, location of antenna-discharge unit, connection to grounding electrodes, and requirements for the grounding electrode.

EXAMPLE OF ANTENNA GROUNDING ACCORDING TO NATIONAL ELECTRICAL CODE INSTRUCTIONS (CONTAINED IN ARTICLE 180 – "RADIO AND TELEVISION EQUIPMENT")

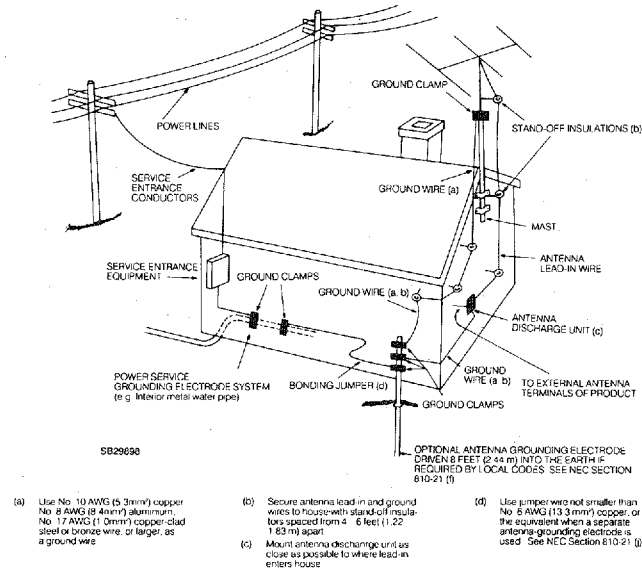

Note to CATV system installer:
This reminder is provided to call the CATV system installer's attention to Article 820-22 of the NEC that provides guidelines for proper grounding and, in particular, specifies that the cable ground shall be connected to the grounding system of the building as close to the point of cable entry as practical.

1. This unit is a sophisticated AM/FM stereo tuner. To ensure proper operation for the best possible performance, please read this manual carefully.
2. Choose the installation location of this unit carefully. Avoid placing it in direct sunlight or close to a source of heat. Also avoid locations subject to vibration and excessive dust, heat, cold or moisture. Keep it away from such sources of hum as transformers or motors.
3. Do not open the cabinet as this might result in damage to the set, or electrical shock. If a foreign object should get into the set, contact your dealer.
4. To prevent lightning damage, pull out the power cord and remove the antenna cable during an electrical storm.
5. When removing the power plug from the wall outlet, always pull directly on the plug; never pull the cord itself.
6. Do not use force when using the switches.
7. When moving the set be sure to first pull out the power plug and remove cords connected to other equipment.
8. Do not attempt to clean this unit with chemical solvent as this might damage the finish. Use a clean, dry cloth.
9. Be sure to read the "Troubleshooting" section for advice on common operating errors before concluding that this unit is faulty.
10. Keep this manual in a safe place for future reference.

1 U.S.A., Canada and General models

Australia, Europe and U.K. models

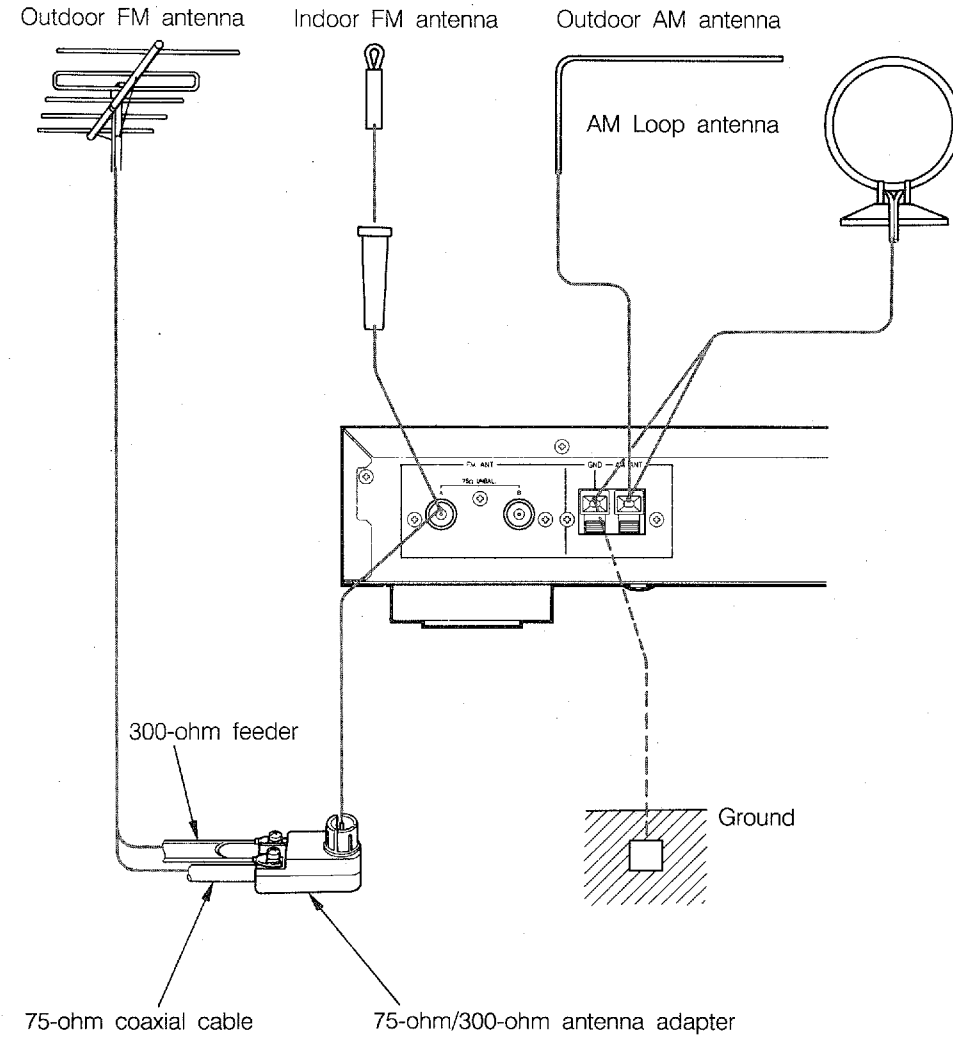
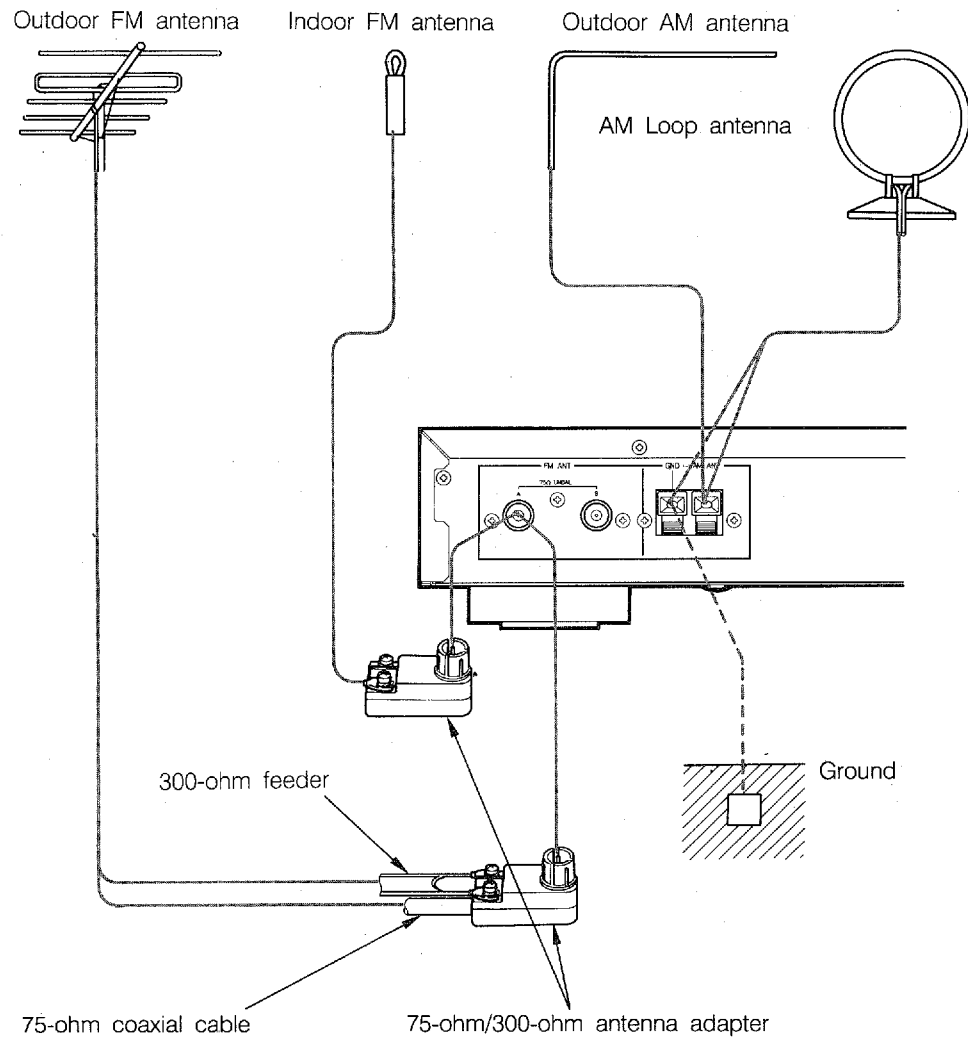

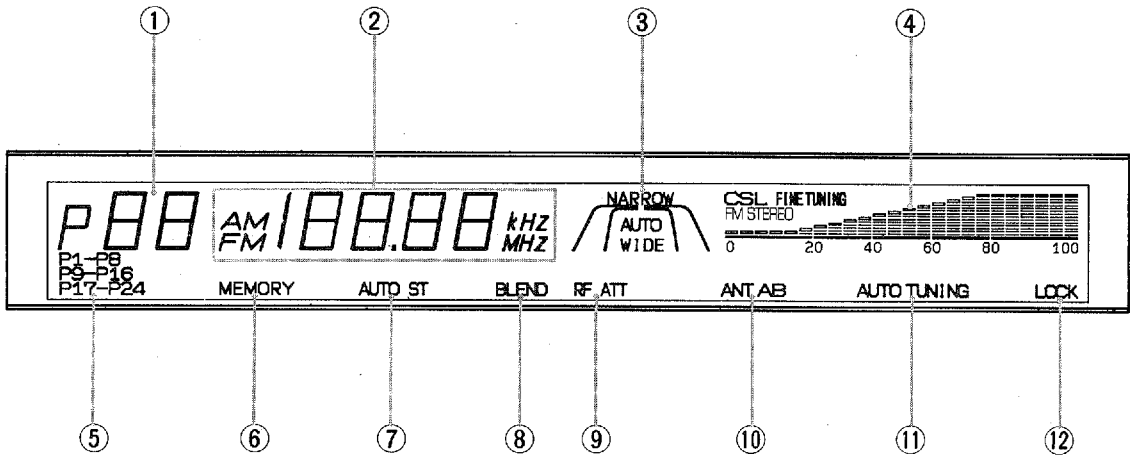
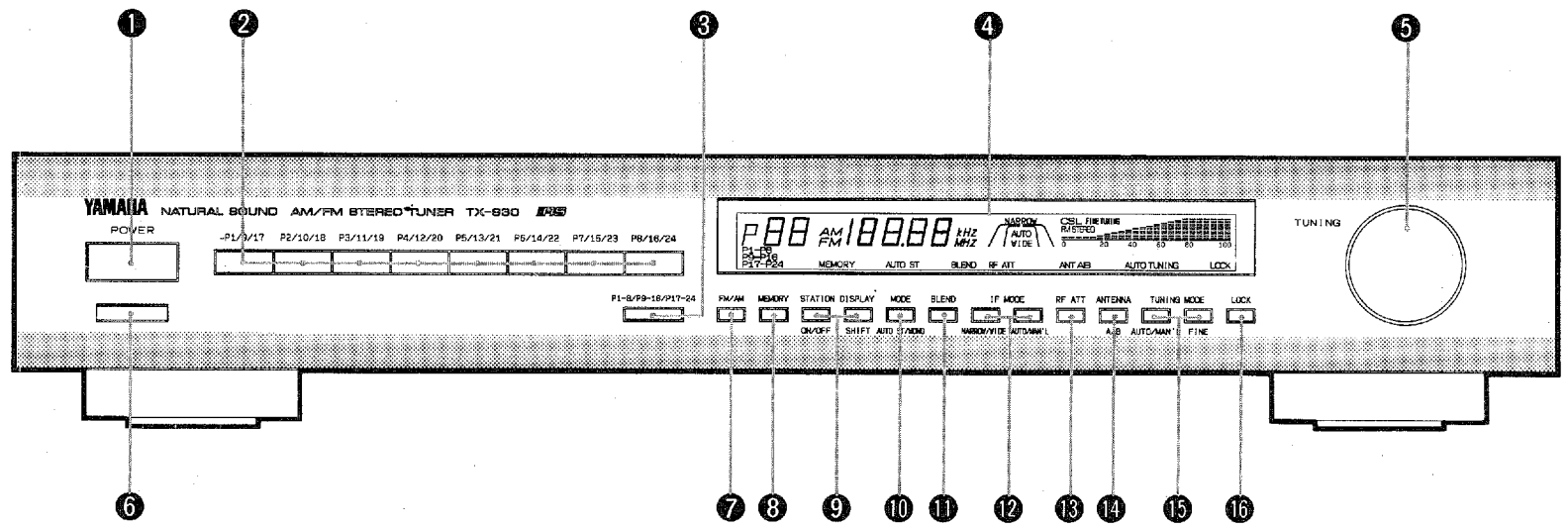

SUPPLIED ACCESSORIES

- AM Loop Antenna

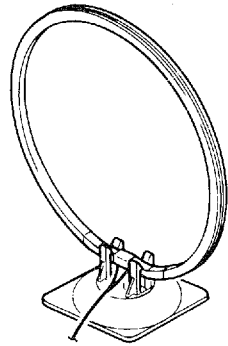

- Connection cords

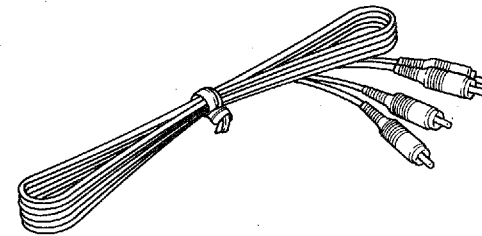

- Indoor FM Antenna

(U.S.A., Canada and General models)

(Australia, Europe and U.K. models)

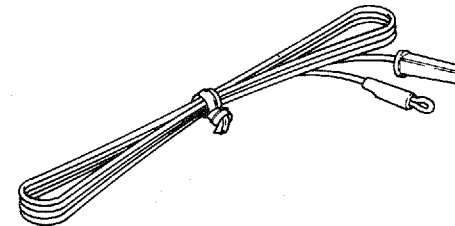
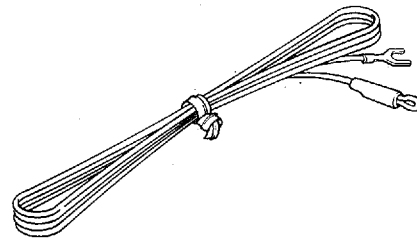

- 75-ohm/300-ohm Antenna Adapter

(U.S.A., Canada and General models)

(Australia, Europe and U.K. models)

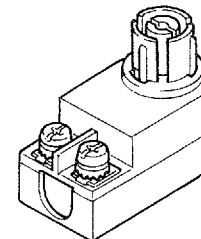
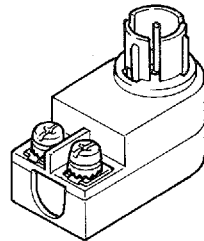

CONNECTIONS TO THE AMPLIFIER

- Before making any connections, switch OFF the power to this unit and the amplifier or other component.
- Be sure that the connections from the left ("L") OUTPUT terminal and from the right ("R") terminal are to the correct corresponding (left and right) input terminals of the amplifier or other component.
- Connections should be made to the correct input terminals of the amplifier or other component by using the provided connection cords. Refer to that component's operation manual besides this manual for details.

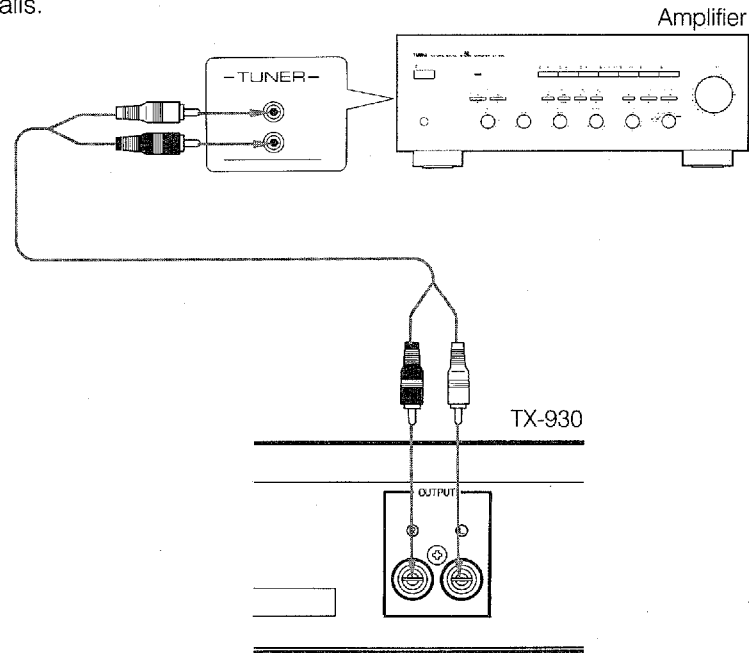

GND terminal

For maximum safety and minimum interference, connect the GND terminal to a good earth ground if practicable. A good earth ground is a metal stake driven into moist earth.

ANTENNA CONNECTIONS

(See Fig. 1.)

Both AM and FM indoor antennas are included with this unit. In general, these antennas will probably provide sufficient sensitivity. Furthermore, a properly installed outdoor antenna will give clearer reception than an indoor one. If you experience poor reception quality, an outdoor antenna may result in improvement.

AM ANTENNAS

Included indoor AM loop antenna

The included AM loop antenna is designed for indoor use only. Connect the AM antenna lead wires to the AM ANT terminals.

- ① Depress the tabs of the AM ANT terminals.
- ② Connect the AM loop antenna lead wires to the AM ANT terminals.
- ③ Release the tabs. Lightly pull on the lead wires to confirm a good connection.

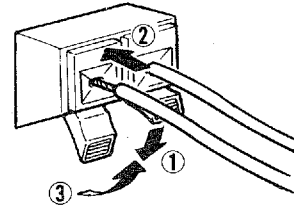

- ④ Attach the loop antenna to the antenna stand.

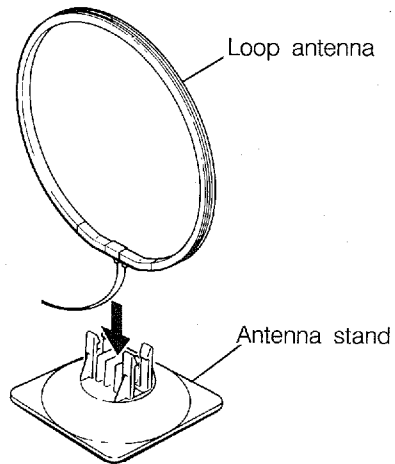

- ⑤ Tune to an AM station and then position the loop antenna for best reception. Orient the AM loop antenna so that the best reception is obtained. Try other stations, and find the position that gives the best overall reception.

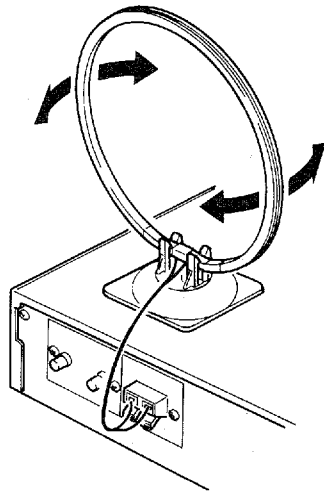

Optional outdoor AM antenna

In steel buildings or at a great distance from the transmitter, it may be necessary to install an outside long wire antenna. The end of the wire should be stripped of insulation and connected to the AM ANT terminal. At this time, also leave the loop antenna connected.

■ FM ANTENNAS

This tuner approaches the theoretical limit for FM sensitivity. However, the performance of this system is determined to a very large extent upon the signal conditions where the antenna is placed. This is because FM broadcast signals travel in straight paths, and, therefore, they can be blocked by natural or man-made obstructions such as mountains, hills, or buildings, and moreover, at a great distance from the transmitter, the curvature of the earth also presents an obstacle to good reception. If you live in an urban area, the included indoor antenna may be adequate, but if reception is weak, an outdoor antenna may improve reception.

Included indoor FM antenna

(U.S.A., Canada and General models)

Connect the included indoor antenna to the right terminal on the included 75-ohm/300-ohm antenna adapter, and then insert it into the A or B 75Ω UNBAL FM ANT terminal. Move and position the antenna until the best reception is obtained.

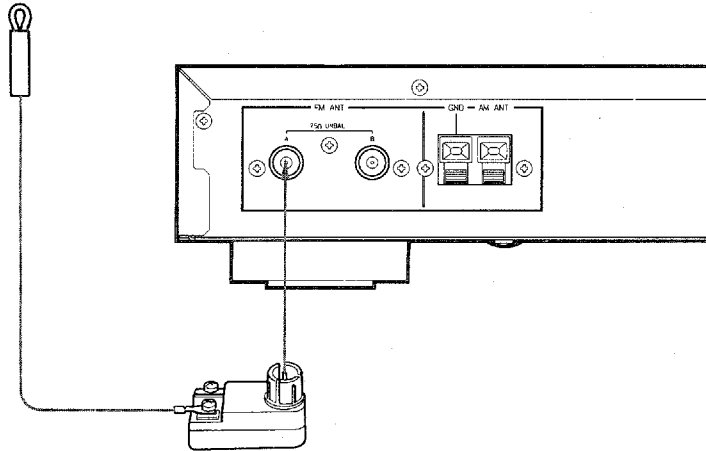

(Australia, U.K. and Europe models)

Connect the included indoor antenna to the A or B 75Ω UNBAL FM ANT terminal.

* Insert so that the grooved part of the connector hole is facing downward when the connection is made.

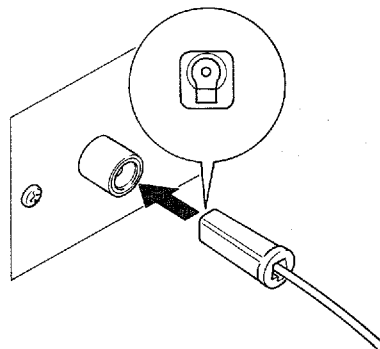

Optional outdoor FM antenna

Consult with your dealer or service personnel about the best method of selecting and erecting an outdoor FM antenna.

The choice of the feeder cable is also important. Flat ribbon-shaped twin-lead cable performs well electrically, and is cheaper and somewhat easier to handle when routing it through windows and around rooms. Coaxial cable is more expensive, does a much better job of minimizing interference, is less prone to the effects of weather and close-by metal objects, and is nearly as good a signal conductor as feeder cable, particularly for foam-type coaxial cables. Coaxial cable is somewhat more difficult to install at the point where the cable enters the building. If coaxial cable is selected, make sure the antenna is designed to be used with that type of cable.

Note

An FM outdoor antenna can be connected to the tuner by using either a 75Ω coaxial cable or a 300Ω feeder cable. For proper connection, carefully read the instruction manual for the FM outdoor antenna.

Notes for FM antenna installation

- To minimize automobile ignition noise, locate the antenna as far from heavy traffic as possible.
- Keep the feeder cable or coaxial cable as short as possible. Do not bundle or roll up excess cable.
- The antenna should be at least two meters (6.6 feet) from reinforced concrete walls or metal structures.

Using two FM outdoor antennas

Because this unit is equipped with A and B antenna terminals, two FM outdoor antennas, oriented in different directions, can be connected, and you can easily select either the A or B antenna with the ANTENNA A/B button on the front panel, so this method of antenna installation is a good way to receive high-quality signals in an area where broadcast transmitting stations exist in different directions.

Install one antenna at least 2 meters above (or below) the other and orient each antenna in the direction of a different broadcast transmitting station.

● **75-ohm coaxial cable connection**

1. Connect the coaxial cable to the included 75-ohm/300-ohm antenna adapter.

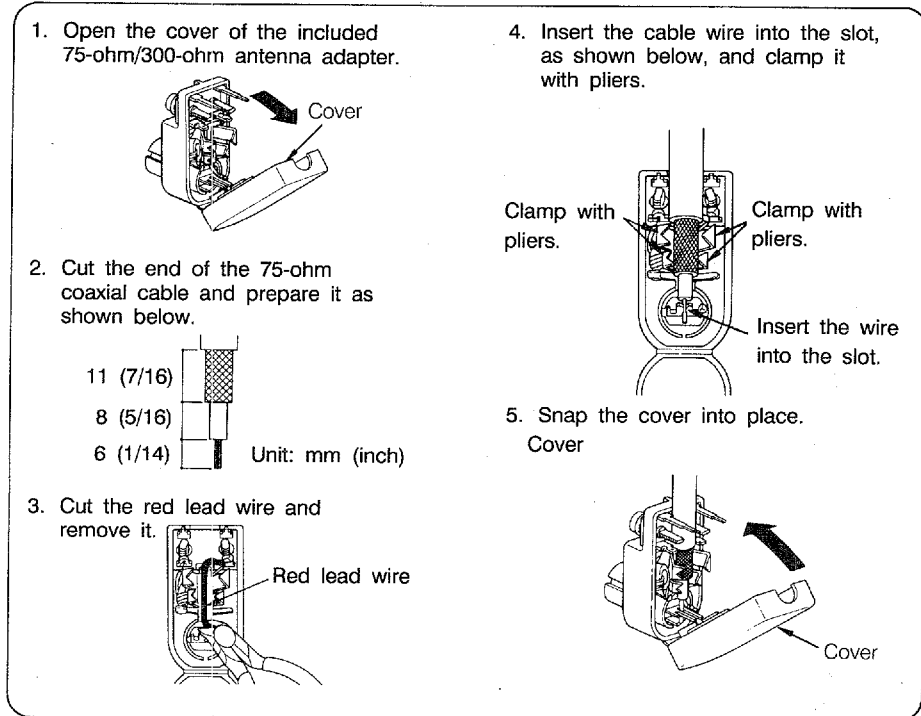

2. Insert the adapter(s) into the A and/or B 75Ω UNBAL FM ANT terminal(s).

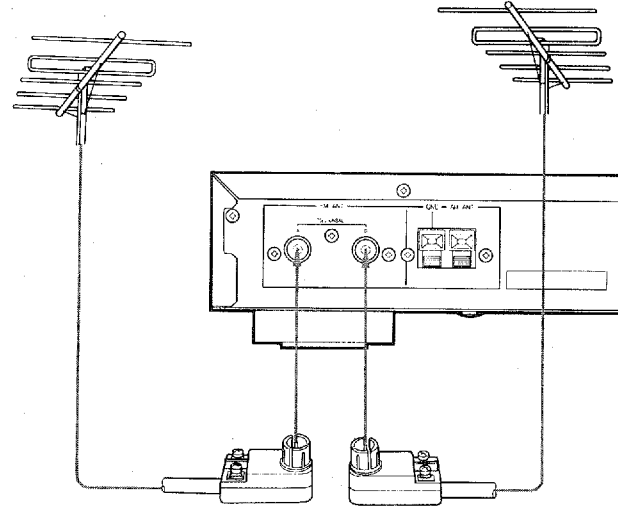

● **300-ohm feeder cable connection**

Connect the 300-ohm feeder cable to the terminals of the included 75-ohm/300-ohm antenna adapter(s), and then insert into the A and/or B 75Ω UNBAL FM ANT terminal(s).

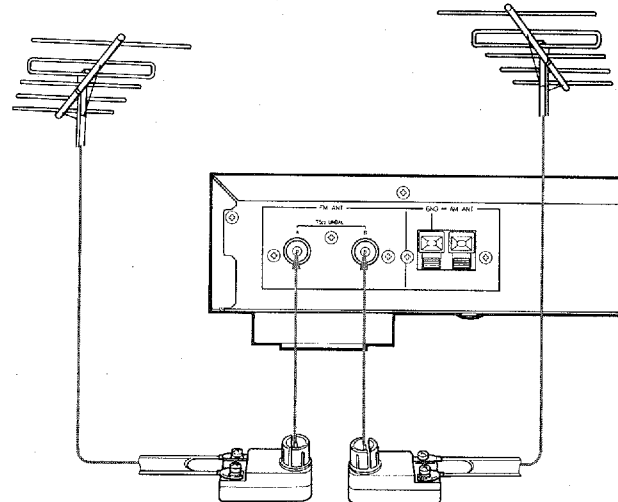

FRONT PANEL COMPONENTS AND THEIR FUNCTIONS

(See Fig. 2)

① POWER switch

Press this switch to switch the power ON. Press it again to switch the power OFF.

② Preset station buttons

The preset station buttons are used to enter as many as 24 station frequencies, including reception modes, into the memory.

③ P1-8/P9-16/P17-24 button

Press this button to change the range of the preset station buttons. When this button is pressed, the selected range indicator (P1-P8, P9-P16, or P17-P24) flashes for about 5 seconds, and then illuminates.

④ Display window

① Preset station indicator

This indicator illuminates to indicate the pressed preset station button.

② Station frequency display

Displays the band and frequency of the received station.

③ IF MODE AUTO/NARROW/WIDE indicator

AUTO:

When the automatic IF mode is selected by pressing the IF MODE AUTO/MAN'L button, this indicator illuminates.

NARROW/WIDE:

In the manual IF mode, when the tuning mode is selected by pressing the IF MODE NARROW/WIDE button, the corresponding indicator illuminates.

④ Signal-quality indicators

Signal-quality meter:

This meter indicates the level of the received frequency.

If multipath interference is detected, the signal-quality level indication decreases.

CSL (Computer Servo Lock):

This indicator illuminates when the Computer Servo Lock (CSL) system is activated during the FM reception mode. For details, refer to "Technical notes on the Computer Servo Lock (CSL) system" on a subsequent page.

FINE TUNING:

This indicator illuminates when the FINE TUNING button is pressed.

FM STEREO:

This indicator illuminates when an FM stereo broadcast with sufficient signal strength is received.

⑤ P1-P8/P9-P16/P17-P24 indicators

These indicators show the range of the preset station buttons.

⑥ MEMORY indicator

When the MEMORY button is pressed, this indicator flashes for about 5 seconds. During this period, the displayed frequency can be programmed to the memory by using one of the preset buttons.

⑦ AUTO ST indicator

This indicator illuminates when the MODE AUTO/MAN'L button is set to AUTO and the MODE FM/MONO button is set to FM to receive an FM broadcast with a sufficiently strong signal.

⑧ BLEND indicator

This indicator shows that the BLEND tuning mode has been activated by using the BLEND button.

⑨ RF ATT indicator

This indicator shows that the RF ATT tuning mode has been activated by using the RF ATT button.

⑩ ANT A/B indicator

This indicator shows the antenna terminal (on the rear panel) that has been selected by using the ANTENNA A/B button.

⑪ AUTO TUNING indicator

This indicator shows that the AUTO TUNING mode has been selected by using the TUNING MODE AUTO/MAN'L button.

⑫ LOCK indicator

This indicator shows that the LOCK function is activated so as to lock-in the desired frequency.

⑤ TUNING control

Tune to the desired station by turning this control. This control is also used to select letters and/or numerals to be used as the name of a preset station.

⑥ Remote control sensor

This sensor receives the signal from the remote-control transmitter (a separate purchase) or a YAMAHA transmitter that bears the  mark.

⑦ FM/AM button

Press this button to select the reception band: FM or AM. The STATION FREQUENCY display will change according to this button's setting.

⑧ MEMORY button

When this button is pressed, the MEMORY indicator flashes for about 5 seconds. During this period, press the desired preset station button to enter the displayed frequency into the memory.

This button is also used to enter the station name into the memory.

⑨ STATION DISPLAY buttons

ON/OFF:

Press this button to edit the name of a received frequency. The STATION FREQUENCY display will disappear, and "----" will appear. This display shows that the unit is in the edit mode.

SHIFT:

Press this button to enter into the memory the letters and/or numerals that were selected by using the TUNING control.

⑩ MODE AUTO ST/MONO button

To receive an FM stereo broadcast of sufficient signal strength in the stereo mode, set the TUNING MODE AUTO/MAN'L button to AUTO and this button to AUTO ST, so that the AUTO ST indicator illuminates.

To receive a weak FM broadcast, set the TUNING MODE AUTO/MAN'L button to MAN'L and this button to MONO, so that the AUTO ST indicator switches OFF. The received broadcast will be heard in the monaural mode.

⑪ BLEND button

If this button is set to the ON position, and the signal-to-noise ratio of a stereo signal is less than about 50 dB, the left and right channels are blended accordingly. When the MODE AUTO ST/MONO button is set to the MONO position, the BLEND function will not operate even if this button is set to the ON position.

⑫ IF MODE buttons

These buttons are used to vary the bandpass width of the FM intermediate frequency between WIDE and NARROW.

AUTO/MAN'L:

This button is used to select the automatic or manual IF tuning mode. When the automatic IF tuning mode is selected, the AUTO indicator illuminates and the tuner automatically selects the IF bandpass width (WIDE or NARROW).

To select the IF bandpass width yourself (manual IF tuning mode), press this button so that the AUTO indicator switches OFF, and then select the IF bandpass width by pressing the NARROW/WIDE button.

NARROW/WIDE:

Press this button to select the IF bandpass width in the manual IF tuning mode. Before pressing this button, be sure to press the AUTO/MAN'L button so that the AUTO indicator switches OFF.

If the reception signal is strong, press this button so that the WIDE indicator illuminates (to obtain distortion-free sound). When the reception signal is weak, or when the desired station is interfered with by adjacent stations, press this button so that the NARROW indicator illuminates (to increase the selectivity).

⑬ RF ATT button

This button is used to reduce RF cross-modulation and intermodulation. In addition, it can be used, together with the IF MODE button, to improve the reception signal condition.

If the reception signal is strong, press this button to ON, so that the RF ATT indicator illuminates. In this position, RF cross-modulation and intermodulation will be reduced.

To receive a distant FM broadcast, press this button to OFF, so that the RF ATT indicator switches OFF (to obtain a better signal-to-noise ratio).

14 ANTENNA A/B button

This button is used to select the antenna terminal (on the rear panel). The ANT A or B indicator illuminates to indicate the activated antenna terminal.

15 TUNING MODE buttons

AUTO/MAN'L:

This button is used to select the tuning mode: automatic or manual. For the automatic tuning mode, press this button so that the AUTO TUNING indicator illuminates. For the manual tuning mode, press this button so that the AUTO TUNING indicator switches OFF.

FINE:

Press this button to precisely tune the station by manual tuning. When this button is pressed, the displayed frequency changes by 0.01 MHz for FM, and 1 kHz for the AM band.

16 LOCK button

This button is used to lock-in the frequency of the broadcast, so that drift-free FM reception is possible.

ON:

Setting this button to ON locks-in the desired frequency, even if there are changes in the temperature and/or humidity. This function is particularly useful when making a long FM broadcast recording.

* The preset stations can be received by using the preset station buttons even if the LOCK button is set to ON.

OFF:

Set this button to OFF when receiving a weak FM broadcast, especially when there is an adjacent strong station interfering with the desired station.

Technical notes on the Computer Servo Lock (CSL) system

The new Yamaha Computer Servo Lock Tuning system eliminates many conventional tuning problems by effectively providing two different tuning modes, each optimized for different types of reception conditions, and both controlled by a sophisticated microprocessor. The microprocessor discriminates between different reception conditions and selects the appropriate tuning mode according to the quality of the received signal.

If the station has a strong, high-quality signal, an infinite-resolution FM stereo tuning circuit is used for maximum audio quality. For a weak, poor-quality signal, the PLL tuning mode locks onto the broadcast frequency so as to assure the best possible reception.

REMOTE-CONTROL TRANSMITTER (a separate purchase)

OPERATION KEYS

① PRESET P1-8/P9-16/P17-24 key

Press this key to select the preset station range.

② Preset station keys

Press one of these keys to select a preset station. To do so, first select the preset station range, and then press the corresponding key to receive the desired station.

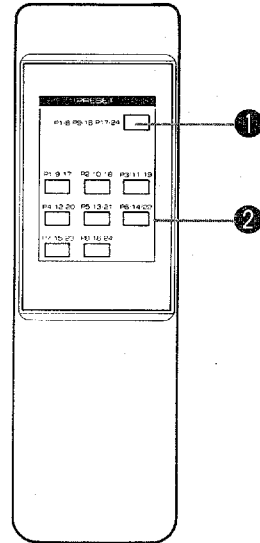

BATTERY INSTALLATION

The remote-control unit uses 2 batteries (size "AA", R06). Install them according to the illustration. Be sure that they are installed correctly.

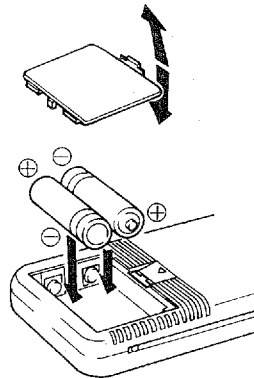

BATTERY REPLACEMENT

When the remote-control operating distance becomes short, the batteries are weak. Replace the two batteries with new ones.

Battery cautions

Incorrect use of the batteries may cause leakage or rupture. Be careful of the following points:

When replacing:

- Replace only with "AA" (R06) batteries.
- Place the batteries for the correct (+) and (-) polarities, as indicated in the battery compartment.
- Do not use an old battery with a new one.
- Do not use different kinds of batteries (alkaline, heavy duty, manganese, Ni-Cad, etc.) at the same time.

Care of the remote-control transmitter:

- If the remote-control transmitter will not be used for an extended period of time, remove the batteries.
- Replace weak batteries as soon as possible.

To prevent accidents:

- Never disassemble, heat, or throw a battery into a fire. Dispose of batteries in specified places.
- Never connect (short-circuit) the (+) and (-) terminals directly with metal, wire, etc.
- There are two kinds of batteries on the market: rechargeable and non-rechargeable. Carefully read all caution labels on batteries.

If leakage occurs:

Wipe away the electrolyte in the battery compartment completely before installing new batteries.

OPERATION RANGE

The remote-control unit should be faced toward the amplifier and be within 7 meters (23 feet), and within 30 degrees to the left or right of the amplifier for proper operation.

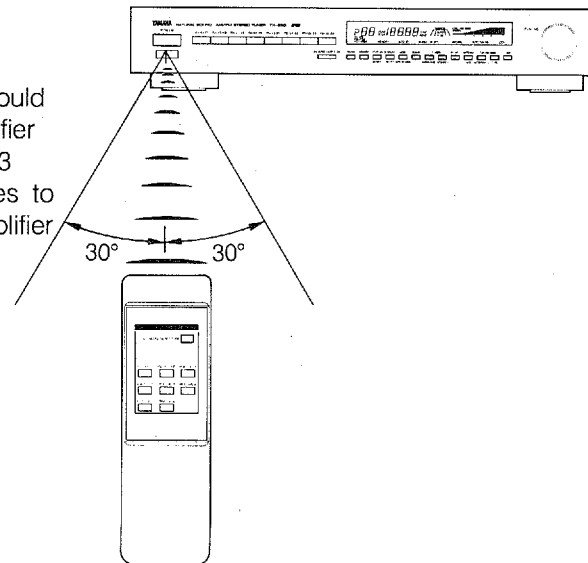

OPERATION

There are three ways to tune to a broadcast station, and you should select the best method according to the signal strength or your own preference.

AUTOMATIC TUNING: This tuning method can be used to find and receive a station of sufficient signal strength.

MANUAL TUNING: This tuning method can be used to tune to a weak station.

PRESET TUNING: This tuning method can be used to tune to a preset station by single-touch tuning.

AUTOMATIC TUNING

If station signals are strong and there is no interference, quick automatic-search tuning is possible.

1. Select the reception band by using the FM/AM button.
2. If two FM outdoor antennas are connected, select either the A or B antenna terminal by using the ANTENNA A/B button.
3. Press the TUNING MODE AUTO/MAN'L button so that the AUTO TUNING indicator illuminates.
4. For FM reception, set the MODE, BLEND, IF MODE and RF ATT buttons as desired.
5. Use the TUNING control to tune to a station. To tune to a higher frequency, slightly turn the control to the right. To tune to a lower frequency, slightly turn the control to the left. Tuning will start automatically, and will stop at a broadcast station frequency of sufficient signal strength.
 - * Be sure to set the LOCK button to OFF. Otherwise, the TUNING control will not function.
6. If the station where tuning stops is not the one you want, slightly turn the control in the desired direction.

MANUAL TUNING

Automatic tuning may be impossible if the station signal is weak. If so, use manual tuning.

1. Select the reception band by using the FM/AM button.
2. If two FM outdoor antennas are connected, select either the A or B antenna terminal by using the ANTENNA A/B button.
3. Press the TUNING MODE AUTO/MAN'L button so that the AUTO TUNING indicator switches OFF.
4. For FM reception, set the MODE, BLEND, IF MODE and RF ATT buttons as desired.
5. Use the TUNING control to tune to a station.
 - To tune to a higher frequency, turn the control clockwise.
 - To tune to a lower frequency, turn the control counterclockwise.
 - Release it just before reaching the desired frequency, and then turn it slowly until the desired frequency is tuned.
 - * Be sure to set the LOCK button to OFF. Otherwise, the TUNING control will not function.

FINE TUNING

Rapid tuning is usually possible with the automatic or manual tuning method, but more stabilized reception is possible by fine tuning under the following conditions:

- To receive a weak or very badly fading broadcast signal from among many signals
- To receive a weak or medium-strength signal which is near a strong signal
- If "beat" noise is received

Under these conditions, manual tuning and then fine tuning can be used to reduce noise and distortion.

Set the TUNING MODE AUTO/MAN'L button to MAN'L, and then press the TUNING MODE FINE button so that the FINE TUNING indicator illuminates.

The best reception can be easily obtained by using the signal-quality meter during fine tuning.

PRESET TUNING

The preset station buttons can be used to select, with a single touch, any desired station which has been preset.

1. Tune to the desired station by using automatic or manual tuning.
 2. Select the range of the preset station buttons by using the P1-8/P9-16/P17-24 button.
 3. Press the MEMORY button and then, while the MEMORY indicator is flashing, press the desired preset station button.
 4. Follow the same procedures for the other preset station buttons.
 5. To recall a preset station, first select the range of the preset station button by using the P1-8/P9-16/P17-24 button, and then press the desired preset station button.
- A new setting can be programmed in place of the former one.
 - For FM reception, the settings of the MODE, BLEND, IF MODE, RF ATT, ANTENNA, and TUNING MODE FINE buttons and the station names are stored along with the station frequency.
 - This unit automatically remembers the most recently tuned station when the power is switched OFF. When the power is switched ON again, the same station will be received.

“Naming” frequencies to be preset

You can preset a station by name instead of by frequency. (The letters and/or numerals (as many as 4) of the name can be selected at will). By using a station name, you can easily find a certain station even if you are not sure of that station's frequency.

1. Tune to the station to be memorized by using either automatic or manual tuning.
2. Press the STATION DISPLAY ON/OFF button.
The STATION FREQUENCY display will indicate “----”.
3. Press the STATION DISPLAY SHIFT button.
The STATION FREQUENCY display will indicate “A---”.
4. Turn the TUNING control to select the first letter or numeral to be memorized.
By turning the TUNING control clockwise, the display will indicate “A, B, C --- Z, 1, 2, 3 --- 9, 0, M and - -” in sequence.
5. When the desired letter or numeral appears, press the DISPLAY SHIFT button to enter it to the memory. The flashing first letter or numeral will illuminate steadily, and the second letter or numeral position will start to flash.
6. Repeat steps 4 and 5 for the other letters and/or numerals, if necessary.
7. Select the range of the preset station buttons by using the P1-8/P9-16/P17-24 button.
8. Press the MEMORY button and then, while the MEMORY indicator is flashing, press the desired preset station button.

When one of these preset stations is recalled, the station name will appear instead of the station frequency.

Memory back-up

The memory back-up circuit prevents the programmed data from being lost even if the power is switched OFF (for timer use or due to temporary power failure). If, however, the unit is not used for a long time, the memory may be erased. If so, it can be re-programmed by simply following the PRESET TUNING steps.

TROUBLESHOOTING

When your unit fails to function properly, before assuming it is faulty, check it according to the following troubleshooting list. It details the corrective action you can take yourself without having to call a service engineer. If you have any doubts or questions, get in touch with your nearest YAMAHA dealer.

	SYMPTOM	CAUSE	REMEDY
FM	Crackling sounds from time to time (especially in weak signal areas).	● Ignition noise from passing vehicles.	● The FM antenna should be put up as high as possible, away from the road, and a coaxial cable used.
		● Noise from thermostats or other electrical equipment.	● Attach a noise suppressor to the equipment causing the noise.
	FM stereo reception is noisy.	● Because of the characteristics of FM stereo broadcasts, this is limited to cases where the transmitter is far away or the antenna input is poor.	● Check the antenna connections. ● Try using a multiple element FM antenna. ● Set the TUNING MODE button to MAN'L mode.
	The FM STEREO indicator flickers and reception is noisy.	● Insufficient antenna input.	● Use an antenna appropriate for the reception condition in your area.
		● Not tuned correctly.	● Tune again.
	There is distortion and clear reception cannot be obtained even with a good FM antenna.	● There is multi-path interference.	● Adjust antenna placement to eliminate multi-path interference.
	No stereo effect even with a stereo broadcast.	● The TUNING MODE button is set to MAN'L.	● Set the button properly.
	A desired station cannot be tuned in with Automatic tuning.	● The station is too weak.	● Use Manual tuning mode. ● Set the IF MODE correctly ● Use a high quality directional FM antenna.
Previously preset stations can no longer be tuned in.	● The tuner has been unplugged for a long period.	● Repeat the presetting procedure.	
AM	Insufficient sensitivity.	● Weak signal or loose antenna connections.	● Tighten the AM loop antenna connections and rotate it for best reception.
	A desired station cannot be tuned in with Automatic tuning.		● Use Manual tuning mode.
	There are continuous crackling and hissing noises.	● These noises result from lightning, fluorescent lamps, motors, thermostats and other electrical equipment.	● Use an outdoor antenna and a ground wire. This will help some what but it is difficult to eliminate all noise.
	There are buzzing and whining noises (especially in the evening).	● Another station is interfering with the received station.	● This is impossible to remedy.
● A television set is being used nearby.		● Move the television away.	

SPECIFICATIONS

FM SECTION

Tuning Range:	87.5 to 108 MHz
50 dB Quieting Sensitivity (IHF):	
75 ohms Mono	1.55 μ V (15.1 dBf)
Stereo (NARROW)	21 μ V (37.7 dBf)
Usable Sensitivity	
Except Europe model	
75 ohms, 1 kHz, 100% mod. (30 dB Quieting)	0.8 μ V (9.3 dBf)
Europe model	
DIN Mono (S/N 26 dB)	0.8 μ V
DIN Stereo (S/N 46 dB)	22 μ V
Image Response Ratio:	90 dB
IF Response Ratio:	110 dB
Spurious Response Ratio:	110 dB
AM Suppression Ratio:	70 dB
Capture Ratio	1.2 dB
Alternate Channel Selectivity:	
Except Europe model	85 dB
Selectivity (two signals, 40 kHz Dev, \pm 300 kHz)	
Europe model	70 dB
Signal-to-Noise Ratio:	
Except Europe model (IHF)	
Mono	96 dB
Stereo	90 dB
Europe model (DIN-NOISE RMS)	
Mono (40 kHz Dev.)	84 dB
Stereo (40 kHz Dev.)	78 dB
Distortion:	
Mono	1 kHz 0.02 %
Stereo	1 kHz 0.03 %
Stereo Separation:	1 kHz 60 dB
Frequency response:	
20 Hz to 15 kHz	0 \pm 0.5 dB

AM SECTION

Tuning Range:	
U.S.A., Canada and General models	520 to 1,720 kHz
U.K., Australia and Europe models	522 to 1,620 kHz
Usable Sensitivity:	100 μ V/m
Selectivity:	32 dB
Signal-to-Noise Ratio:	52 dB
Image Response Ratio:	40 dB
Spurious Response Ratio:	50 dB
Harmonic Distortion; 400Hz	0.3 %

AUDIO SECTION

Output Level/Impedance:	
FM (100 % mod. 1 kHz)	
Except Europe model	500 mV/2 k-ohms
Europe model	400 mV/2 k-ohms
AM (30% mod. 400 Hz)	150 mV/2 k-ohms

GENERAL

Power Supply:	
U.S.A. and Canada models:	120 V, 60 Hz
Europe model:	220 V, 50 Hz
U.K. and Australia models:	240 V, 50 Hz
General model:	110-120 / 220-240 V, 50/60 Hz
Power Consumption:	10 W
Dimensions (W x H x D):	435 x 76 x 320 mm (17-1/8" x 3" x 12-5/8")
Weight:	3.4 kg (7 lbs. 8 oz.)

Specifications subject to change without notice.

YAMAHA

YAMAHA ELECTRONICS CORPORATION, USA 6722 ORANGETHORPE AVE., BUENA PARK, CALIF. 90620, U.S.A.
YAMAHA CANADA MUSIC LTD. 135 MILNER AVE., SCARBOROUGH, ONTARIO M1S 3R1, CANADA
YAMAHA ELECTRONIK EUROPA G.m.b.H. 2084 RELLINGEN, BEI HAMBURG, SIEMENSSTR. 22/34, F.R. OF GERMANY
YAMAHA ELECTRONIQUE FRANCE S.A. 17 RUE DES CAMPANULES, LOGNES 77321 MARNE LA VALLEE CEDEX 2, FRANCE
YAMAHA ELECTRONICS (UK) LTD. YAMAHA HOUSE, 200 RICKMANSWORTH ROAD WATFORD, HERTS WD1 7JS, ENGLAND
YAMAHA SCANDINAVIA A.B. J A WETTERGRENS GATA 1, BOX 30053, 400 43 VÄSTRA FRÖLUNDA, SWEDEN
YAMAHA MUSIC AUSTRALIA PTY, LTD. 17-33 MARKET ST., SOUTH MELBOURNE, 3205 VIC., AUSTRALIA

YAMAHA CORPORATION
10-1 NAKAZAWA-CHO, HAMAMATSU, JAPAN
VI02590-0 BWgW,W ③ ④ Printed in Japan