

DIGITAL WORKSTATION
Tyros2



Owner's Manual



SPECIAL MESSAGE SECTION

PRODUCT SAFETY MARKINGS: Yamaha electronic products may have either labels similar to the graphics shown below or molded/stamped facsimiles of these graphics on the enclosure. The explanation of these graphics appears on this page. Please observe all cautions indicated on this page and those indicated in the safety instruction section.

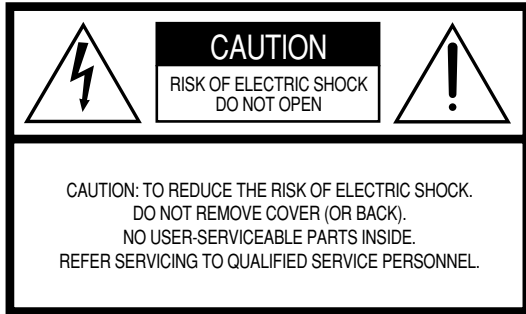

See bottom of Keyboard enclosure for graphic symbol markings.



The exclamation point within the equilateral triangle is intended to alert the user to the presence of important operating and maintenance (servicing) instructions in the literature accompanying the product.

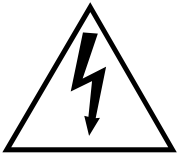

The lightning flash with arrowhead symbol, within the equilateral triangle, is intended to alert the user to the presence of uninsulated “dangerous voltage” within the product’s enclosure that may be of sufficient magnitude to constitute a risk of electrical shock.

IMPORTANT NOTICE: All Yamaha electronic products are tested and approved by an independent safety testing laboratory in order that you may be sure that when it is properly installed and used in its normal and customary manner, all foreseeable risks have been eliminated. **DO NOT** modify this unit or commission others to do so unless specifically authorized by Yamaha. Product performance and/or safety standards may be diminished. Claims filed under the expressed warranty may be denied if the unit is/has been modified. Implied warranties may also be affected.

SPECIFICATIONS SUBJECT TO CHANGE: The information contained in this manual is believed to be correct at the time of printing. However, Yamaha reserves the right to change or modify any of the specifications without notice or obligation to update existing units.

92-469- ① (bottom)

ENVIRONMENTAL ISSUES: Yamaha strives to produce products that are both user safe and environmentally friendly. We sincerely believe that our products and the production methods used to produce them, meet these goals. In keeping with both the letter and the spirit of the law, we want you to be aware of the following:

Battery Notice: This product MAY contain a small non-rechargeable battery which (if applicable) is soldered in place. The average life span of this type of battery is approximately five years. When replacement becomes necessary, contact a qualified service representative to perform the replacement.

Warning: Do not attempt to recharge, disassemble, or incinerate this type of battery. Keep all batteries away from children. Dispose of used batteries promptly and as regulated by applicable laws. Note: In some areas, the servicer is required by law to return the defective parts. However, you do have the option of having the servicer dispose of these parts for you.

Disposal Notice: Should this product become damaged beyond repair, or for some reason its useful life is considered to be at an end, please observe all local, state, and federal regulations that relate to the disposal of products that contain lead, batteries, plastics, etc.

NOTICE: Service charges incurred due to lack of knowledge relating to how a function or effect works (when the unit is operating as designed) are not covered by the manufacturer’s warranty, and are therefore the owners responsibility. Please study this manual carefully and consult your dealer before requesting service.

NAME PLATE LOCATION: The graphic below indicates the location of the name plate. The model number, serial number, power requirements, etc., are located on this plate. You should record the model number, serial number, and the date of purchase in the spaces provided below and retain this manual as a permanent record of your purchase.

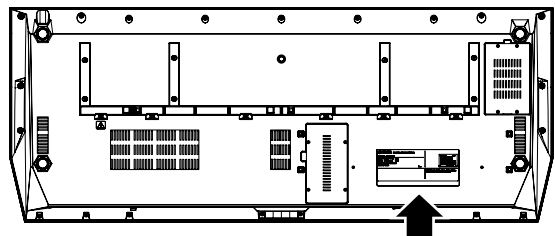

Model _____

Serial No. _____

Purchase Date _____

IMPORTANT SAFETY INSTRUCTIONS

INFORMATION RELATING TO PERSONAL INJURY, ELECTRICAL SHOCK, AND FIRE HAZARD POSSIBILITIES HAS BEEN INCLUDED IN THIS LIST.

WARNING- When using any electrical or electronic product, basic precautions should always be followed. These precautions include, but are not limited to, the following:

- 1.** Read all Safety Instructions, Installation Instructions, Special Message Section items, and any Assembly Instructions found in this manual **BEFORE** making any connections, including connection to the main supply.
- 2.** **Main Power Supply Verification:** Yamaha products are manufactured specifically for the supply voltage in the area where they are to be sold. If you should move, or if any doubt exists about the supply voltage in your area, please contact your dealer for supply voltage verification and (if applicable) instructions. The required supply voltage is printed on the name plate. For name plate location, please refer to the graphic found in the Special Message Section of this manual.
- 3.** This product may be equipped with a polarized plug (one blade wider than the other). If you are unable to insert the plug into the outlet, turn the plug over and try again. If the problem persists, contact an electrician to have the obsolete outlet replaced. Do **NOT** defeat the safety purpose of the plug.
- 4.** Some electronic products utilize external power supplies or adapters. Do **NOT** connect this type of product to any power supply or adapter other than one described in the owners manual, on the name plate, or specifically recommended by Yamaha.
- 5.** **WARNING:** Do not place this product or any other objects on the power cord or place it in a position where anyone could walk on, trip over, or roll anything over power or connecting cords of any kind. The use of an extension cord is not recommended! If you must use an extension cord, the minimum wire size for a 25' cord (or less) is 18 AWG. **NOTE:** The smaller the AWG number, the larger the current handling capacity. For longer extension cords, consult a local electrician.
- 6.** **Ventilation:** Electronic products, unless specifically designed for enclosed installations, should be placed in locations that do not interfere with proper ventilation. If instructions for enclosed installations are not provided, it must be assumed that unobstructed ventilation is required.
- 7.** **Temperature considerations:** Electronic products should be installed in locations that do not significantly contribute to their operating temperature. Placement of this product close to heat sources such as; radiators, heat registers and other devices that produce heat should be avoided.
- 8.** This product was **NOT** designed for use in wet/damp locations and should not be used near water or exposed to rain. Examples of wet/damp locations are; near a swimming pool, spa, tub, sink, or wet basement.
- 9.** This product should be used only with the components supplied or; a cart, rack, or stand that is recommended by the manufacturer. If a cart, rack, or stand is used, please observe all safety markings and instructions that accompany the accessory product.
- 10.** The power supply cord (plug) should be disconnected from the outlet when electronic products are to be left unused for extended periods of time. Cords should also be disconnected when there is a high probability of lightning and/or electrical storm activity.
- 11.** Care should be taken that objects do not fall and liquids are not spilled into the enclosure through any openings that may exist.
- 12.** Electrical/electronic products should be serviced by a qualified service person when:
 - a. The power supply cord has been damaged; or
 - b. Objects have fallen, been inserted, or liquids have been spilled into the enclosure through openings; or
 - c. The product has been exposed to rain; or
 - d. The product does not operate, exhibits a marked change in performance; or
 - e. The product has been dropped, or the enclosure of the product has been damaged.
- 13.** Do not attempt to service this product beyond that described in the user-maintenance instructions. All other servicing should be referred to qualified service personnel.
- 14.** This product, either alone or in combination with an amplifier and headphones or speaker/s, may be capable of producing sound levels that could cause permanent hearing loss. **DO NOT** operate for a long period of time at a high volume level or at a level that is uncomfortable. If you experience any hearing loss or ringing in the ears, you should consult an audiologist. **IMPORTANT:** The louder the sound, the shorter the time period before damage occurs.
- 15.** Some Yamaha products may have benches and/or accessory mounting fixtures that are either supplied as a part of the product or as optional accessories. Some of these items are designed to be dealer assembled or installed. Please make sure that benches are stable and any optional fixtures (where applicable) are well secured **BEFORE** using. Benches supplied by Yamaha are designed for seating only. No other uses are recommended.

PLEASE KEEP THIS MANUAL

PRECAUTIONS

PLEASE READ CAREFULLY BEFORE PROCEEDING

* Please keep this manual in a safe place for future reference.

WARNING

Always follow the basic precautions listed below to avoid the possibility of serious injury or even death from electrical shock, short-circuiting, damages, fire or other hazards. These precautions include, but are not limited to, the following:

Power supply/Power cord

- Only use the voltage specified as correct for the instrument. The required voltage is printed on the name plate of the instrument.
- Check the electric plug periodically and remove any dirt or dust which may have accumulated on it.
- Use only the supplied power cord/plug.
- Do not place the power cord near heat sources such as heaters or radiators, and do not excessively bend or otherwise damage the cord, place heavy objects on it, or place it in a position where anyone could walk on, trip over, or roll anything over it.

Do not open

- This instrument contains no user-serviceable parts. Do not attempt to disassemble or modify the internal components in any way.

Water warning

- Do not expose the instrument to rain, use it near water or in damp or wet conditions, or place containers on it containing liquids which might spill into any openings.
- Never insert or remove an electric plug with wet hands.

Fire warning

- Do not put burning items, such as candles, on the unit.
A burning item may fall over and cause a fire.

If you notice any abnormality

- If the power cord or plug becomes frayed or damaged, or if there is a sudden loss of sound during use of the instrument, or if any unusual smells or smoke should appear to be caused by it, immediately turn off the power switch, disconnect the electric plug from the outlet, and have the instrument inspected by qualified Yamaha service personnel.

CAUTION

Always follow the basic precautions listed below to avoid the possibility of physical injury to you or others, or damage to the instrument or other property. These precautions include, but are not limited to, the following:

Power supply/Power cord

- When removing the electric plug from the instrument or an outlet, always hold the plug itself and not the cord. Pulling by the cord can damage it.
- Remove the electric plug from the outlet when the instrument is not to be used for extended periods of time, or during electrical storms.
- Do not connect the instrument to an electrical outlet using a multiple-connector. Doing so can result in lower sound quality, or possibly cause overheating in the outlet.

Location

- Do not expose the instrument to excessive dust or vibrations, or extreme cold or heat (such as in direct sunlight, near a heater, or in a car during the day) to prevent the possibility of panel disfiguration or damage to the internal components.

- Do not use the instrument in the vicinity of a TV, radio, stereo equipment, mobile phone, or other electric devices. Otherwise, the instrument, TV, or radio may generate noise.
- Do not place the instrument in an unstable position where it might accidentally fall over.
- Before moving the instrument, remove all connected cables.
- When setting up the instrument, make sure that the AC outlet you are using is easily accessible. If some trouble or malfunction occurs, immediately turn off the power switch and disconnect the plug from the outlet.
- Use only the stand specified for the instrument. When attaching the stand or rack, use the provided screws only. Failure to do so could cause damage to the internal components or result in the instrument falling over.
- Do not place objects in front of the instrument's air vent, since this may prevent adequate ventilation of the internal components, and possibly result in the instrument overheating.

Connections

- Before connecting the instrument to other electronic components, turn off the power for all components. Before turning the power on or off for all components, set all volume levels to minimum. Also, be sure to set the volumes of all components at their minimum levels and gradually raise the volume controls while playing the instrument to set the desired listening level.

Maintenance

- When cleaning the instrument, use a soft, dry cloth. Do not use paint thinners, solvents, cleaning fluids, or chemical-impregnated wiping cloths.

Handling caution

- Do not insert a finger or hand in any gaps on the instrument.
- Never insert or drop paper, metallic, or other objects into the gaps on the panel or keyboard. If this happens, turn off the power immediately and unplug the power cord from the AC outlet. Then have the instrument inspected by qualified Yamaha service personnel.
- Do not place vinyl, plastic or rubber objects on the instrument, since this might discolor the panel or keyboard.
- Do not rest your weight on, or place heavy objects on the instrument, and do not use excessive force on the buttons, switches or connectors.
- Do not operate the instrument for a long period of time at a high or uncomfortable volume level, since this can cause permanent hearing loss. If you experience any hearing loss or ringing in the ears, consult a physician.

Saving data

Saving and backing up your data

The data of the types listed below are lost when you turn off the power to the instrument. Save the data to the User drive (page 67) or appropriate external media.

- Recorded/Edited Songs (pages 55, 59, 121, 135)
- Created/Edited Styles (page 159)
- Created/Edited Voices (pages 91, 94)
- Created Multi Pads (page 169)
- Memorized One Touch Settings (page 155)
- Edited MIDI settings (page 214)

Data in the User drive (page 71) may be lost due to malfunction or incorrect operation. Save important data to an external media.

Backing up the USB storage device/external media

- To protect against data loss through media damage, we recommend that you save your important data onto two USB storage devices/external media.

When you change settings in a display page and then exit from that page, System Setup data (listed in the Parameter Chart of the separate Data List booklet) is automatically stored. However, this edited data is lost if you turn off the power without properly exiting from the relevant display.

Caution for data operations

Make sure NEVER to turn the Tyros2's power off during any kind of data operation involving the USER/USB/HD drives—such as saving, deleting, or copying/pasting—until the operation is completely finished. (Make sure to wait until the alert message shown below disappears.) Turning the power off during the operation results in the loss of the data being saved or pasted to the respective drive.

Keeping the power on during such operations is particularly important in regard to the USER drive. Turning off the power while performing a save/delete/paste operation with the USER drive may result in loss of ALL data on the USER drive (upon the next power on)—and not just the data in question. In other words, if you are performing a save/delete/paste operation on only the song data of the USER drive and you turn off the power before the operation is completed, you risk losing ALL your USER drive data—including all voices, styles, Multi Pad banks and Registration Memory presets you've saved to the USER drive.

This caution also applies to creating a new folder on the USER drive or using the factory reset operation (page 196).



Now executing.
(Don't turn off the power now,
otherwise the data may be damaged.)

Yamaha cannot be held responsible for damage caused by improper use or modifications to the instrument, or data that is lost or destroyed.

Always turn the power off when the instrument is not in use.

Copyright Notice

The following is the title, credits, and copyright notices for the song pre-installed in this instrument.

Beauty And The Beast
from Walt Disney's BEAUTY AND THE BEAST
Lyrics by Howard Ashman
Music by Alan Menken
© 1991 Walt Disney Music Company and Wonderland Music
Company, Inc.
All Rights Reserved Used by Permission

Can't Help Falling In Love
from the Paramount Picture BLUE HAWAII
Words and Music by George David Weiss, Hugo Peretti and
Luigi Creatore
Copyright © 1961 by Gladys Music, Inc.
Copyright Renewed and Assigned to Gladys Music
All Rights Administered by Cherry Lane Music Publishing
Company, Inc. and Chrysalis Music
International Copyright Secured All Rights Reserved

A variety of helpful and useful information concerning the Tyros2 is available at the following website:
<http://music.yamaha.com/tyros2>

Congratulations!

You are the proud owner of an extraordinary electronic keyboard. The Yamaha Tyros2 combines the most advanced tone generation technology with state-of-the-art digital electronics and features to give you stunning sound quality with maximum musical versatility. In order to make the most of your Tyros2's features and vast performance potential, we urge you to read the manual thoroughly while trying out the various features described. Keep the manual in a safe place for later reference.

Packing List

- Tyros2
- AC power cord x 1
- Music rest and brackets
- CD-ROM
- Owner's Manual (this book), Data List, Installation Guide
- Screws for installing the optional hard disk drive

■ About the included CD-ROM

The accompanying CD-ROM features special software for use with the Tyros2. Included is a Voice Editor, which gives you comprehensive and intuitive editing tools for the Tyros2. For details, see the separate Installation Guide or the online manuals included with the software.

CAUTION

- *Never attempt to play back the CD-ROM on an audio CD player. Doing so may result in damage to your hearing as well as to your CD player/audio speakers.*

- The photos of the harpsichord, bandoneon, hackbrett, music box, dulcimer and cimbalom, shown in the displays of the Tyros2, are courtesy of the Gakkigaku Shiryokan (Collection for Organology), Kunitachi College of Music.
- The following instruments, shown in the displays of the Tyros2, are on display at the Hamamatsu Museum of Musical Instruments: balafon, gender, kalimba, kanoon, santur, gamelan gong, harp, hand bell, bagpipe, banjo, carillon, mandolin, oud, pan flute, pungi, rabab, shanai, sitar, steel drum, tambra.
- This product is manufactured under license of U.S. Patents No.5231671, No.5301259, No.5428708, and No.5567901 from IVL Technologies Ltd.
- The bitmap fonts used in this instrument have been provided by and are the property of Ricoh Co., Ltd.
- This product utilizes NF, an embedded Internet browser from ACCESS Co., Ltd. NF is used with the patented LZW, licensed from Unisys Co., Ltd. NF may not be separated from this product, nor may it be sold, lent or transferred in any way. Also, NF may not be reverse-engineered, reverse-compiled, reverse-assembled or copied. This software includes a module developed by the Independent JPEG Group.
- Windows is the registered trademarks of Microsoft® Corporation.
- Apple and Macintosh are trademarks of Apple Computer, Inc., registered in the U.S. and other countries.
- The company names and product names in this Owner's Manual are the trademarks or registered trademarks of their respective companies.

ACCESS

The illustrations and LCD screens as shown in this owner's manual are for instructional purposes only, and may appear somewhat different from those on your instrument.

Note that all display examples shown in this manual are in English.

This product incorporates and bundles computer programs and contents in which Yamaha owns copyrights or with respect to which it has license to use others' copyrights. Such copyrighted materials include, without limitation, all computer software, style files, MIDI files, WAVE data, musical scores and sound recordings. Any unauthorized use of such programs and contents outside of personal use is not permitted under relevant laws. Any violation of copyright has legal consequences. **DON'T MAKE, DISTRIBUTE OR USE ILLEGAL COPIES.**

This device is capable of using various types/formats of music data by optimizing them to the proper format music data for use with the device in advance. As a result, this device may not play them back precisely as their producers or composers originally intended.

While certain reproduction and use of copyrighted music and other sound products are permitted under applicable laws, such reproduction and use without license may constitute copyright infringement and other violation of laws. Since violation of such laws can have serious consequences, you may wish to consult a legal expert about your planned use of this product.

Copying or playing back of commercially available music and other sound products is strictly prohibited except for your personal use.

This product can be used to import/record analog audio signals through the MIC/LINE INPUT, and can also record your keyboard performance and playback of MIDI song data into digital audio signals of WAV format. If you use any copyrighted material in your recording—even if you add your own performance—the copying or public playback of that material, other than for your own personal use, is strictly prohibited.

Copying of the commercially available musical data including but not limited to MIDI data and/or audio data is strictly prohibited except for your personal use.

How to use the manual

Starting Up..... page 18

Before going on to any other part of the manual, we strongly suggest you read this section first. It shows you how to get started playing and using your new Tyros2.

Quick Guide..... page 22

Unless you enjoy reading manuals, you're probably eager to start playing your new Tyros2 right now. If so, read this section.

Contents..... page 8

Application Index page 10

This special index is organized by functions and applications—not by single words—allowing you to quickly and easily find how to perform a particular operation or explore a topic of interest.

Panel Controls and Terminals..... page 14

Use this section to find out about all of the buttons and controls of the Tyros2.

Basic Operations..... page 68

Here, we'll show you the basic structure in handling and organizing the data of the Tyros2 in files and the basic operations using the LCD display.

Function Tree..... page 81

This lists all functions of the Tyros2 according to their hierarchical structure, letting you easily see the relationship of the various functions and quickly locate desired information.

Reference page 84

Once you're familiar with everything above, lightly go over this comprehensive guide to all functions. You won't need (or want) to read everything at once, but it is there for you to refer to when you need information about a certain feature or function.

Troubleshooting..... page 225

If the Tyros2 does not function as expected or you have some problem with the sound or operation, refer to this section before calling your Yamaha dealer or service center. Most common problems and their solutions are covered here in a very simple and easy-to-understand way.

Glossary..... page 227

Important words and technical terms not fully explained in the manual are covered here.

Data List (separate)

This contains various important lists such as the Direct Access Chart, Chord Fingering Chart for Style playback, Voice List, Style List, Effect Type List, MIDI Data Format, MIDI Implementation Chart.

Installation Guide (separate)

Included with the Tyros2 are some software programs (on the CD-ROM) that let you use your computer with the Tyros2 for creating voices. Refer to this guide for instructions on installing the included software.

Contents

Congratulations!	6
Packing List	6
How to use the manual	7
Contents	8
Application Index	10
Panel Controls and Terminals	14
Top Panel & Connections	14
Rear Panel & Connections	16

Starting Up 18

Power Supply	18
Optional Speakers	18
Music Rest	19
Turning the Power On/Off	20
Raising and Closing the Display Panel	21

Quick Guide 22

Turning the Power On and Playing the Demos	22
Turning the Power On and Viewing the Main Display	22
Changing the Language	23
Playing the Demos	24
Playing Voices	25
Selecting a Voice (RIGHT 1) and playing the keyboard	25
Playing Two or Three Voices Simultaneously	26
Playing Different Voices with the Left and Right Hands	27
Adjusting the Octave Setting	27
Organ Flutes	28
Collecting your favorite voices to the User drive or external devices	29
Selecting and Playing a Style	
—Auto Accompaniment (ACMP)	31
Playing a melody with your right hand and playing chords with your left hand	31
Pattern Variation (Sections)	34
One Touch Setting	36
Adjusting the Volume Balance between the Style and the Keyboard	36
Turning Style Parts On/Off and Changing Voices	37
The Multi Pads	38
Playing the Multi Pads	38
Using Chord Match	38
Voice Effects	39
Applying Harmony to Your Right-hand Melody	39
Calling Up Ideal Setups for Your Music	
—Music Finder	40
Selecting the desired music genre from the Record List	40
Searching the Ideal Setups by Keyword	41
Creating a Set of Favorite Records	42
Song Playback	43
Playback of Songs in the USB Storage Device	43
Using Song Position Markers	44
Adjusting the Volume Balance between the Song and the Keyboard	46
Turning Song Parts On/Off	46

Singing with a Connected Microphone	47
Connecting a microphone	47
Singing Along with Lyrics	47
Applying harmony to your voice	48
Keyboard and Vocal Practice using the Guide function	49
Selecting a Guide menu	49
Keyboard Practice using “Follow Lights”	50
Vocal Practice using “Vocal Cue Time”	51
Saving and Recalling Custom Panel Setups	
—Registration Memory	52
Saving your Panel Setups to a Registration Memory	52
Saving your Registration Memory to the User drive	53
Recalling a Registration Memory Setup	54
Recording Your Performances and Creating Songs	
—Song Recording	55
Quick Recording	55
Multi Recording	57
Recording Audio to the Tyros2	
—Hard Disk Recorder	59
Recording the Sound of the Tyros2	59
Recording your singing and playing together	62
Connecting to a USB Storage Device	64
Using USB Storage Devices	65
Connecting to a Computer	66
Initial Setup	67
Accessing a hard disk drive via the USB Storage Mode	67

Basic Operations

—Organizing Your Data 68

Display-based Controls	68
Display Messages	69
Direct Access—Instant Selection of Displays	70
Basic Structure of File/Folder and Memory Drives	70
Folder/File Operations using the Open/Save Display	72
Creating a New Folder	73
Selecting (Opening) a Folder/File	73
Copying Folders/Files (Copy & Paste)	74
Moving Files (Cut & Paste)	74
Deleting Folders/Files	75
Saving Files	75
Naming Folders/Files	76
Changing the Open/Save Display View	77
About the Highlight Cursor in the Display	79
About the Panel Button Colors	79
About the Keyboard	80
Keyboard Sections and Their Functions	80
Synchro Start On/Off	80
Function Tree	81

Reference 84

Voices	84
Voices and Keyboard Parts	84
Voice Types	85
Voice Effects	87
Changing Pitch on the Tyros2	88

Organ Flutes (Footage Settings)	89	Custom Style Recording via an External Sequence Recorder.....	167
Parameters.....	89	The Multi Pads	169
Voice Editing (Voice Set)	91	Multi Pad Editing using the Open/Save display.....	169
Parameters.....	91	Multi Pad Creating/Editing (Digital Recording).....	169
Voice Creator—Custom Voice Edit	94	Music Finder	171
Creating a Voice—Basic Procedure.....	94	Music Finder Record Editing.....	171
Editing a Custom Voice on the Tyros2—Voice Set.....	101	Saving Music Finder Records as a single file.....	171
Editing a Custom Voice Bank.....		Registration Memory	173
—Custom Voice Bank Edit.....	102	Freeze.....	173
Loading a single Custom Voice to the Tyros2.....		Registration Sequence.....	173
—Individual Load.....	104	Using a Microphone	175
Loading a Custom Voice Library to the Tyros2.....		Vocal Harmony Edit.....	175
—Library Load.....	106	Talk Setting.....	177
Saving your Custom Voices to a Library.....		Microphone Overall Settings.....	177
—Library Save.....	108	Mixing Console	179
Editing a Custom Voice on your computer.....		Part Settings.....	180
—Voice Editor.....	111	Song Auto Revoice.....	181
Song Playback	112	Effects.....	181
Displaying Music Notation.....	112	Equalizer (EQ).....	184
Displaying Lyrics.....	114	Master Compressor.....	185
Displaying Text.....	115	Line Out Settings.....	185
Displaying the Lyrics/Text on an external monitor.....	116	Making Global and Other Important Settings	
Song Position.....	117	—Function.....	187
Song Playback Related Parameters.....	118	Tuning.....	187
Playing Backing Parts with the performance assistant Technology.....	120	Voice Set.....	188
Song Creator (Digital Recording)	121	Screen Out Settings.....	188
Record Mode Settings (Setting up for Re-recording)....	122	Controller.....	189
Editing Data for each Channel.....	123	Harmony/Echo.....	191
Step Recording for Chord data using the Event List....	125	Other Settings (Utility).....	193
Step Recording for Notes using the Event List.....	127	Connecting the Tyros2 Directly to the Internet	197
Step Recording for System Exclusive Messages using the Event List.....	133	Connecting the Instrument to the Internet.....	197
Step Recording for Lyrics using the Event List.....	133	Accessing the Special Tyros2 Website.....	198
Recording Audio with the Hard Disk Recorder	135	Operations in the Special Tyros2 Website.....	198
Hard Disk File/Folder Operations.....		Purchasing and Downloading Data.....	201
—Open/Save Display.....	135	Saving Bookmarks of Your Favorite Pages.....	202
Importing an Audio File.....	137	Changing the Home Page.....	204
Exporting an Audio File.....	139	About the Internet Settings Display.....	205
Re-recording.....	141	Initializing Internet Settings.....	208
Setting the Start/End points of the audio.....	146	Glossary of Internet Terms.....	209
Playlist mode.....	147	MIDI	210
Creating a Playlist.....	147	MIDI System Settings.....	215
Playing a Playlist.....	149	MIDI Transmit Settings.....	215
Playlist Controls.....	151	MIDI Receive Settings.....	216
Style Playback (Auto Accompaniment)	152	Setting the Chord Root for Style Playback via MIDI receive.....	217
Style Characteristics.....	152	Setting the Chord Type for Style Playback via MIDI receive.....	217
Chord Fingerings.....	152	MFC10 Settings.....	217
Fade In/Out.....	154	Appendix	219
Tempo.....	154	Installing the Optional Speakers	219
Synchro Start and Synchro Stop.....	155	Installing an Optional Hard Disk	221
Programmable One Touch Setting (OTS).....	155	Installing the Optional DIMMs	223
Instant Style Selection.....	156	Troubleshooting	225
Style Playback Related Settings.....	157	Glossary	227
Style Settings.....	157	Specifications	229
Split Point.....	158	Handling the floppy disk drive (FDD) and floppy disks	231
Style Creator (Digital Recording)	159	Index	232
Basic Settings and Realtime Recording for each part (channel).....	161		
Step Recording for Notes using the Event List.....	162		
Assembling a Style from Existing Pattern Data.....	163		
Groove and Dynamics.....	163		
Editing Data for each Channel.....	165		
Making Style File Format Settings.....	165		

Starting up before turning the power on

- Setting up the music rest Page 19
- Connecting headphones Page 14
- Connecting optional speakers Page 219
- Turning the power on/off Pages 20, 22

Listening to the Tyros2

- Playing the Demos Page 24
- Playing songs
 - Playing a song Page 43
 - Turning parts (channels) of the song on/off Page 46
 - Adjusting the balance between the song and keyboard Page 46
- Playing styles
 - Playing Preset styles Page 31
 - Turning parts (channels) of the style on/off Page 37
 - Adjusting the balance between the style and keyboard Page 36
- Playing the Multi Pads Page 38

Playing the Keyboard

- Selecting a Voice (RIGHT 1) and playing the keyboard Page 25
- Playing two or three voices simultaneously Page 26
- Playing different voices with the left and right hands Page 27
- Understanding the four keyboard parts (RIGHT 1, 2, 3, and LEFT) Page 80
- Playing the drum/percussion voices Page 85
- Playing the Super Articulation voices Page 86
- Understanding Initial touch and Aftertouch Pages 87, 191
- Setting the touch sensitivity of the keyboard Page 191
- Turning Initial Touch on or off for each keyboard part (RIGHT 1, 2, 3, LEFT) Page 191
- Turning Aftertouch on or off for each keyboard part (RIGHT 1, 2, 3, LEFT) Page 191
- Setting the Modulation wheel for each keyboard part (RIGHT 1, 2, 3, LEFT) Page 191

Practicing the keyboard performance

- Using the Metronome Page 193
- Displaying and playing along with the music notation of the song during playback.....
 - Song Score Page 112
 - Guide Page 49

Selecting the programs and settings of the Tyros2

- Voices Page 25
- Custom voices Page 94
- Styles Page 31
- Multi Pad banks Page 38
- Songs (MIDI) Page 43
- Songs (audio) Page 59
- Music Finder records Page 40
- Registration Memory banks Page 54
- Registration Memory numbers Page 54
- One Touch Setting numbers Page 36
- Harmony/Echo types Page 191
- MIDI templates Page 213
- Effect types Page 183
- Vocal Harmony types Page 48
- Master EQ types Page 184
- Master Compressor types Page 185

Using the LCD display

- Understanding and using the Main display Page 22
- Viewing the Song Lyrics on the LCD display Page 47, 114
- Viewing the Song Score on the LCD display Pages 51, 112
- Viewing text on the LCD display Page 115
- Showing the display contents on a separate monitor Pages 16, 188

Playing style playback chords with your left hand and melodies with your right—Auto Accompaniment (ACMP) feature

- Selecting and playing a style Page 31
- Learning how to play specific chord types Chord Tutor Page 152
- Learning how to play (indicate) chords for style playback..... Chord Fingering..... Page 152
- Applying automatic harmony or echo to your right-hand melodies..... Harmony/Echo..... Pages 39, 191
- Automatically changing the chords of the Multi Pads
with your left-hand play Chord Match..... Page 38

Instantly selecting custom panel settings

- Calling up ideal panel setups..... Programmable Music Finder Pages 40, 171
- Changing setups to match the style..... Programmable One Touch Setting (OTS) Pages 36, 155
- Saving and recalling custom panel setups Registration Memory Pages 52, 173

Creating sounds, styles, songs, and more

- Data that can be created using the Tyros2's features Page 71
- Creating your original voices Voice Set Page 91
 - Voice Creator..... Page 94
- Creating your original Organ Flutes voices..... Voice Set Page 89
- Creating your original styles Style Creator Page 159
 - Assembling a custom style from existing patterns Page 163
 - Recording a rhythm pattern..... Page 161
 - Memorize panel settings to the One Touch Setting contained in the style Page 155
- Creating your original songs
 - Recording your keyboard performance Song Creator Pages 55–58
 - Inputting notes one by one Song Creator Pages 125–132
 - Inputting and editing lyrics..... Song Creator Page 133
 - Entering Markers in a song Song Creator Pages 44, 133
 - Recording your performance to the optional hard disk drive..... Hard Disk Recorder..... Pages 59, 135
- Creating your original Multi Pads Page 169
- Creating a Registration Memory bank Pages 53–54
- Creating new Music Finder records Page 171
- Creating new Vocal Harmony types Page 175
- Creating new Effect types Page 183
- Creating custom Master EQ settings Page 184
- Creating custom Master Compressor settings..... Page 185
- Naming the created data Page 76
- Saving the created data as a file Page 75

Understanding the organization and structure of the Tyros2

- About the various types of data/files managed with the Tyros2 Page 71
- About files and folders Page 71
- About the color-coded button lamps Page 79
- About the memory structure Page 71
- About basic operations Pages 68–80
- About the tone generator parts Page 179
- About the effect structure..... Page 181

Controlling and adjusting the pitch

- Adjusting the overall pitch of the Tyros2.....Master Tune.....Page 187
- Tuning the individual notes of the keyboard.....Scale Tune.....Page 187
- Adjusting the octave of the keyboard.....Pages 27, 180
- Transposing notes (Master Transpose, Keyboard Transpose, Song Transpose).....Pages 88, 180
- Setting [TRANSCOPE] button to independently control separate parts.....Page 191
- Using the PITCH BEND wheel.....Page 88
- Using the MODULATION wheel.....Page 88

Using foot pedals

- Connecting foot pedals to the Tyros2.....Page 16
- Assigning specific functions to each foot pedal.....Page 189
- Using a foot pedal to change Registration Memory numbers.....Registration Sequence.....Page 173

Singing with a connected microphone

- Connecting a microphone to the Tyros2.....Page 47
- Automatically applying vocal harmonies to your voice.....Vocal Harmony.....Page 48
- Applying effects to your voice.....Page 175
- Singing while following along with the Lyrics on the display.....Pages 47, 114
- Singing while following along with the Lyrics or text on a separate monitor.....Page 116
- Singing with the Guide functions and song playback.....Page 51
- Using the Talk Setting function.....Page 177
- Matching the Song Transpose setting to a comfortable singing pitch.....Page 180
- Matching the Keyboard Transpose setting to a comfortable singing pitch.....Page 180

Live performance tips and techniques

- Assigning specific panel operations/functions for foot control.....Page 189
- Calling up Registration Memory numbers in custom-set order.....Registration Sequence.....Page 173
- Using a foot pedal to change Registration Memory numbers.....Page 173
- Using an optional MFC10 Foot Controller with the Tyros2.....Page 217
- Using the Fade In/Out feature.....Page 154
- Using Song Position Markers to jump within a song and loop sections.....Page 44

Group performance tips and techniques

- Independently transposing the song and keyboard pitch to match your singing range.....Page 180
- Tuning the overall sound of the Tyros2 to match other instruments.....Page 187
- Synchronizing the Tyros2 to other MIDI instruments.....Page 215

Learning about MIDI

- About MIDI note events (playing the keyboard).....Page 210
- About MIDI program changes (selecting voices).....Page 210
- About MIDI events in songs, styles, and Multi Pads.....Page 210

Connecting/Installing external equipment to the Tyros2

- Connecting a set of optional speakers.....Page 219
- Connecting USB storage devicesPage 64
- Installing an optional Hard Disk unit to the Tyros2.....Page 221
- Formatting the optionally installed drives.....Page 194
- Connecting external audio equipment and effect units.....Page 17
- Connecting MIDI instruments and devicesPage 211
- Connecting an optional MFC10 Foot ControllerPage 217
- Connecting a computer via USB.....Page 66
- Connecting a separate monitor.....Page 116

Computer applications

- What you can do with MIDI using a computer and the Tyros2.....Page 66
- Connecting a computer to the Tyros2 using a USB cable.....Page 66
- Using the Voice Editor softwarePage 67, 111
- Using the installed hard disk drive as a drive for your computerPage 67

Other Tips

- Registering your name to the Tyros2.....Page 195
- Importing a favorite picture for the Main display backgroundPage 195
- Importing a favorite picture for the Song Lyrics or text backgroundPage 114
- Importing custom icons for voice/style/song indications in the Open/Save displayPage 76
- Displaying the bank select and program numbers in the Voice Selection screen
(Open/Save display for voices)Page 193
- Specifying style playback chords from an external MIDI instrument.....Page 217

Panel Controls and Terminals

■ Top Panel & Connections

Music Rest

The Tyros2 is supplied with a music rest that can be attached to the instrument as shown. **Page 19**

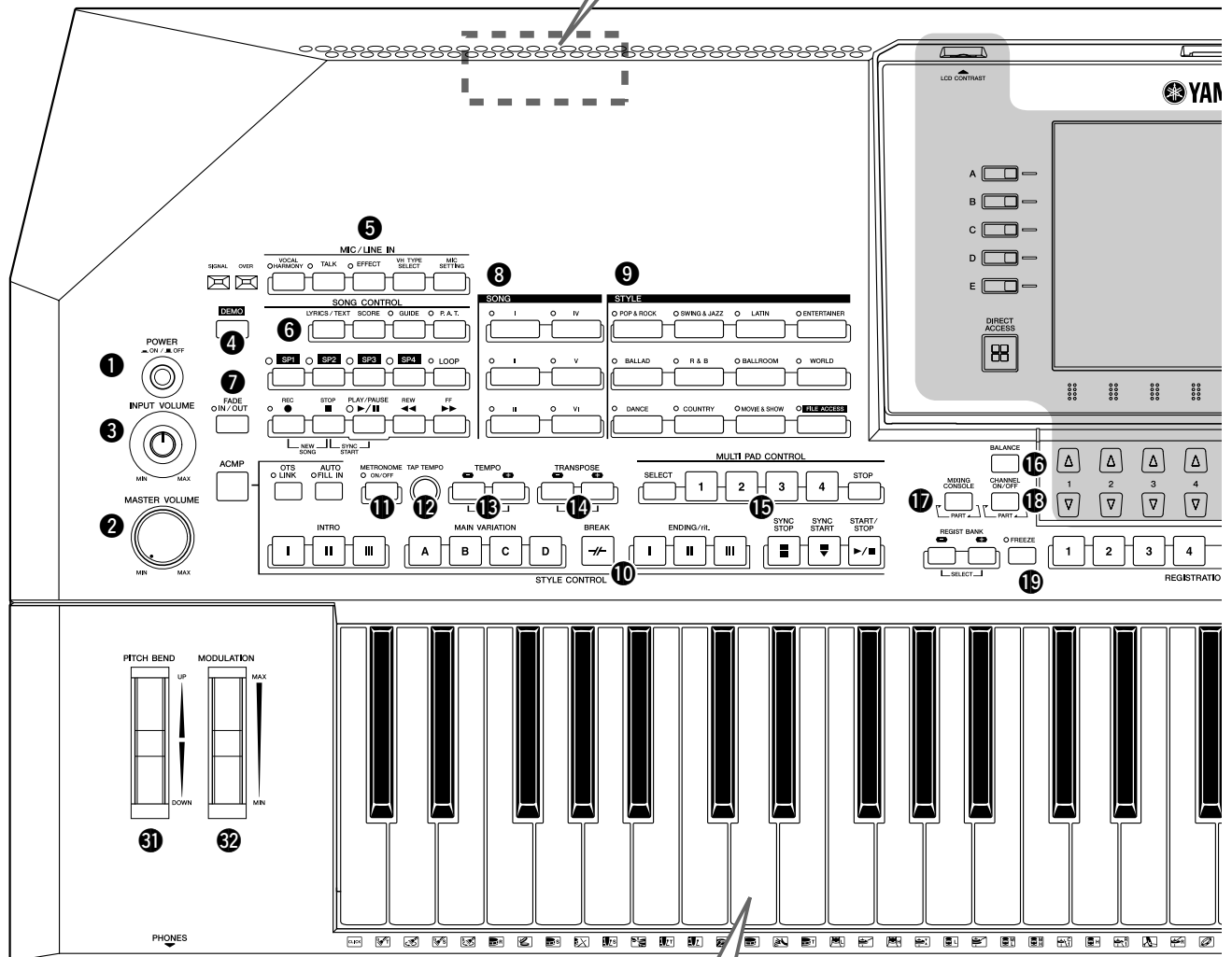
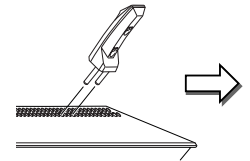

Keyboard

The keyboard of the Tyros2 is equipped with a touch response feature (initial touch and after touch) that lets you dynamically and expressively control the level of the voices with your playing strength—just as on an acoustic instrument. **Page 87**

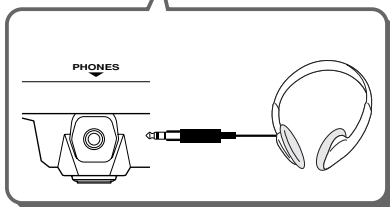

- | | | | |
|-------------------------------|---------------|-----------------------------------|---------------|
| 1 POWER ON/OFF switch..... | Pages 20, 22 | 10 STYLE CONTROL buttons..... | Page 34 |
| 2 MASTER VOLUME control | Page 20 | 11 METRONOME button | Page 193 |
| 3 INPUT VOLUME control | Pages 47, 175 | 12 TAP TEMPO button | Page 154 |
| 4 DEMO button | Page 24 | 13 TEMPO buttons | Page 154 |
| 5 MIC/LINE IN buttons | Pages 175 | 14 TRANSPOSE buttons | Page 88 |
| 6 SONG CONTROL buttons | Page 43 | 15 MULTI PAD CONTROL buttons..... | Pages 38, 169 |
| 7 FADE IN/OUT button | Page 154 | 16 BALANCE button..... | Pages 36, 46 |
| 8 SONG buttons | Pages 43, 78 | 17 MIXING CONSOLE button | Page 179 |
| 9 STYLE buttons..... | Pages 31, 156 | 18 CHANNEL ON/OFF button..... | Pages 37, 46 |

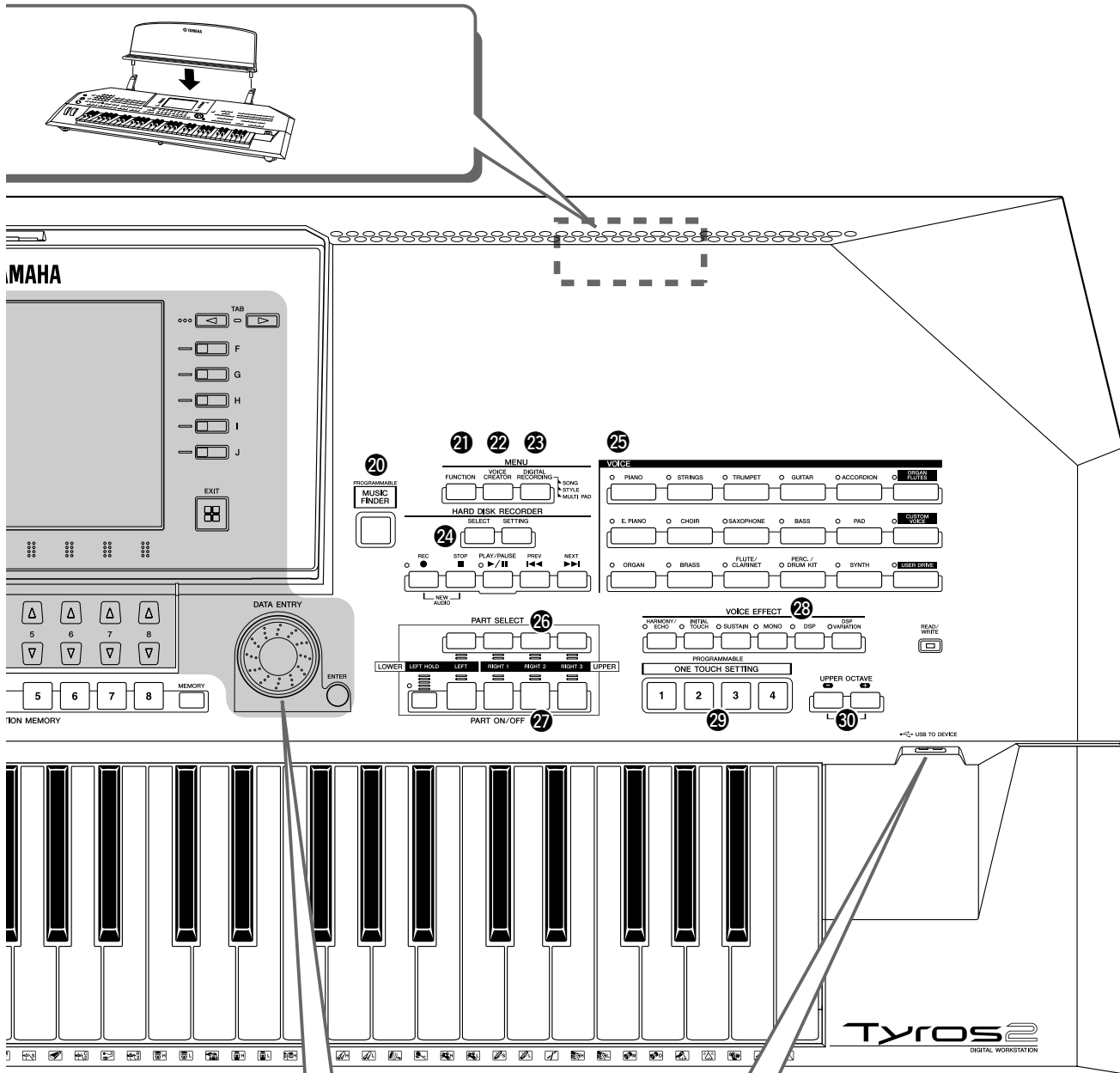

Liquid Crystal Display (LCD) and Related Buttons/Controls

- LCD contrast
- LCD (A-J) buttons
- TAB buttons
- LCD (1-8) up/down buttons
- DIRECT ACCESS button
- EXIT button
- DATA ENTRY dial
- ENTER button

Page 21, 68

USB TO DEVICE terminal

Page 64

By connecting the instrument to a USB storage device, you can save data you've created to the device, as well as read data from it. You can also connect a USB-type LAN adaptor to directly access special Internet websites for this instrument. (An additional USB TO DEVICE terminal is provided at the rear of this instrument.) Do not disconnect the device while the READ/WRITE lamp is on or flashing. Doing so may result in loss or corruption of the data.

- 19** REGISTRATION MEMORY buttons..... Pages 52, 173
- 20** PROGRAMMABLE MUSIC FINDER button..... Pages 40, 171
- 21** FUNCTION button Page 187
- 22** VOICE CREATOR button..... Page 94
- 23** DIGITAL RECORDING button Pages 121, 161, 169
- 24** HARD DISK RECORDER buttons..... Pages 59, 135
- 25** VOICE buttons..... Pages 25, 85
- 26** PART SELECT buttons..... Pages 25, 84
- 27** PART ON/OFF buttons Pages 25, 84
- 28** VOICE EFFECT buttons..... Pages 39, 87
- 29** PROGRAMMABLE ONE TOUCH SETTING buttons..... Pages 36, 155
- 30** UPPER OCTAVE buttons Page 27
- 31** PITCH BEND wheel Page 88
- 32** MODULATION wheel Page 88

■ Rear Panel & Connections

IMPORTANT

- Since the Tyros2 has no built-in speakers, you need to monitor its sound output via external audio equipment. Alternatively, you could use a pair of headphones.

CAUTION

- Make sure that the POWER switch is in the OFF (extended) position before making any connections. If you make connections while the POWER switch is on, you risk damaging external equipment such as the amp or speakers.

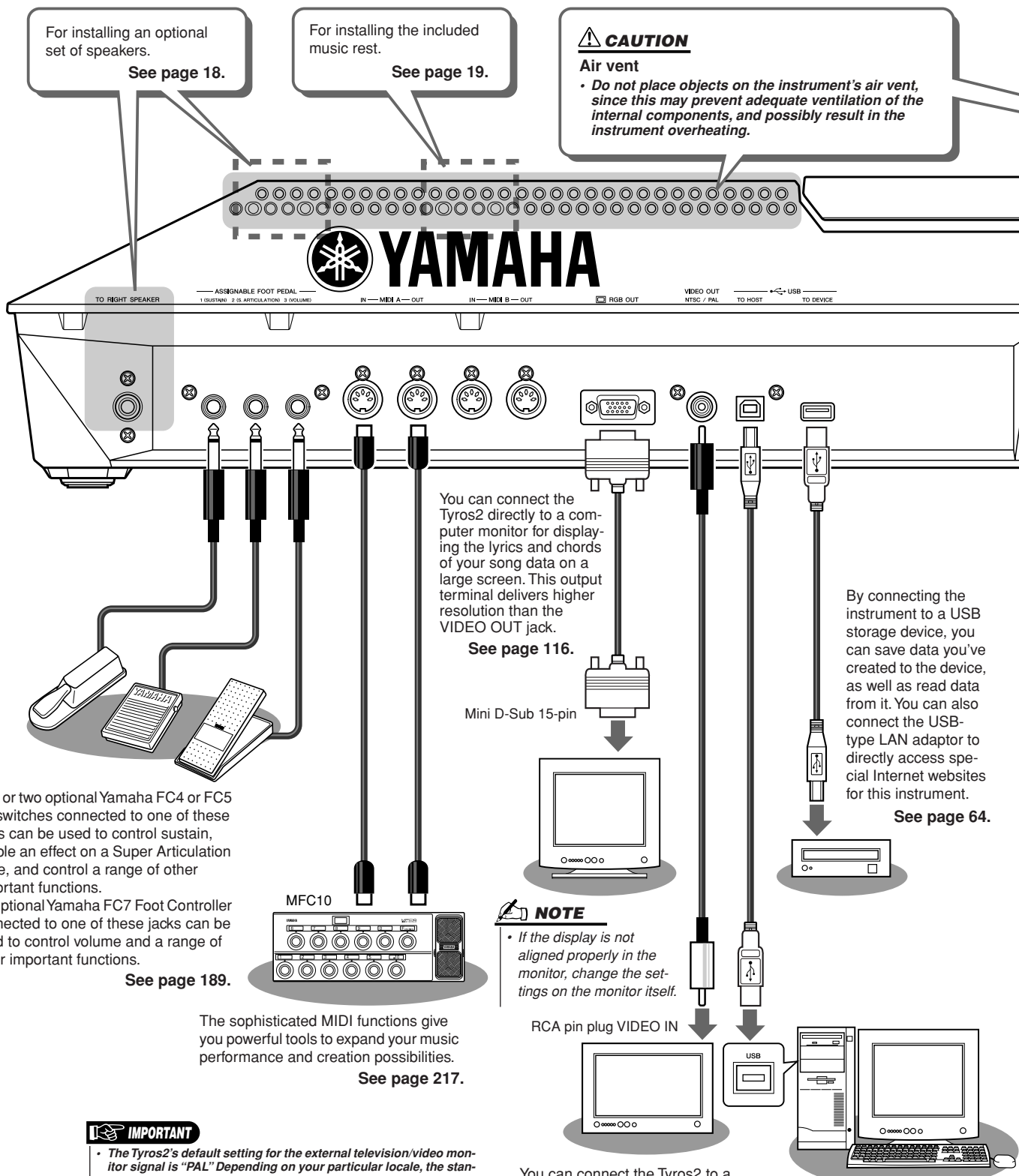

IMPORTANT

- The Tyros2's default setting for the external television/video monitor signal is "PAL." Depending on your particular locale, the standard may be different and the setting should be changed accordingly. (For example, NTSC is generally used in North America.) Check the standard used by your television or video monitor, and if it is not PAL, change the setting in the VIDEO OUT display to "NTSC" (page 188).

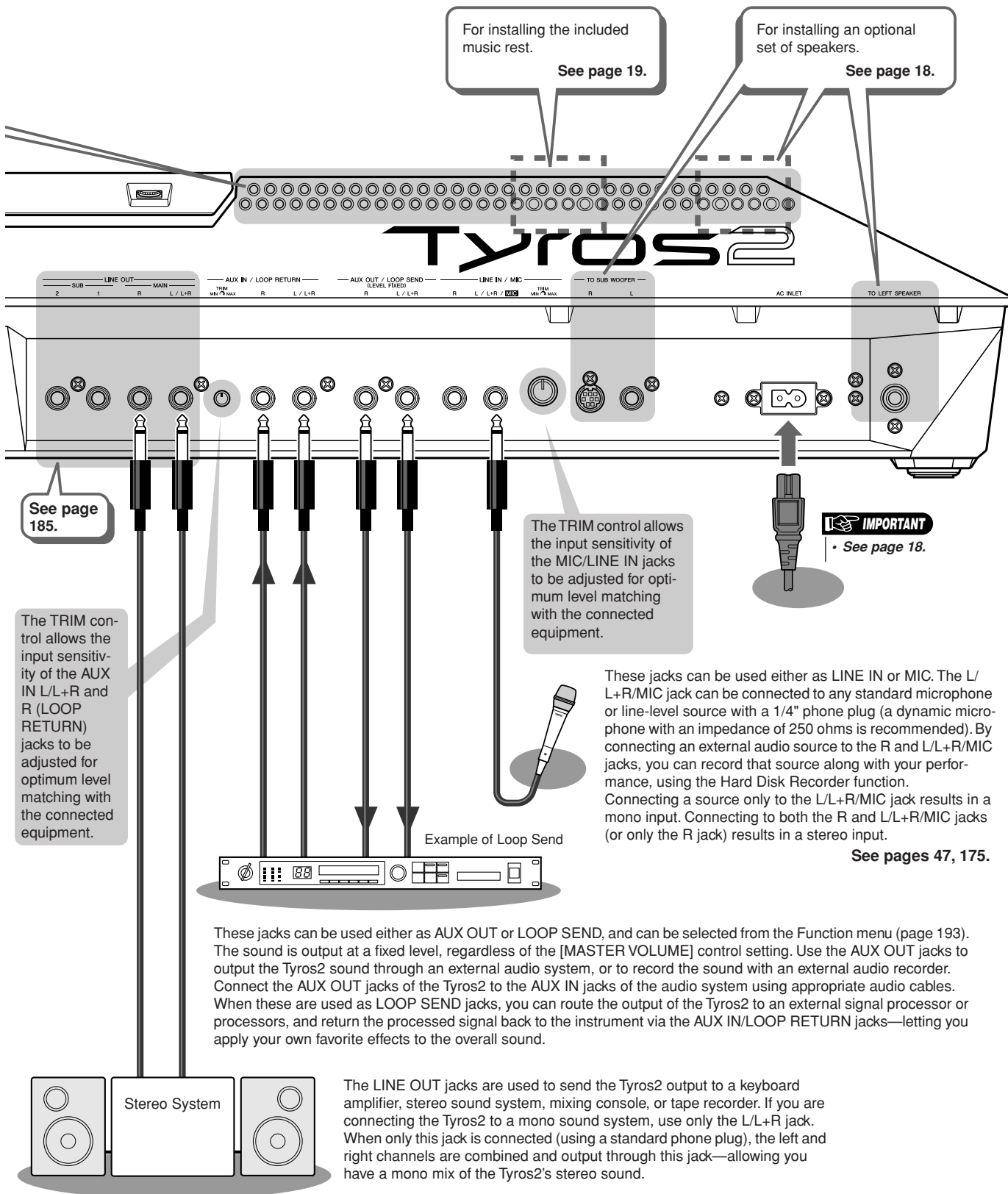

For installing the included music rest.
See page 19.

For installing an optional set of speakers.
See page 18.

See page 185.

The TRIM control allows the input sensitivity of the AUX IN L/L+R and R (LOOP RETURN) jacks to be adjusted for optimum level matching with the connected equipment.

The TRIM control allows the input sensitivity of the MIC/LINE IN jacks to be adjusted for optimum level matching with the connected equipment.

IMPORTANT
• See page 18.

These jacks can be used either as LINE IN or MIC. The L/L+R/MIC jack can be connected to any standard microphone or line-level source with a 1/4" phone plug (a dynamic microphone with an impedance of 250 ohms is recommended). By connecting an external audio source to the R and L/L+R/MIC jacks, you can record that source along with your performance, using the Hard Disk Recorder function. Connecting a source only to the L/L+R/MIC jack results in a mono input. Connecting to both the R and L/L+R/MIC jacks (or only the R jack) results in a stereo input.

See pages 47, 175.

These jacks can be used either as AUX OUT or LOOP SEND, and can be selected from the Function menu (page 193). The sound is output at a fixed level, regardless of the [MASTER VOLUME] control setting. Use the AUX OUT jacks to output the Tyros2 sound through an external audio system, or to record the sound with an external audio recorder. Connect the AUX OUT jacks of the Tyros2 to the AUX IN jacks of the audio system using appropriate audio cables. When these are used as LOOP SEND jacks, you can route the output of the Tyros2 to an external signal processor or processors, and return the processed signal back to the instrument via the AUX IN/LOOP RETURN jacks—letting you apply your own favorite effects to the overall sound.

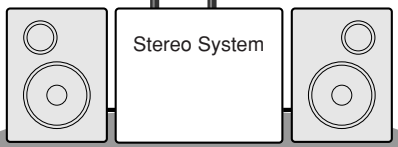

The LINE OUT jacks are used to send the Tyros2 output to a keyboard amplifier, stereo sound system, mixing console, or tape recorder. If you are connecting the Tyros2 to a mono sound system, use only the L/L+R jack. When only this jack is connected (using a standard phone plug), the left and right channels are combined and output through this jack—allowing you have a mono mix of the Tyros2's stereo sound.

Starting Up

This section contains information about setting up your Tyros2 and preparing to play. Be sure to read through this section carefully before turning the power on.

Power Supply

- 1 Make sure the POWER ON/OFF switch on the Tyros2 is set to OFF.
- 2 Connect the supplied power cord to the AC INLET terminal on the instrument's rear panel.

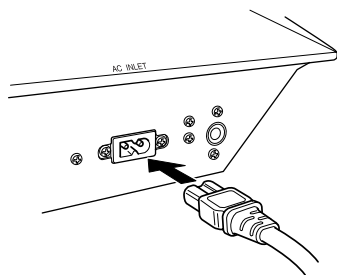

- 3 Connect the other end of the power cord to an AC outlet. Make sure your Tyros2 meets the voltage requirement for the country or region in which it is being used.

WARNING

- Make sure your Tyros2 is rated for the AC voltage supplied in the area in which it is to be used (as listed on the rear panel). Connecting the unit to the wrong AC supply can cause serious damage to the internal circuitry and may even pose a shock hazard!

WARNING

- Use only the AC power cord supplied with the Tyros2. If the supplied cord is lost or damaged and needs to be replaced, contact your Yamaha dealer. The use of an inappropriate replacement can pose a fire and shock hazard!

WARNING

- The type of AC power cord provided with the Tyros2 may be different depending on the country in which it is purchased (a third prong may be provided for grounding purposes). Improper connection of the grounding conductor can create the risk of electrical shock. Do NOT modify the plug provided with the Tyros2. If the plug will not fit the outlet, have a proper outlet installed by a qualified electrician. Do not use a plug adapter which defeats the grounding conductor.

Optional Speakers

Since the Tyros2 has no built-in speakers, you'll need to use an external speaker system—such as the optional TRS-MS02, which is designed specifically for the Tyros2. For instructions on installing the TRS-MS02 to the Tyros2, see page 219.

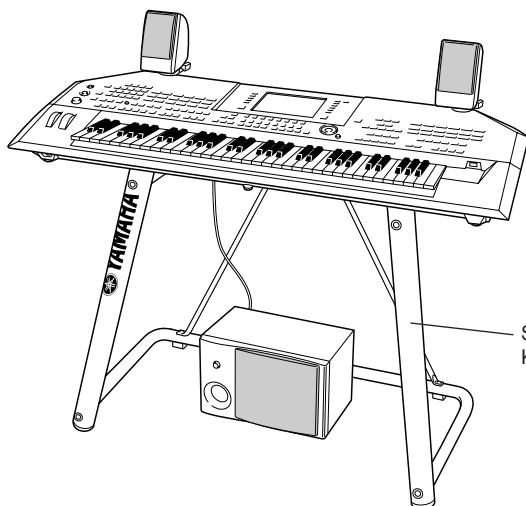

Shown here is the optional L-7S Keyboard Stand.

Music Rest

Check carefully that all parts (two music rest brackets and one music rest, shown below) are included before following the instructions below.

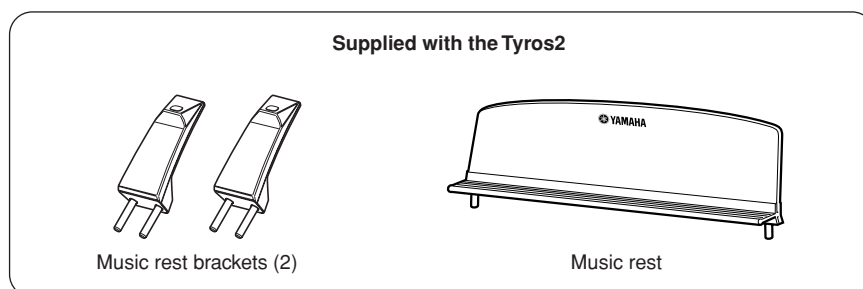

1 Attach the two music rest brackets to the rear panel of the Tyros2.

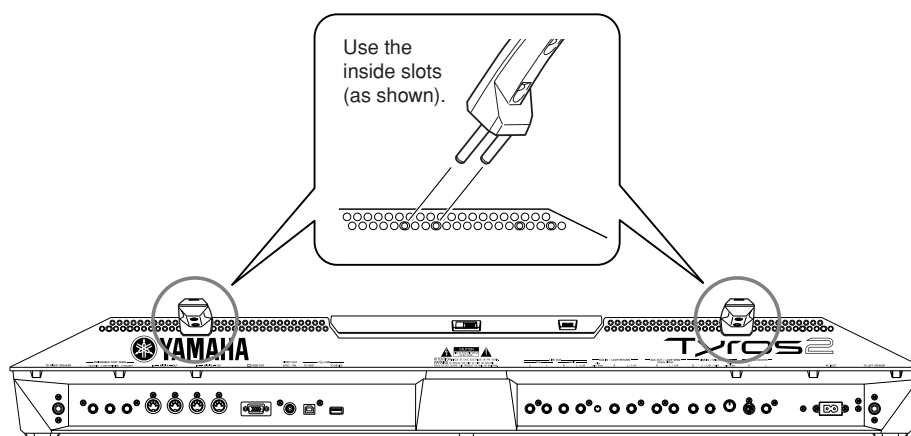

2 Attach the music rest to the brackets.

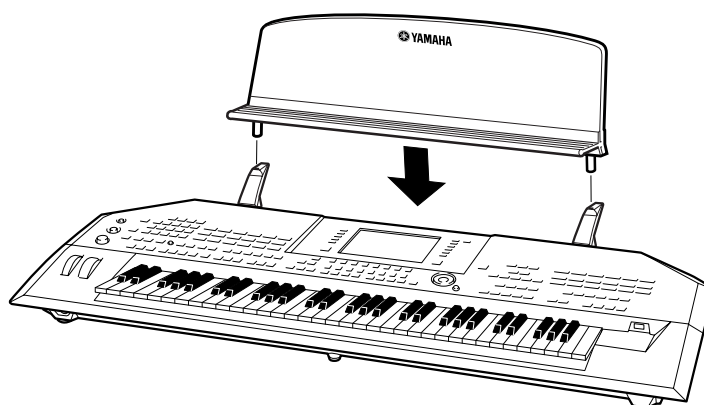

Turning the Power On/Off

Turning the Power On

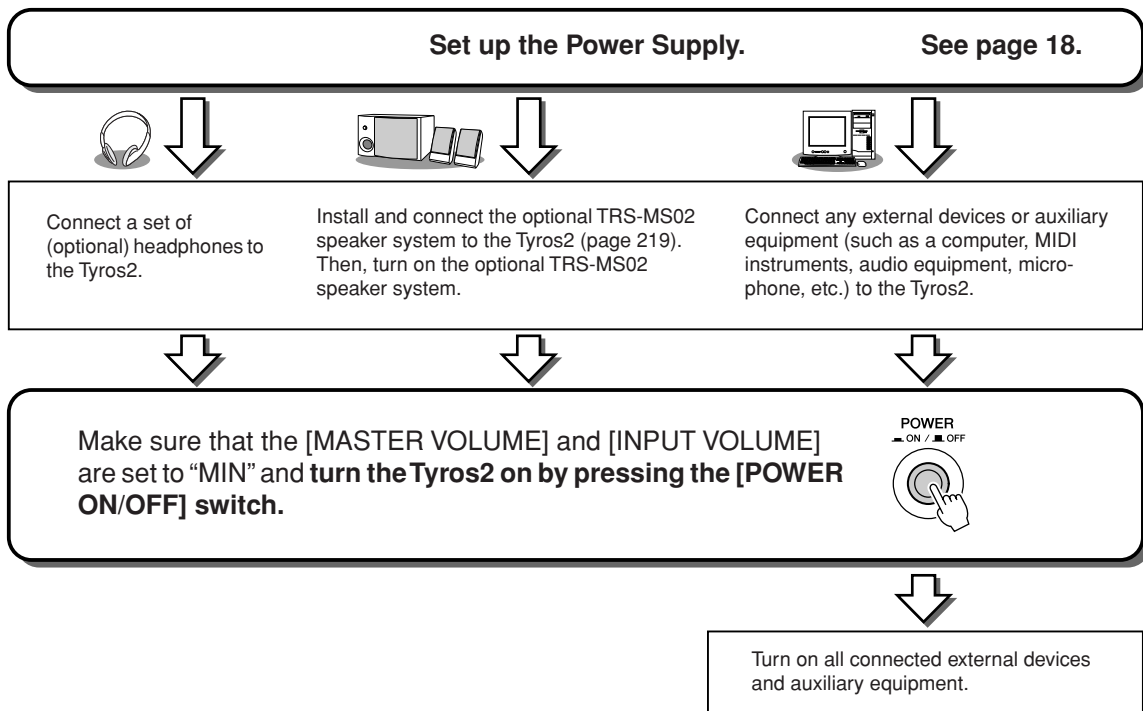

Turning the Power Off

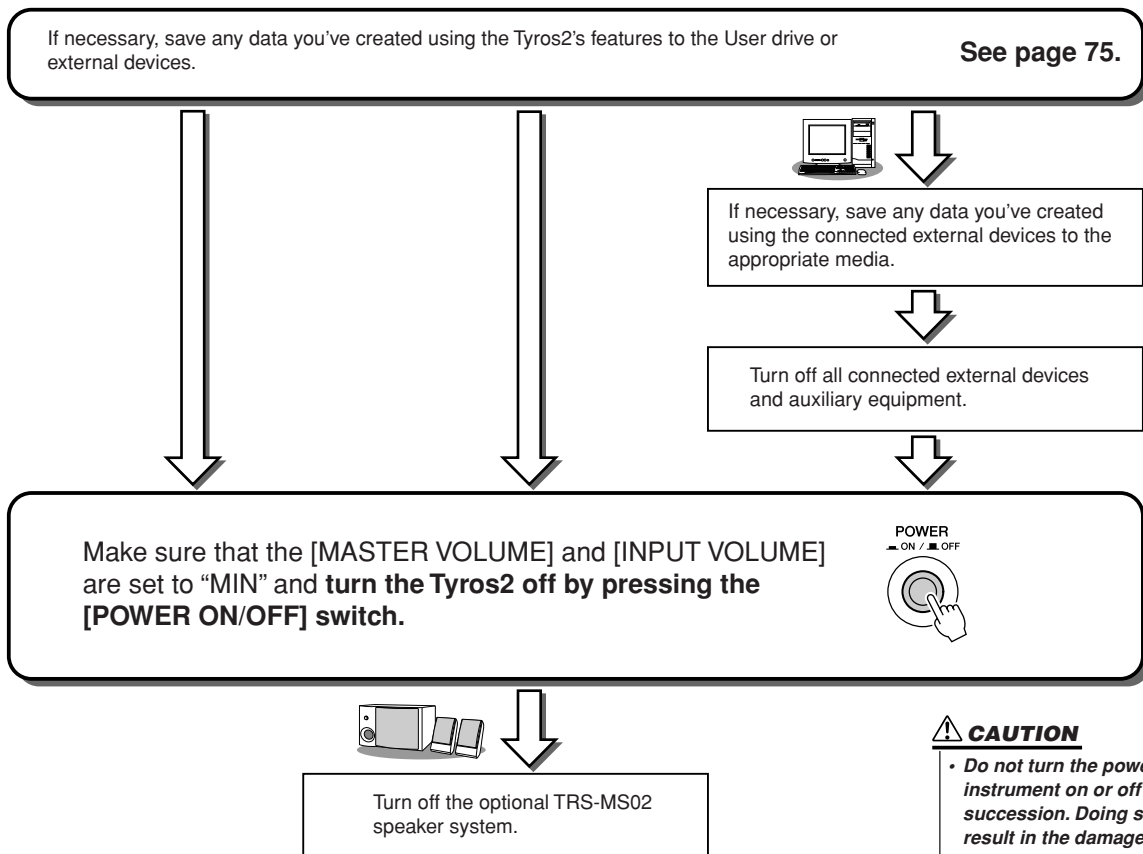

CAUTION

- Do not turn the power of the instrument on or off in rapid succession. Doing so may result in the damage to the instrument.

Raising and Closing the Display Panel

The Tyros2 features a semi-detachable display panel that can be tilted and adjusted—with four different latch points—to the most convenient viewing angle.

■ Raising the Display Panel

Unfasten the lock located at the back of the display panel. Then lift the panel and tilt it toward you.

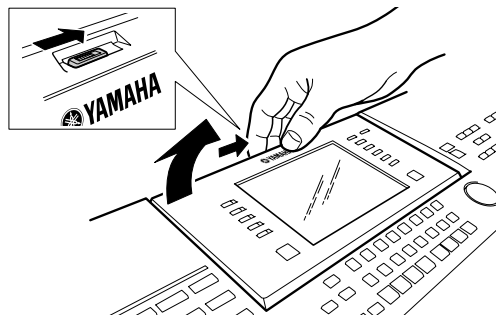

The panel will click as you tilt it back; these clicks are the four latched positions. Once you've reached a satisfactory position, release the panel. It will gently fall back to the nearest latched position.

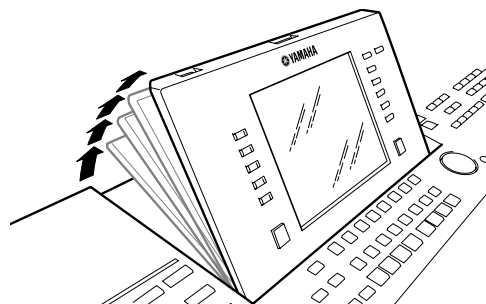

■ Closing the Display Panel

To return the panel to its closed and locked position, gently pull it back toward you until the position is vertical, then push it down until it locks into place.

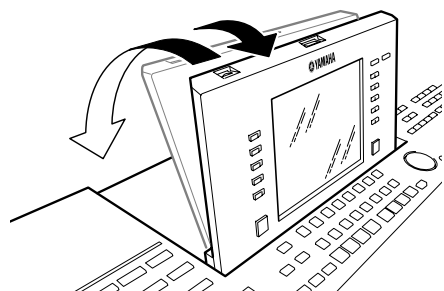

Setting the LCD contrast

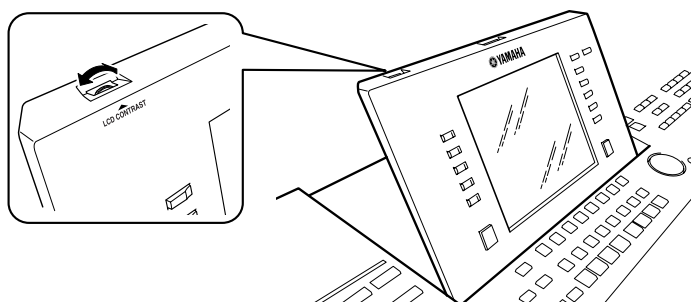

Quick Guide

Turning the Power On and Playing the Demos

The Tyros2 features an extensive variety of Demo songs that showcase its rich, authentic voices and its dynamic rhythms and styles.

[POWER ON/OFF] switch.

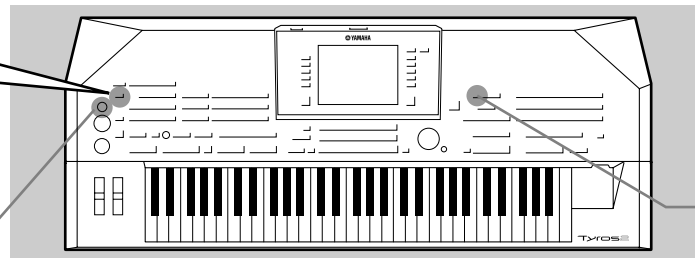

[FUNCTION] button

Turning the Power On and Viewing the Main Display

After setting up the instrument and making all necessary connections, turn the Power On by pressing the [POWER ON/OFF] switch (page 20).

An Opening “splash” display appears, followed by the Main display—which is the “home base” screen, showing the basic settings and important information for the instrument.

See below for details on each part of the Main display. Relevant page numbers for each are included.

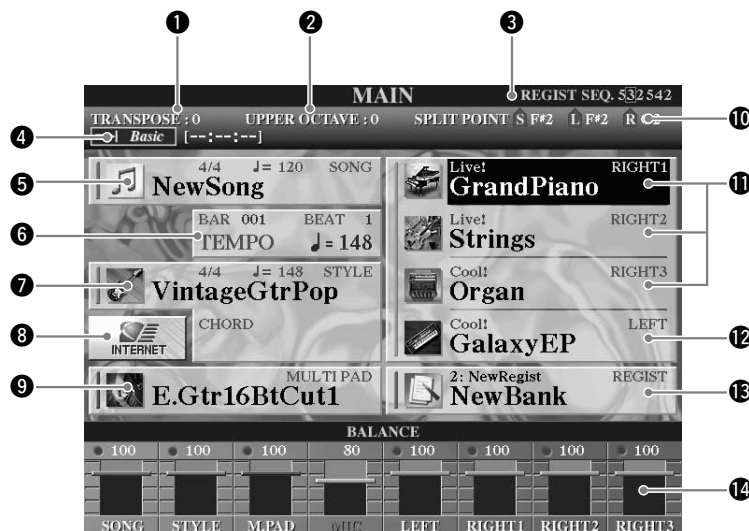

- | | |
|--|--|
| 1 Transpose Page 88 | 7 Style and chord root/type Page 31 |
| 2 Octave..... Page 27 | 8 Internet Direct Connection..... Page 197 |
| 3 Registration Sequence (displayed only when Registration Sequence Enable is set to on)..... Page 173 | 9 Multi Pad Bank Page 38 |
| 4 Audio song title selected in the Hard Disk Recorder function (The “Basic/Playlist” indicator status depends on the active mode, Basic or Playlist.) Page 147 | 10 Split point..... Page 27 |
| 5 Song Page 43 | 11 Right voices 1-3..... Pages 25, 26, 80 |
| 6 Current position (bar/beat/tempo) in song playback or style playback Pages 31, 43 | 12 Left voice Page 27 |
| | 13 Registration Memory Bank and selected Registration Memory Page 53 |
| | 14 Simple level mixer (BALANCE) Page 36 |

Changing the Language

The Tyros2 can display text in any one of five languages—English, German, French, Spanish and Italian. Text is used for the Demos (page 24) and the display messages (page 69). Select the desired language by following the instructions below.

- ▶ **1** Press the [FUNCTION] button.

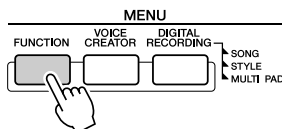

- ▶ **2** Press the [I] button to select UTILITY.

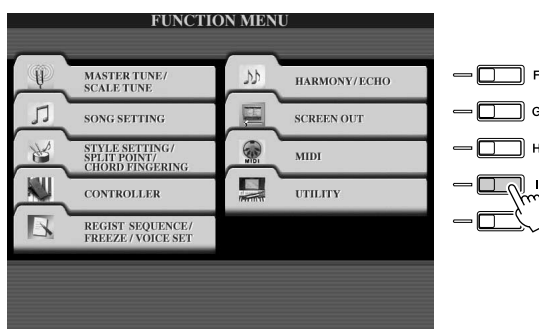

- ▶ **3** Use the [TAB] buttons to select the OWNER tab.

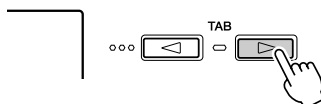

- ▶ **4** Use the [4] [5] buttons to select the desired language.

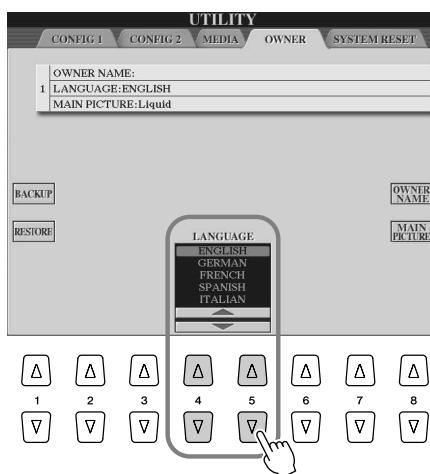

Playing the Demos

The Demos are more than just songs—they also provide helpful, easy-to-understand introductions to the features, functions and operations of the Tyros2. In a way, the Demos are an interactive “mini-manual” complete with sound demonstrations and text explaining how to use the instrument and showing what it can do for you.

- ▶ **1** Press the [DEMO] button to start repeated playback of the Demo's Overview menu displays.

The demo song plays back repeatedly, calling up the various displays in sequence.

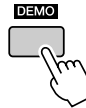

- ▶ **2** Use the [7] [8] buttons to select specific Demo topics from the Overview menu displays.

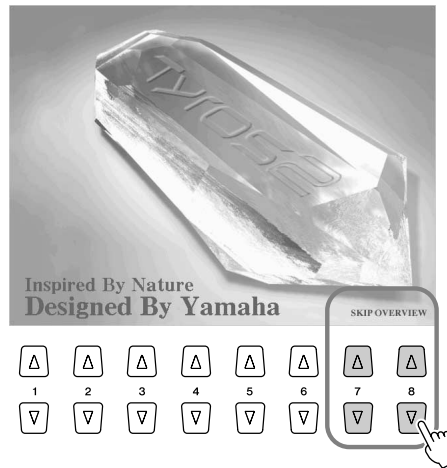

- ▶ **3** Press any of the LCD buttons to call up the display of the corresponding function.

When the demo has more than one screen, press one of the LCD [1]–[8] buttons corresponding to the screen number.

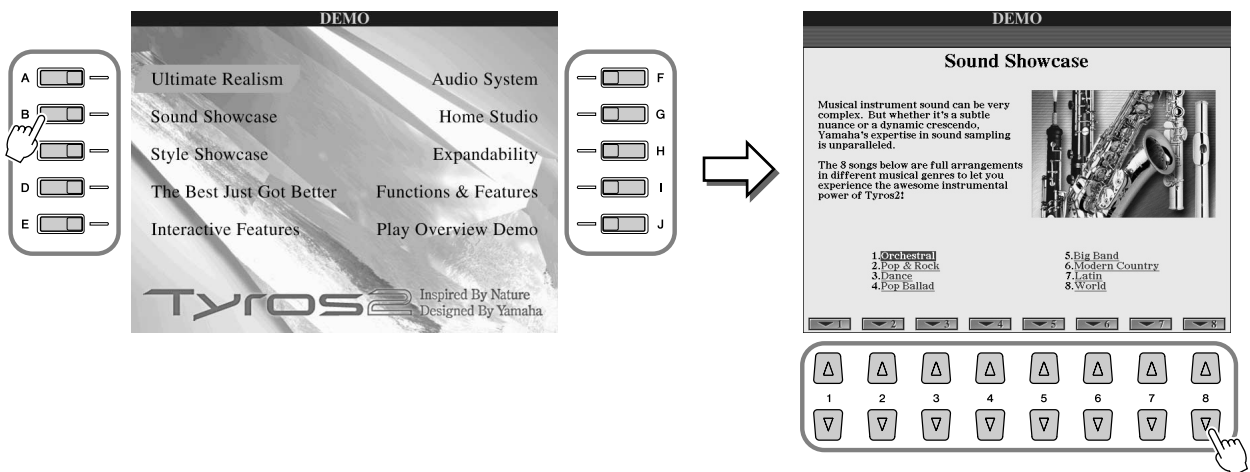

- ▶ **4** Press the [EXIT] button to exit from the Demo.

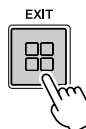

Playing Voices

Reference on page 84 →

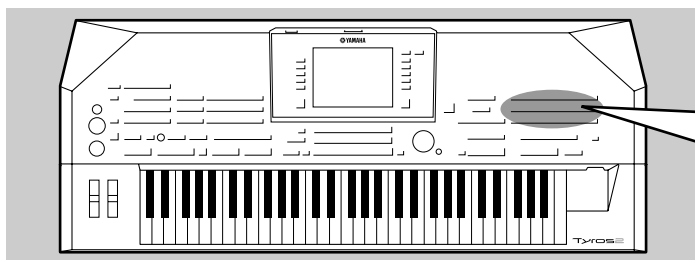

The Tyros2 has a huge selection of various musical instrument voices which you can play. Try out the different voices on your own—checking the voice name printed above each VOICE button on the panel, or referring to the voice list in the separate Data List booklet.

Selecting a Voice (RIGHT 1) and playing the keyboard

▶ **1** Turn the RIGHT 1 part on by pressing the [PART ON/OFF] button.

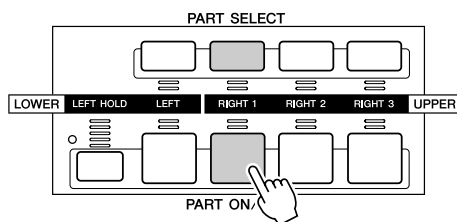

▶ **2** Press one of the [VOICE] buttons to call up the Voice selection display.

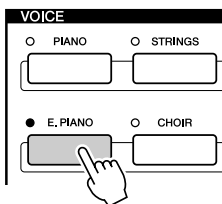

If necessary, use the [TAB] buttons to call up the PRESET page.

NOTE

- The voice selection display shown here is called the “Open/Save” display for the voice. The Open/Save display actually has two different display modes: 1) a direct selection display (shown at left), and 2) a numeric input display that lets you select the voice by inputting the voice number (file number in the folder). For details, see page 77.
- You can set Voice Open/Save display to automatically open with the currently selected voice (when one of the [VOICE] buttons is pressed) via the Voice Category Button Options setting (page 193).

▶ **3** Select a Voice.



NOTE

- The voice selected here is called voice RIGHT 1. See page 80 for more information on voice RIGHT 1.

▶ **4** Play the selected voice.

Try it out!



● **To display the voice explanations (Voice Information)**

Press the upper [6] button to display the explanation for the selected voice. To close the explanation, press the [EXIT] button.

● **To listen to the demo songs for each voice**

Press the lower [8] button to start the demo for the selected voice. To stop the demo, press the lower [8] button again.

NOTE

- Not all voices have explanations. When a voice containing the explanation is selected, [INFORMATION] is displayed on the lower of the LCD.

Playing Two or Three Voices Simultaneously

- ▶ **1** Turn the RIGHT 2 part on by pressing the [PART ON/OFF] button.

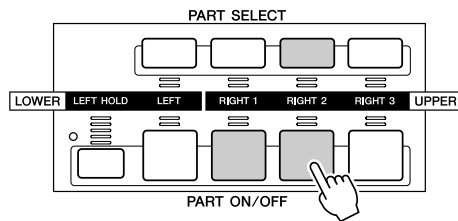

NOTE

- The voice selected here is called voice RIGHT 2. See page 80 for more information on voice RIGHT 2.

- ▶ **2** Press one of the [VOICE] buttons to call up the Voice selection display.

Do this in the same way as you did in step #2 on page 25.

- ▶ **3** Select a Voice.

Do this in the same way as you did in step #3 on page 25.

- ▶ **4** Play the selected voices.

Try it out!

The voice selected for RIGHT 1 (page 25) and the voice selected here are sounded simultaneously in a layer.

Voice RIGHT 3 can be set in the same way described above, by using the [RIGHT 3] button instead.



Try out some of the other voices...

For the characteristics of each voice, call up the corresponding information window (see page 25).

Category	Voice Name
PIANO	Live! GrandPiano
E.PIANO	Cool! SparkleStack
	Cool! SuitcaseEP
ORGAN	S.Articulation! JazzRotary
	Cool! CurvedBars
STRINGS	S.Articulation! ConcertStrings
	Live! Spiccato
	Sweet! Violin
CHOIR	Live! GospelVoices
	DreamHeaven
BRASS	S.Articulation! BigBandBrass
	S.Articulation! BrassFalls f
TRUMPET	S.Articulation! Trumpet
	S.Articulation! GoldenTrumpet
SAXOPHONE	S.Articulation! Saxophone
	Sweet! SopranoSax
FLUTE&CLARINET	Sweet! Flute
	Sweet! Oboe
	Sweet! PanFlute
GUITAR	S.Articulation! ConcertGuitar
	S.Articulation! SteelGuitar
	S.Articulation! WarmSolid
	S.Articulation! HeavyRock
PERC&DRUM	Live!Drums PowerKit1 / PowerKit2
	Live!SFX PopLatinKit
ACCORDION	FrenchMusette
	Sweet! Harmonica
PAD	S.Articulation! MagicBell
SYNTH	Oxygen

Playing Different Voices with the Left and Right Hands

- ▶ **1** Turn the LEFT part on by pressing the appropriate [PART ON/OFF] button.

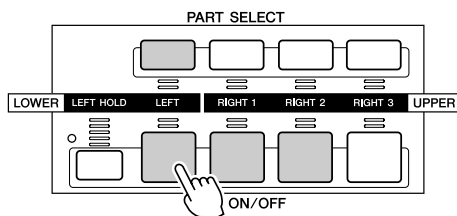

- ▶ **2** Press one of the [VOICE] buttons to call up the Voice selection display.

Do this in the same way as you did in step #2 on page 25.

- ▶ **3** Select a Voice.

Do this in the same way as you did in step #3 on page 25.

- ▶ **4** Play the selected voices.

Try it out!

The notes you play with your left hand sound one voice, while the notes you play with your right sound a different voice (or voices).

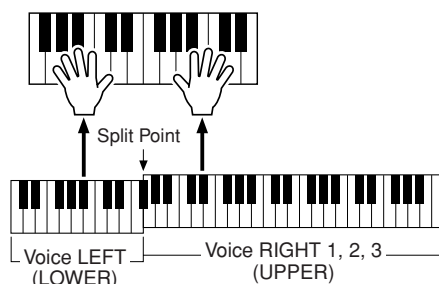

Voices RIGHT 1–3 are meant to be played with the right hand. Voice LEFT is played with the left hand.

NOTE

- The point on the keyboard that separates voice LEFT, RIGHT 3 and RIGHT 1–2 is called the “split point.” Refer to page 158 for instructions on setting the split point.

Adjusting the Octave Setting

The [UPPER OCTAVE] button allows the RIGHT 1, RIGHT 2, and RIGHT 3 parts to be simultaneously transposed up or down by one octave.

NOTE

- Press the [+] and [-] buttons simultaneously to instantly reset the octave value to 0.

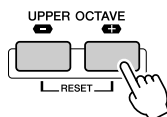

Organ Flutes

The Tyros2 uses advanced digital modeling technology to recreate the legendary sound of vintage organs. Just as on a traditional organ, you can create your own sound by increasing and decreasing the levels of the flute footages.

- ▶ **1** Press the [ORGAN FLUTES] button to call up the Organ Flutes voice selection display.

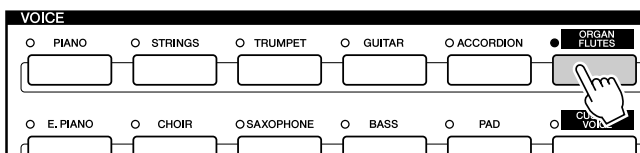

- ▶ **2** Select the desired Organ voice and play the keyboard. *Try it out!*



- ▶ **3** Press the upper [5] button to call up the display for adjusting various parameters of the Organ Flutes voice. Use the LCD [1]–[8] buttons to adjust the footage settings.

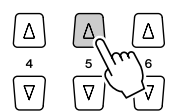

You can select the desired footage (16' or 5 1/3') with the [D] button. Use LCD [1] button to adjust the 16' or 5 1/3' footage.

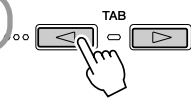

Use these to select the desired page of parameters.

CAUTION

If you wish to store the settings here, make sure to save the settings as a User Voice before selecting another voice or turning the power off (page 75).

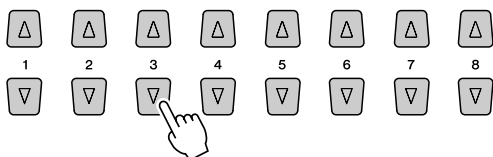

The footage settings determine the basic sound of the organ flutes. The term "footage" is a reference to the sound generation of traditional pipe organs, in which the sound is produced by pipes of different lengths (in feet).

- ▶ **4** Try out some of the other Organ Flutes voices.

Collecting your favorite voices to the User drive or external devices

The Tyros2 has a huge amount of high-quality voices, covering an exceptionally broad range of instrument sounds—making it perfect for virtually every musical application. However, the sheer number of voices may seem overwhelming at first. That’s why we’ve decided to show you this somewhat advanced technique for gathering together the voices you like to use the most, and putting them in one easy-to-use location.

To start with, you should know a little about the Memory Drives and the Open/Save display (explained briefly below). Should you want to know more, details are given on page 71. For the moment, though, keep in mind that the User drive, USB drive and Hard Disk drive are memory locations that you can use to store and recall your important data.

● Memory Drive Types

PRESET drive	Internal memory drive to which the pre-programmed voices are installed as preset voices.
USER drive	Internal memory that allows both reading and writing of data.
HD (Hard Disk) drive (optional)	For transferring data to and from a hard disk drive installed to the instrument.
USB drive (optional)	For transferring data to and from a connected USB storage device.

- **Open/Save display** From this type of display you can select (open) various files—such as voices, (pages 25–28), styles (page 31), songs (page 43), and Registration Memory banks (page 53)—as well as save the various files to the User drive, USB drive and Hard Disk drive.

▶ 1 Press the [USER DRIVE] button to call up the Voice selection (Open/Save) display for the User drive.

In this case, any keyboard part (RIGHT 1–3) can be selected.



▶ 2 From this display (path), make a new folder to which your favorite voices are to be saved.

Press the [FOLDER] LCD button (lower [7] button).

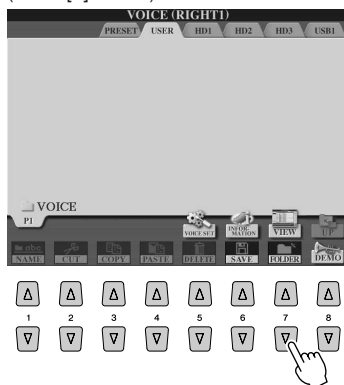

Press the [OK] LCD button (upper [8] button).

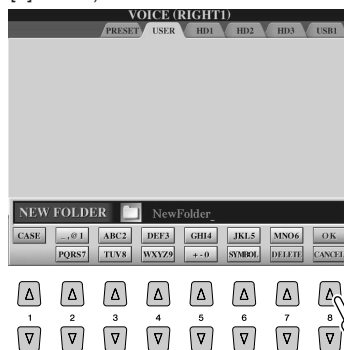

The new folder is created.

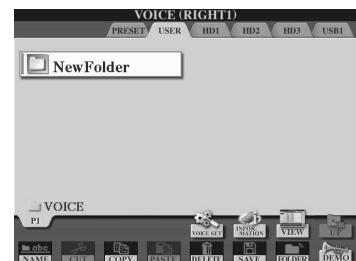

You can name the new folder from the pop-up window that appears at the bottom of the LCD display.
For details about naming, see page 76.

▶ 3 Copy your favorite voices from the Preset drive to the User drive.

In this case, any keyboard part (RIGHT 1–3) can be selected.

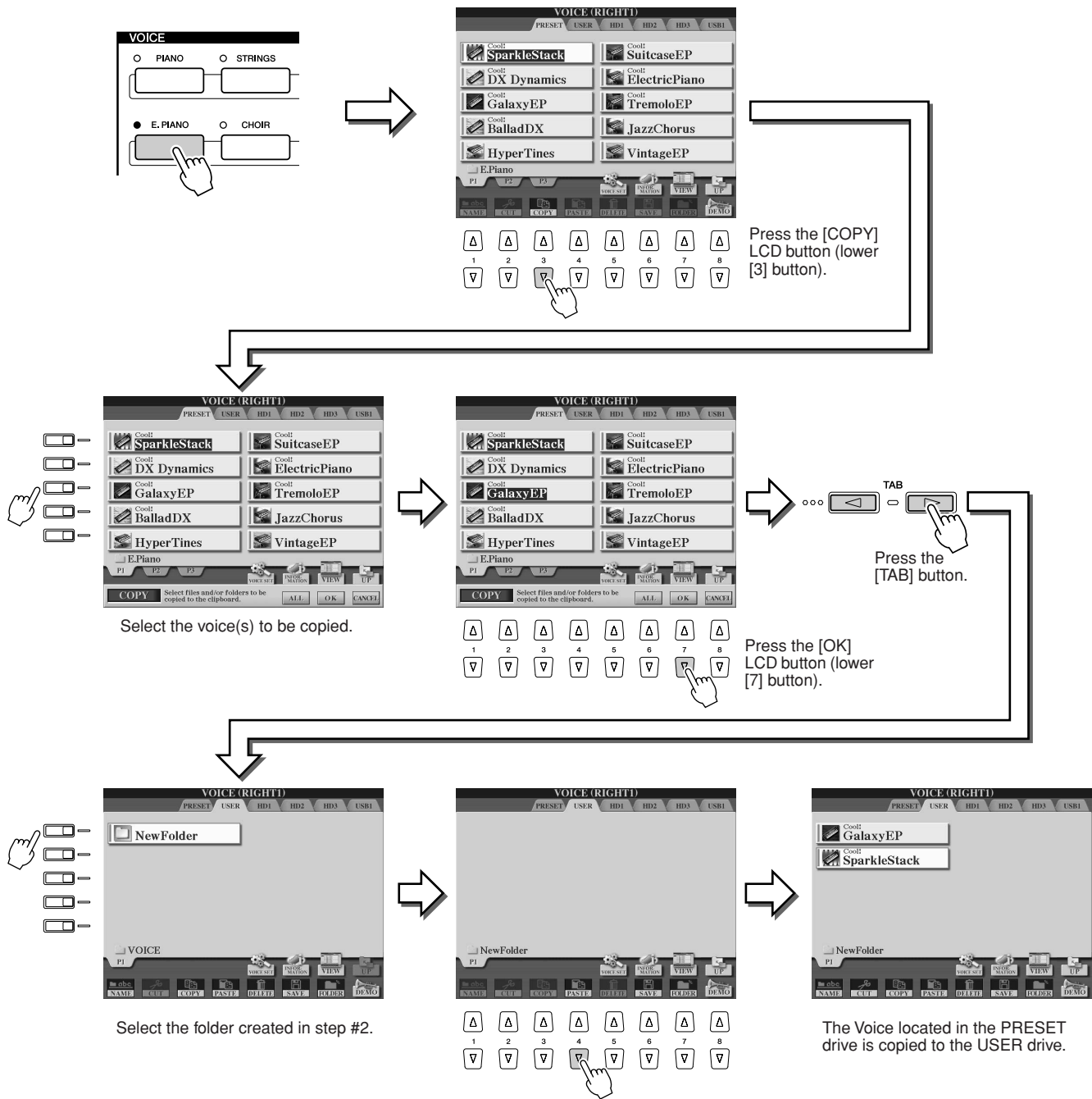

▶ 4 Repeat step #3 as often as necessary until all your favorite voices are contained in this display.

Also try copying preset voice(s) to the external device in the same way as explained here.

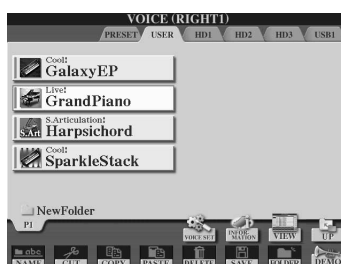

Selecting and Playing a Style—Auto Accompaniment (ACMP)

Reference on page 152 →

The auto accompaniment (style playback) feature puts a full backing band at your fingertips. To use it, all you have to do is play the chords with your left hand as you perform and the selected accompaniment style matching your music will automatically play along, instantly following the chords you play. With the auto accompaniment (style playback) function, even a solo performer can enjoy playing with the backing of an entire band or orchestra.

The Tyros2 features a variety of accompaniment styles (rhythm patterns) in a variety of different musical genres. Try out the different styles on your own—checking the style category name printed above each STYLE button on the panel, or referring to the style list in the separate Data List booklet.

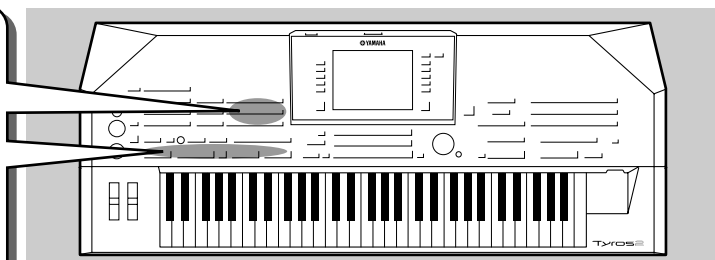

Playing a melody with your right hand and playing chords with your left hand

▶ **1** Press one of the [STYLE] buttons to call up the Style selection display.

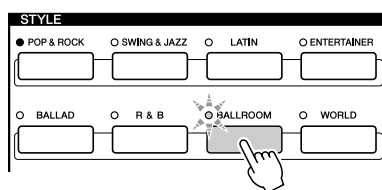

NOTE

The style selection display shown here is called the “Open/Save” display for the style. The Open/Save display actually has two different display modes: 1) a direct selection display (shown at left), and 2) a numeric input display that lets you select the style by inputting the style number (file number in the folder). For details, see page 77.

▶ **2** Select a Style.



NOTE

To select a drive other than PRE-SET, use the [TAB] buttons.

▶ **3** Turn Auto Accompaniment on.

Press the [ACMP] button so that its indicator lights. The specified left-hand section of the keyboard becomes the Chord section, and chords played in this section are automatically detected and used as a basis for fully automatic accompaniment with the selected style.

Press the [ACMP] button again to turn Auto Accompaniment off.

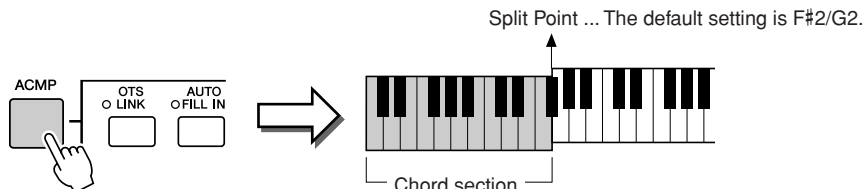

NOTE

ACMP is an abbreviation for ACCOMPANIMENT.

NOTE

For details about the Split Point, see pages 80 and 158.

▶ **4** Turn Sync Start on.

Press the [SYNC START] button to enable synchronized start (standby). (The indicator lights.) Press the [SYNC START] button again to turn Sync Start off.

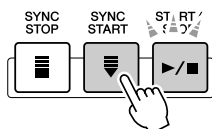

NOTE

The [START/STOP] button flashes in sync with the current tempo (page 154) while Sync Start is on.

▶ **5** As soon as you play a chord with your left hand, the selected style starts.

For this example, play a C major chord (as shown below).

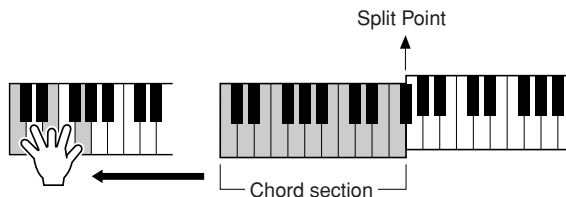

NOTE

- The [START/STOP] button flashes in sync with the beat. The red color flashes at the first beat and the green color flashes at the other beats.

▶ **6** Try playing other chords with your left hand and play a melody with your right hand. *Try it out!*

For information on how to enter chords, see page 152 and the Chord Fingering Chart listed in the separate Data List booklet.

The chord root/type specified with your left hand will be shown at the center of the Main display.

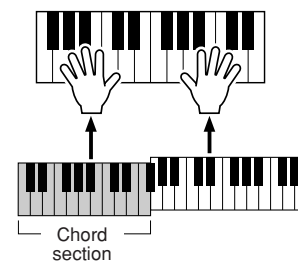

▶ **7** Press the [START/STOP] button to stop style playback.

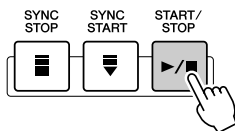

Try out some of the other styles...

Category	Style Name	Comment
Pop&Rock	AcousticRock	This style demonstrates a modern high quality production. Listen to Intro II leading into Main B to hear a realistic band sound of today.
Ballad	16BeatBallad1	Ultimate realism is a main focus of Tyros2. Listen to the new Mega Tenor Sax in Intro III.
Dance	70'sDisco1	No matter what genre, Tyros2 will deliver uncanny realism. Listen to the Disco Strings, Mega Brass and Mega Solid guitar in both Intro II and Intro III. You can play many 70's Disco favourites.
Swing&Jazz	OrchBigBand1	An authentic Big Band sound which has had a recent revival. Great for many Big Band/Jazz standards sung by some of the greats. Listen to the Brass shakes in Intro III.
R&B	BluesRock	This genre is also typical of the late seventies. If you sit back and close your eyes, it is tough to differentiate between a keyboard and the real thing. Listen to Intro III followed by MainD.
	70'sChartSoul	Another great R&B flavour. This really shows off the New Mega Tenor Sax and Mega Brass. Listen to both Intro II and Intro III.
Country	EasyCountry	Country music covers many different sound fields and styles. With EasyCountry you can hear a very typical laid back singer song writer image. Great for many standards.
	CountryShuffle	A typical sing-a-long country feel with a very high quality production. Listen to Intro III to hear a straight to point Country image.
Latin	BossaNova	This style can be used for almost all bossa nova standards. Intro II demonstrates an unbelievable Mega Nylon guitar complete with slides and noises for extra realism. Intro III introduces the Sax but with a much softer tone.
Ballroom	EnglishWaltz	Take your partner by the hand and dance the night away. The Ballroom category caters for all Ballroom dancing music to the highest level. Listen to both Intro II and Intro III. When you hear the Trumpets come in, you could be sitting in front of a real Ballroom Orchestra.
Movie&Show	BaroqueConcerto	To show the versatility of style genres, just play the Intros and Mains of this style. You're immediately taken into the 17th Century.
Entertainer	EuroPopOrgan	A big Entertainment genre is that of the Euro organist of the 60's and 70's. This style is very versatile covering many songs, but this shows the power of Tyros2 whether you are listening to Orchestral realism or straight forward organ music. It's all unbelievable.
World	IrishHymn	A great Celtic sound which has become very popular over recent years. Play either Intro which will take you on a journey to Ireland. This will also remind many of great movie scores.

■ Repertoire function

The convenient, easy-to-use Repertoire function automatically calls up appropriate panel settings designed to match the selected style.

- ▶ **1 Press the [REPERTOIRE] LCD button (upper [6] button) in the style Open/Save display.**

Various appropriate panel settings matching the selected style will be shown in the display.

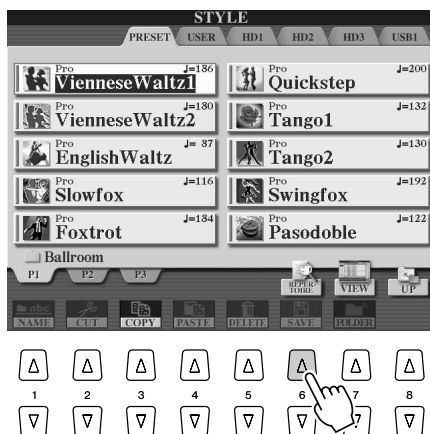

- ▶ **2 Use the [1]–[3] buttons to select a setting.**

The settings shown here are Music Finder Records. You can choose additional settings by using the Music Finder feature (page 41).

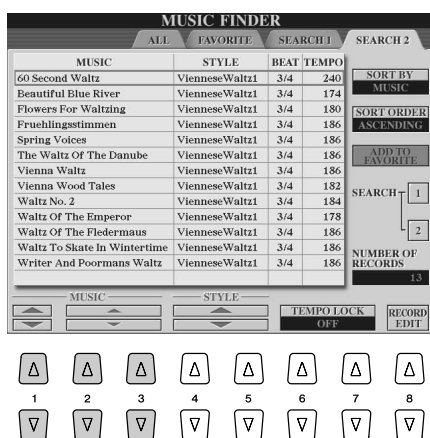

■ Stop Accompaniment function

When auto accompaniment is turned on and Synchro Start is off, you can play chords in the left-hand (accompaniment) section of the keyboard with the style stopped, and still hear the accompaniment chord. In this condition—called “Stop Accompaniment”—any valid chord fingerings (page 152) are recognized and the chord root/type are shown in the LCD. Since the Tyros2 properly recognizes the chord, you can also use the Chord Match function (page 38) with the Multi Pads or the Harmony effect (page 39) without having to play back a style.

Pattern Variation (Sections)

The Tyros2 features a wide variety of style “sections” that allow you to vary the arrangement of the accompaniment to match the song you are playing. They are: Intro, Main, Fill-in, Break and Ending. By switching among them as you play, you can easily produce the dynamic elements of a professional-sounding arrangement in your performance.

NOTE

Depending the selected style, not all sections may have data. The lamp of the section button that contains data lights in green, and the lamp of the section button that contains no data does not light (page 79).

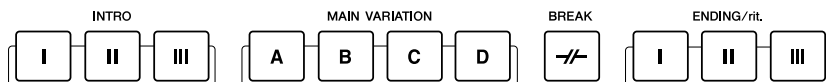

- **INTRO**.....This is used for the beginning of the song. When the intro finishes playing, style playback shifts to the main section. The length of the intro (in measures) differs depending on the selected style. The Tyros2 also features three different intros.
- **MAIN**.....This is used for playing the main part of the song. It plays a rhythm pattern of several measures, and repeats indefinitely until another section’s button is pressed. There are four variations on the basic pattern, A–D and the style playback sound changes harmonically based on the chords you play with your left hand.
- **FILL IN**.....The fill-in sections let you add dynamic variations and breaks in the rhythm of the accompaniment, to make your performance sound even more professional. Turn the [AUTO FILL IN] button on, simply press one of the MAIN (A, B, C, D) buttons as you play, and the selected fill-in section plays automatically (AUTO FILL), spicing up the auto accompaniment. When the fill-in is finished, it leads smoothly into the selected main section (A, B, C, D). There are four variations for the fill-in sections, each specially programmed to match the selected main section. Even when [AUTO FILL] is turned off, pressing the same button of the currently playing section automatically plays a fill-in before returning to the same main section.
- **BREAK**.....This lets you add dynamic breaks in the rhythm of the accompaniment, to make your performance sound even more professional.
- **ENDING**.....This is used for the ending of the song. When the ending is finished, the style playback stops automatically. The length of the ending (in measures) differs depending on the selected style. The Tyros2 features three different endings.

▶ **1-4** Select the desired style using the steps described on page 31.

▶ **5** Turn [AUTO FILL IN] on.

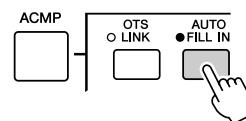

▶ **6** Press any of the [INTRO] buttons.

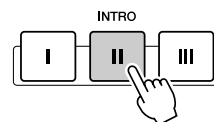

▶ **7** As soon as you play a chord with your left hand, the Intro of the selected style starts.

For this example, play a C major chord (as shown below).

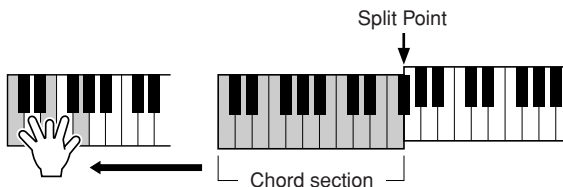

When the playback of the intro is finished, it automatically leads into the main section.

▶ **8** Press any of the accompaniment section buttons as desired. (See the Accompaniment Structure Diagram on the next page.)

Try it out!

After the corresponding Fill-in is played back, it automatically leads to the main section.

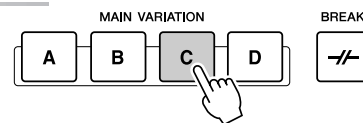

▶ **9** Press any of the [ENDING] buttons.

This switches to the ending section. When the ending is finished, style playback automatically stops.

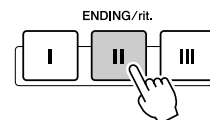

■ Accompaniment Structure Diagram

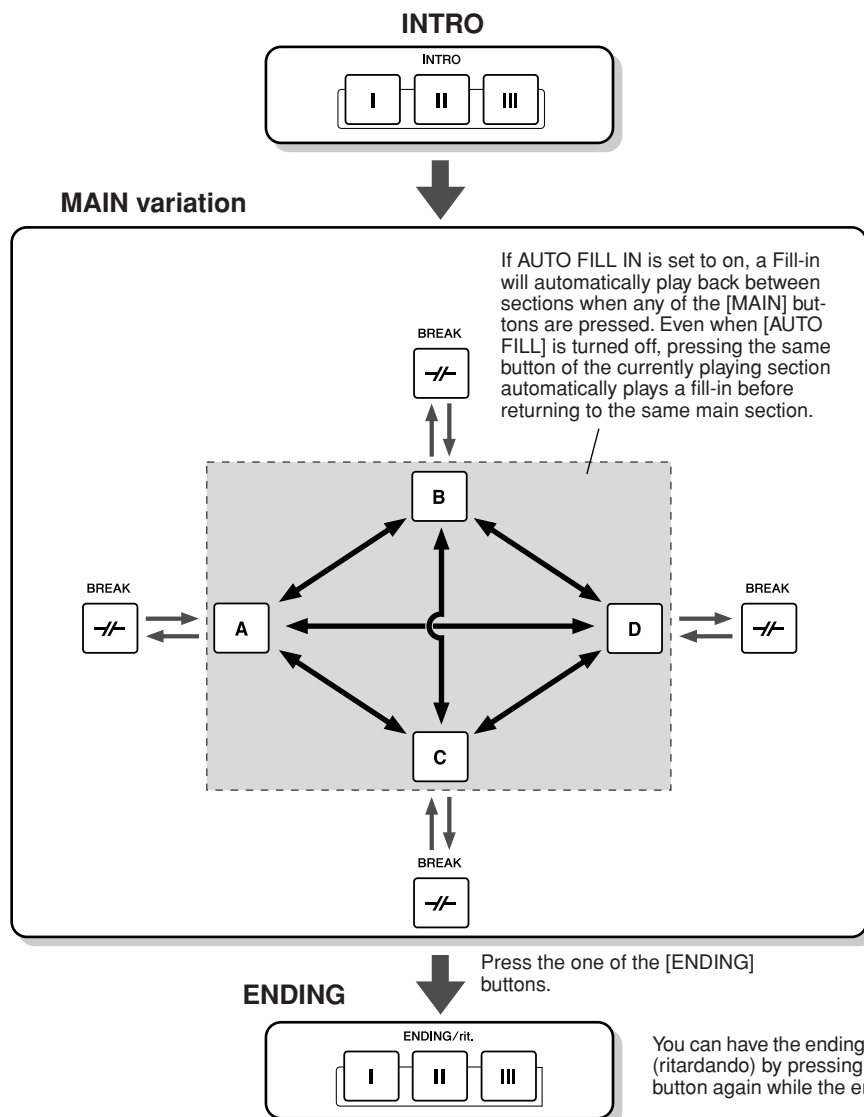



NOTE

- The section button lamps are conveniently color-coded as to their particular operation, as described below.
 - **Off**
The section contains no data and cannot be played.
 - **Green**
The section contains data and can be played.
 - **Red**
During style playback, this indicates the section that is currently playing. When style playback is stopped, this indicates the section that is set to play.
 - **Red (flashing)**
This indicates the section that will be played next, following the one whose button is lit up in red (not flashing).

NOTE

- The indicator of the destination section (MAIN A/B/C/D) will flash while the corresponding fill-in is playing. During this time you can change the destination section by pressing the appropriate MAIN [A], [B], [C] or [D] button.
- An Intro does not necessarily have to be at the beginning! If you want, you can play an Intro section in the middle of your performance by simply pressing the [INTRO] button at the desired point.
- Watch your timing with the Break sections. If you press a [BREAK] button too close to the end of the measure (i.e., after the final eighth note), the Break section starts playing from the next measure. This also applies to the Auto Fill-in.
- If you want to come back into the style right away after an Ending, simply press the [INTRO] button while the Ending section is playing.
- If you press one of the [MAIN] button while the ending is playing, a fill-in will immediately start playing (when the [AUTO FILL IN] is turned on), continuing with the main section.
- If you press the [SYNC START] button while a style is playing, style playback will stop and Synchro Start will be set to on.
- You can begin style playback by using an ending instead of an intro section.
- Pressing the [ENDING I] button during playback of the Main section automatically plays a fill-in before playing back the Ending.

■ Other Convenient Controls

- **Fade in/out** The [FADE IN/OUT] button can be used to produce smooth fade-ins and fade-outs when starting and stopping the accompaniment. This also applies to song playback. page 154

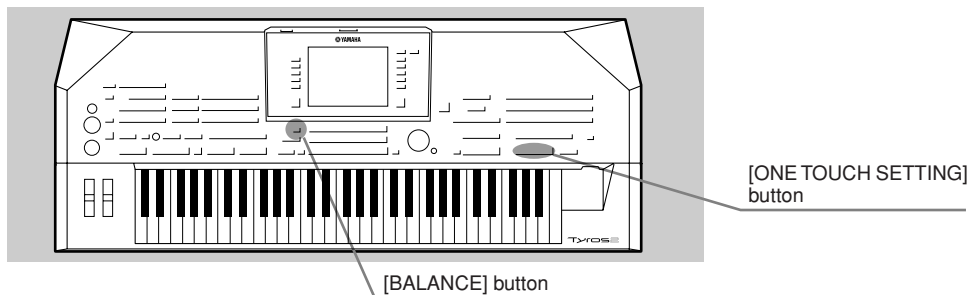
- **Tap** The auto accompaniment can be started at any tempo you desire by “tapping” out the tempo with the [TAP TEMPO] button. page 154

- **Synchro Stop** When the Synchro Stop function is engaged, accompaniment playback will stop completely when all keys in the auto-accompaniment section of the keyboard are released. Accompaniment playback will start again as soon as a chord or note is played. page 155

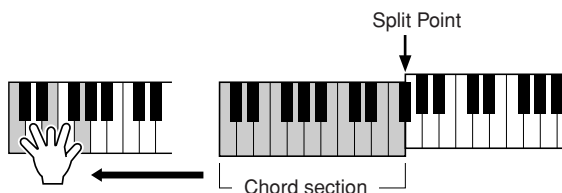
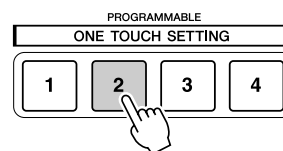

One Touch Setting

One Touch Setting is a powerful and convenient feature that automatically calls up the most appropriate panel settings (voice number, etc.) for the currently selected style, with the touch of a single button.

- ▶ **1** Select a style.
- ▶ **2** Press one of the [ONE TOUCH SETTING] buttons.
Auto Accompaniment and Sync Start will automatically be turned on. In addition, various panel settings (such as voices, effects, etc.) that match the selected style can be instantly recalled with just a single button press.
- ▶ **3** As soon as you play a chord with your left hand, the style starts.



- ▶ **4** Try out other One Touch Setting setups. *Try it out!*

- ▶ **5** Stop style playback by pressing the STYLE [START/STOP] button or any of the [ENDING] buttons.

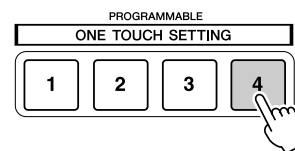

You can also create your own One Touch Setting setups. For details, refer to page 155.

Adjusting the Volume Balance between the Style and the Keyboard

Press the [BALANCE] button so that the mixer window (pop-up) appears at the bottom of the LCD display. You can adjust the volume balance between style playback and your right-hand keyboard performance by using LCD buttons [2], [5], [6], [7], and [8].

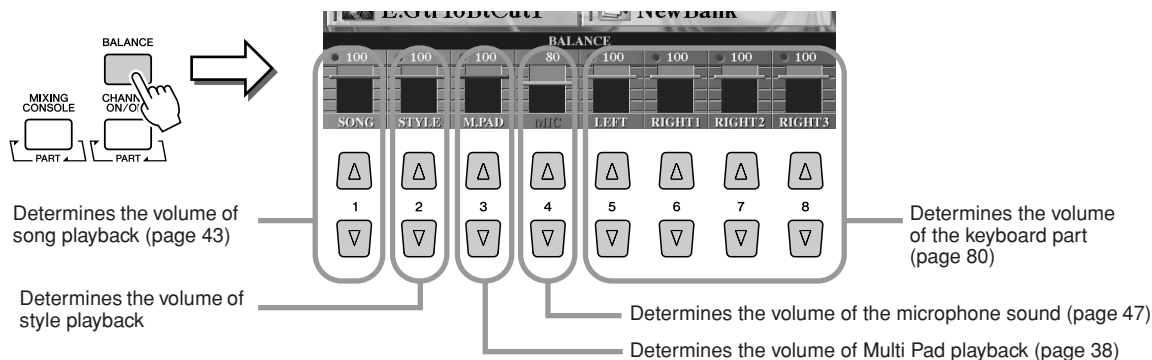

Turning Style Parts On/Off and Changing Voices

Press the [CHANNEL ON/OFF] button so that the pop-up window appears at the bottom of the LCD display. You can turn each part (channel) on or off by using the lower LCD [1]–[8] buttons during style playback. Pressing any of the upper LCD [1]–[8] button calls up the voice selection display which lets you select and change the voice of the corresponding part (channel). Try replacing the default voice with different voices of your own selection.

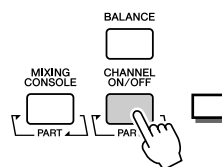

Pressing the [CHANNEL ON/OFF] button repeatedly switches among the style parts (channels) and song channels.

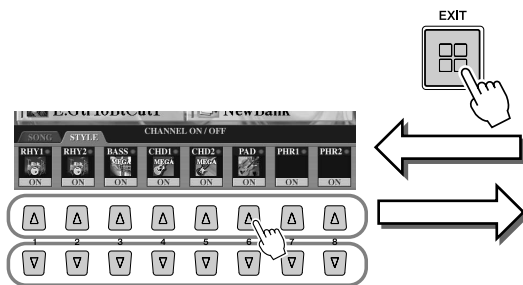

Press the corresponding LCD button. To listen to only one instrument by itself, hold down the appropriate button for the channel to set the channel to SOLO. To cancel SOLO, simply press the appropriate channel button again.

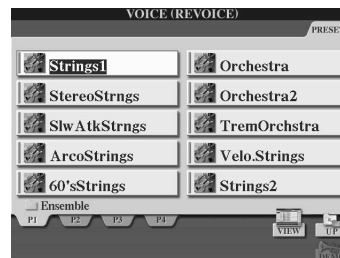

From this display, you can change the voice used by the style. Select the desired voice in the same way as described on page 25.

The Multi Pads

Reference on page 169 →

The Multi Pads can be used to play a number of short pre-recorded rhythmic and melodic sequences that can be used to add impact and variety to your keyboard performances.

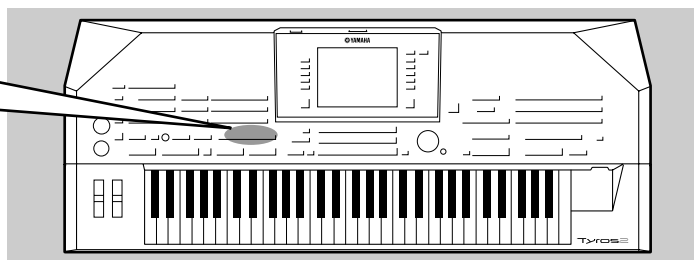
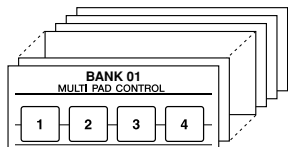

Playing the Multi Pads

1 Select a Multi Pad Bank.

Press the [SELECT] button to call up the Multi Pad Bank selection (Open/Save) display and select the desired Bank.

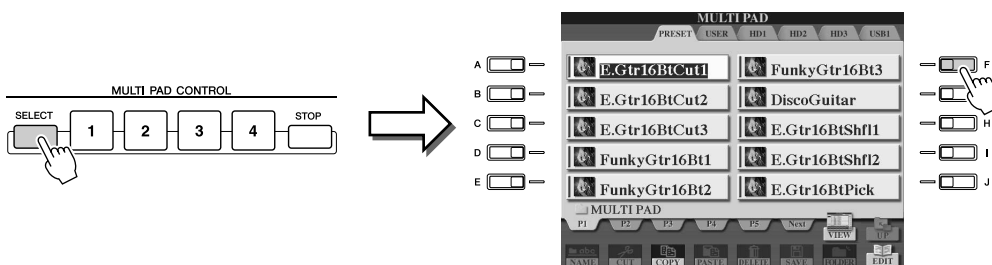

2 Press any of the Multi Pads.

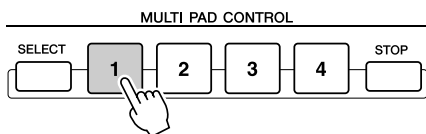

The corresponding phrase (in this case, for Pad 1) starts playing back in its entirety as soon as the pad is pressed. To stop it, press and release the [STOP] button.

NOTE

- Simply tap any of the Multi Pads at any time to play back the corresponding phrase at the currently set tempo.
- You can even play two, three, or four Multi Pads at the same time.
- Pressing the pad during its playback will stop playing and begin playing from the top again.

● About the color of the Multi Pads

- Green: Indicates that the corresponding pad contains data (phrase).
- Red: Indicates that the corresponding pad is playing back.

● Multi Pad data

There are two types of Multi Pad data. Some types will play back once and stop when they reach to the end.

Others will play back repeatedly until you press the [STOP] button.

● Stopping playback of the Multi Pads

- To stop all pads, press and release the [STOP] button.
- To stop specific pads, simultaneously hold down the [STOP] button and press the pad or pads you wish to stop.

Using Chord Match

Many of the Multi Pad phrases are melodic or chordal and you can have these phrases automatically change chords as you do with your left hand. While a style is playing back and [ACMP] is on, simply play a chord with your left hand and press any of the Multi Pads—Chord Match changes the pitch to match the chords you play. You can also use this with the style stopped (with the Stop Accompaniment function; page 33). Keep in mind that some Multi Pads are not affected by Chord Match.

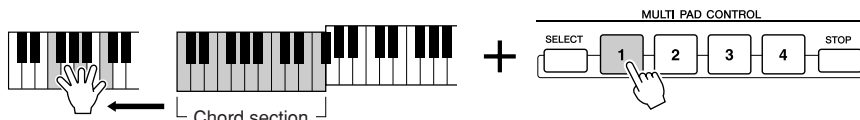

In this example, the phrase for Pad 1 will be transposed into F major before playing back. Try out other various chord types while playing the Multi Pads.

Voice Effects

Reference on pages 87, 191 →

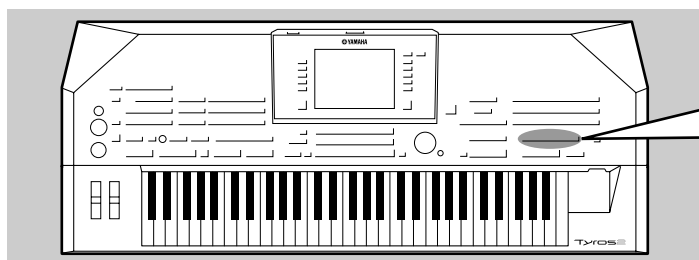

The Tyros2 features a sophisticated multi-processor effect system which can add extraordinary depth and expression to your sound. This effect system can be turned on or off by using the following buttons.

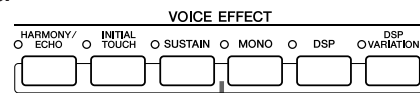

These three effect systems are applied to the currently selected keyboard part (RIGHT 1, 2, 3, or LEFT).

- **HARMONY/ECHO** See below.
- **INITIAL TOUCH** This button turns the touch response of the keyboard on or off. When OFF, the same volume is produced no matter how strongly or softly you play the keyboard.
- **SUSTAIN** When this feature is ON, all notes played on the keyboard with the UPPER part (RIGHT 1, 2, 3) have a longer sustain.
- **MONO** This determines whether the Part's Voice is played monophonically (only one note at a time) or polyphonically.
- **DSP** This button turns DSP effects on or off independently for the RIGHT 1, RIGHT 2, RIGHT 3 and LEFT parts.
- **DSP VARIATION** This button can be used to switch between variations of the DSP effect. For example, this lets you change the rotating speed (slow/fast) of the rotary speaker effect.

Applying Harmony to Your Right-hand Melody

Among the Voice Effects, Harmony is one of the most impressive. It automatically adds harmony parts to the notes you play with your right hand—immediately giving you a more full and professional sound.

- ▶ **1** Turn the [Harmony/Echo] button on.
- ▶ **2** Turn on both the [ACMP] button and [SYNC START] button (page 31) and make sure that the RIGHT 1 part is on (page 25).
- ▶ **3** Play a chord with your left hand to start the style (page 32) and play some notes in the right-hand range of the keyboard.

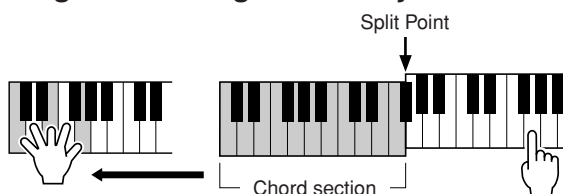

In this example, harmony notes in the scale of C major (the chord played in the left hand) are automatically added to the notes played in the right-hand range of the keyboard.

You can also use the Harmony effect with the style stopped (with the Stop Accompaniment function; page 33). Simply hold down a chord with your left hand and play a melody with your right.

Try out Harmony/Echo with some of the voices below...

Many of the voices have been automatically set to play certain Harmony/Echo types that match the particular voice. Try out some of the voices below—playing chords with your left hand and melodies with your right—and listen to the various Harmony and Echo effects.

Category	Voice	Harmony/Echo type	Category	Voice	Harmony/Echo type
Piano	Live! Grand	Standard Trio	Guitar	CrunchGuitar	RockDuet
Accordion	TuttiAccordion	Country Trio		PedalSteel	Country Duet
Strings	Live! Strings	Block	Saxophone	Moonlight	Full Chord
	ChamberStrings	4-way Open	Percussion	Vibraphone	Trill
	Harp	Strum		Timpani	Tremolo

Calling Up Ideal Setups for Your Music—Music Finder

Reference on page 171 →

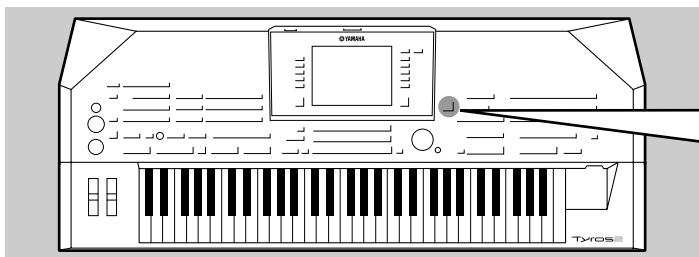

If you want to play in a certain genre of music but don't know which style and voice settings would be appropriate, the convenient Music Finder function can help you out. Simply select the desired music genre from among the "Records" that make up the Music Finder and the Tyros2 automatically makes all appropriate panel settings to let you play in that music style!

Selecting the desired music genre from the Record List

1 Press the [MUSIC FINDER] button to call up the Music Finder display.

The Music Finder display contains various "records"—each of which has pre-assigned panel settings to match the corresponding song title or music genre. Each record has the following four items.

- **MUSIC**.....Contains the song title or music genre that describes each record, letting you easily find the desired music style.
- **STYLE**.....The preset style assigned to the record.
- **BEAT**.....The time signature registered to each Record.
- **TEMPO**.....The assigned tempo setting for the record.

MUSIC	STYLE	BEAT	TEMPO
2 Nights In A Big City	40'sBigBand	4/4	90
40th Symphony	PopClassics	4/4	124
60 Second Waltz	VienneseWaltz1	3/4	240
69 Summers Long	PowerRock	4/4	130
A Boy From The Country	Bluegrass	2/4	150
A Bridge To Cross Troubled ~	PowerBallad	4/4	78
A Bright & Guiding Light	EasyListening	4/4	76
A Cozy Life In Italy	OrganBallad	4/4	88
A Day's Difference	70'sTVTheme	4/4	126
A Divorce In The Country	CountrySwing2	4/4	126
A Feeling Of Love Tonight	MovieBallad	4/4	68
A Fire Lighter	Unplugged1	4/4	118
A Great Way To Spend Toni-	Orch,JazzBallad	4/4	72
A Jolly Good Fellow	TheatreMarch	6/8	112

If necessary, press the [TAB] button to call up the "ALL" page. All the preset Records built into the Tyros2 are listed on this page.

2 Select the desired Record in the list.

Rotate the [DATA ENTRY] dial to move the cursor on the Record list. Once the desired song name or music genre is highlighted, press the [ENTER] button to call up the corresponding Music Finder setup. Keep in mind that the panel setup actually called up is the one pre-programmed as the One Touch Setting.

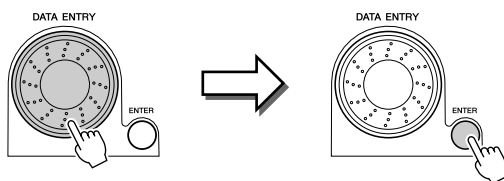

3 Play the styles.

Try it out!



Searching the Ideal Setups by Keyword

The Music Finder feature of the Tyros2 has a wide range of more than 1800 different records—making it exceptionally versatile, yet difficult to find a desired setup. That’s where the Search function comes in handy. It lets you quickly and easily find the records that you want to use.

- ▶ **1** Press the [SEARCH 1] LCD button ([I] button) on the Music Finder display to call up the Search display.

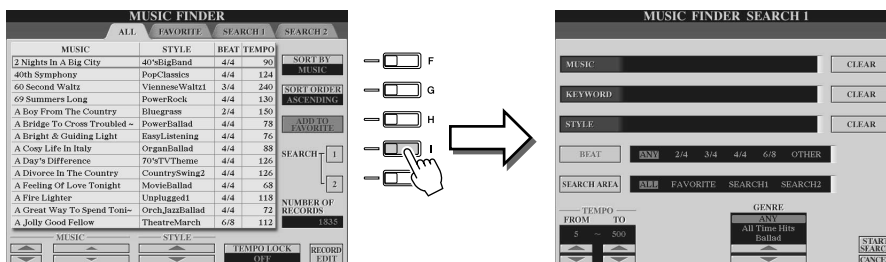

- ▶ **2** Enter the search criteria and start the search.

Press one of these buttons to call up the pop-up window for searching by music genre or keyword. Text entry is done in the same way as with file names (page 76). After entering the music genre or keyword, press the [OK] LCD button to return back to this display.

Press this button to call up the Style selection display. After selecting the desired style, press the [EXIT] button to return back to this display. This convenient function lets you find all songs that use a certain accompaniment style.

Press this button to specify the time signature for the search. Pressing the button alternates among the selections. Selecting “Any” searches through all records, regardless of the time signature.

Selects a specific location for searching. You can further narrow down your search by using the SEARCH 1 and 2 selections.

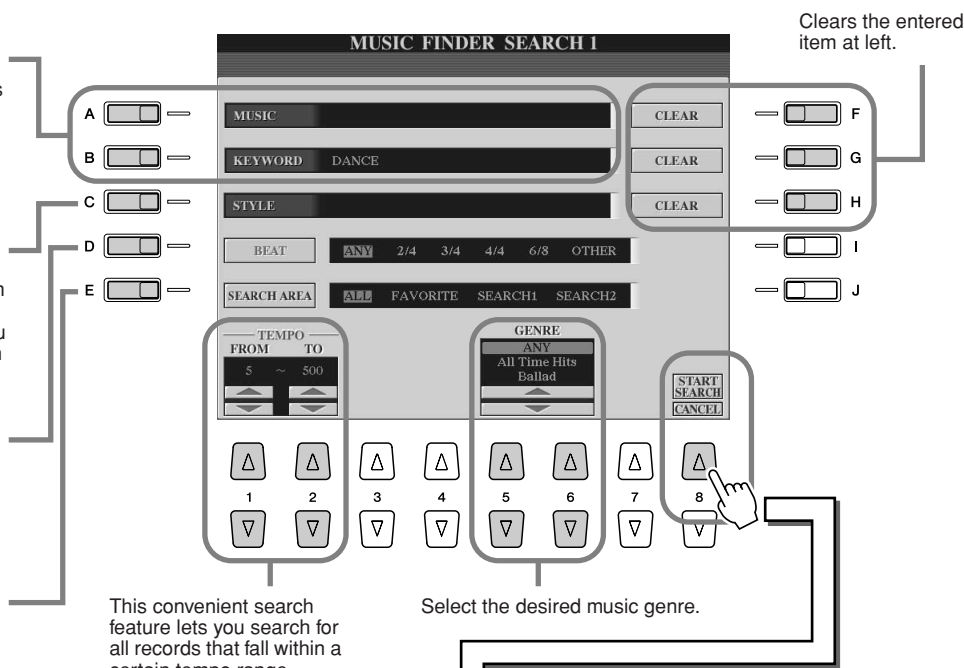

NOTE

- If you wish to further narrow down your search or search another music genre, use the SEARCH 2 display.
- Regarding relevant records that are found using the selected Style, you can obtain the same results by using the Repertoire function (page 33).



Press the [START SEARCH] LCD button to execute the search. The Search 1 display appears, showing the results of the search.

- ▶ **3** Select the desired record from the list on the SEARCH 1 display and play the music style.

Try it out!

Creating a Set of Favorite Records

As convenient as the Search function is in plumbing the depths of the Music Finder records, you may want to create a “folder” of favorite records—so you can quickly call up those styles and settings you use most often in your performance.

Press the [H] button to add the selected record to the Favorite page. (When the prompt appears, select [YES] to actually add the record.)

Press the [TAB] button to call up the FAVORITE page and confirm whether the specified record has been added.

Other convenient functions

Music Finder has a variety of other useful functions, as described below. These are available in all the Music Finder pages.

- **F** — Sort the records by each item.
- **G** — Change the order of the records (ascending or descending). The order method is determined by the sort item above.
- **H** — This deletes selected records from the Favorite page (when the Favorite page is selected). The record is deleted only from the Favorite page and not from the Music Finder.
- **I** —
- **J** — Shows the number of records of the currently displayed page.

Press this button to create a new record by editing the currently selected one. **Page 171**

Avoids changing the Tempo during style playback when selecting another record, regardless of the Tempo Hold/Reset setting in Function (page 158).

These sets of buttons are used when the Record list is sorted by STYLE. When sorting records by style name, use the up or down button to skip up or down through the style categories. Simultaneously press the up and down buttons to move the cursor to the first record.

These sets of buttons are used regardless of the sort item. Press the up or down button to move the cursor up or down and select the new record.

When sorting records by MUSIC, use the up or down button to skip up or down through the music titles alphabetically. Simultaneously press the up and down buttons to move the cursor to the first record.

Song Playback

Reference on page 112 →

You can play MIDI song data directly from the Tyros2. This includes not only the preset demo songs, but also commercially available song data as well as songs you've created with the Song Recording function (page 55) or Song Creator function (page 121). (For information on compatible song data, see page 212.)

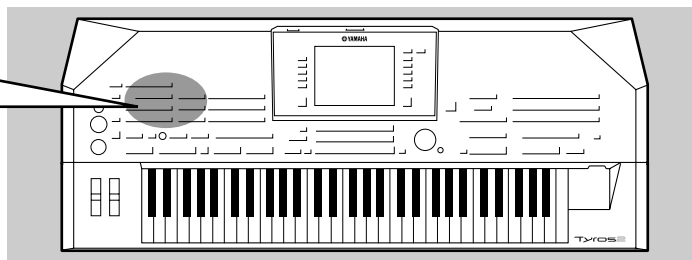

Playback of Songs in the USB Storage Device

- ▶ **1** Connect the USB storage device containing MIDI song data to the USB TO DEVICE terminal.

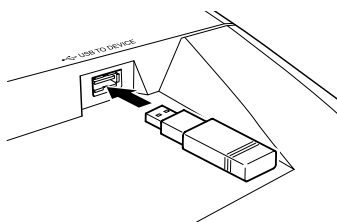

IMPORTANT

If you have connected a floppy disk drive to the USB TO DEVICE terminal and are using a floppy disk, make sure to read the section "Handling the floppy disk drive (FDD) and floppy disks" on page 231.

- ▶ **2** Press any of the SONG buttons to call up the song selection display.

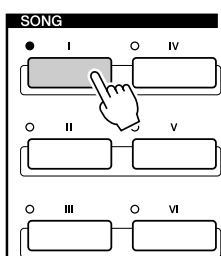

If necessary, use the [TAB] buttons to call up the USB page.

NOTE

The song selection display shown here is called the "Open/Save" display for the song. The Open/Save display actually has two different display modes: 1) a direct selection display (shown at left), and 2) a numeric input display that lets you select the voice by inputting the song number. For details, see page 77.

- ▶ **3** Select a song in the USB storage device.
Selecting a song is done in the same way as selecting a voice or style.

- ▶ **4** Press the SONG CONTROL [PLAY/PAUSE] button to start the selected song.

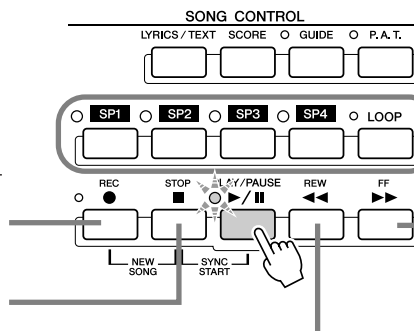

This button lets you record your keyboard performance as MIDI song data.
Page 55

During playback, you can have the song return to the top and play back again from the beginning by pressing this button. When playback is stopped, pressing this button returns the song to the beginning.

These buttons let you use markers in the song data—for easy navigation, and for setting up playback loops.
Page 45

Moves forward one measure when pressed briefly, or scrolls forward continuously (fast forward) when held.

Press this button to call up the SONG POSITION pop-up window on the LCD display.

Moves back one measure when pressed briefly, or scrolls backward continuously (fast reverse) when held.

Press this button to call up the SONG POSITION pop-up window on the LCD display.

- ▶ **5** Press the SONG CONTROL [PLAY/PAUSE] button again to stop the song.

Restrictions for protected Songs

Commercially available song data may be copy protected to prevent illegal copying or accidental erasure. They are marked by the indications at the upper left side of the file names. The indications and relevant restrictions are detailed below.

Prot. 1	Indicates Preset Songs saved to the User drive. These cannot be copied/moved/saved to external devices.
Prot. 2 Orig	Indicates Yamaha-protection-formatted Songs. These cannot be copied. These can be moved/saved only to the User drive and USB storage devices with ID.
Prot. 2 Edit	Indicates edited "Prot. 2 Orig" Songs. Make sure to save these to the same folder containing the corresponding "Prot. 2 Orig" Song. These cannot be copied. These can be moved/saved only to the User drive and USB storage devices with ID.

Note for "Prot. 2 Orig" and "Prot. 2 Edit" Song file operation

Make sure to save the "Prot. 2 Edit" Song to the same folder containing its original "Prot. 2 Orig" Song. Otherwise the "Prot. 2 Edit" Song cannot be played back. Also, if you move a "Prot. 2 Edit" Song, be sure to move its original "Prot. 2 Orig" Song to the same location (folder) at the same time.

■ Viewing Song Lyrics and Score

- When the song data contains lyric data, you can view it by using the [LYRICS/TEXT] button..... Page 47
- When you have text data containing lyrics, you can view it by using the [LYRICS/TEXT] button. Page 115
- You can also view the song score (notation) by using the [SCORE] button..... Page 50

Using Song Position Markers

Song Position markers (SP 1–SP 4) can be placed in the song data. This not only lets you navigate quickly and easily through the song data, but also lets you set up convenient playback loops—allowing you to create dynamic song arrangements “on the fly,” as you perform.

■ Jumping among song positions.....

▶ 1 Select a song and start playing back from the top of the song.

Press the [STOP] button (if necessary) and press the [PLAY/PAUSE] button.

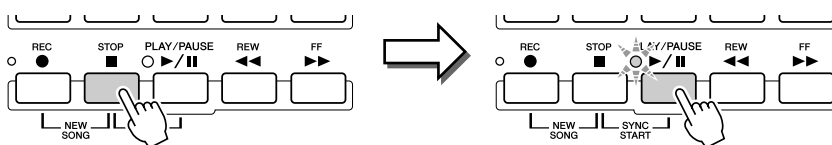

▶ 2 Enter a marker to the desired song position by double-clicking one of the [SP] buttons during playback.

As the song is playing back, double-click (press twice quickly) one of the [SP1]–[SP4] buttons at the point you wish you enter a marker. The corresponding button flashes in green, and the marker for that button is entered to the 1st beat of the appropriate measure.

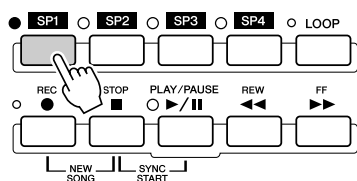

If a marker has already been entered to the button, the lamp is lit in green or red. Double-clicking on the button will set the marker to a new song position.

Continue to enter other markers in the same way. The illustration below shows an example of how all of the markers may be entered in a song.



NOTE

- You also can enter the marker by stopping the song at the desired position and double-clicking any of the [SP1]–[SP4] buttons. Whether executed during playback or while playback is stopped, the marker is always entered at the top of the current measure.

CAUTION

- To store your marker settings, save the song data to the User drive, USB drive, or HD drive (if an optional hard disk has been installed). Keep in mind that the marker settings will be lost if you select another song or turn the power off without saving the song data. For details on saving song data, see step #8 on page 56.

▶ **3** Stop song playback.

▶ **4** Now that you've entered markers in step #2 above, *Try it out!* try using them to jump around in the song and navigate among the song positions.

● Jumping to a marker, then starting playback

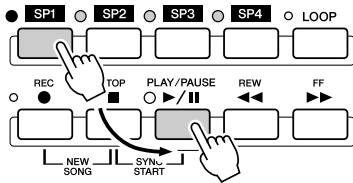

In this example, song playback starts from the top of the measure assigned to the [SP1] button (in step #2 above).

● Jumping to a marker during playback

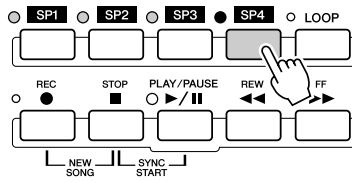

In this example, song playback continues to the end of the current measure, then jumps to the selected marker—the top of the measure assigned to the [SP4] button (in step #2 above). You can cancel the jump by pressing the same button ([SP4]) again before the actual jump. (Be careful not to double-click the button.)

NOTE

• Be careful to press the [SP1]–[SP4] button only once when jumping among markers. Pressing a button twice (double-clicking) will change the marker position.

▶ **5** Stop song playback.

■ Using markers in loop playback.....

Try using the markers you registered in step #2 above to play back the separate “sections” of the song in loops.

▶ **1** Go to the top of the song to which you've entered the markers and start it.

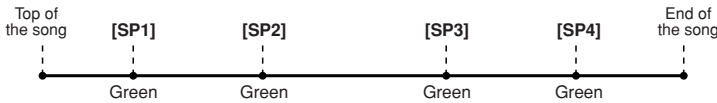

The [SP1] button changes from green to red after the [SP1] point has played back.



▶ **2** Turn the [LOOP] button on after passing the [SP1] point.

The song plays back up to the [SP2] point, then goes back to [SP1] and loops between the two points (as shown).

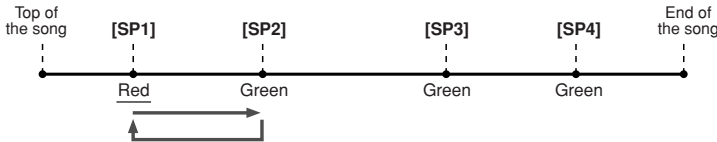

▶ **3** Turn the [LOOP] button off by pressing it again.

The loop in step #2 above continues indefinitely until you turn the [LOOP] button off. When you turn it off, playback continues past the [SP2] point and on to [SP3]. (The [SP2] button changes from green to red after the [SP2] point is passed.)

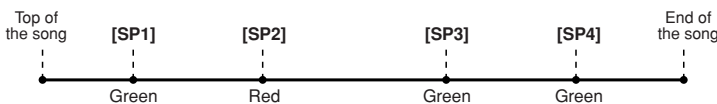

▶ **4** Turn the [LOOP] button on again before reaching the [SP3] point.

Turning the [LOOP] button on again here starts a new loop—this time between the [SP2] and [SP3] points (as shown).

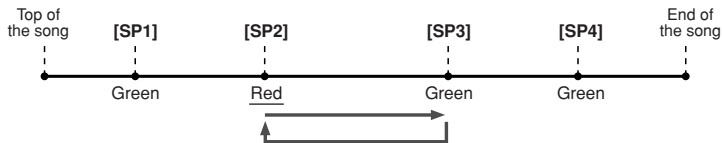

▶ **5** Continue looping the remaining “sections” of the song ([SP2]–[SP3] and [SP3]–end) in the same way, repeating steps #3 and #4 above.

▶ **6** Stop song playback.

Adjusting the Volume Balance between the Song and the Keyboard

Press the [BALANCE] button so that the mixer window (pop-up) appears at the bottom of the LCD display (page 36). You can adjust the volume balance between song playback and your right-hand keyboard performance by using LCD buttons [1], [5], [6], [7], and [8].

Turning Song Parts On/Off

Press the [CHANNEL ON/OFF] button so that the pop-up window appears at the bottom of the LCD display. You can turn each part (channel) on or off by using the lower LCD [1]–[8] buttons during song playback.

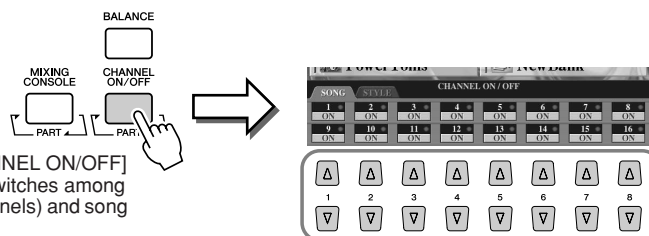

Pressing the [CHANNEL ON/OFF] button repeatedly switches among the style parts (channels) and song channels.

Press the LCD button corresponding to the part (channel) you wish to turn on or off.

Singing with a Connected Microphone

Reference on page 175 →

The Tyros2 is equipped with an input jack, letting you connect another audio source—such as a microphone for your voice, an electric guitar, or a CD player—and mix it with the sounds of the Tyros2. The fun doesn't stop there, however. With the Vocal Harmony feature (page 48), you can also apply various harmony and echo effects to your voice or guitar playing. Or use the Tyros2 for karaoke and sing-alongs—applying various DSP effects to your voice, as you sing with the auto accompaniment or song playback.

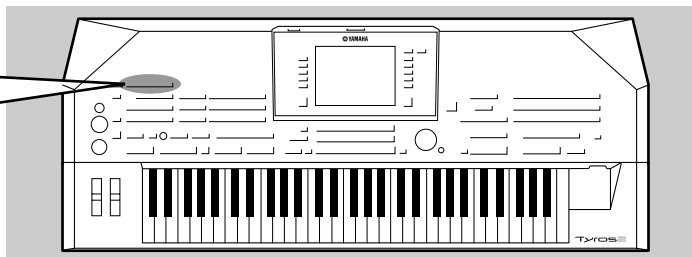

Connecting a microphone

- ▶ **1** Set the [TRIM] control on the rear panel and the [INPUT VOLUME] on the front panel both to “MIN.”

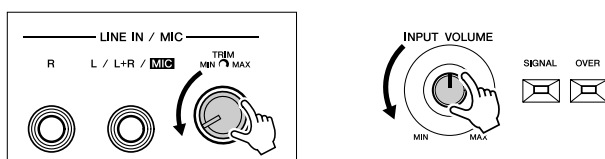

NOTE

- To avoid possible feedback or other interference, separate the microphone from the speakers as much as possible.

- ▶ **2** Connect a microphone to the L/L+R/MIC jack.

The L/L+R/MIC jack accepts 1/4" phone plugs.

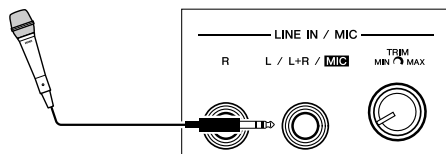

IMPORTANT

- Since the L/L+R/MIC jack is highly sensitive, it may pick up and produce noise when nothing is connected. To avoid this, always set the INPUT VOLUME to minimum when nothing is connected to the L/L+R/MIC jack.

- ▶ **3** Turn the power on.

- ▶ **4** Adjust the [TRIM] control on the rear panel and the [INPUT VOLUME] on the front panel while singing into the microphone.

- Since the input level from the microphone may be low, set the [TRIM] control close to “MAX.”
- Adjust the controls while checking the OVER and SIGNAL lamps.

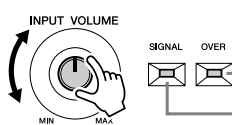
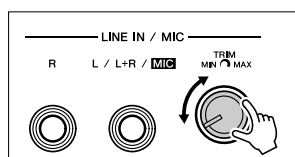

The OVER lamp lights when the input level is too high. Make sure to adjust the INPUT VOLUME so that this lamp does not light.

The SIGNAL lamp lights to indicate that an audio signal is being received.

NOTE

- Make sure to set the [INPUT VOLUME] to “MIN” before performing the following operations.
- Connecting a microphone to the Tyros2
- Removing a microphone from the Tyros2
- Turning the Tyros2's power off
- You may find that microphone sound is distorted, even though the OVER lamp is not lit. If so, try setting the [TRIM] control on the rear panel close to “MIN” and adjusting the [INPUT VOLUME] control on the front panel until the level is appropriate.
- Since the input level from the mixer or audio equipment may be high, set the [TRIM] control on the rear panel close to “MIN.”
- Keep in mind that setting the [TRIM] control to “MIN” does not set the volume to zero (no sound). To set the volume to zero, turn the [INPUT VOLUME] control to “MIN.”

Singing Along with Lyrics

Try playing a song that contains lyric data, then sing along with it using the connected microphone.

- ▶ **1** Select a song that contains lyric data (page 44).
- ▶ **2** Press the [LYRICS/TEXT] button to call up the Lyrics display.

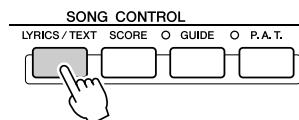

- ▶ **3** Turn the Effect for the microphone sound on, if desired.
- ▶ **4** Start song playback.
- ▶ **5** Sing the song while viewing the lyrics on the display.
- ▶ **6** Stop the song.

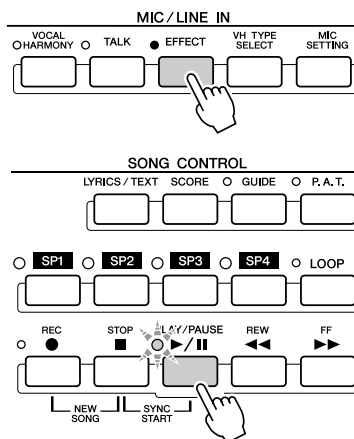

NOTE

The lyrics indicated on the LCD display can be output via the [RGB OUT]/[VIDEO OUT] terminal. You can have only the lyrics of the song output via the terminal, even when another display is called up. This lets you select other displays and still have the lyrics shown on the monitor. For details, see page 188.

Applying harmony to your voice

Use the sophisticated Vocal Harmony function to automatically apply harmony to your voice as you sing into the connected microphone.

- ▶ **1** Turn Vocal Harmony on.
- ▶ **2** Press the [VH TYPE SELECT] button to call up the Vocal Harmony type selection display and select one of the types.

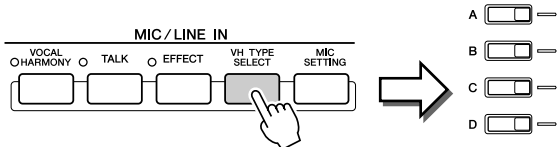
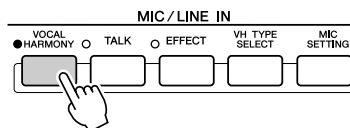

For this example, "JazzSisters" is selected.

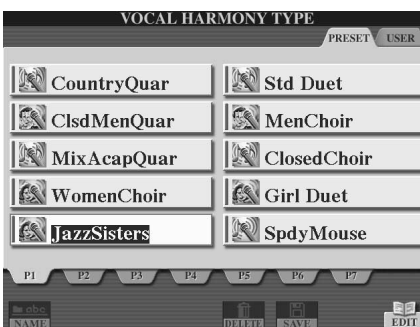

- ▶ **3** Turn the [ACMP] button on.
- ▶ **4** Play and hold down chords in the left-hand section of the keyboard as you sing along with the accompaniment.

Try it out!

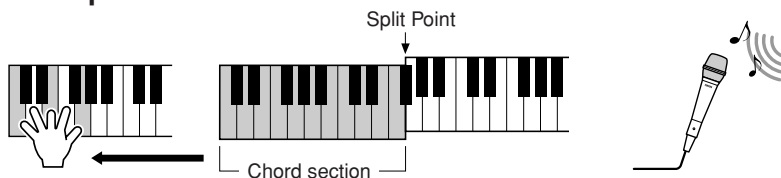

The harmony is applied to your voice according to the chord you play. Try out various chords.

NOTE

If you experience distorted or out-of-tune sound from the Vocal Harmony feature, your vocal microphone may be picking up extraneous sounds (other than your voice)—the Style playback sound from the Tyros2, for example. In particular, bass sounds can cause mistracking of the Vocal Harmony feature. The solution to this problem is to ensure that as little extraneous sound as possible is picked up by your vocal microphone:

- Sing as closely to the microphone as possible.
- Use a uni-directional microphone.
- Turn down the MASTER VOLUME, STYLE volume or SONG volume control.

Vocal Harmony Chords

Vocal Harmony is triggered by the chords you play. In the example instructions above, the chords played in the style chord section of the keyboard are used to trigger the Vocal Harmony. Depending on the Harmony Mode setting and the particular application, different chords can be used to trigger Vocal Harmony (as listed below). For details, see page 178.

Chords that trigger Vocal Harmony	Required settings (Harmony mode)
Chords specified in the style chord section of the keyboard	CHORDAL
Chords specified in the Upper part (RIGHT 1-3) section of the keyboard	VOCODER
Chords specified in the Lower part (LEFT) section of the keyboard	VOCODER
Chord data contained in an XF song	CHORDAL
Detected chords based on notes contained in the song data	CHORDAL, VOCODER

Keyboard and Vocal Practice using the Guide function

The educational and fun Guide features make it easy to learn new music. They indicate the notes you should play, when you should play them, and how long you should hold them down. What's more, with a connected microphone, the Tyros2 makes sing-alongs more fun and interesting as well. Here, you'll also learn how to practice music effectively using the Song Score function of the Guide features, reading the music score shown in the LCD.

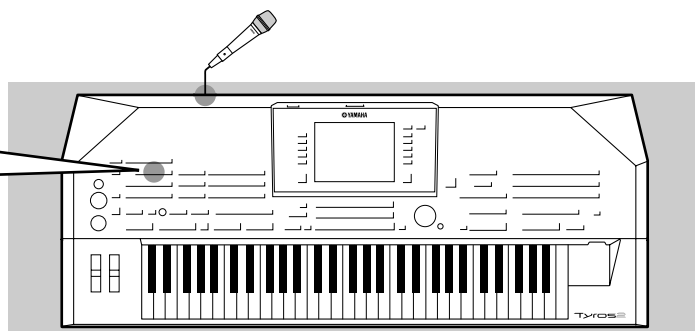

Selecting a Guide menu

Call up the SONG SETTING display by following the procedure below and select a Guide menu.

MENU

FUNCTION VOICE CREATOR DIGITAL RECORDING

SONG STYLE MULTI PAD

↓

FUNCTION MENU

A	MASTER TUNE/ SCALE TUNE	HARMONY/ECHO
B	SONG SETTING	SCREEN OUT
C	STYLE SETTING/ SPLIT POINT/ CHORD FINGERING	MIDI
D	CONTROLLER	UTILITY
E	REGIST. SEQUENCE/ FREEZE/VOICE SET	

Select one of the four Guide menus by using the LCD [A] and [B] buttons. For details about the four menus, see below.

SONG SETTING

GUIDE MODE

Follow Lights
Any Key
Karao-Key
Vocal CueTIME

SINGLE ALL RANDOM REPEAT MODE

SURRENDER ALL REPEAT FOLDER

ON PHRASE MARK REPEAT

CHANNEL SETTING

LEFT CH	RIGHT CH	AUTO CH SET	LYRICS LANGUAGE	QUICK START
OFF	OFF	ON	INTERNATIONAL	ON
1	2	OFF	JAPANESE	OFF

1 2 3 4 5 6 7 8

↓

Since the commercially available song data may be already programmed with fixed channels for the Guide features, set this parameter to ON.

■ Guide menu for keyboard practice

- **Follow Lights** When this is selected, song playback pauses, waiting for you to play the notes correctly. When you play the correct notes, song playback continues. Follow Lights was developed for the Yamaha Clavinova series. This function is used for practicing purposes, with built-in lamps on the keyboard indicating the notes to be played. Even though the Tyros2 does not have these lamps, you can use the same function by following the indications in the displayed notation with the Song Score function.
- **Any Key** With this function, song playback pauses and waits for you to play any key. When you play the keyboard in correct time with the music (any key is fine), song playback continues. (For this function, the notes of the keyboard do not sound.)

■ Guide menu for sing-along

- **Karao-Key** This function lets you control the song and accompaniment playback with just one finger, while you sing along. Simply play a key on the keyboard in time with music (any key is fine) and the accompaniment parts of the song follow your playing. (For this function, the notes of the keyboard do not sound.)
- **Vocal Cue Time** With this function, song playback pauses, waiting for you to sing the notes correctly. When you sing the correct notes, song playback continues.

Keyboard Practice using "Follow Lights"

- ▶ **1** Select the desired song for practicing the keyboard (page 43).
- ▶ **2** Call up the SONG SETTING display by following the procedure described on the previous page and select "Follow Lights." If necessary, specify the channel settings.
- ▶ **3** Call up the Song Score display by pressing the [SCORE] button.

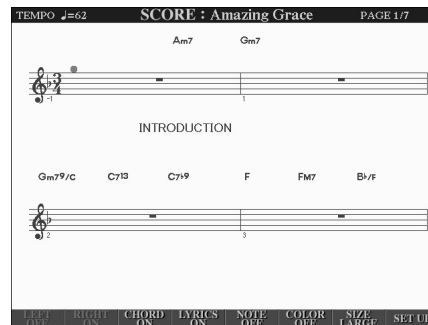
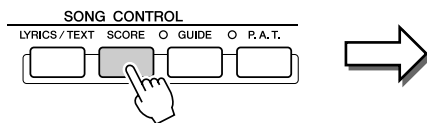

- ▶ **4** Turn the [GUIDE] button on.

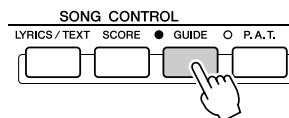

- ▶ **5** Start song playback.

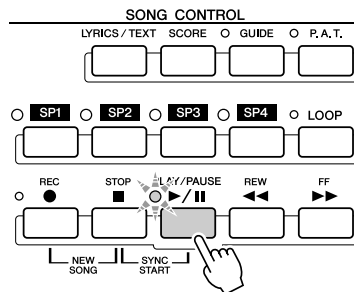

- ▶ **6** Song playback automatically pauses, indicating that you should play a certain melody note.

Try it out!

Look at the notation in the LCD to see which note to play.

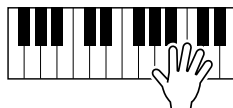

- ▶ **7** To stop the practice session in the middle of the song, stop song playback.

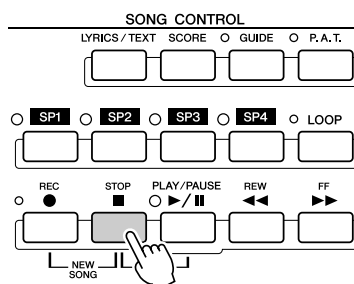

Vocal Practice using "Vocal Cue Time"

- ▶ **1** Connect a microphone to the Tyros2 (page 47).
- ▶ **2** Select the desired song for singing.
- ▶ **3** Call up the SONG SETTING display by following the procedure described on page 49 and select "Vocal Cue TIME." If necessary, specify the channel settings.
- ▶ **4** Call up the Song Score display by pressing the [SCORE] button.

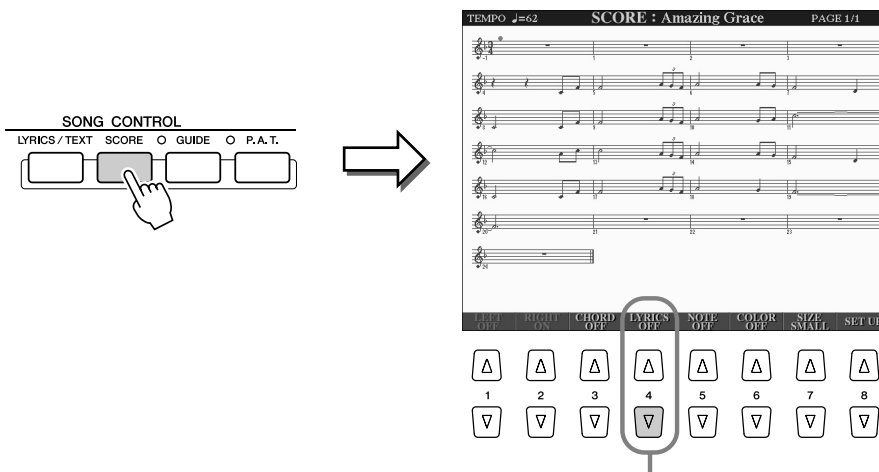

Press the lower [4] button so that the lyrics appear on the score.

- ▶ **5** Turn the [GUIDE] button on.
- ▶ **6** Start song playback.

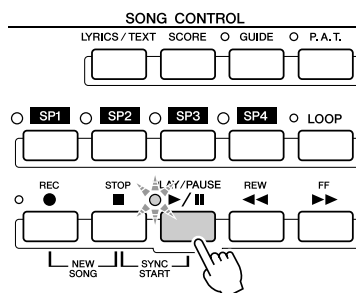
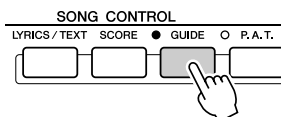

- ▶ **7** Song playback automatically pauses, indicating that you should sing a certain melody note.

Try it out!

Look at the notation in the LCD to see which note to sing.

- ▶ **8** To stop the practice session in the middle of the song, stop song playback.

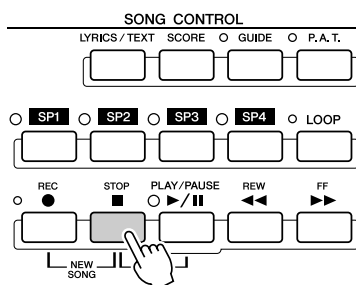

Saving and Recalling Custom Panel Setups—Registration Memory

Reference on page 173 →

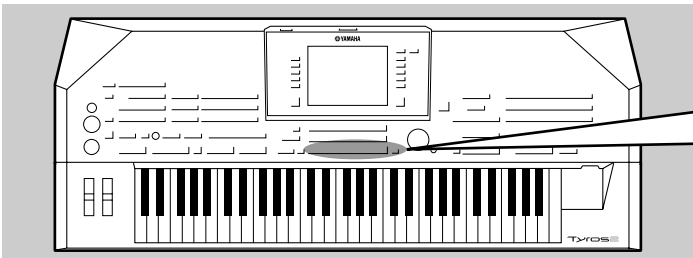

Since the Tyros2 is such a sophisticated instrument with such a variety of controls and functions—voice, style, and effect settings, just to name a few—it may be difficult to get a handle on them all. This is where the convenient Registration Memory can help. It allows you to save virtually all panel settings to a Registration Memory setting, and then instantly recall your custom panel settings by pressing a single button.

NOTE

• For a list of Registration Memory setup parameters, refer to the separate Data List.

Saving your Panel Setups to a Registration Memory

- ▶ **1** Set up the panel controls (such as voice, style, effects, and so on) as desired.
- ▶ **2** Press the [MEMORY] button in the REGISTRATION MEMORY section.

NOTE

• When a checkmark is entered to the SONG box, the current path (currently selected folder) of the song file can be memorized to Registration Memory.

You can determine whether the settings are to be memorized (on) or not (off) for each parameter group. Enter checkmarks only to those parameter groups you want to be memorized.

Moves the cursor to the parameter group. You can move the cursor by using the [DATA ENTRY] dial.

Legend:

- F
- G
- H
- I — Cancels the registration and returns to the previous display.
- J

— MARK
▲ ON
▼ OFF

— — Enters a checkmark to the selected box (parameter group).

— — Removes the checkmark from the selected box (parameter group).

- ▶ **3** Press the numbered [REGISTRATION MEMORY] button to which you wish to memorize the panel setup.

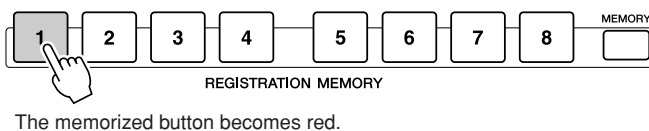

- ▶ **4** Memorize various panel setups to other buttons by repeating steps #1–#3.

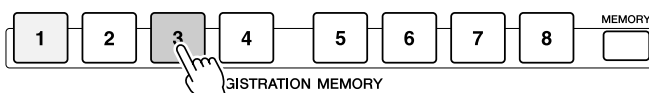

The button to which the panel setup has just been memorized lights red and the button to which the panel setup was previously memorized lights green—the lit buttons indicating that each contains panel setup data.

- ▶ **5** Referring to the instructions on page 53, save the eight memorized buttons as a single Registration Memory bank to the User drive (page 29).

CAUTION

• Any panel setup previously memorized to the selected REGISTRATION MEMORY button (indicator is green or red) will be erased and replaced by the new settings.

NOTE

• To delete all eight current panel setups, turn the [POWER] button ON while holding the B6 key (right-most B key on the keyboard).

Saving your Registration Memory to the User drive

The Tyros2 allows you to save all eight memorized buttons as a single Registration Memory bank. You can save as many Registration Memory banks as you want, up to the internal memory capacity of the Tyros2.

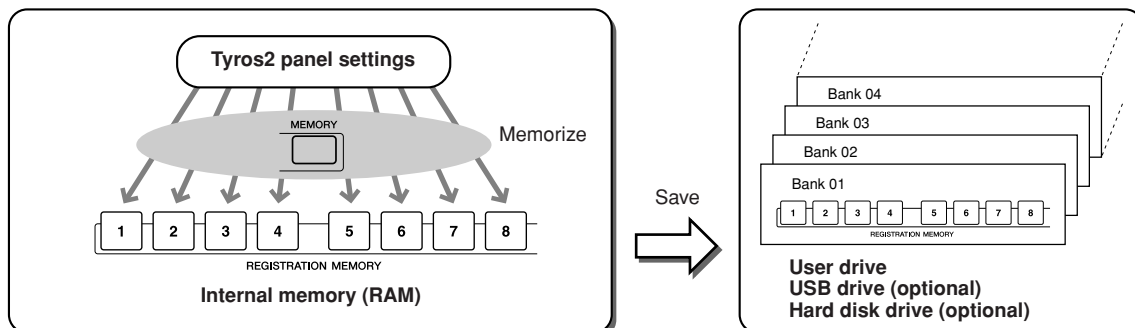

For future recall, you'll need to save your Registration Memory settings to the drive. In these example instructions, we'll save them to the User drive.

▶ **1 Memorize your custom panel settings to each of the eight Registration Memory buttons, as described on page 52.**

It is not necessary to memorize settings for all eight buttons. If a button has no memorized data, it is unlit.

▶ **2 Press both REGIST BANK [-] [+] buttons simultaneously to call up the Registration Memory Bank selection (Open/Save) display.**

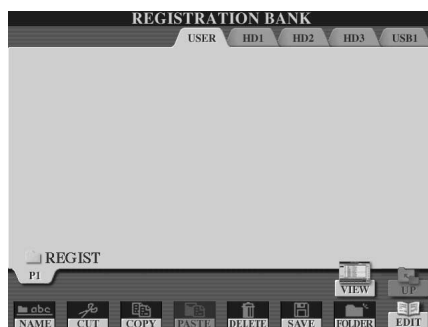
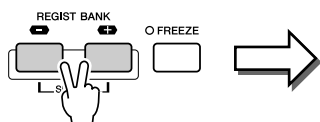

NOTE

• You can also call up the Registration Memory Bank selection display from the Main display.

NOTE

• When you select several Registration Banks in succession, an error message may appear. If this happens, turn the power of the instrument off and on again.

▶ **3 If desired, call up the Registration Edit display and make other settings for Registration Memory, such as naming.**

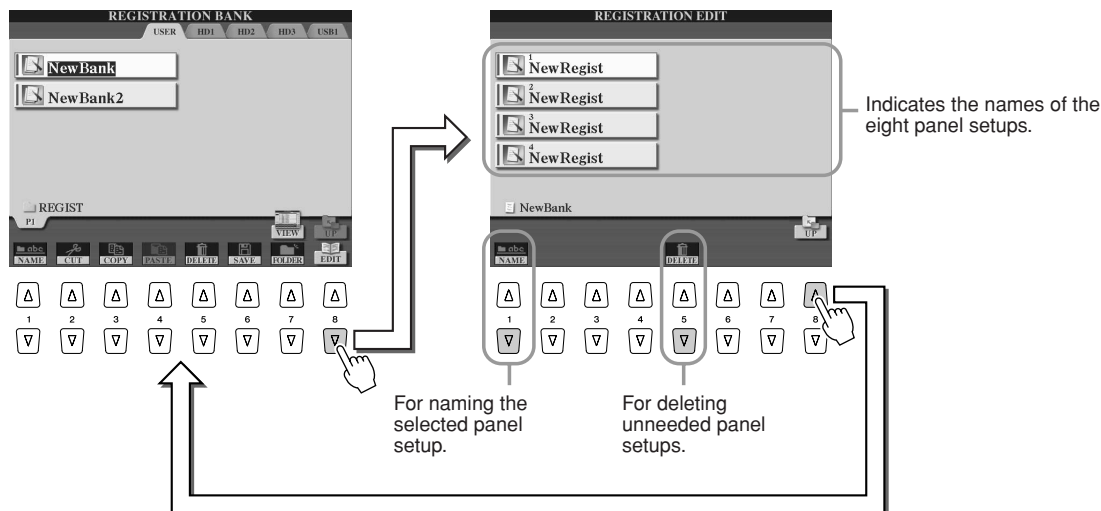

- ▶ **4** Go back to the Registration Memory Bank selection (Open/Save) display and execute the Save operation.

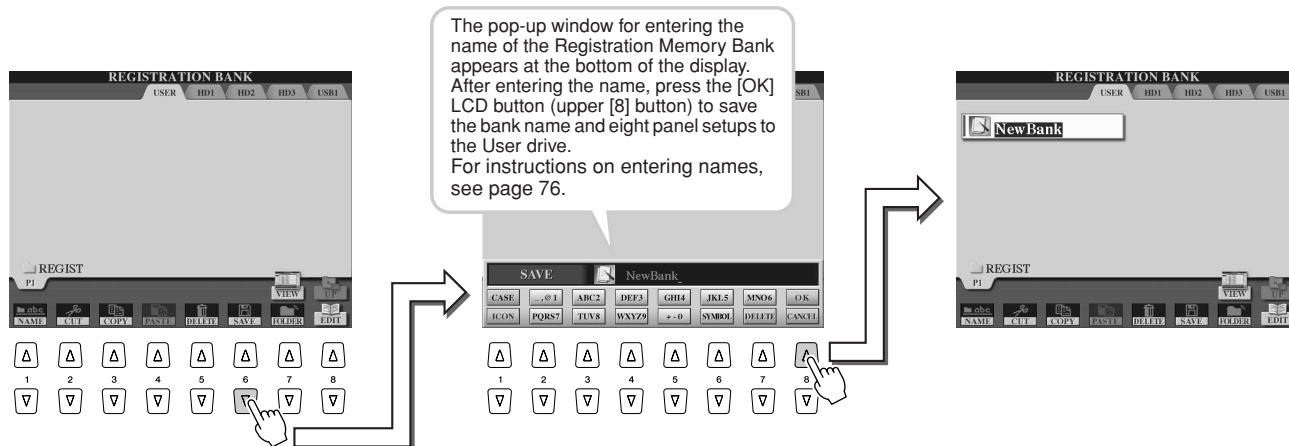

Recalling a Registration Memory Setup

- ▶ **1** Press both REGIST BANK [-] [+] buttons simultaneously to call up the Registration Memory Bank selection display.

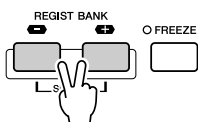

- ▶ **2** Select a Registration Memory bank.

Selecting a Registration Memory bank is done in the same way as selecting a voice (page 25) or style (page 31).

Once you've selected a Bank, you can select previous/subsequent Banks in the same folder level by using the [-]/[+] buttons, even when a display other than the Registration Memory bank display is shown.

- ▶ **3** Press one of the green-lit numbered buttons in the Registration Memory section.

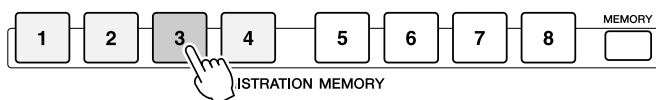

Confirm whether the correct panel settings have been called up or not.

NOTE

- When an audio song recorded by the Hard Disk Recorder is registered, the song may take a few moments to load.

■ Leaving certain parameters unchanged by Registration Memory

—Freeze functionpage 173

Registration Memory lets you recall all the Tyros2 panel settings you made with a single button press. However, there may be times that you want certain parameters and settings to remain the same, even when changing Registration Memory presets. For example, you may want to switch voices or effect settings while keeping the same accompaniment style. This is where the Freeze function comes in handy. It lets you maintain the settings of certain parameter groups and leave them unchanged, even when selecting other Registration Memory buttons.

- 1** Select the parameter group you want left unchanged or “frozen” (page 173).
- 2** Turn the [FREEZE] button on.
- 3** Change the Registration Memory number.

■ Calling up Registration Memory numbers in order

—Registration Sequencepage 173

As convenient as the Registration Memory buttons are, there may be times during a performance when you want to quickly switch between settings—without having to take your hands from the keyboard. By assigning a footswitch to control Registration Sequence, you can use your foot to step through the Registration Memory presets—in the order you've specified.

Recording Your Performances and Creating Songs—Song Recording

Reference on page 121 →

The powerful and easy-to-use Song Creator feature lets you record your own keyboard performances to the user drive, optional external devices, or the optionally installed hard disk. With multiple channels for recording, comprehensive editing features, plus the use of the style and the Multi Pads, you can record complex, fully orchestrated pieces of music in any music style or arrangement—from solo piano and church organ to rock band, big band, Latin ensemble, and even a full symphony orchestra—quickly, easily and all by yourself!

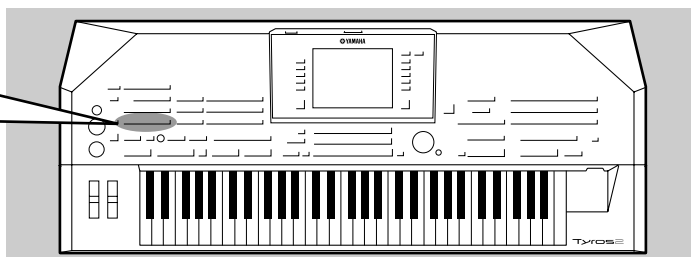

- **Quick Recording**
With this method, you can quickly and easily record a song, without having to make detailed settings.
- **Multi Recording**
With this method, you can record data to each channel independently, one by one, until you have a finished multi-channel song. This method also lets you record several channels simultaneously. To use this, set which part (Right 1–3, LEFT, Multi Pad, each part of the selected style, etc) is assigned to each MIDI channel before recording.

■ Memory operations in Song Recording

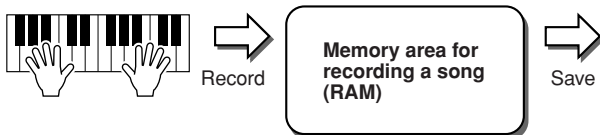

Load a song to be recorded/edited to this area.

- **When creating a new song:**
Load an empty song data to this memory area by pressing the [REC] button and the [STOP] button simultaneously.
- **When editing/re-recording the already recorded song:**
Load the song data to this memory area by selecting the desired song saved to the USER/USB/HD (optional) drives.

Memory drives for saving the recorded song

- User drive
- USB drive (optional)
- Hard disk drive (optional)



Quick Recording

▶ **1** Press the SONG CONTROL [REC] button and the [STOP] button simultaneously to prepare a blank song (“New Song”) to the Memory area for recording (shown above).

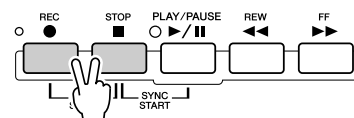

▶ **2** Press the [REC] button to enter the Song Record mode. The [REC] button and the [PLAY/PAUSE] button flash.

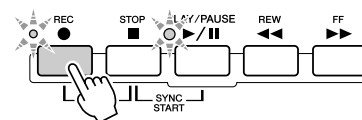

▶ **3** Make the desired panel settings for your keyboard performance. Below are some important things you should or may want to do before recording:

- Check the on/off status of each keyboard part (RIGHT 1, RIGHT 2, RIGHT 3, LEFT). pages 25, 26, 27
- Check the voice of each keyboard part (RIGHT 1, RIGHT 2, RIGHT 3, LEFT). pages 25, 26, 27
- Set the desired tempo. page 154
- Determine the time signature (beat) by selecting a style (even when you do not use a style). page 31
- Turn the [ACMP] and [SYNC START] button on if you wish to use style playback. page 31
- Make the desired panel settings using One Touch Setting, if you want to use style playback. page 36
- Check whether the selected style is appropriate or not. If necessary, select the desired style. page 31
- Check whether the selected Multi Pad Bank is appropriate or not. If necessary, select the desired bank. page 38
- Turn on [HARMONY/ECHO] if desired. page 39
- Press one of the REGISTRATION MEMORY buttons if desired. page 54

▶ 4 Start recording.

Try it out!

The SONG CONTROL [REC] button (that flashes before recording) lights continuously after recording starts. Below are details on how recording can be started.

● **Recording starts as soon as you play a key on the keyboard.**

- When turning the [ACMP] and the [SYNC START] on, style playback and recording start simultaneously as soon as a chord is played in the style chord section of the keyboard (the left side of the split point).
- When turning the [ACMP] on and the [SYNC START] off, recording starts as soon as a chord is played in the style chord section of the keyboard (the left side of the split point) with the Stop Accompaniment (page 33).

● **Recording starts by pressing the SONG CONTROL [PLAY/PAUSE] button.**

If you start recording in this way, “empty” data is recorded until you play a note on the keyboard. This is useful for creating a measure or two of silence at the top of a song. It can also be used for starting a song with a short one- or two-beat pick-up or lead-in.

- The rhythm parts (channels) of style playback and recording start simultaneously by pressing the STYLE CONTROL [START/STOP] button.

● **Multi Pad playback and recording start simultaneously as soon as you press any of the Multi Pads.**

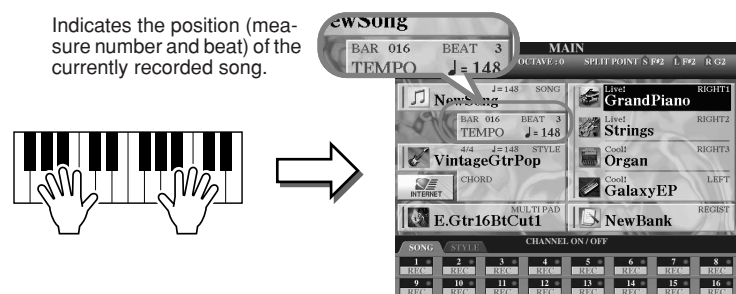

Indicates the position (measure number and beat) of the currently recorded song.

▶ 5 Press the [REC] button to stop recording.

▶ 6 Listen to your newly recorded performance.

Press the [STOP] button so that the song playback position returns back to the top and press the SONG CONTROL [PLAY/PAUSE] button.

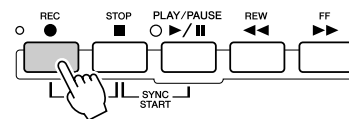
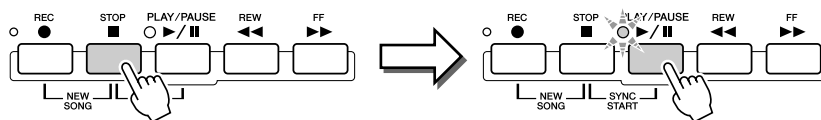

▶ 7 If necessary, re-record a specific section of the recorded song or record an additional section to the end of the recorded song.

Try it out!

Repeat steps #2–#6 above. You can selectively re-record parts of the song by starting recording in the middle of the song and stopping it when desired, or you can record continuously all the way to the end of the song.

▶ 8 Make sure to save the song data to the USER or USB drive when recording is completed.

Call up the USER or USB page of the Song selection (Open/Save) display by pressing one of the SONG buttons and execute the save.

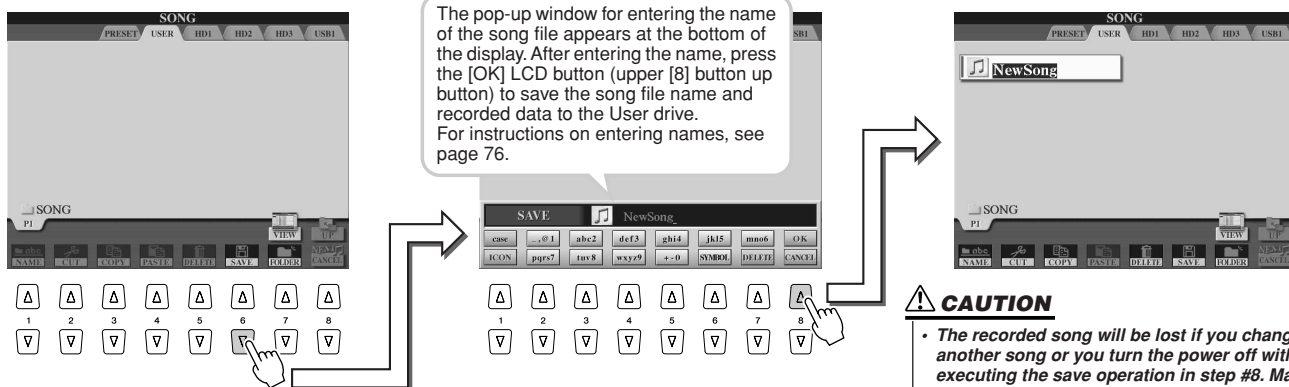

The pop-up window for entering the name of the song file appears at the bottom of the display. After entering the name, press the [OK] LCD button (upper [8] button up button) to save the song file name and recorded data to the User drive. For instructions on entering names, see page 76.

CAUTION

- The recorded song will be lost if you change to another song or you turn the power off without executing the save operation in step #8. Make sure to execute the save operation in step #8.

■ One song—sixteen MIDI channels

On the Tyros2, a single song can contain separate data for up to sixteen MIDI channels. When recording your own performance, you'll need to assign each part you play to a separate MIDI channel.

With Quick Recording (on the previous page), the Tyros2 takes care of this chore for you—letting you record a song without having to worry about which part goes to which channel. However, you'll increase your understanding of the recording process and gain greater flexibility and control by reading through the sections below—which cover recording rules and characteristics, and show you how to use Multi Recording as well as re-record an existing Quick Recording song.

● Default MIDI channel/part assignments

MIDI channel recorded to a song	Default part when recording a new song from scratch	
1	RIGHT 1	Keyboard parts
2	LEFT	
3	RIGHT 2	
4	RIGHT 3	
5	MULTI PAD 1	Multi Pads
6	MULTI PAD 2	
7	MULTI PAD 3	
8	MULTI PAD 4	
9	RHYTHM 1	Style parts
10	RHYTHM 2	
11	BASS	
12	CHORD 1	
13	CHORD 2	
14	PAD	
15	PHRASE 1	
16	PHRASE 2	

● Recording method and default part settings

	Quick Recording	Multi Recording
When recording a new song:	All channels are automatically assigned for recording, with each channel assigned a specific part. (See chart at left.)	Channels to be recorded must be enabled for recording manually. However, parts are automatically assigned to MIDI channels, as shown in the chart at left.
When re-recording an already recorded song:	The channel/part assignments made in the original recording are maintained.	Channels to be recorded must be enabled for recording manually. The channel/part assignments made in the original recording are maintained.

NOTE

- You can change channel/part assignments from the defaults above before actually recording. More specifically, even after entering the Record mode (step #2 below) via Quick Recording, you can still manually enable recording channels and set channel/part assignments via Multi Recording.

Multi Recording

- 1 Press the SONG CONTROL [REC] button and the [STOP] button simultaneously to prepare a blank song ("New Song") to the Memory area for recording (shown above).

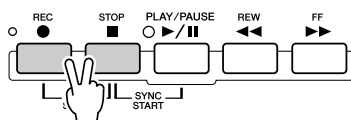

- 2 While holding the [REC] button, select the channel to be recorded and assign the part to the selected channel on the pop-up window that appears at the bottom of the LCD display.

Here, set channel 1 to "REC."

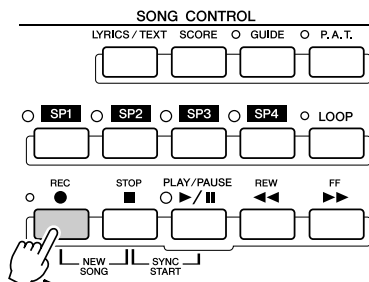

Assign the part to the channel set to REC.



While holding the [REC] button...
Set the desired channel to REC.

* Select the channel to be recorded and assign the part to the selected channel.

- ▶ **3** Make the desired panel settings for your keyboard performance. (Refer to the list of possible settings in step #3 of Quick Recording above.)

▶ **4** Start recording.

Try it out!

Recording is started in the same way as in Quick Recording.



- ▶ **5** Press the [REC] button to stop recording.

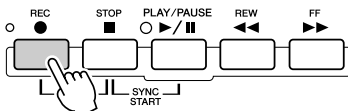

- ▶ **6** Listen to your newly recorded performance.

Press the [STOP] button so that the song playback position returns back to the top, then press the SONG CONTROL [PLAY/PAUSE] button.

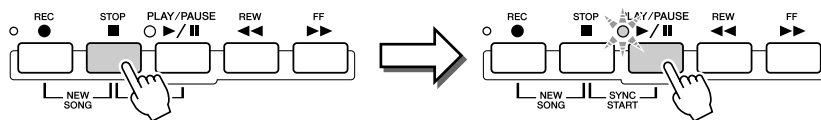

▶ **7** If desired, record another channel.

Try it out!

Repeat steps #2–#6 above.

- ▶ **8** Make sure to save the song data to the USER or USB drive when recording is completed.

Call up the USER or USB page of the Song selection (Open/Save) display and execute the save. For details, see step #8 on page 56.

NOTE

- When recording without style playback, using the Metronome function (page 193) can make your recording sessions much more efficient.

CAUTION

- The recorded song will be lost if you change another song or you turn the power off without executing the save operation in step #8. Make sure to execute the save operation in step #8.

■ **Re-recording or editing the already-recorded song**.....

Here in the “Quick Guide,” you’ve learned how to create a new song by recording. The following features of the Song Creator function allow you to re-record or edit the already-recorded song.

- Re-recording a specific section of the already-recorded song (Punch In/Out) Page 121
- Editing the recorded data for each channel
 - Quantizing, or aligning the timing Page 123
 - Deleting the data of the specified channel Page 123
 - Mixing (Merging) the data of the specified two channels Page 124
 - Transposing the recorded note data of each channel Page 124
 - Initial settings such as voice, volume, tempo and so on Page 124
- Editing the chord data by using the Event List..... Page 125
- Editing the channel data by using the Event List..... Page 127
- Editing the System Exclusive message data by using the Event List..... Page 133
- Editing the lyric data by using the Event List Page 133

Recording Audio to the Tyros2—Hard Disk Recorder

Reference on page 135 ➔

This method of recording is fundamentally different from the recording of your performance as explained on page 55. In that section, you learned how to record MIDI data. Here, you'll learn how to record the audio directly to an installed hard disk drive—for pristine, absolutely noise-free audio quality. Moreover, you'll be able to record your voice, a guitar or other acoustic and electric instruments. The recording is a simple stereo file, but you can freely overdub additional parts as desired. If you have a computer and audio editing software, you can also edit the sound file as needed, and then re-import it to the Tyros2.

The Tyros2 allows you to record audio files from the following sources:

- The internal sound of the Tyros2.
- Input from a microphone, guitar or other instrument (via the LINE IN/MIC jacks).
- Input from another audio device, such as a CD player, MP3 player or the like (via the LINE IN/MIC jacks).

You can record two of these sources at the same time—for example, the internal Tyros2 sound mixed with the microphone input—letting you record both your keyboard performance and singing simultaneously.

The recorded data using this function is saved as:

- Stereo Wave data (Here, “Wave” refers to WAV format.)
- 44.1 kHz sample rate
- 16-bit resolution

Recording the Sound of the Tyros2

In this section, you'll play the keyboard and record the sound of the Tyros2 to the Hard Disk Recorder. You can record a maximum of 80 minutes to one audio song.

▶ 1 Select a voice for the RIGHT 1 part.

For instructions on selecting a voice, see page 25.

▶ 2 Press the HARD DISK RECORDER [SETTING] button to call up the Audio Setting display.

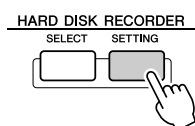

If the Volume page above is not selected, use the [TAB] buttons to call it up.

▶ 3 Play the keyboard and check the signal on the REC MONITOR meters.

Strictly speaking, this step is not necessary, since the record level of the internal Tyros2 sounds is fixed. However, when you record other sources, you'll need to use these meters to get the optimum recording level. This also serves as a fail-proof indication that you have sufficient audio level for recording.

IMPORTANT

- Before you begin, make sure you have a hard disk drive properly installed. (See page 221 for instructions on installing a hard disk drive.) Also, make sure there is enough available space on the disk for recording. Your hard disk drive should have at least 100 MB when the drive is first recognized by this instrument. For recording, your hard disk drive should have at least 50 MB.

NOTE

- As a rule of thumb, 1 minute of stereo recording with the Hard Disk Recorder (at 44.1 kHz, 16 bit) will take up roughly 10 MB of hard disk space.

- ▶ **4** Press the **HARD DISK RECORDER [REC]** and **[STOP]** buttons simultaneously.

This creates an audio file for recording.

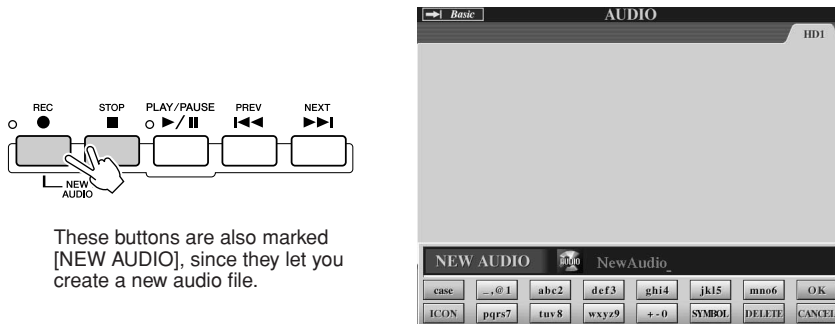

These buttons are also marked [NEW AUDIO], since they let you create a new audio file.

- ▶ **5** Enter a name for the new file.
For instructions on naming, see page 76.
- ▶ **6** Press the **[OK]** LCD button (upper [8] button).



- ▶ **7** Press the **[REC]** button to enable recording.

To cancel recording, press the [REC] button again.

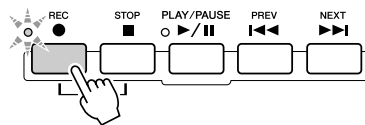

- ▶ **8** Now you're ready to record. Press the **[PLAY/PAUSE]** button to start recording.

Play the keyboard and record your performance.

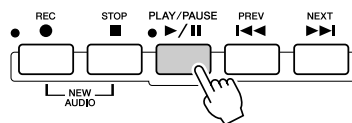

- ▶ **9** When finished recording, press the **[STOP]** button.

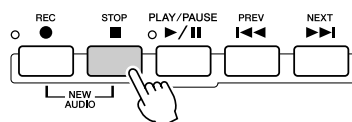

▶ **10** To hear your new recording, press the [PLAY/PAUSE] button.

If you've made a mistake or you're not completely satisfied with your performance, you can use the Undo function to erase the take and try again (starting with Step 7 above). For details, see page 143.

▶ **11** Finally, save the new recording.

Since the recorded data will be erased if another file is selected or the power is turned off, you'll need to save the recording to the hard disk drive.

To do this, press the [SAVE] LCD button ([I] button), then at the prompt, press the [OK] LCD button ([G] button).



NOTE

- You can also re-record in different ways—for example, mix the newly recorded data with the original or replace a certain range of the data (page 141).
- Do not connect or disconnect the USB storage device during audio song playback or recording. Doing so may cause incorrect playback of the song.

CAUTION

- Keep in mind that even if you neglect to save the recorded data in this step, a file with the name specified in Step 5 above will still remain on the hard disk drive. In other words, the file exists on the hard disk drive, but is empty (since it has not been properly saved). If for some reason you name and record a file without saving it, you may want to delete that named (but empty) file to avoid confusion.

To select the previous/next audio song

Press the HARD DISK RECORDER [PREV]/[NEXT] button. This only selects the previous/next song in the same folder level.

NOTE

- The HARD DISK RECORDER [PREV] [NEXT] buttons cannot be used when the VOLUME, REC MODE or START END POINT display is shown.

Recording your singing and playing together

Now that you've learned how to use the Hard Disk Recorder in a simple recording situation, we'll try something a little more complex this time. In this section, you'll play the keyboard with an accompaniment Style, and record your singing at the same time.

▶ 1 Connect a microphone to the Tyros2 and make the necessary settings.

For instructions on connecting and setting up a microphone, see page 47.

▶ 2 Select a style and enable auto accompaniment.

For instructions on selecting a style and using auto accompaniment, see page 31.

▶ 3 Select a voice for the RIGHT 1 part.

For instructions on selecting a voice, see page 25.

▶ 4 Press the HARD DISK RECORDER [REC] and [STOP] buttons simultaneously.

This creates an audio file for recording.

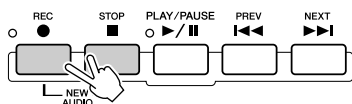

These buttons are also marked [NEW AUDIO], since they let you create a new audio file.



▶ 5 Enter a name for the new file.

For instructions on naming, see page 76.

▶ 6 Press the HARD DISK RECORDER [SETTING] button to call up the Audio Setting display.

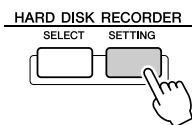

If the Volume page above is not selected, use the [TAB] buttons to call it up.

▶ **7 Practice the part you want to record and check the levels on the REC MONITOR meters.**

Start the style (see page 31), play the keyboard and sing at the same time. Check that the level doesn't constantly go into the "red" and light up the indicator. If it does, you may have to turn the microphone input level down a bit.

Once you're satisfied with the level settings, stop the style.

▶ **8 Press the [REC] button to enable recording.**

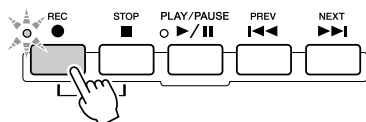

▶ **9 Press the [PLAY/PAUSE] button to start recording.**

Press the [START/STOP] button in the STYLE CONTROL section or use the Sync Start function to start the accompaniment. (See page 31.) Play the keyboard and sing along with your playing.

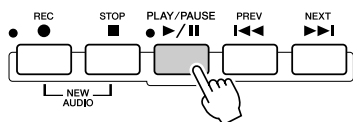

▶ **10 When finished recording, press the [STOP] button.**

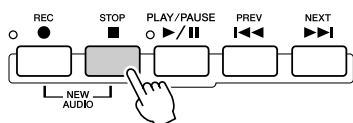

▶ **11 To hear your new recording, press the [PLAY/PAUSE] button.**

▶ **12 Save the new recording.**

Since the recorded data will be erased if another file is selected or the power is turned off, you'll need to save the recording to the hard disk drive.

To do this, press the [SAVE] LCD button ([I] button), then at the prompt, press the [OK] LCD button ([G] button).

To select the previous/next audio song

Press the HARD DISK RECORDER [PREV]/[NEXT] button. This only selects the previous/next song in the same folder level.

CAUTION

- Keep in mind that even if you neglect to save the recorded data in this step, a file with the name specified in Step 5 above will still remain on the hard disk drive. In other words, the file exists on the hard disk drive, but is empty (since it has not been properly saved). If for some reason you name and record a file without saving it, you may want to delete that named (but empty) file to avoid confusion.

NOTE

- The HARD DISK RECORDER [PREV]/[NEXT] buttons cannot be used when the VOLUME, REC MODE or START END POINT display is shown.

Connecting to a USB Storage Device

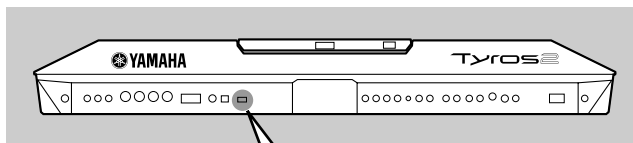
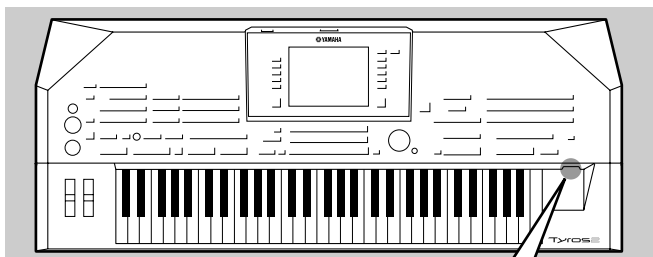

By connecting the instrument to a USB storage device, you can save data you've created to the device, as well as read data from it.

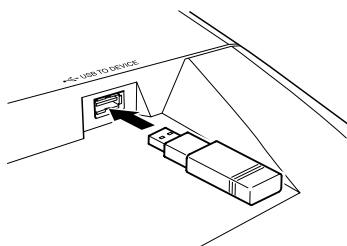

CAUTION

- Avoid frequently turning the power on/off to the USB storage device, or connecting/disconnecting the cable too often. Doing so may result in the operation of the instrument "freezing" or hanging up. While the instrument is accessing data (such as in the Save, Copy and Delete operations and READ/WRITE lamp is on or flashing), do NOT unplug the USB cable, do NOT remove the media from the device, and do NOT turn the power off to either device. Doing so may corrupt the data on either or both devices.

NOTE

- You can also use the [USB TO DEVICE] terminal to connect a USB-type LAN adaptor to access special Internet websites (page 197).

NOTE

- Even with a computer connected to the [USB TO HOST] terminal and a USB storage device connected to the [USB TO DEVICE] terminal, you cannot access the USB storage device from the computer via the instrument.

NOTE

- Though the instrument supports the USB 1.1 standard, you can connect and use a USB 2.0 storage device with the instrument. However, note that the transfer speed is that of USB 1.1.

NOTE

- Do not connect/disconnect/access the USB storage device during Hard Disk Recorder playback. Doing so may result in incorrect song playback using the Hard Disk Recorder.

Compatible USB storage devices

Up to two USB storage devices, such as a floppy disk drive, hard disk drive, CD-ROM drive, flash memory reader/writer, etc., can be connected to the [USB TO DEVICE] terminal. (If necessary, use a USB hub.)

Other USB devices such as a computer keyboard or mouse cannot be used. The instrument does not necessarily support all commercially available USB storage devices. Yamaha cannot guarantee operation of USB storage devices that you purchase. Before purchasing a USB storage device, please consult your Yamaha dealer, or an authorized Yamaha distributor (see list at end of the Owner's Manual) for advice, or see the following web page:

<http://music.yamaha.com/tyros2>

NOTE

- If you are connecting two or three devices to a USB TO DEVICE terminal at the same time (such as two USB storage devices and a LAN adaptor), use a USB hub device. The USB hub must be self-powered (with its own power source) and the power must be on. Only one USB hub can be used. If an error message appears while using the USB hub, disconnect the hub from the instrument, then turn on the power of the instrument and re-connect the USB hub.

NOTE

- Although CD-R/RW drives can be used to read data to the instrument, they cannot be used for saving data.

Using USB Storage Devices

- ▶ **1** Connect the USB storage device to the [USB TO DEVICE] terminal.
- ▶ **2** After connecting, exit once from the selection display, then return to the display (or press the [TAB] buttons simultaneously from the selection display).

This operation refreshes the display to indicated USB storage access. The USB tabs (USB 1, USB 2, etc.) are automatically called up, allowing you to save files and play back music data from the devices.

NOTE

- The tabs indicating the connected USB devices (USB 1, USB 2, etc.) may be displayed up to USB 17 for each device or partition. The numbers are not fixed and may change according to the order in which the devices are connected and disconnected.

Checking remaining memory on the USB storage device

You can check this in the display called up by the following operation:
[FUNCTION] → [I] UTILITY → [TAB] MEDIA

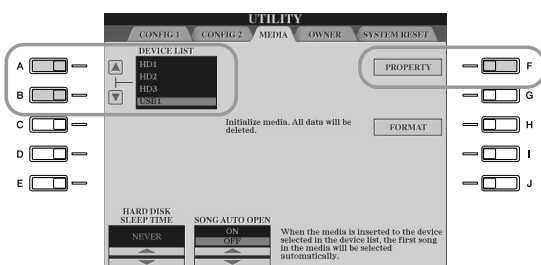

Select the device by using the [A]/[B] buttons in this display and press the [PROPERTY] LCD button ([F] button).

■ Protecting your data (write-protect)

To prevent important data from being inadvertently erased, apply the write-protect provided with each storage device or media. If you are saving data to the USB storage device, make sure to disable write-protect.

■ Formatting USB storage media

When a message appears prompting you to format the device/media, execute the Format operation (page 194).

CAUTION

- The format operation overwrites any previously existing data. Proceed with caution.

Connecting to a Computer

By connecting a computer, you can transfer data between the Tyros2 and the computer via MIDI, and use the computer to control, edit and organize data on the Tyros2. For example, you can use the included Voice Editor program to edit the Tyros2's custom voices. There is also software on our website that lets you use your computer to manage files in the USER/USB/HD (optional) drive.

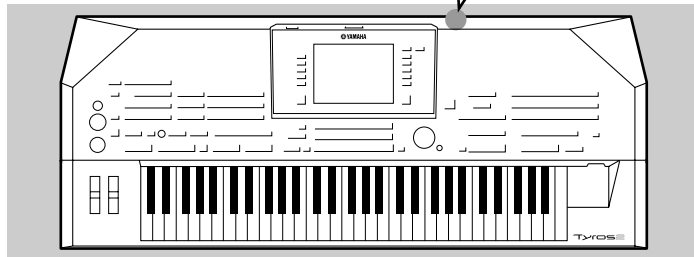
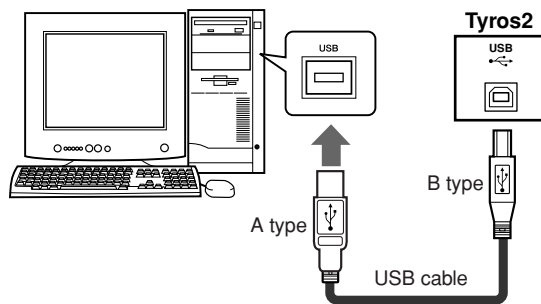

NOTE

- There are two ways to connect the Tyros2 to a computer: MIDI cable and USB cable. In the following instructions, we'll use a USB cable.

■ What you can do with a computer

- Manage files in the Tyros2 using software which is available for free download on the Tyros2 website.
- Create Custom Voices using the Voice Editor software on the included CD-ROM.
- Record performance data (1-16 channels) using the Tyros2 style playback to a computer running sequence software, such as XGworks. After recording, you can edit the data with the computer, then play it back using the Tyros2's tone generator.

CAUTION

Precautions when using the [USB TO HOST] terminal

When connecting the computer to the [USB TO HOST] terminal, make sure to observe the following points. Failing to do so risks freezing the computer and corrupting or losing data. If the computer or the instrument freezes, turn the power to the instrument off and restart the computer.

- Before connecting the computer to the [USB TO HOST] terminal, exit from any power-saving mode of the computer (such as suspended, sleep, standby), quit any open application software, and turn off the power to the instrument.
- Execute the following before turning the power to the instrument off or unplugging the USB cable to/from the instrument/computer.
 - Quit any open application software on the computer.
 - Make sure that data is not being transmitted from the instrument. (Data is transmitted only by playing notes on the keyboard or playing back a song.)
- **While a USB device is connected to the instrument, you should wait for six seconds or more between these operations: When turning the power of the instrument off then on again, or when alternately connecting/disconnecting the USB cable.**

Initial Setup

Instructions are given below in basic outline format. For details, refer to the separate Installation Guide.

- ▶ **1 Confirm the minimum system requirements of the software you wish to use.**
 - For software on the included CD-ROM, refer to the separate Installation Guide.
 - For other software, refer to the relevant manual or documentation.
- ▶ **2 Connect the computer to the Tyros2 using a USB cable.**
- ▶ **3 Start the computer and install the USB MIDI driver.**
 - Refer to the separate Installation Guide.
- ▶ **4 Install the desired software to a computer.**
 - To install Voice Editor from the included CD-ROM, refer to the separate Installation Guide. For details on the Voice Editor, see page 111.
 - To install other software, refer to the relevant manual or documentation.

Accessing a hard disk drive via the USB Storage Mode

When the USB Storage mode is selected, Wave files and song files can be transferred between the internal hard disk drive of the Tyros2 and the computer. In the “normal” mode the USB connection can be used for MIDI control. The USB interface does not directly handle audio signals.

- ▶ **1 Confirm that the hard disk drive is installed to the Tyros2 and turn the computer’s power on.**
- ▶ **2 Turn the Tyros2’s power on while holding the [MUSIC FINDER] button.**
- ▶ **3 Manage files/folders in the hard disk drive installed to the Tyros2 by using the computer.**
- ▶ **4 Press the [EXIT] button to exit the USB storage mode and call up the Main display.**

NOTE

- Windows versions prior to Windows98 SE are not compatible with this USB storage mode.

NOTE

Execute the following before turning the USB Storage mode on/ off.

- Close all application programs.
- If the USB Storage mode is off, make sure that data is not being transmitted from the Tyros2.
- If the USB Storage mode is engaged, make sure that no file reading or writing operation is in progress.
- If the USB Storage mode is engaged, safely remove the Tyros2 from the Windows taskbar or drag the Tyros2 icons from the Macintosh desktop to the trash after closing all Tyros2 windows.

NOTE

- You cannot operate the Tyros2 from the panel while the USB storage mode is engaged. Also, the Tyros2 cannot receive MIDI signals or execute some functions from the pedals while the mode is engaged.

NOTE

- Do not format the hard disk drive from a computer when accessing the drive via the USB storage mode. If you format the hard disk drive while accessing the USB storage mode, the drive may not be able to be used in the Hard Disk Recorder.

CAUTION

- Do not access the HDR ROOT folder containing the audio files that you have created with the Hard Disk Recorder function. If you access the folder or make changes to it (moving the folder or copying some files in the folder, etc.), your important data will be deleted or damaged.

Basic Operations—Organizing Your Data

Display-based Controls

As you've seen in "Quick Guide" above, the Tyros2 features an exceptionally large and easy-to-understand display. It provides comprehensive at-a-glance information on all current settings, and gives you convenient, intuitive control over the Tyros2's functions.

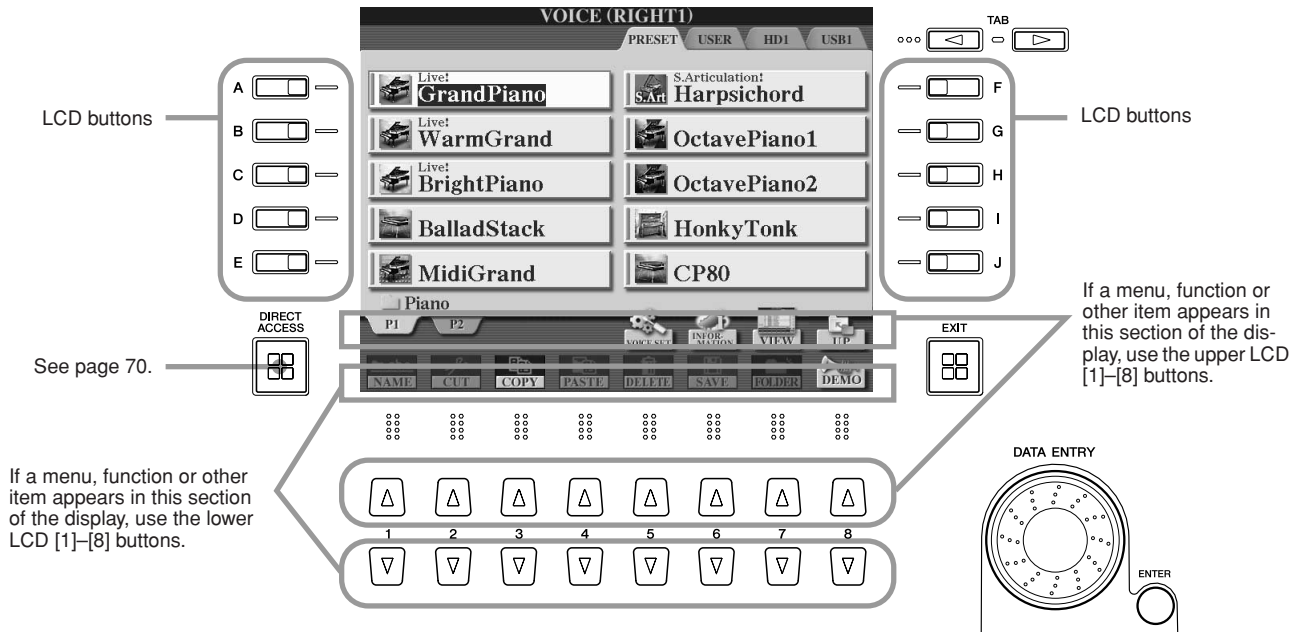

■ LCD (Liquid Crystal Display) buttons.....

The LCD [A]–[J] buttons are used to select the corresponding menu. In the Open/Save display (page 72) shown above, for example, the LCD [A]–[J] buttons can be used to select the corresponding respective voices.

The LCD [1]–[8] buttons are divided into eight sets of upper/lower buttons, and are used to make selections or adjust settings (up or down correspondingly) for functions shown directly above them. In the Open/Save display (page 72) shown above, for example, the upper LCD [1]–[8] buttons can be used to select the menus [P1]–[UP] in the upper row, and the lower LCD [1]–[8] buttons can be used to select the menus [NAME]–[DEMO] in the lower row.

■ [DATA ENTRY] dial and [ENTER] button

Depending on the selected LCD display, the [DATA ENTRY] dial can be used in the following two ways.

● Entering the values

For parameters indicated at the bottom of the Main display (such as the "slider" controls in the mixer window; page 36), you can conveniently use the [DATA ENTRY] dial in tandem with the LCD [1]–[8] buttons. Simply select the desired parameter with the appropriate LCD button (the name changes color), then use the [DATA ENTRY] dial to adjust it. This convenient technique also works well with pop-up parameters such as Tempo and Transpose. Simply press the appropriate button (ex., [TEMPO +]), then rotate the [DATA ENTRY] dial and press [ENTER] to close the window.

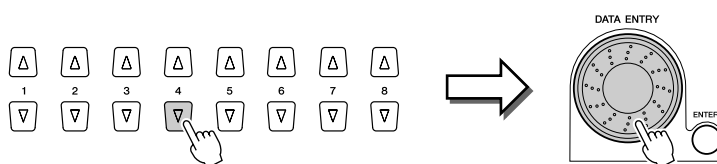

● **Selecting files (voice, style, song, and so on)**

When one of the Open/Save displays (page 72) is shown, you can use the [DATA ENTRY] dial and the [ENTER] button to select a file (voice, style, song, and so on). Rotate the [DATA ENTRY] dial to move the highlight and press the [ENTER] button to actually call up the highlighted file. In the Open/Save display for voices shown above, for example, rotate the [DATA ENTRY] dial to move the cursor to the desired voice and press the [ENTER] button to actually call up the selected voice.

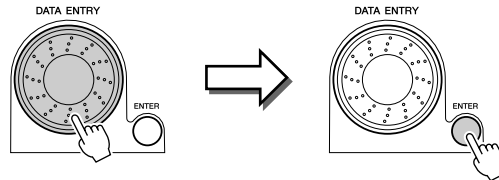

■ **[TAB] button**.....

These buttons are used mainly to change the pages of displays that have “tabs” at the top, such as the Open/Save display (page 72).

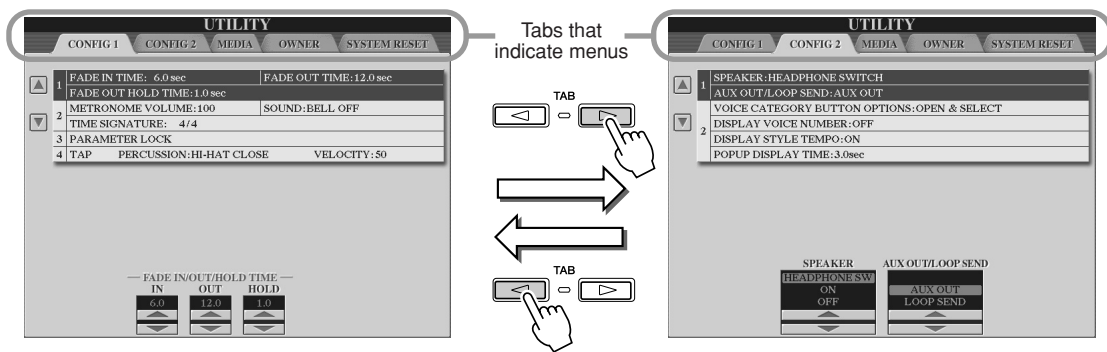

■ **[EXIT] button**.....

No matter where you are in the Tyros2 display hierarchy, the [EXIT] button will return you to the next highest level or to the previously indicated display. Since the Tyros2 has so many different displays, you may occasionally find yourself confused as to which operation’s display is currently shown. If this happens, you can return to “home base” by pressing the [EXIT] button several times. This returns the Tyros2 to the default Main display (page 22)—the same display that appears when the power is turned on.



Display Messages

Thanks to the large LCD panel, the Tyros2 can display comprehensive messages and prompts that clearly guide you through the various operations. When such messages appear, simply follow the instructions as shown by pressing the corresponding LCD button.

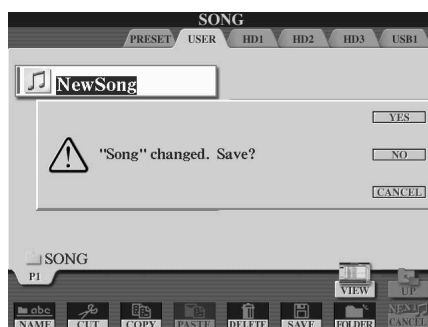

Direct Access—Instant Selection of Displays

With the convenient Direct Access function, you can instantly call up the desired display—with just a single additional button press. Press the [DIRECT ACCESS] button and a message appears in the display prompting you to press the appropriate button. Then, simply press the button corresponding to the desired setting display to instantly call up that display. In the example below, Direct Access is used to call up the display for selecting the Guide settings (page 49).

Refer to the separate Data List for a list of the displays that can be called up with the Direct Access function.

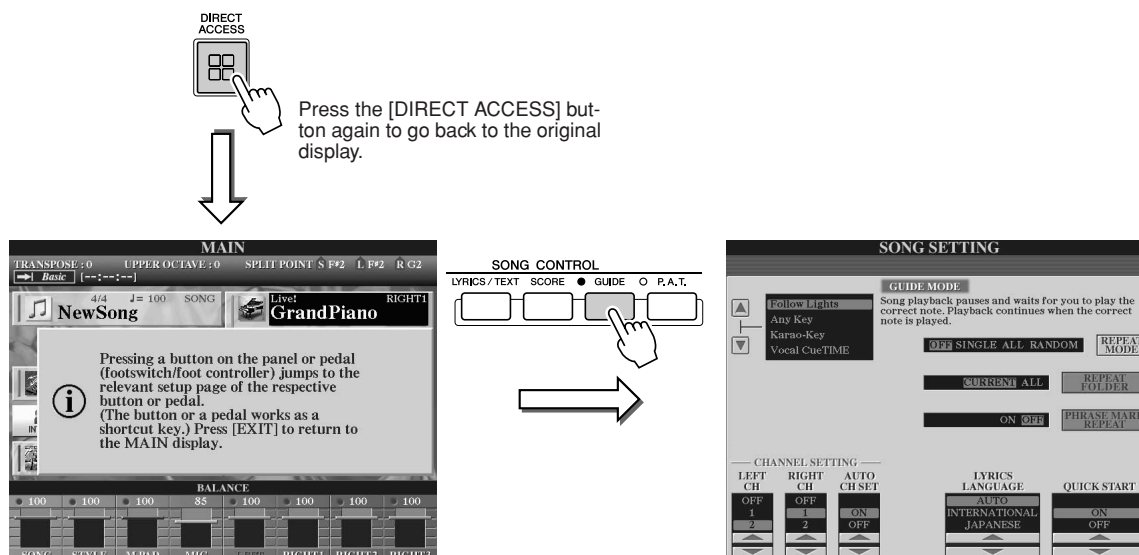

NOTE

- Here's a convenient way to return to the Main display (page 22) from any other display: Simply press the [DIRECT ACCESS] button, then the [EXIT] button.

Basic Structure of File/Folder and Memory Drives

The Tyros2 utilizes a variety of data types—including voices, styles, songs and registration memory settings. Much of this data is already programmed and contained in the Tyros2; you can also create and edit your own data with some of the functions on the instrument. All this data is stored in separate files—just as is done on a computer.

Here, we'll show you the basic structure in handling and organizing the data of the Tyros2 in files and folders using several memory drives.

■ **Data files**.....

The following types of data are handled by the Tyros2 as files. These can be viewed or selected mainly by using the respective Open/Save display.

- **Voices (of musical instruments)**..... pages 25, 84
- **Custom Voices** page 100
- **Library files** page 108
- **Styles** pages 31, 152
- **Songs**..... pages 43, 112
- **Audio data** pages 59, 135
- **Multi Pad Banks** pages 38, 169
- **Registration Memory Banks** pages 52, 173
- **User Effects**
 - Vocal Harmony types* pages 48, 175
 - User Effects* page 183
 - User Master EQ* page 184
 - User Master Compressor* page 185
- **MIDI Setup**
 - MIDI template page 213
- **System Setup**..... page 196
- **Music Finder****..... pages 40, 171, 196
- **Main Picture (displayed on the background of the Main display)**..... page 195
- **Text**..... page 115
- **Lyrics/Text Background Picture** page 114

 **NOTE**

• The Main Picture and the Lyrics/Text Background Picture cannot be created from the Tyros2.

*These data types cannot be saved to the external devices individually.

**The Music Finder feature handles all the Records including the preset and additionally created records as a single file.

■ **File groups and folders**.....

The file types described above are organized into “folders” and stored as such. In the case of voices, the same type of instrument sounds are stored together as files in their own folders—such as Piano, Strings, and Trumpet. The similarly organized buttons on the panel can be considered folders as well, for the various voices and styles.

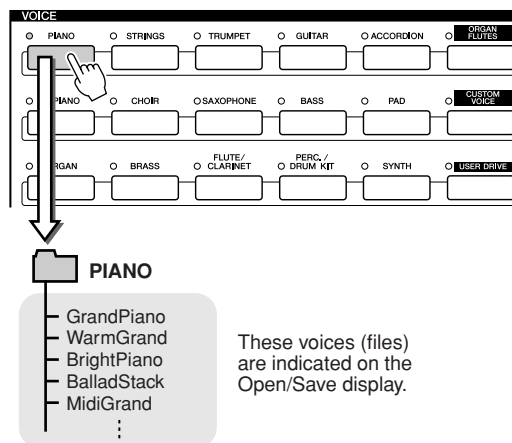

■ **Memory Drives to which folders/files are saved**.....

Folders and files described above are saved to the following memory drives.

- **PRESET drive**..... The files that are pre-programmed and installed internally to the Tyros2 are kept here. Preset files can be loaded (called up) but cannot be re-written to the drive, because it uses ROM (Read Only Memory).
- **USER drive**..... Files kept here are those containing your own original data, created or edited using the various functions of the Tyros2. Since this internal drive uses Flash ROM, the contents are maintained even when the power is turned off.
- **HD drive (optional)**..... An optional hard disk drive can be installed to the Tyros2. Created data can be saved here and recalled.
- **USB drive (optional)**.... Optional USB storage devices can be connected to the Tyros2. Created data can be saved here and recalled.

Folder/File Operations using the Open/Save Display

The Open/Save display is the “home base” for folder/file operations. It is from this display that you save and manage your data files (as described on page 71). Since there are eleven different data types, the Tyros2 has eleven different Open/Save displays. The voice selection, style selection, and song selection displays described in the Quick Guide are all Open/Save displays. This section explains the Open/Save display and the basic operations in the display that are essential for using the Tyros2. The illustration below shows how the Open/Save display for each data type (page 71) is called up and shows the function menus in the display.

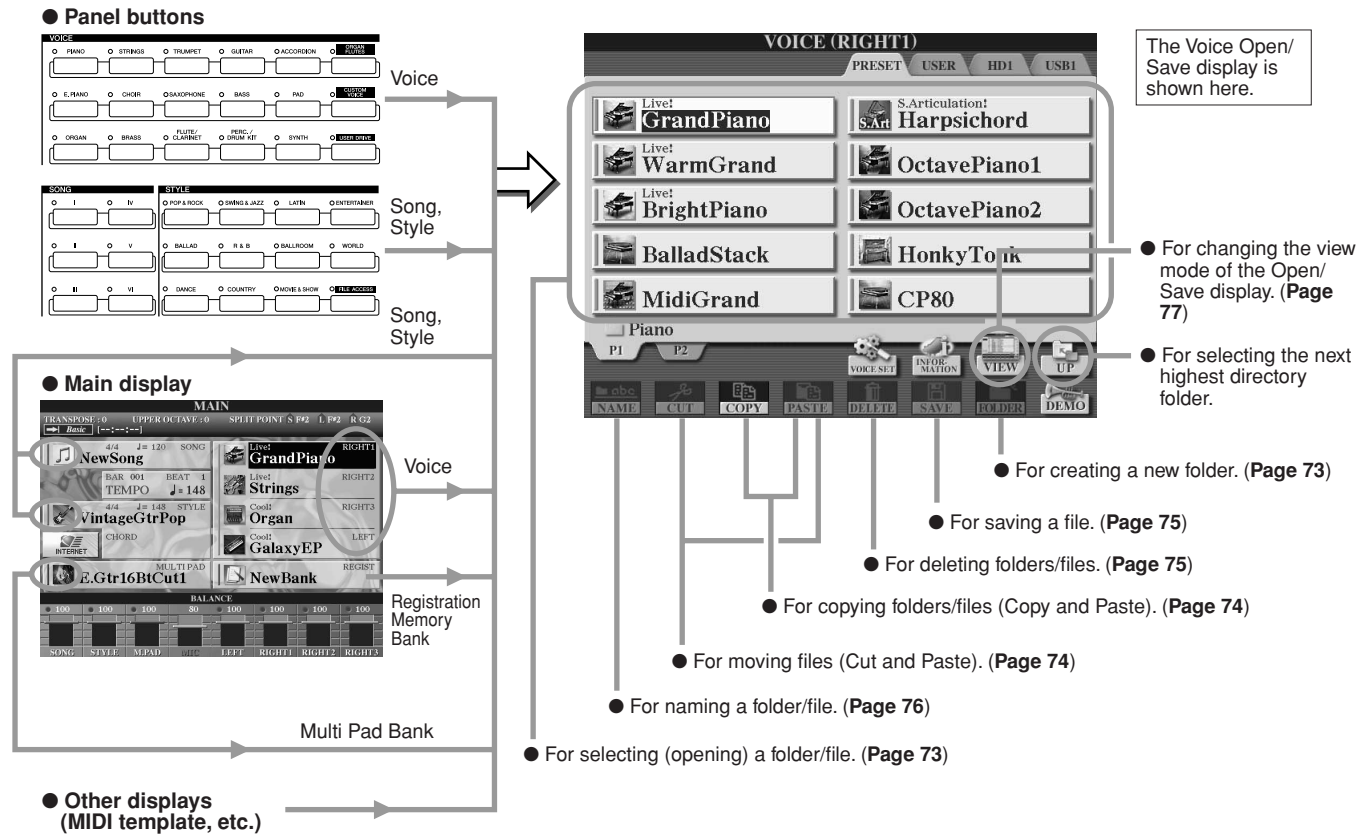

As described on page 71, you can read data from the Preset drive but you cannot write/save to it. As a result, some of the functions above are not available for folders and files on the Preset drive. For details, see below.

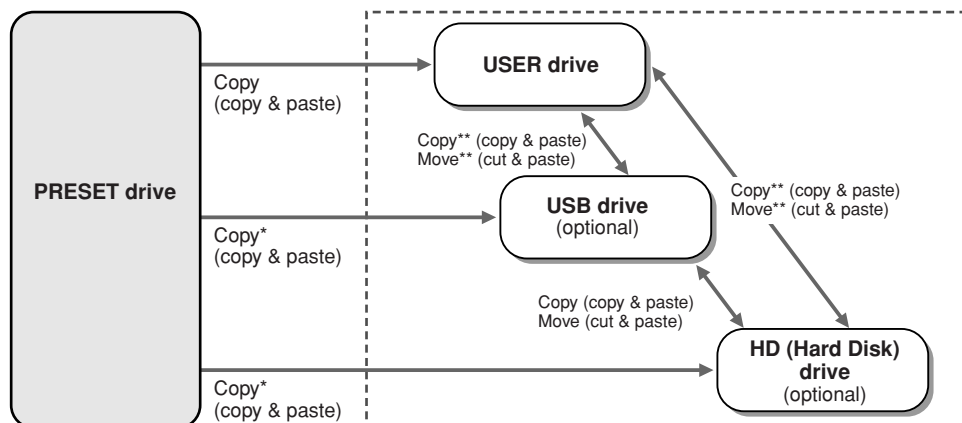

* Some files cannot be copied from the Preset drive because of copyright restrictions.
 **Files which have been copied from the Preset drive cannot be copied or moved to the USB drive or HD drive because of copyright restrictions.

Data can be written to these drives—allowing you to use all the file/folder operations above, including changing file names, deleting files, and creating new folders.

Creating a New Folder

As your Tyros2 data library grows, you'll want to organize it in various folders. This operation lets you create new folders on the User, optional USB storage devices and optional Hard Disk drives. The basic procedure is described below; for a specific example (using Voices), see page 29 in the Quick Guide.

- ▶ **1** Call up the page (path) of the Open/Save display for which you wish to create a new folder.
- ▶ **2** Press the [FOLDER] LCD button (lower [7] button) below the LCD display to call up the pop-up window for entering the folder name.



- ▶ **3** Enter the name of the new folder. See page 76 for instructions on entering names.
- ▶ **4** Press the [OK] LCD button (upper [7] button) to actually create the new folder.

NOTE

- On the User drive, folder directories can contain up to four levels. The maximum total number of files and folders which can be stored is 2,960, but this may differ depending on the length of the file names.
- On the User/USB/HD, the maximum number of files and folders which can be stored in a folder will be 500.

Selecting (Opening) a Folder/File

You can select a folder/file in two ways—by using the LCD letter buttons or by using the [DATA ENTRY] dial.

How to select a file using the LCD buttons

- ▶ **1** Select a memory drive.

- ▶ **2** If there are more folders/files in the drive than can be displayed on a single page (the maximum is ten), use these buttons to select the additional pages.
- ▶ **3** Press the letter button corresponding to the desired folder/file.

NOTE

- Double-clicking the appropriate [A] -[J] button calls up the corresponding file and closes the Open/Save display.

How to select a file using the dial

- ▶ **1** Select a memory drive.

- ▶ **2** Turn the dial to select the desired file/folder. (The selected item is highlighted.)
- ▶ **3** Press the [ENTER] button to call up the selected file.

NOTE

- Double-clicking the [ENTER] button calls up the corresponding file and closes the Open/Save display.

Copying Folders/Files (Copy & Paste)

Folders and files can be freely copied among the installed drives, with the exception of the Preset drive—data can be copied **from** the Preset drive, but not **to** it. The basic procedure is described below; for a specific example (using Voices), see page 29 in the Quick Guide.

- ▶ **1** Call up the page (path) of the Open/Save display, where the relevant folders/files are located.
- ▶ **2** Press the [COPY] LCD button (lower [3] button) at the bottom the LCD display.

The pop-up window for the copy operation appears at the bottom of the LCD display. To return to the original display, press the [CANCEL] LCD button.

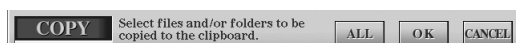

- ▶ **3** Select the desired folders/files to be copied.
Press the LCD letter button that corresponds to the desired folder/file. Several files/folders can be selected together, even those from other pages. Press the [ALL] LCD button (lower [6] button) to select all the folders/files indicated on the current display including the other pages. When the [ALL] LCD button (lower [6] button) is pressed, [ALL] changes to [ALL OFF] letting you release or cancel the selection.
- ▶ **4** Press the [OK] LCD button (lower [7] button) to return to the Open/Save display.
- ▶ **5** Call up the destination display.
The Preset drive cannot be selected as the destination. Create a new folder (page 73) at the destination page (path) as needed.
- ▶ **6** Press the [PASTE] LCD button (lower [4] button).
The folders/files copied from the source page (path) appear on the display.

Moving Files (Cut & Paste)

Files can be freely moved among the installed drives, with the exception of the Preset drive—data can be copied and moved **from** the Preset drive, but not **to** it.

- ▶ **1** Call up the page (path) of the Open/Save display, where the relevant files are located.
- ▶ **2** Press the [CUT] LCD button (lower [2] button) at the bottom the LCD display.
The pop-up window for the Cut operation appears at the bottom of the display. To return to the original display, press the [CANCEL] LCD button.

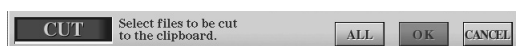

- ▶ **3** Select the desired files to be moved.
The operation is the same as in step #3 of “Copying Folders/Files (Copy & Paste).” See above.
- ▶ **4** Press the [OK] LCD button (lower [7] button) to return back to the Open/Save display.
- ▶ **5** Call up the destination display.
The Preset drive cannot be selected as the destination. Create a new folder (page 73) at the destination page (path) as needed.
- ▶ **6** Press the [PASTE] LCD button (lower [4] button).
The files moved from the source page (path) appear on the display.

Deleting Folders/Files

Folders and files can be freely deleted from the installed drives, with the exception of the Preset drive.

- ▶ **1** Call up the page (path) of the Open/Save display, where the relevant folders/files are located.
- ▶ **2** Press the [DELETE] LCD button (lower [5] button) at the bottom the LCD display. The pop-up window for the Delete operation appears at the bottom of the display. To return to the original display, press the [CANCEL] LCD button.



- ▶ **3** Select the desired folders/files to be deleted. The operation is the same as in step #3 of “Copying Folders/Files (Copy & Paste).” See page 74.
- ▶ **4** Press the [OK] LCD button (lower [7] button). A confirmation prompt appears.
- ▶ **5** Follow the on-screen instructions.

Saving Files

This operation lets you save your original custom data (such as songs and voices you’ve created) to the User, optional USB storage devices or optional Hard Disk drives.

Note that if you’re saving the currently open file, step #1 is not necessary.

- ▶ **1** After you’ve created a song or voice in the relevant display, press the [SAVE] LCD button. The corresponding Open/Save display appears.

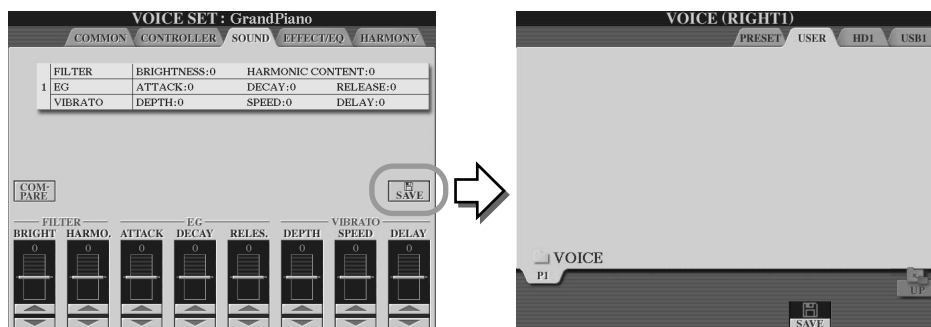

NOTE

- For some editing operations—such as User Effect, User Master EQ, and User Master Compressor—a pop-up window (like that in step #3 here) will be called up instead of the Open/Save display. In this case, steps #2 and #3 are unnecessary.

- ▶ **2** Call up the destination display.
- ▶ **3** Press the [SAVE] LCD button (lower [6] button). The pop-up window for the Save operation appears at the bottom of the display. To return to the original display, press the [CANCEL] LCD button.



- ▶ **4** Enter the file name (page 76).
- ▶ **5** Press the [OK] LCD button (lower [7] button).
- ▶ **6** Press the [OK] button again to actually save the file.

Naming Folders/Files

Folders and files on the installed drives can be freely renamed. You can also name files you've created. The instructions below apply when calling up the Name operation from the Open/Save display. For other cases, go directly to step #5 below.

- ▶ **1** Call up the page (path) of the Open/Save display, where the relevant folders/files are located.
- ▶ **2** Press the [NAME] LCD button (lower [1] button) at the bottom the LCD display. The pop-up window for the Name operation appears at the bottom of the display. To return to the original display, press the [CANCEL] LCD button.



- ▶ **3** Select the desired folder or file to be named.
- ▶ **4** Press the [OK] LCD button (lower [7] button). The pop-up window for entering the name appears at the bottom of the display. To return to the original display, press the [CANCEL] LCD button.
- ▶ **5** Input the name of the selected folder or file.

DATA ENTRY
Move the cursor to the desired position by using the [DATA ENTRY] dial.

Press the appropriate button, corresponding to the character you wish to enter. Several different characters are assigned to each button, and the characters change each time you press the button. To actually enter the selected character, move the cursor or press another letter-input button. Alternately, you can wait for a short time and the characters will be entered automatically.

Call up the ICON SELECT display by pressing the lower [1] button. This lets you change the icon at the left of the file name.

Change the type of character by using the upper [1] button.

- CASE capital letters, numbers, marks
- case lowercase letters, numbers, marks

Deletes the character at the cursor.

Call up the mark (symbol) list by pressing the lower [6] button.

Press the [OK] LCD button (upper [8] button) to actually enter the new name and return to the original display.

Select the desired upper row menu by using the upper LCD [1]–[8] buttons.

Select the desired lower row menu by using the lower LCD [1]–[8] buttons.

Press the [CANCEL] LCD button (lower [8] button) to delete all of the characters on the line at once and return to the original display.

NOTE

- The maximum number of characters that can be used in naming is 41.
- To enter numbers without pressing the button repeatedly, press and hold down the appropriate button for a while.

- ▶ **6** Press the [OK] LCD button (upper [8] button) to actually enter the new name for the item and return to the original display.

Changing the Open/Save Display View

The Open/Save display actually has two different view types. One is Direct Selection, which we've seen up until this point. The other is Number Input, which lets you open files according to their numbers. Switch between the two types by pressing the upper [7] LCD button.

Open/Save display—Direct Selection

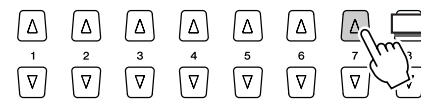

Open/Save display—Number Input

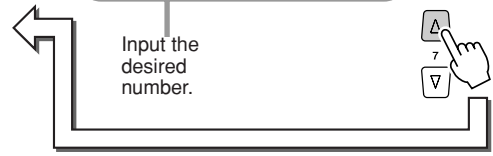
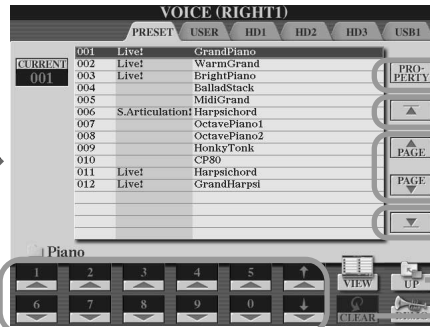

- Shows the property of the drive/folder/file.
- Moves the cursor to the top of this page (path).
- Scrolls up/down through the file list on this page (path).
- Moves the cursor to the end of this page (path).
- Calls up the upper level directory page.
- Press this to cancel the number you've input and return to the original display.

From the Direct Selection type, you select the desired file directly by pressing the appropriate LCD letter button. The Number Input type, on the other hand, lets you call up the desired file by entering the appropriate file number (see below). Since the Tyros2 has many files spread out over several pages, Number Input may be quicker and more convenient—providing you know the number of the file.

Number Input type—Entering numbers.....

To select voice number 128, for example, press the [1], [2] and [8] buttons in sequence as shown below, and press the [ENTER] button. Entering one- or two-digit numbers is done in the same way.

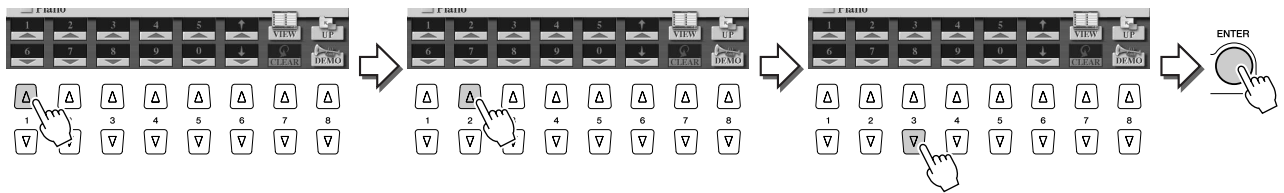

When you select the next or previous file, press the [1]–[6] buttons.



■ **Number Input type—Memorizing paths.....**

The location of the folders and files currently indicated on the LCD display is referred to as a “path.” The Open/Save display for songs and styles lets you memorize the current path to one of the panel buttons. Even if your data is scattered across the drive in a complex hierarchy of folders and paths, you can instantly call up a specific file—no matter how deeply hidden—with a single button-press.

In the example instructions below, the Open/Save display for songs is used.

- ▶ **1** First, select the Number Input type, then call up the path to be memorized to the button and press the [MEMORY] LCD button ([E] button).

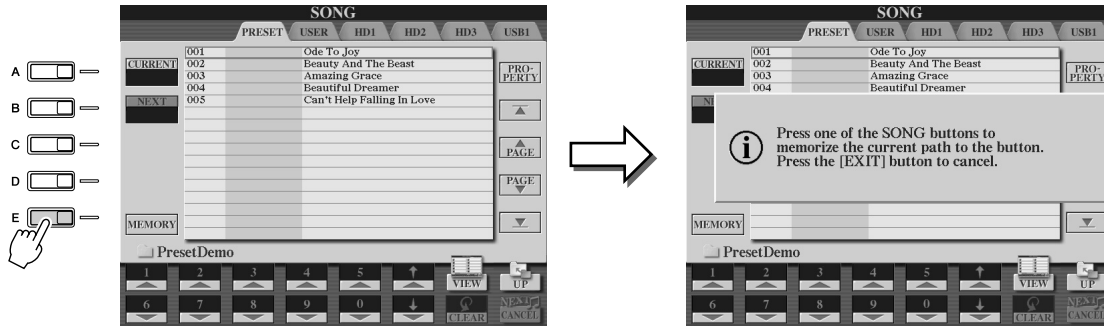

- ▶ **2** Press the desired button in the SONG section (for songs) to which the path (selected in step #1 above) is to be memorized.

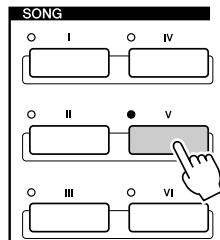

- ▶ **3** Call up the other path (for example, the Open/Save display for voices) and press the same button as in step #2.

You will see the display same as shown in step #1.

Paths for style files can also be memorized, as explained above. See page 156 for details.

About the Highlight Cursor in the Display

As we've seen up to this point, the LCD display lets you select various types of files such as voice, style, song, and lets you adjust the parameter value of various functions. The highlight cursor is another convenient, colorful feature of the LCD display, since it clearly indicates (by a red border and highlighted background) the file to be selected or the parameter to be adjusted.

■ Cursor indication of files (voices, styles, songs, etc.)

The currently selected voice which will sound when you play the keyboard.

You can move the cursor around the Open/Save display by using the [DATA ENTRY] dial. The highlighted item is not actually selected until you press the [ENTER] button.

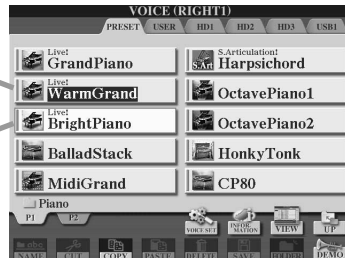

■ Cursor indication of parameters



In this display (Mixing Console), the selected parameter for editing is highlighted; use the [DATA ENTRY] dial to adjust the parameter.

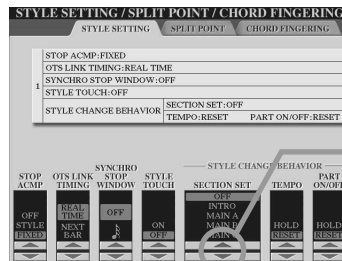

In this display (Style Setting), the selected arrow indicators are highlighted in red. Use the [DATA ENTRY] dial to adjust the selected parameter.

About the Panel Button Colors

The panel buttons listed in the chart below light in one of two colors: green or red. This easy-to-understand color-coding scheme indicates the status of the button/function, as described here.

- **Off** No data is currently assigned to the button.
- **Green** Data has been assigned to the button.
- **Red** Data has been assigned to the button and the button is active or playing back.

For details about each button, see below.

	Off	Green	Red
[REGISTRATION MEMORY] buttons	No panel settings are memorized to the button.	Panel settings are memorized to the button.	Panel settings are memorized to the button and the button is active (was selected last).
[PROGRAMMABLE ONE TOUCH SETTING] buttons	No panel settings are memorized to the button.	Panel settings are memorized to the button.	Panel settings are memorized to the button and the button is active (was selected last).
INTRO [I]–[III] buttons MAIN VARIATION [A]–[D] buttons [BREAK] button ENDING/rit.[I]–[III] buttons	The corresponding section of the selected style has no data.	The corresponding section of the selected style has data.	The corresponding section of the selected style has data and is active.
[SP1]–[SP4] buttons	No song position marker is assigned to the button.	A song position marker is assigned to the button.	A song position marker is assigned to the button and represents the latest marker to be passed during playback.
MULTI PAD [1]–[4] buttons	No data is assigned to the Multi Pad.	Data is assigned to the Multi Pad.	Active (playing back).

About the Keyboard

The Tyros2 keyboard features various functions and performance conveniences that are simply unavailable on an acoustic instrument. As explained in the Quick Guide for example, it allows you to play several different voices together in a layer, or play one voice with your left hand while you play a different voice (or even three layered voices!) with your right. Below is a summary of the keyboard-related functions and modes.

Keyboard Sections and Their Functions

● Playing a single voice

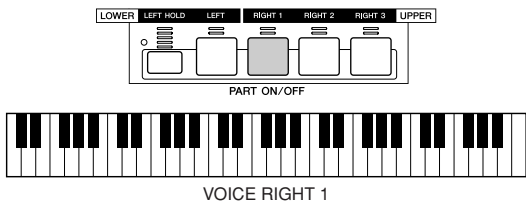

● Playing three voices in a layer

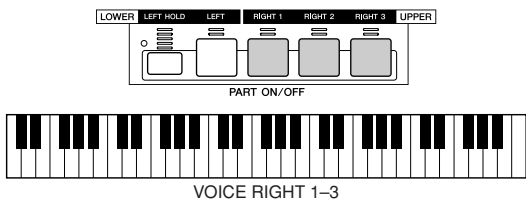

● When [ACMP] (style playback) is turned on:

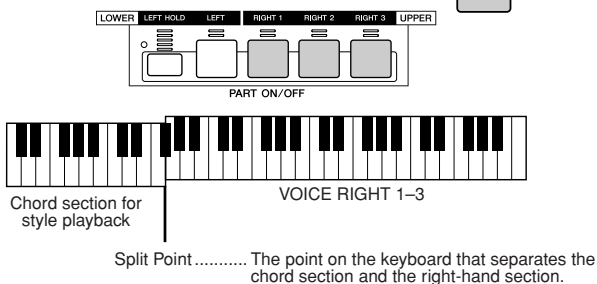

● Playing two voices in a layer

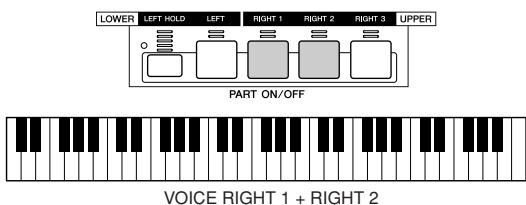

● Playing separate voices with the right and left hands

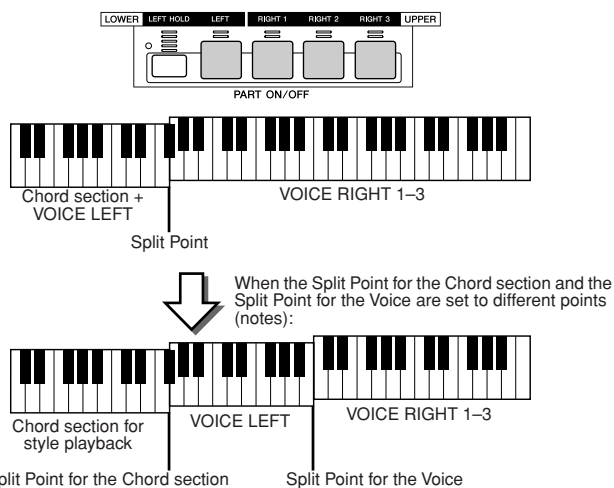
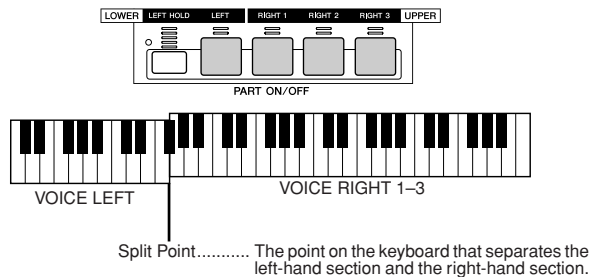

RIGHT 3 Split Point

You can set a separate split point to be specified for the R3 voice. This means that you could, for example, assign only the top octave of the keyboard to a percussion or sound-effect voice.

Synchro Start On/Off

The convenient Synchro Start function lets you start style or song playback by simply playing a key on the keyboard. Naturally, it should be set to on (standby) when you want to use it.

● Synchro Start—Style Playback (page 31)

Turn it on or off by pressing the [SYNC START] button in the STYLE CONTROL section. When Synchro Start is on, style playback behaves in two different ways, depending on the [ACMP] button status:

- When [ACMP] is off—
Only the Rhythm part (channel) of the selected style starts as soon as you play any key on the keyboard.
- When [ACMP] is on—
All parts of the selected style start as soon as you play a key/chord in the Chord section of the keyboard. (Playing in any other section does not start the style.)



● Synchro Start—Song Playback

To turn Synchro Start on or off, simultaneously hold down the [STOP] button and press the [PLAY/PAUSE] button in the SONG CONTROL section. When Synchro Start is on, the song starts from the current position as soon as you play the keyboard.

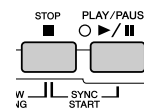

Function Tree

- **Button/Controller**Indicates the Button/Controller that you should use at first for entering the corresponding function. Numbers at the left end correspond to the ones in “Top panel & connections” on page 14.
- **LCD title**This appears at the top of the LCD display called up by operating the Button/Controller. “---” indicates that no LCD display is called up by operating the Button/Controller.
- **Function**Describes the function that can be executed on the LCD display called up by operating the Button/Controller. Describes the function of the Button/Controller itself if the LCD title is “---.”

The numbers to the left of the chart correspond to the those in the “Panel Controls and Terminals” section on page 14.

	Button/Controller	LCD title	Function	Page
①	POWER ON/OFF switch	---	Turning the POWER on or off	20, 22
②	MASTER VOLUME control	---	Adjusting the overall volume	20
③	INPUT VOLUME control	---	Adjusting the microphone sound volume	47, 175
④	DEMO button	DEMO	Demo song selection/playback	24
⑤	MIC/LINE IN buttons			
	[VOCAL HARMONY] button	---	Turning Vocal Harmony on or off	48, 175
	[TALK] button	---	Calling up the Talk Settings related to the microphone sound	177
	[EFFECT] button	---	Turning the effect for the microphone sound on or off	175
	[VH TYPE SELECT] button	VOCAL HARMONY TYPE	Selecting/producing the Vocal Harmony effect	48, 175
		MICROPHONE SETTING		
	[MIC SETTING] button	OVERALL SETTING	Setting microphone related parameters such as EQ, Noise Gate, and Compressor	177
		TALK SETTING	Setting the Talk Setting related parameters	177
⑥	SONG CONTROL buttons			
	[LYRICS/TEXT] button	LYRICS/TEXT	Showing the lyrics of a song or text	114–115
	[SCORE] button	SCORE	Showing the score of a song	112
	[GUIDE] button	---	Turning the Guide function on or off	50
	[P.A.T.] button	---	Turning the Performance Assistant Technology on or off	120
	[SP1]–[SP4] buttons	---	Entering Song Position Markers to the selected song and executing jumps among the Markers.	44, 117
	[LOOP] button	---	Turning looped playback (between Markers) on or off	45, 117
	[REC] button	(Pop-up window)	Recording a song	55
	[STOP] button	---	Stopping playback or recording of the selected song	43
	[PLAY/PAUSE] button	---	Playing/pausing playback or recording of the selected song	43
	[REW] button	(Pop-up window)	Fast reverse of the song playback position	43, 117
	[FF] button	(Pop-up window)	Fast forward of the song playback position	43, 117
⑦	FADE IN/OUT button	---	Producing smooth fade-ins and fade-outs when starting and stopping the style/song	154
⑧	SONG buttons	SONG	The Open/Save display for songs	43, 72
⑨	STYLE buttons		The Open/Save display for styles	31, 72
	[POP & ROCK]–[WORLD] button	STYLE	The Open/Save display of the category (path) that corresponds to the selected button	156
	[FILE ACCESS] button	STYLE	Turning the File Access function on or off	156
⑩	STYLE CONTROL buttons			
	[ACMP] button	---	Turning ACMP (Auto Accompaniment) on or off	31
	[OTS LINK] button	---	Turning the OTS Link function on or off	155
	[AUTO FILL IN] button	---	Turning the Auto Fill in on or off	35
	[INTRO] buttons	---	Playing the Intro sections of the selected style	34
	[MAIN VARIATION] buttons	---	Playing the Main sections of the selected style	34
	[BREAK] button	---	Playing the Break sections of the selected style	34
	[ENDING/rit.] button	---	Playing the Ending sections of the selected style	34
	[SYNC STOP] button	---	Turning Sync Stop on or off	155
	[SYNC START] button	---	Turning Sync Start on or off	31, 155
	[START/STOP] button	---	Starting/stopping style playback	32
⑪	METRONOME button	---	Starting/stopping the Metronome	193
⑫	TAP TEMPO button	---	Tapping out the tempo of the style playback	154
⑬	TEMPO buttons	(Pop-up window)	Changing the tempo of the Style/Multi Pad/Song playback	154
⑭	TRANSCOPE buttons	(Pop-up window)	Transposing the pitch up or down	88

Button/Controller	LCD title	Function	Page
15 MULTI PAD CONTROL buttons			
[SELECT] button	MULTI PAD	Open/Save display for Multi Pads	38, 169
[1]–[4] buttons	---	Playing the Multi Pads	38, 169
[STOP] button	---	Stopping the Multi Pad playback	38, 169
16 BALANCE button	(Pop-up window)	Adjusting the volume balance among parts	36, 46
17 MIXING CONSOLE button	MIXING CONSOLE		
	VOL/VOICE	Adjusting the volume and pan for each part and setting the Song Auto Revoice	180
	FILTER	Adjusting the Harmonic content and Brightness for each part	180
	TUNE	Adjusting the pitch related parameters for each part including the transpose setting	180
	EFFECT	Adjusting the effect depth for each part and setting the Effect type/parameter for each block	181
	EQ	Selecting/producing a Master EQ type and adjusting the EQ gain for each part	184
	CMP	Selecting/producing a Master compressor type	185
	LINE OUT	Line out settings for each part and for each instrument (key) of the drum voice	185
18 CHANNEL ON/OFF button	(Pop-up window)	Turning each channel (part) of the selected song/style playback on or off	37, 46
19 REGISTRATION MEMORY buttons			
REGIST BANK [-] [+] buttons	REGISTRATION BANK	Pressing both [-] [+] buttons simultaneously: Open/save display for Registration Memory Banks Pressing a [-]/[+] button: Pop-up window for selecting previous/subsequent Registration Memory Bank	53
[FREEZE] button	---	Turning the Freeze function on or off	173
[1]–[8] buttons	---	Recalling various panel settings	52
[MEMORY] button	REGISTRATION MEMORY CONTENTS	Memorizing various panel settings to Registration Memory/One Touch Setting	52
20 PROGRAMMABLE MUSIC FINDER button	MUSIC FINDER	Selecting/Editing /Searching a Record of the Music Finder	40, 171
21 FUNCTION button	MASTER TUNE/SCALE TUNE		
	MASTER TUNE	Setting the overall pitch of the Tyros2	187
	SCALE TUNE	Tuning each individual note of the octave	187
	SONG SETTING	Setting the song playback related parameters, such as Guide function settings	118
	STYLE SETTING/SPLIT POINT/CHORD FINGERING		
	STYLE SETTING	Setting the style playback related parameters.	157
	SPLIT POINT	Setting the split points.	158
	CHORD FINGERING	Selecting the way in which chords are played with your left hand	152
	CONTROLLER		
	FOOT PEDAL	Assigning the foot pedal function	189
	KEYBOARD/PANEL	Setting the keyboard related parameters, such as Initial Touch and After-touch	191
	REGIST SEQUENCE/FREEZE/VOICE SET		
	REGISTRATION SEQUENCE	Setting the Registration Memory Sequence	173
	FREEZE	Specifying which settings are affected by the Freeze function	173
	VOICE SET	Determining whether the preset settings are recalled or not when a new voice is selected	188
	HARMONY/ECHO	Selecting a Harmony/Echo type and setting related parameters	39, 191
	SCREEN OUT	Setting the display characteristics that are output to a monitor connected to the [RGB OUT] or [VIDEO OUT] jack.	188
	MIDI	Selecting a MIDI template	213
	SYSTEM	MIDI system-related parameter settings	215
	TRANSMIT	MIDI transmit channel settings	215
	RECEIVE	MIDI receive channel settings	216
	BASS	MIDI chord root settings that determines whether or not the Tyros2 recognizes the received note event as the chord root for the style playback	217
	CHORD DETECT	MIDI chord root settings that determines whether or not the Tyros2 recognizes the received note event as the chord type for the style playback	217
	MFC10	Setting the parameters related to a connected optional MFC10	217
	UTILITY		
	CONFIG 1	Setting various parameters such as the Fade In/Out and the metronome	193
	CONFIG 2	Setting the parameter that determines whether the voice program change number will be indicated on the Open/Save display for voices and the parameter that determines whether the optionally installed speaker will sound or not.	193
	MEDIA	Executing the media related operations such as format	194
	OWNER	Executing operations such as registering your name to the Tyros2	195
	SYSTEM RESET	Resetting the internal Flash ROM to the Factory Set	195

Button/Controller	LCD title	Function	Page
22 VOICE CREATOR button	WAVE IMPORT	Importing WAVE audio files	94
	CUSTOM VOICE BANK EDIT	Organizing Custom Voice Banks	102
	INDIVIDUAL LOAD	Loading (selecting and assigning) Custom Voices	104
	LIBRARY LOAD	Loading Library files	106
	LIBRARY SAVE	Saving Custom Voice Banks as Library files	108
	CUSTOM VOICE EDIT via PC	Editing Custom Voices on PC using included Voice Editor software	111
23 DIGITAL RECORDING button	SONG CREATOR	Creating a User Song	121
	REC MODE	Setting parameters that determine how recording starts and stops, such as Punch In/Out settings	122
	CHANNEL	Editing recorded song data for each part (channel)	123
	CHORD	Recording Chord data for the style playback using the Event List	125
	1-16	Recording MIDI events for each channel using the Event List	127
	SYS/EX.	Recording System Exclusive Messages using the Event List	133
	LYRICS	Recording Lyrics data using the Event List	133
	STYLE CREATOR	Creating a User Style	159
	BASIC	Setting basic parameters such as beat, pattern length, section/part (channel) to be recorded	161
	ASSEMBLY	Assembling an original style by combining existing rhythm patterns from other styles	163
	GROOVE	Altering the timing for each section, velocity of notes for each channel	163
	CHANNEL	Editing recorded style data for each part (channel)	165
	PARAMETER	Editing various parameters related to the Style File Format	165
	EDIT	Recording MIDI events for each channel using the Event List	162
	MULTI PAD CREATOR	Creating a User Multi Pad	169
	RECORD	Turning Repeat and Chord Match on or off, and recording a Multi Pad	169
	EDIT	Recording MIDI events for each pad using the Event List	170
24 HARD DISK RECORDER buttons			
[SELECT] button	AUDIO	Open/Save display for audio songs	59, 135
[SETTING] button	AUDIO SETTING		
	VOLUME	Adjusting the volume of the audio song	142
	REC MODE	Setting the audio song recording related parameters, such as punch in/out recording	141, 143
[REC] button	---	Recording an audio song	59, 135
[STOP] button	---	Stopping playback or recording of the selected song	59, 135
[PLAY/PAUSE] button	---	Playing/pausing playback or recording of the selected song	59, 135
[PREV] button	---	Selecting audio songs or fast reverse of the song playback position	61, 149
[NEXT] button	---	Selecting audio songs or fast forward of the song playback position	61, 149
25 VOICE buttons	VOICE	Open/Save display for voices	25, 72
26 PART SELECT buttons	---	Selecting a keyboard part from among four parts (RIGHT 1, 2, 3, LEFT)	84
27 PART ON/OFF buttons	---	Turning each keyboard part (RIGHT 1, 2, 3, LEFT) on or off	80, 84
28 VOICE EFFECT buttons			
[HARMONY/ECHO] button	---	Turning Harmony/Echo on or off	39, 191
[INITIAL TOUCH] button	---	Turning Initial Touch on or off	39, 87
[SUSTAIN] button	---	Turning Sustain on or off	39, 87
[MONO] button	---	Setting the selected keyboard part to Poly or Mono	39, 87
[DSP] button	---	Setting the DSP effect of the selected keyboard part to on or off	39, 87
[DSP VARIATION] button	---	Setting the DSP effect variations of the selected keyboard part to on or off	39, 87
29 PROGRAMMABLE ONE TOUCH SETTING buttons			
[1]–[4]	---	Calling up various panel settings that match the selected style	36, 155
30 UPPER OCTAVE buttons	---	Transposing Upper parts (RIGHT 1–3) up or down by one octave	27
31 PITCH BEND wheel	---	Bending notes played on the keyboard up or down	88
32 MODULATION wheel	---	Applying a vibrato effect to notes played on the keyboard	88

Voices and Keyboard Parts

As you know by now, the Tyros2 has a wide variety of musical instrument sounds, referred to as “voices.” And, as shown on page 80, the Tyros2 allows you to independently select and play up to four voice parts at the same time in a number of ways. Any voice can be assigned to any part. Since there are four different parts, be careful to confirm which parts are selected, and make sure not to confuse one part for another as you select voices for them.

See below for details on confirming the currently selected part, and instructions on selecting parts.

You can confirm the currently selected part by checking which lamp of the [PART SELECT] buttons lights. To select the desired keyboard part, press the corresponding part button.

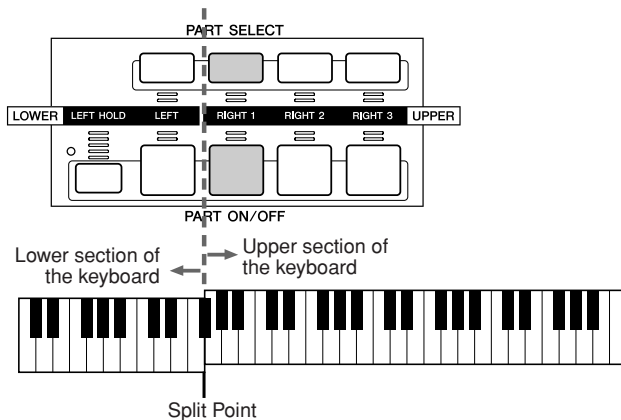

If you want to turn only a specified part on, press one of the [PART ON/OFF] buttons.

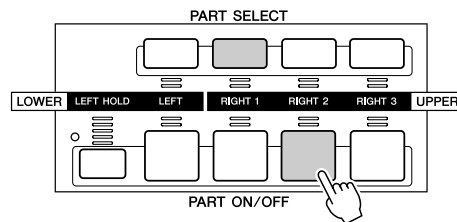

■ Note names of the keyboard

Each key has a note name; for example, the lowest (farthest left) key on the keyboard corresponds to C1 and the highest (farthest right) key to C6.

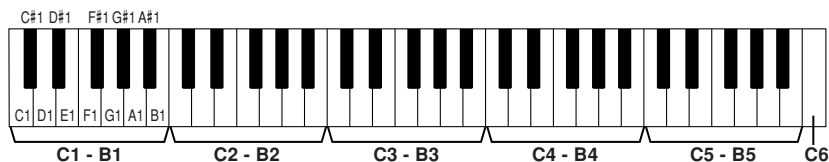

■ Left Hold

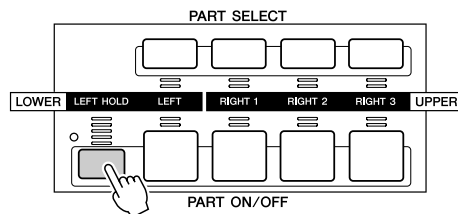

This function causes the LEFT part voice to be held even when the keys are released. Non-decaying voices such as strings are held continuously, while decay-type voices such as piano decay more slowly (as if the sustain pedal has been pressed). This function is especially effective when used with style playback. For example, if you play and release a chord in the Chord section of the keyboard (with the Left part on and the Left voice set to Strings), the strings part sustains, adding a natural richness to the overall accompaniment sound.

Voice Types

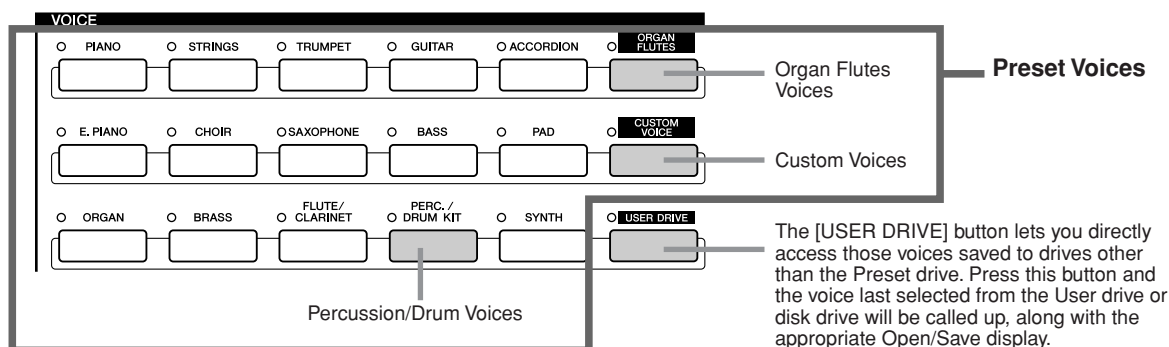

The buttons of the VOICE section (excepting USER DRIVE) are used to call up the relevant voice selection (Open/Save) display for the Preset drive. Pressing one of the buttons calls up the voice selection display corresponding to the selected category, and the last selected voice in the category is automatically called up. Five of these voice categories (below) are slightly different from the others and deserve special explanation.

■ Organ Flutes Voices.....

Press the [ORGAN FLUTES] button to call up the Open/Save display for selecting among the special organ voices. You can also use the Voice Set features (displayed as FOOTAGE) to create your own original organ sounds.

Just as on a traditional organ, you can create your own sounds by adjusting the levels of the flute footages.

■ Percussion/Drum Kit Voices.....

When one of the Drum Kit or SFX Kit voices in the [PERC./DRUM KIT] group is selected, you can play various drums and percussion instruments or SFX (sound effects) sounds on the keyboard. The drum and percussion instruments played by the various keys are marked by symbols below the keys. Some of the instruments in the different drum kit voices sound different even though they have the same name, while others are essentially the same.

See the separate Data List for a complete listing of the Drum Kit and SFX Kit assignments.

When "Standard Kit 1" is selected:

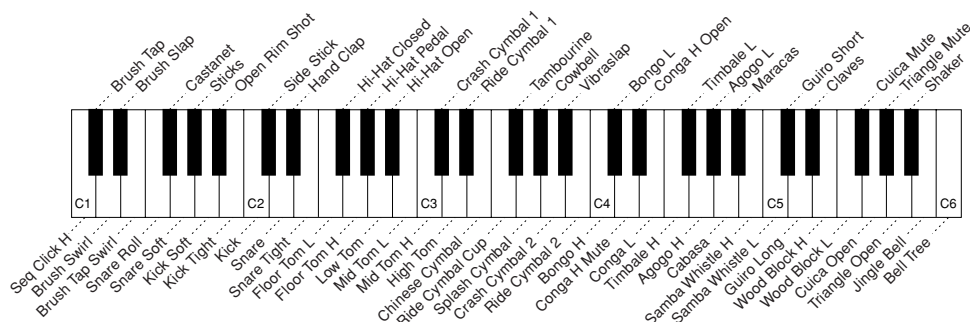

NOTE

- The Transpose functions (page 88) do not affect the Drum Kit or SFX Kit voices.

■ GM&XG Voices and GM2 Voices.....

You can select the GM/XG/GM2 voices (page 212) directly via panel operations. Press one of the VOICE buttons to call up the Open/Save display for voices, then press the [UP] LCD button (upper [8] button) and call up the P2 page containing the "GM&XG" folder and the "GM2" folder.

■ Custom Voices.....

Your original voices created by using the Voice Creator function (page 94) or with the Voice Editor software (pages 66, 111) can be saved to the Preset drive as Custom voice data. Custom Voices saved to the Preset drive can be called up via the [CUSTOM VOICE] button.

■ Voice Characteristics.....

The Voice type and its defining characteristics are indicated above the Preset voice or Custom voice name.

Live!	These acoustic instrument sounds were sampled in stereo, to produce a truly authentic, rich sound—full of atmosphere and ambience.
Cool!	These Voices capture the dynamic textures and subtle nuances of electric instruments—thanks to a huge amount of memory and some very sophisticated programming.
Sweet!	These acoustic instrument sounds also benefit from Yamaha’s sophisticated technology—and feature a sound so finely detailed and natural, you’ll swear you’re playing the real thing!
Drums	Various drum and percussion sounds are assigned to individual keys, letting you play the sounds from the keyboard.
SFX	Various special effect sounds are assigned to individual keys, letting you play the sounds from the keyboard.
Organ Flutes!	This authentic organ Voice lets you use the Voice Set to adjust the various footages and craft your own original organ sounds. See page 97 for details.
MegaVoice	The MegaVoices are not intended to be played from the keyboard but are designed to be used with recorded MIDI data (including songs and styles). MegaVoices make special use of velocity switching, with completely different sounds in the various velocity ranges. For example, a guitar MegaVoice has a huge variety of specific performance techniques assigned to different velocity ranges—making the voice difficult to “play” in real time (because of the precise velocities needed), but very useful when creating realistic tracks with MIDI data, especially when you want to avoid using several different voices just to make a single instrumental part. Sound maps for the Tyros2’s Megavoices are given in the separate Data List booklet.
S. Articulation!	The Super Articulation voices sound remarkably authentic and natural, featuring the unique performance characteristics of each instrument—for example, guitar scratching sounds or the legato phrasing of wind instruments. They provide many of the same benefits as the MegaVoices, but with greater playability and expressive control in real time. To effectively play these natural sounds in performance of certain voices, you may need to use the pitch bend wheel or footswitch. For details on how to best play each voice, call up the Information window (pressing the upper [6] button in the voice’s Open/Save display).
Live!Drums	These are high-quality drum sounds taking full advantage of Stereo Sampling and Dynamic Sampling.
Live!SFX	These are high-quality Latin percussion sounds taking full advantage of Stereo Sampling and Dynamic sampling. They give you a broader and more versatile range of Latin percussion than the normal drum Voices.
Custom!	Custom voices which you have created by using the Custom voice function.
CustomWA!	Custom voices which contain Wave data.

NOTE

Notes for MegaVoices:

Unexpected or undesired sounds may result depending on the settings or conditions below:

- Initial Touch setting in the [FUNCTION] → CONTROLLER → KEYBOARD/PANEL display (page 191)
- Harmony/Echo settings in the [FUNCTION] → HARMONY/ECHO display (page 191)
- Touch sensitivity-related settings in the Voice Set (page 91)
- Playing keys in the left-hand Chord sections when Stop Accompaniment (page 157) is set to “STYLE.”

Unexpected or undesired sounds may result depending on the settings below, when editing or creating data for songs, styles, and Multi Pads:

- When selecting a MegaVoice from the Revoice display of a style (page 37).
- When changing the velocity values of several notes at once in the Event List displays of song, style, or Multi Pad (page 127).
- When changing the velocity values of several notes at once with the Velocity Change function (page 165) and the Dynamics function (page 163) in the Style Creator function.
- When changing the note numbers of several specified channels at once with the Channel Transpose function (page 124) in the Song Creator function.

Notes for Super Articulation voices: Unexpected or undesired sounds may result depending on the setting or conditions below:

- Using Performance Assistant Technology (page 120)
- Mono (page 87)
- Harmony/Echo settings in the [FUNCTION] → HARMONY-ECHO display (page 191)
- Sostenuto setting in the [FUNCTION] → CONTROLLER → FOOTPEDAL → Sostenuto (page 190)
- Pitch to Note parameter in the [VH TYPE SELECT] → Parameter in the Edit display (page 48)
- Re-recorded or edited songs

When changing the note numbers of several specified channels at once with the Channel Transpose function (page 124) in the Song Creator function, unexpected or undesired sounds may result.

On some voices, the playing of trills causes the voice to automatically sound monophonically, even when the voice is normally polyphonic.

MegaVoices and Super Articulation voices are only compatible with other models which have those two types of voices installed. Any song, style or Multi Pads data you’ve created on the Tyros2 using the MegaVoices or Super Articulation voices will not sound properly when played back on instruments that do not have these types of voices.

Maximum Polyphony

The Tyros2 features a maximum polyphony of 128 notes. Since style playback uses a number of the available notes, the full 128 notes will not be available on the keyboard when a style is played back. The same applies to the Voice RIGHT 1, RIGHT 2, RIGHT 3, LEFT, Multi Pad, and Song functions. When the maximum polyphony is exceeded, notes are played using last-note priority.

Voice Effects

Quick Guide on page 39 ➔

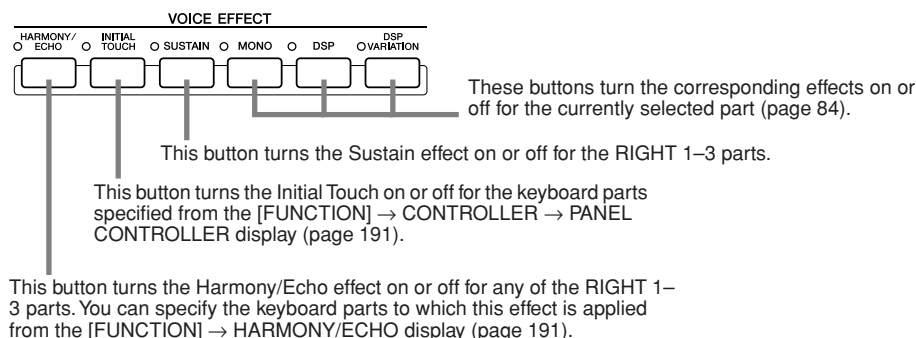

■ Harmony/Echo

See page 39 in “Quick Guide” and page 191 in “Reference.”

■ Initial Touch

The keyboard of the Tyros2 is equipped with a touch response feature that lets you dynamically and expressively control the level of the voices with your playing strength—just as on an acoustic instrument. There are two types of touch response on the Tyros2 keyboard (described below): Initial Touch and Aftertouch. Initial Touch can be turned on or off from the panel.

Two types of touch response equipped with the keyboard of the Tyros2

● Initial Touch

With this function, the Tyros2 senses how strongly or softly you play the keys, and uses that playing strength to affect the sound in various ways, depending on the selected voice. This allows you to play with greater expressiveness and add effects with your playing technique.

You can set the keyboard parts to which Initial Touch is applied from the [FUNCTION] → CONTROLLER → PANEL CONTROLLER display (page 191).

● Aftertouch

With this function, the Tyros2 senses how much pressure you apply to the keys while playing, and uses that pressure to affect the sound in various ways, depending on the selected voice. This also gives you more expressive control over the sound and effects.

You can set the keyboard parts to which Aftertouch is applied from the [FUNCTION] → CONTROLLER → KEYBOARD/PANEL display (page 191).

The default settings for Aftertouch and how it affects a voice can be changed from the Voice Set function (page 91) and saved along with a User voice.

■ Sustain

When this feature is ON, all notes played on the upper section of the keyboard (RIGHT 1–3 parts) have a longer sustain. The Sustain level for each voice can be adjusted via the Voice Set function (page 91) and can be saved as a User voice.

■ Poly/Mono

This determines whether the part’s voice is played monophonically (only one note at a time) or polyphonically. When the lamp of the [MONO] button is on, the Portamento effect can be controlled (depending on the selected voice) by playing legato.

The Poly/Mono setting and the degree of the Portamento effect (Portamento Time) are pre-programmed for each voice. These can be changed via the Voice Set function (page 91) and saved as a User voice.

Portamento Time can also be adjusted from the Mixing Console (page 179).

■ DSP and DSP Variation

With the digital effects built into the Tyros2 you can add ambience and depth to your music in a variety of ways—such as adding reverb that makes you sound like you are playing in a concert hall.

- The [DSP] button turns the DSP (Digital Signal Processor) effect on or off for the currently selected keyboard part.
- The [DSP VARIATION] button lets you switch between two variations of the DSP effect. You could use this while you play, for example, to change the rotating speed (slow/fast) of the rotary speaker effect.

Changing Pitch on the Tyros2

The Tyros2 has a variety of pitch-related controls and functions, as described below.

■ PITCH BEND Wheel.....

Use the Tyros2 PITCH BEND wheel to bend notes up (roll the wheel away from you) or down (roll the wheel toward you) while playing the keyboard. The Pitch Bend is applied to all the keyboard parts (RIGHT 1–3 and LEFT). The PITCH BEND wheel is self-centering and will automatically return to normal pitch when released.

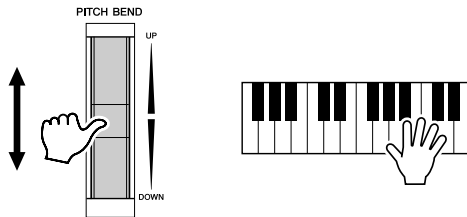

NOTE

- The maximum pitch bend range can be changed on the MIXING CONSOLE display (page 180).
- If the Pitch Bend range is set to more than 1200 cents (1 octave) via MIDI, the pitch of some voices may not be raised or lowered completely.

■ MODULATION Wheel

The Modulation function applies a vibrato effect to notes played on the keyboard. This is applied to all the keyboard parts (RIGHT 1–3 and LEFT).

Moving the MODULATION wheel down (towards MIN) decreases the depth of the effect, while moving it up (towards MAX) increases it.

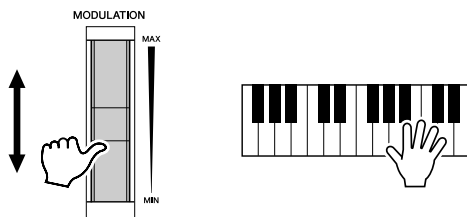

NOTE

- To avoid accidentally applying modulation, make sure the MODULATION Wheel is set at MIN before you start playing.
- The MODULATION Wheel can be set to control a different parameter other than vibrato (page 92).

■ Transpose

With this function, you can transpose the pitch of the Tyros2 up or down over a range of ± 2 octaves in semitone steps. Three transposing methods (Keyboard, Song, and Master) are available; select the desired method in the [FUNCTION] → CONTROLLER → KEYBOARD/PANEL display (page 191), then use the [TRANSCOPE] buttons to change the value.

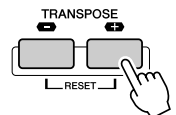

● Keyboard Transpose

The [TRANSCOPE] buttons affect the pitch of the keyboard sound, the style playback pitch, and the pitch of the Multi Pads for which Chord Match has been set to on. Note that the transposition is applied from the next note (or style chord) played, after one of the [TRANSCOPE] buttons has been pressed.

● Song Transpose

The [TRANSCOPE] buttons affect only song playback.

Note that the transposition is applied from the next note of song playback after one of the [TRANSCOPE] buttons has been pressed.

● Master Transpose

The [TRANSCOPE] buttons affect the overall pitch of the Tyros2.

Normal pitch (transpose value of “0”) can be recalled at any time by pressing both the [+] and [–] buttons simultaneously.

The transposition can be adjusted from the Mixing Console display (page 180).

■ Upper Octave.....

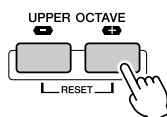

See page 27 in “Quick Guide.”

Organ Flutes (Footage Settings)

Quick Guide on page 28 →

The Tyros2 features a variety of lush, dynamic organ voices that you can call up with the [ORGAN FLUTES] button. It also gives you the tools to create your own original organ sounds by changing the footage settings. Just as on a traditional organ, you can create your own sounds by adjusting the levels of the flute footages. From these display you can also change the volume and effect settings.

Basic Procedure

1 Press the [ORGAN FLUTES] button to call up the Open/Save display for organ voices.

2 Press the [FOOTAGE] LCD button (upper [5] button) to call up the Footage display.

3 Select the desired menu with the [TAB] buttons and set the appropriate parameters.

4 Press the [SAVE] LCD button to call up the Open/Save display of the User drive and save the settings here as a User voice to the drive. For details, see page 75.

Adjust the footage.

The [1] buttons are used to adjust either the 16' or 5-1/3' footages. Select the desired footage here, then adjust it with the [1] buttons.

CAUTION
If you select another voice without saving the settings, the settings will be lost. If you wish to store the settings here, make sure to save the settings as a User Voice before selecting another voice or turning the power off.

Parameters

The Organ Flutes parameters are organized into three different pages, and can be set as described in step #3 of the “Basic Procedure” above. These can also be programmed as part of the Voice Set parameters (page 188), to be automatically called up when the voice is selected.

FOOTAGE

ORGAN TYPE	This LCD button specifies the type of organ tone generation to be simulated: Sine or Vintage.
ROTARY SP SPEED	This LCD button alternately switches between the slow and fast rotary speaker speeds when a rotary speaker effect is selected for the Organ Flutes (see “DSP Type” below), and the VOICE EFFECT [DSP] button is turned on (this LCD button has the same effect as the VOICE EFFECT [VARIATION] button).
VIBRATO ON/OFF	This LCD button alternately turns the vibrato effect for the Organ Flutes voice ON or OFF.
VIBRATO DEPTH	This LCD button sets the Vibrato depth to one of three levels: 1 (low), 2 (mid), or 3 (high).
16'–1' (Footage)	These LCD buttons determine the basic sound of the organ flutes. The term “footage” is a reference to the sound generation of traditional pipe organs, in which the sound is produced by pipes of different lengths (in feet). The longer the pipe, the lower the pitch of the sound. Hence, the 16' setting determines the lowest pitched component of the voice, while the 1' setting determines the highest pitched component. The higher the value of the setting, the greater the volume of the corresponding footage. Mixing various volumes of the footages lets you create your own distinctive organ sounds.

■ VOL/ATTACK

VOL (Volume)	Adjusts the overall volume of the Organ Flutes. The longer the graphic bar, the greater the volume.
RESP (Response)	Affects both the attack and release (page 93) portion of the sound, increasing or decreasing the response time of the initial swell and release, based on the FOOTAGE controls. The higher the value, the slower the swell and release.
VIBRATO SPEED	Determines the speed of the vibrato effect controlled by the Vibrato On/Off and Vibrato Depth above.
MODE	The MODE control selects between two modes: FIRST and EACH. In the FIRST mode, attack is applied only to the first notes played and held simultaneously; while the first notes are held, any subsequently played notes have no attack applied. In the EACH mode, attack is applied equally to all notes.
4', 2 2/3', 2'	These determine the attack sound volume of the ORGAN FLUTE voice. The 4', 2 2/3' and 2' controls increase or reduce the volume of attack sound at the corresponding footages. The longer the graphic bar, the greater the attack sound volume.
LENG (Length)	Affects the attack portion of the sound producing a longer or shorter decay immediately after the initial attack. The longer the graphic bar, the longer the decay.

■ EFFECT/EQ

REVERB DEPTH	See "Effect" on page 181.
CHORUS DEPTH	See "Effect" on page 181.
DSP DEPTH	See "Effect" on page 181.
DSP ON/OFF	See "Effect" on page 181.
DSP TYPE	Determines the DSP effect type to be applied to the Organ Flutes voice by selecting a Category and a type. If any other effect type than "Rotary Speaker" is selected, the [ROTARY SP SPEED] LCD button in the FOOTAGE page will not control rotary speaker speed. Instead, it will have the same effect as the VOICE EFFECT [DSP VARIATION] button.
VARIATION	<p>ON/OFF Turns the DSP Variation on or off for the selected organ voice.</p> <p>PARAMETER Indicates the parameter to which the variation is applied depending on the selected DSP type.</p> <p>VALUE Adjusts the degree of the DSP variation parameter.</p>
EQ LOW/HIGH	These determine the Frequency and Gain of the Low and High EQ bands.

Voice Editing (Voice Set)

The Tyros2 has a Voice Set feature that allows you to create your own voices by editing some parameters of the existing voices. Once you've created a voice, you can save it as a User voice to the User drive or external devices for future recall.

Basic Procedure

1 Select the desired voice (other than an Organ Flutes voice).

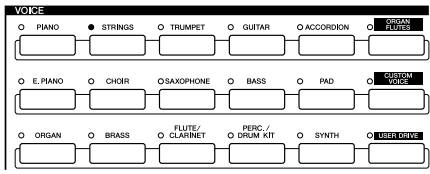

2 Press the [VOICE SET] LCD button (upper [5] button) to call up the Voice Set display.

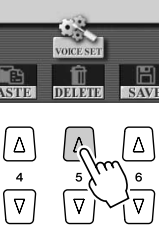

3 Select the desired menu with the [TAB] buttons and set the appropriate parameters.

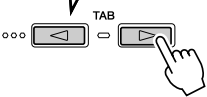

4 Press the [SAVE] LCD button to call up the Open/Save display of the User drive and save the settings here as a User voice to the drive. For details, see page 75.

NOTE

- User voices can also be created by editing Custom voices (created on a computer). You can also edit any previously created User voice to make a new voice.

CAUTION

If you select another voice without saving the settings, the settings will be lost. If you wish to store the settings here, make sure to save the settings as a User Voice before selecting another voice or turning the power off.

You can compare the sound of the original (unedited) voice with the edited voice.

Parameters

The Voice Set parameters are organized into five different pages, and can be set as described in step #3 of the “Basic Procedure” above. These can also be programmed as part of the Voice Set parameters (page 188), to be automatically called up when the voice is selected.

Keep in mind that these parameters do not apply to the Organ Flutes voices, which have their own set of parameters (page 89).

COMMON

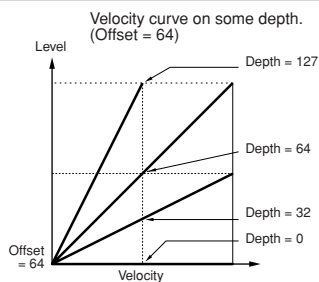
VOLUME	Determines the volume of the current edited voice.
TOUCH SENSE	<p>Depth determines the degree to which velocity affects the voice. Higher values make the voice more sensitive to changes in velocity. Offset determines the volume range over which velocity is effective. For lower values, the velocity affects a volume range from minimum to medium-loud. For higher values, velocity affects a range from medium-soft to maximum.</p>  <p>NOTE</p> <ul style="list-style-type: none"> This determines the volume range over which velocity is effective. For lower values, the velocity affects a volume range from minimum to medium-loud. For higher values, velocity affects a range from medium-soft to maximum.
OCTAVE	Shifts the octave range of the edited voice up or down in octaves. When the edited voice is used as any of the RIGHT 1–3 parts, the R1/R2/R3 parameter is available; when the edited voice is used as the LEFT part, the LEFT parameter is available.
MONO/POLY	Determines whether the edited voice is played monophonically or polyphonically (page 87).
PORTAMENTO TIME	Sets the portamento time when the edited voice is set to “MONO” above.

■ CONTROLLER

● MODULATION

The Modulation Wheel can be used to modulate the parameters below as well as the pitch (vibrato). Here, you can set the degree to which the Modulation wheel modulates each of the following parameters.

FILTER	Determines the degree to which the Modulation Wheel modulates the Filter Cutoff Frequency. See next page for details about Filter.
AMPLITUDE	Determines the degree to which the Modulation Wheel modulates the amplitude (volume).
LFO PMOD	Determines the degree to which the Modulation Wheel modulates the pitch, or the vibrato effect.
LFO FMOD	Determines the degree to which the Modulation Wheel modulates the Filter modulation, or the wah effect.
LFO AMOD	Determines the degree to which the Modulation Wheel modulates the amplitude, or the tremolo effect.

● AFTERTOUCH

Aftersustain can be used to modulate the parameters below. Here, you can set the degree to which Aftersustain modulates each of the following parameters.

FILTER	Determines the degree to which Aftersustain modulates the Filter Cutoff Frequency. See next page for details about Filter.
AMPLITUDE	Determines the degree to which Aftersustain modulates the amplitude (volume).
LFO PMOD	Determines the degree to which Aftersustain modulates the pitch, or the vibrato effect.
LFO FMOD	Determines the degree to which Aftersustain modulates the Filter modulation, or the wah effect.
LFO AMOD	Determines the degree to which Aftersustain modulates the amplitude, or the tremolo effect.

■ SOUND

● FILTER

Filter is a processor that changes the timbre or tone of a sound by either blocking or passing a specific frequency range. The parameters below determine the overall timbre of the sound by boosting or cutting a certain frequency range. In addition to making the sound either brighter or more mellow, Filter can be used to produce electronic, synthesizer-like effects.

BRIGHTNESS	Determines the cutoff frequency or effective frequency range of the filter (see diagram). Higher values result in a brighter sound.
HARMONIC CONTENT	<p>Determines the emphasis given to the cutoff frequency (resonance), set in BRIGHTNESS above (see diagram). Higher values result in a more pronounced effect.</p>

● EG (Envelope Generator)

The EG (Envelope Generator) settings determine how the level of the sound changes in time. This lets you reproduce many sound characteristics of natural acoustic instruments—such as the quick attack and decay of percussion sounds, or the long release of a sustained piano tone.

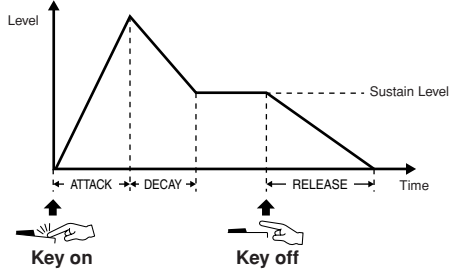
ATTACK	Determines how quickly the sound reaches its maximum level after the key is played. The higher the value, the slower the attack.
DECAY	Determines how quickly the sound reaches its sustain level (a slightly lower level than maximum). The higher the value, the slower the decay.
RELEASE	Determines how quickly the sound decays to silence after the key is released. The higher the value, the slower the release. 

● VIBRATO

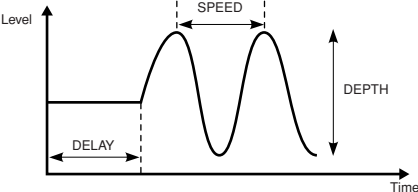
DEPTH	Determines the intensity of the Vibrato effect (see diagram). Higher settings result in a more pronounced Vibrato.
SPEED	Determines the speed of the Vibrato effect (see diagram).
DELAY	Determines the amount of time that elapses between the playing of a key and the start of the Vibrato effect (see diagram). Higher settings increase the delay of the Vibrato onset. 

■ EFFECT/EQ

Same as in “Organ Flutes” on page 90, with the exception of the PANEL SUSTAIN parameter, which determines the sustain level applied to the edited voice when turning the [SUSTAIN] button in the VOICE EFFECT section on.

■ HARMONY

Same as in the [FUNCTION] → HARMONY/ECHO display. See page 191.

Voice Creator—Custom Voice Edit

The powerful Voice Creator features of the Tyros2 give you the tools to create your own original voices from scratch. Voice Creator allows you to import your own audio samples and waveforms, and assign them to the keys—building completely new voices with completely new sounds. It also has a Voice Set function that lets you edit basic parameters for the voice, including filter, envelope and vibrato settings, as well as modulation assignments for the controllers and effect/EQ processing.

The resulting voice is called a Custom voice and can be selected and played in the same way as all other Tyros2 voices. You can save your original voices to a USB storage device or an installed hard disk drive, as well as the User drive. You can also edit Preset voices or Custom voices on a computer by using the Voice Editor software (contained in the included CD-ROM).

Creating a Voice—Basic Procedure

For this operation, you'll need some audio data. This could be a short waveform of an instrument sound, a recording of a voice (sung or spoken), or a rhythm loop. As long as the data is stored in WAV or AIFF format, you can import it to the Tyros2. (In the Voice Creator, "Wave" refers to both WAV and AIFF format data.) You can use a USB storage device (such as a USB flash memory) to store the audio data and import it to the Tyros2, or you can record/transfer the audio to an installed hard disk drive.

NOTE

- This instrument cannot recognize the extension *.aif*. When you use an AIFF file, change the extension to *.aif*.

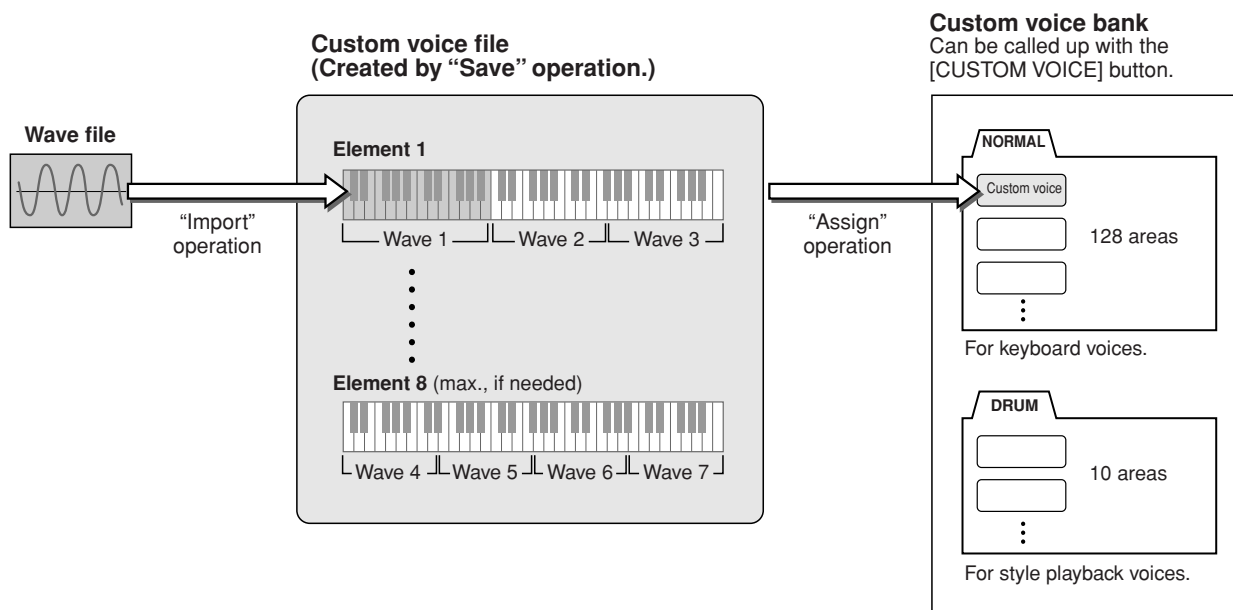

► 1 Prepare the audio data you'll be using for the new voice.

The easiest way to do this is on a computer, ideally with audio editing software. You can record your own sounds to the computer and edit them, or take existing sounds (from commercial sample libraries and the like).

If the audio data is on a USB storage device, connect the device to the USB TO DEVICE terminal.

▶ **2 Select a Custom voice.**

When you are creating a Custom voice from scratch, this step is not necessary. If you are creating a voice by editing an existing voice, press the [CUSTOM VOICE] button and select the desired voice.

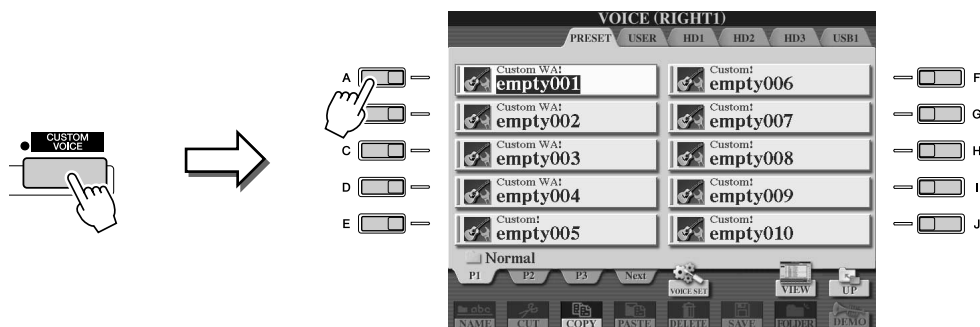

The Tyros2 has a Custom voice bank containing empty voices that can be used for this purpose. Select the PRESET tab, then select the desired voice number.

▶ **3 Press the [VOICE CREATOR] button to call up the Voice Creator.**

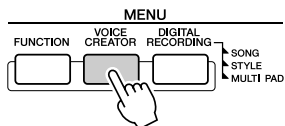

▶ **4 Call up the WAVE IMPORT menu by pressing the [A] button.**

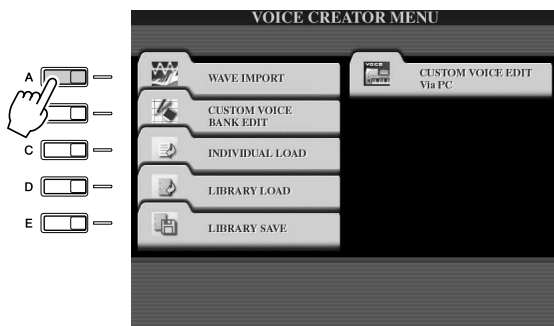

NOTE

• If you did not select a voice in step 2, a prompt appears letting you know an empty voice will be created. Select "OK" to create a new voice. When the new voice is created, playing the keyboard does not produce any sound.

▶ **5 Select the desired Element.**

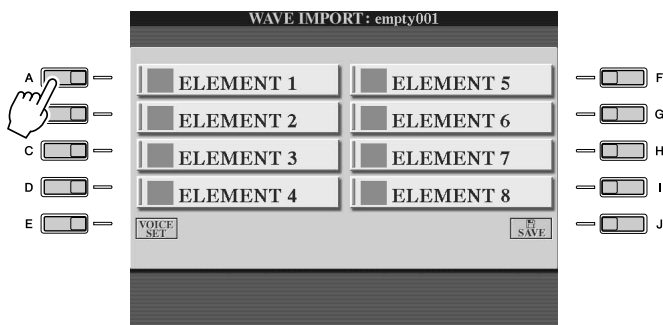

NOTE

• The created element can be edited by using the Voice Editor.

▶ **6** Press the [ADD WAVE] LCD button ([F] button).

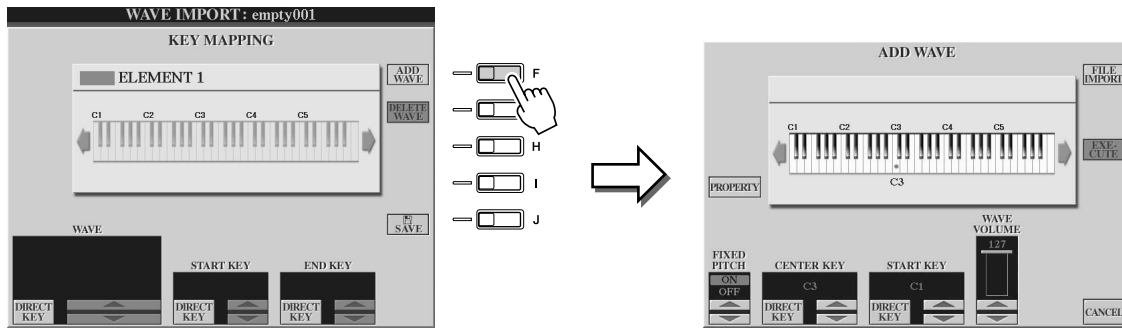

▶ **7** Make sure the storage device is installed or connected, then press the [FILE IMPORT] LCD button ([F] button).

NOTE

• For details on the Property display, see page 103.

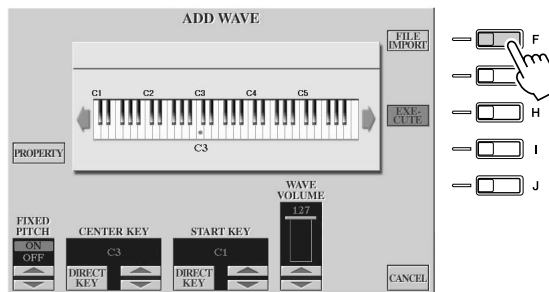

▶ **8** Select the desired audio file from the device.

All available .wav and .aif files will be shown. Use the [TAB] buttons and LCD buttons to select the appropriate device, folder and page, if necessary. The selected file name is highlighted.

NOTE

- Audio data used for the Voice Creator can be of any sample rate or bit resolution. However, all audio data of a resolution other than 16-bit is automatically converted to 16-bit resolution after being loaded.
- Voice Creator supports and recognizes loops in the audio data, letting you use up to one loop in each audio file. (Some sample libraries have loops already programmed into the data; you can also use audio editing software to program loops yourself. Keep in mind however, that multiple loops are not supported.)
- Audio files recorded with the Hard Disk Recorder cannot be used as is with the Voice Creator. If you want to use a Hard Disk Recorder file, export the file (using the Hard Disk Recorder's Export function) in .wav data format.

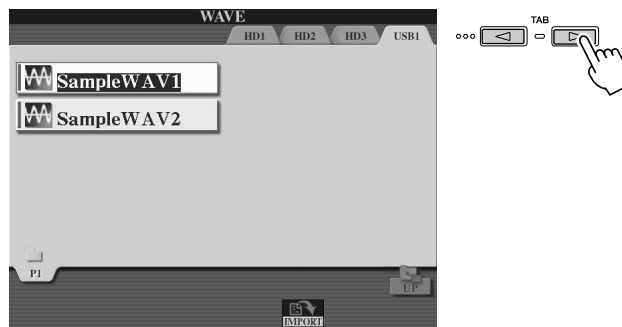

- ▶ **9** Press the [IMPORT] LCD button (lower [6] button).

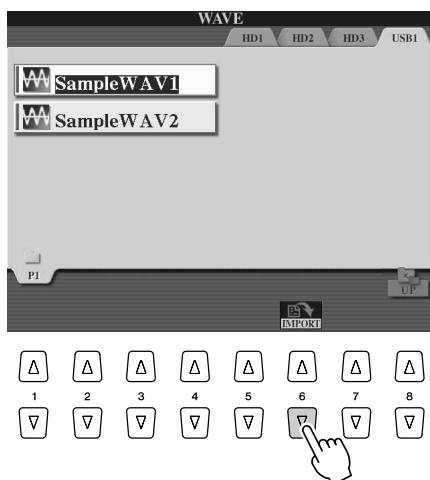

NOTE

- Double-clicking on the corresponding LCD button here selects the file for import, allowing you to skip Steps 9 and 10 below.
- The maximum number of Wave files that can be imported is 4,096 mono files or 2,048 stereo files. You can check the total number from the Property display (page 103).
- Only import Wave data having the following frequencies: 96000 Hz, 88000 Hz, 48000 Hz, 44100 Hz, 32000 Hz, 22050 Hz or 11025 Hz. Otherwise, the data may not play back at the correct pitch.

- ▶ **10** Press the [OK] LCD button (lower [7] button).

The file properties for the audio data are shown for confirmation purposes.

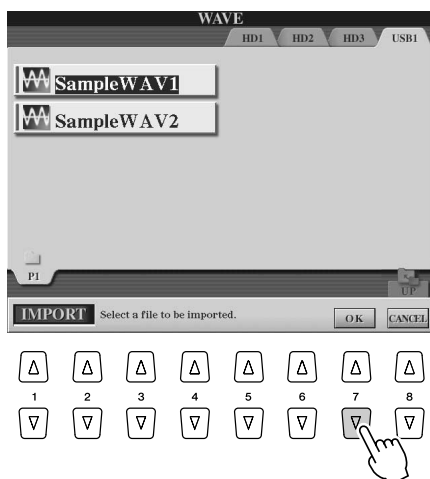

- ▶ **11** At the prompt, press the [YES] LCD button ([F] button).

To cancel, press the [NO] LCD button ([G] button).

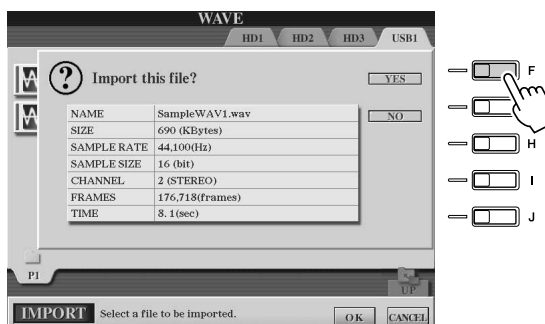

▶ 12 Set the parameters.

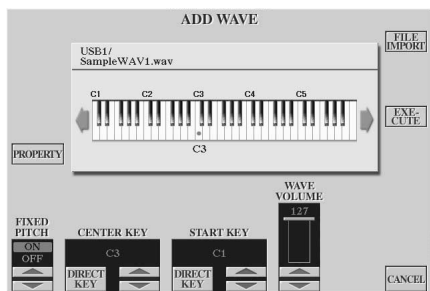

NOTE

- The Fixed Pitch, Center Key and Wave Volume cannot be changed after performing the next step. If you want to change the parameters after the next step, you will need to import the data again.

From this display, you can set a number of parameters related to how the sound will be mapped to the keyboard:

FIXED PITCH	When this is set to ON, all keys will play the wave sound at the same pitch. When set to OFF, the pitch of the wave sound changes according to the key played, based around the original pitch (set at Center Key below).
CENTER KEY	This determines the key to which the original pitch of the sound is assigned. When Fixed Pitch (above) is set to OFF, keys below the Center Key play the sound progressively lower in pitch, while keys above play the sound progressively higher. Normally, you'll want to make sure that this is the same as the original sound; for example, if the original pitch of the audio was at C3, set Center Key to C3 for best results. When Fixed Pitch (above) is set to ON, this has no effect.
START KEY	This determines the lowest key at which the wave will sound. Use this with End Key (see Step 12 below) to set the key range for the wave.
WAVE VOLUME	This determines the playback volume for the specific wave. Normally, this should be set to the maximum (127); however, you can use it to adjust the level balance among multiple sounds in the Element.

You can change the key settings (Center Key and Start Key) in three ways:

- By using the corresponding upper/lower LCD buttons (button pairs [3] and [5]).
- By using the DATA ENTRY dial (after pressing one of the corresponding [2]–[5] LCD buttons)
- By simultaneously holding down the [DIRECT KEY] LCD button ([2] or [4] button) and pressing the desired key on the keyboard.

▶ 13 Press the [EXECUTE] LCD button ([H] button).

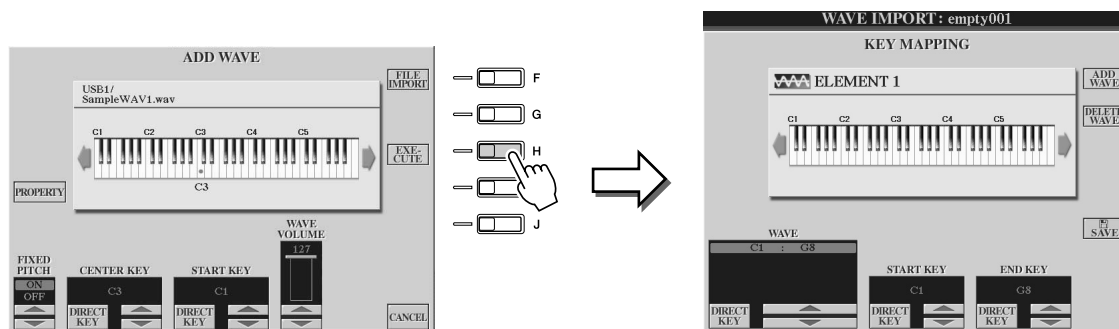

From the KEY MAPPING display you can set:

WAVE	This is only available when more than one wave has been imported. With multiple waves available, you can select the desired one for editing.
START KEY	This determines the lowest key at which the wave will sound. Use this with End Key (below) to set the key range for the wave.
END KEY	This determines the highest key at which the wave will sound. Use this with Start Key (above) to set the key range for the wave.

You can change the settings in three ways:

- By using the corresponding upper/lower LCD buttons.
- By using the [DATA ENTRY] dial (after pressing one of the corresponding [1]–[7] LCD buttons)
- By simultaneously holding down the [DIRECT KEY] LCD button and pressing the desired key on the keyboard.

When you want to delete Wave, select the Wave to be deleted from the “WAVE” parameter in the KEY MAPPING display and press the [DELETE WAVE] LCD button.

▶ 14 Edit the voice by using the Voice Set parameters.

Before saving, edit the parameters of your new voice.

- 1) Press the [EXIT] button to show the WAVE IMPORT display.
- 2) Press the [VOICE SET] LCD button ([E] button).

For details on the Voice Set parameters, refer to the section “Editing a Voice” on page 91.

- 3) Press the [EXIT] button to show the WAVE IMPORT display again.

▶ 15 Save and assign the newly created voice.

Press the [SAVE] LCD button ([J] button). The Save operation is actually a two-step process:

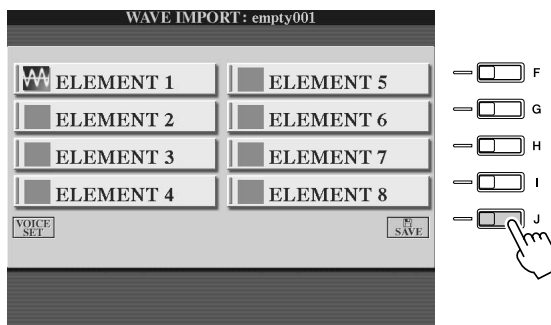

⚠ CAUTION

- *The created voice will be lost if you change to another voice or you turn the power off without executing the save operation. Make sure to execute the save operation.*

Step 1—Save the voice to a storage device

This step ensures that the data will be available, even in the event of a power failure or accidental shut down.

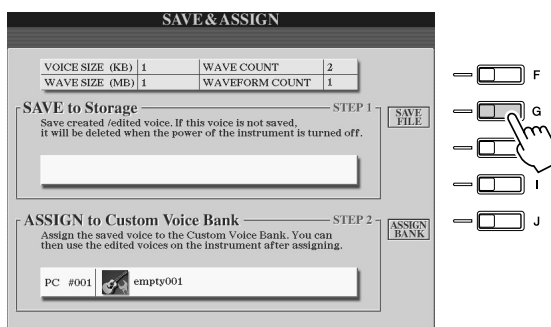

- 1) Press the [SAVE FILE] LCD button ([G] button).
- 2) Select the location and folder, using the [TAB] buttons and LCD buttons. Create a folder if necessary by pressing the [FOLDER] LCD button (lower [7] button).
- 3) Press the [SAVE] LCD button (lower [6] button).
- 4) Enter a name for the voice. (See page 76.)
- 5) Press the [OK] LCD button (upper [8] button).

📌 NOTE

- *Each time you add a Wave to the Element (or add an Element to the voice), you should save the voice. Simply keep the same name for the voice, and overwrite the data each time. (At the confirmation prompt, select [YES] with the [F] button.)*
- *Saving the voice to the USER drive is not recommended since the USER drive does not have much memory space—only about 3 MB.*
- *Do not use any special characters (umlaut, accent, etc.) in the voice name.*

Step 2—Assign the voice to a Custom voice bank

This step assigns the saved voice to the Custom voice bank, letting you select and play it in the same way you do with other voices. In this step, the link between the Custom voice bank and the saved voice is actually stored.

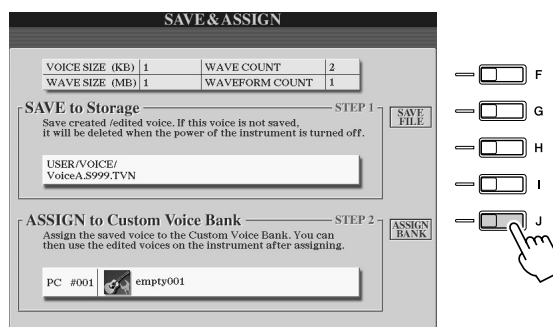

- 1) Press the [ASSIGN BANK] LCD button ([J] button).
- 2) Select the desired location in the bank, using the LCD buttons. (Use the upper LCD buttons [1]–[7] to select different pages in the bank.)
- 3) Press the [ASSIGN] LCD button (lower [6] button).
- 4) The same voice name that you entered in the Save operation above is selected automatically. Normally, you should keep this name. If you want to change it, see page 76 for instructions on naming.
- 5) Press the [OK] LCD button (upper [8] button).

The voices which have been saved and assigned are automatically loaded to the internal memory when the power of the instrument turned on. If the voice is contained in a USB storage device, automatic loading may not be possible because of the time needed to recognize the device. If this happens, copy the voice to another device and try it again.

► 16 Add waves to the selected element, if necessary.

Press the [EXIT] button to return to the WAVE IMPORT display and repeat steps 6–15. Make sure to save your voice data each time you make changes to it.

NOTE

- When the available memory space has been taken up with large amounts of audio data, you may want to delete large Custom voices to create space, yet not know which voices are large and taking up much space. In general, the longer the playback time of a Custom voice or the more WAVES the voice has, the more memory space it takes up. If possible delete these larger voices to free up space.

Creating another Custom voice

When you create another Custom voice from scratch after creating one Custom voice, press one of the voice category buttons (except for the Custom voice button) and press the [VOICE CREATOR] button to select the WAVE IMPORT menu. If you select the WAVE IMPORT menu after creating a Custom voice without selecting another voice, you cannot create another Custom voice—just add another element in the current Custom voice.

Editing a Custom Voice on the Tyros2—Voice Set

Once you've imported audio data and created a Custom voice with the Voice Creator features, you can use the Voice Set function on the Tyros2 to finish editing your new voice. While Voice Creator lets you import audio data and create the Elements for the voice, Voice Set provides all of the other parameters that you need to customize the voice and make it ready for playing.

NOTE

- If you have a computer, you can also use the Voice Editor software to edit Custom voices. (For details, see page 111.)

▶ 1 Select a Custom voice.

Press the [CUSTOM VOICE] button and select the desired voice.

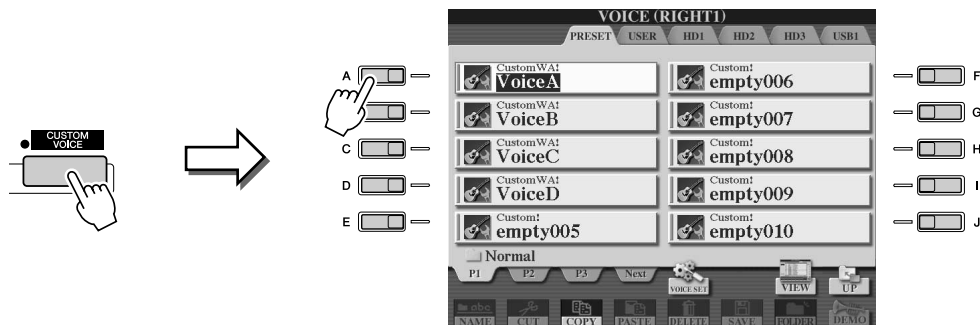

▶ 2 Press the [VOICE SET] LCD button (upper [5] button), and use the Voice Set controls to edit the voice.

For details on using Voice Set, see page 91.

NOTE

- If you save the data after setting the Voice Set parameters, the saved file contains only the Voice Set parameter settings and the path of the original voice—and does not contain the voice data itself. This means that if you change the location of the original voice, the saved file will sound a different voice.



Editing a Custom Voice Bank—Custom Voice Bank Edit

This function lets you organize the voices in the Custom voice bank, renaming them, changing their location within in the bank, or even deleting them if desired.

- ▶ **1** Press the [VOICE CREATOR] button to call up the Voice Creator.

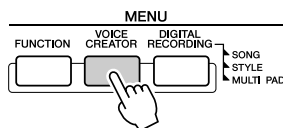

- ▶ **2** Call up the CUSTOM VOICE BANK EDIT menu by pressing the [B] button.

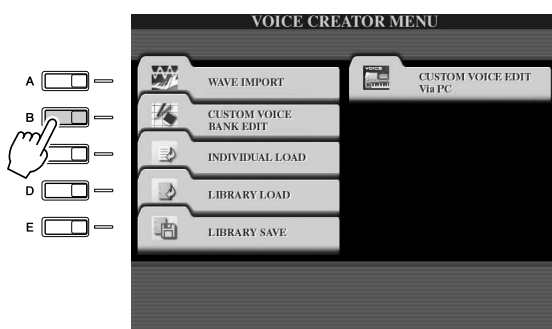

- ▶ **3** Select the **NORMAL** or **DRUM** tab, and select the desired page within the Custom voice bank.

All available Custom voices will be shown. Use the [TAB] buttons to select the voice type (Normal or Drum), and use the LCD buttons to select the desired page, if necessary. The Normal folder contains the voices which are used to play the keyboard. The Drum folder contains the voices which are used in playing back styles. You cannot create the DRUM voices by editing the Wave data; you can only create them by editing the drum voices in the PRESET drive. You can use the DRUM voices by replacing them in styles from the CHANNEL ON/OFF display (page 37).

- ▶ **4** Use the controls in the display to rename and reorganize the voices in the bank as desired.

When you reorganize voices in this display, you are simply organizing the paths of the voices, not copying or moving the voices themselves.



For reloading the Custom voice bank. This is used when the links of the voices are broken. For example, when you open this display without connecting the USB storage device which contains the assigned Custom voice, a "Not Found!" message appears along with the voice name. If this happens, connect the appropriate USB storage device and reload the Custom voice bank.

Calls up the Property popup display for the selected voice. (Page 103)

See pages 74–76.

■ Property display

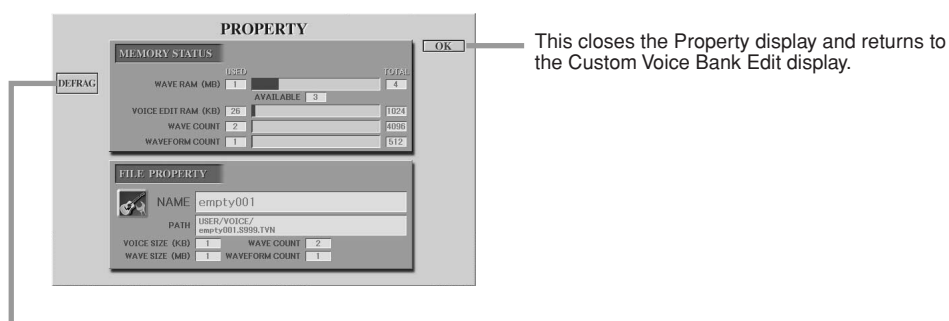

This closes the Property display and returns to the Custom Voice Bank Edit display.

This optimizes the DIMMs by defragmenting the wave file information in the memory. After defragmenting, the WAVE RAM size will be reduced.

When the “memory full” prompt appears, use this Property display to find out which voices are taking up large amounts of memory space and should be deleted or moved.

● Memory Status

WAVE RAM	Memory size of the optionally installed DIMMs. After installing the DIMMs, the pre-installed memory (4 MB) is invalid and cannot be accessed.
VOICE EDIT RAM	Size of the internal memory for the Voice Creator. Since this is used for the structure of the Custom voices, voices which contain many elements or wave data will greatly decrease this amount. This memory cannot be expanded. A maximum of 1,024 KB is available.
WAVE COUNT	Total number of the wave files. A maximum of 4,096 mono files or 2,048 stereo files is available.
WAVEFORM COUNT	Total number of Waveforms. The term Waveform refers to a set of wave assignment information. A maximum of 512 waveforms is available.

● File Property

NAME	Name of the file.
PATH	Location of the file.
VOICE SIZE	Size of the Custom voice.
WAVE SIZE	Total wave size in the voice.
WAVE COUNT	See Memory Status list above.
WAVEFORM COUNT	

Loading a single Custom Voice to the Tyros2—Individual Load

This operation allows you to load a single Custom voice to the Custom voice bank in the instrument for playing or editing.

- ▶ **1** Press the [VOICE CREATOR] button to call up the Voice Creator.

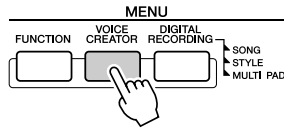

- ▶ **2** Call up the INDIVIDUAL LOAD menu by pressing the [C] button.

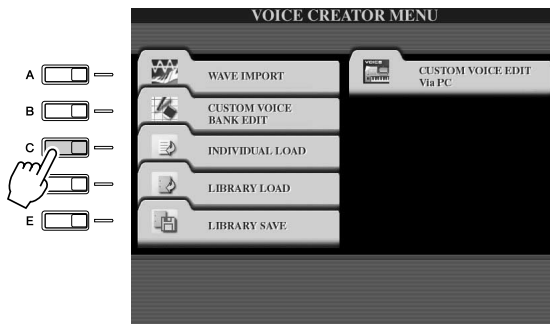

- ▶ **3** Select the location or device containing the desired Custom voice by using the [TAB] buttons.

If, for example, you have a hard disk drive installed and a USB storage device connected to the Tyros2, there will be three choices: USER, HD1, and USB1.

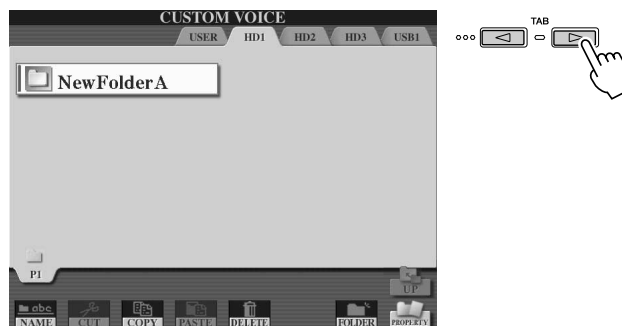

- ▶ **4** Select the desired Custom voice by pressing the corresponding LCD button.

All available Custom voices at the location will be shown. Use the LCD buttons to select the desired page, if necessary. The selected voice name is highlighted.

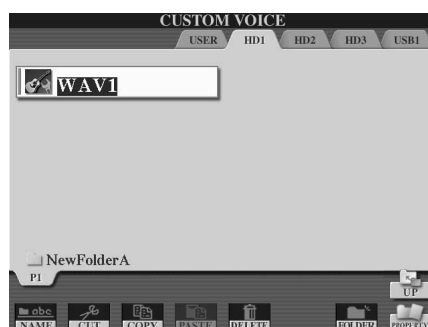

▶ **5 Select the destination for the voice.**

The Custom voice bank appears, letting you select a specific location for the individual voice. Use the upper LCD buttons to select the desired page, if necessary.

▶ **6 Press the [ASSIGN] LCD button (lower [6] button).**



▶ **7 Enter a name for the voice, if desired.**

If a Custom voice with the same name already exists in the bank, you'll need to enter a new name for the voice. For specific instructions on naming, see page 76.

▶ **8 Press the [OK] LCD button (upper [8] button).**

To cancel, press the [CANCEL] LCD button (lower [8] button).

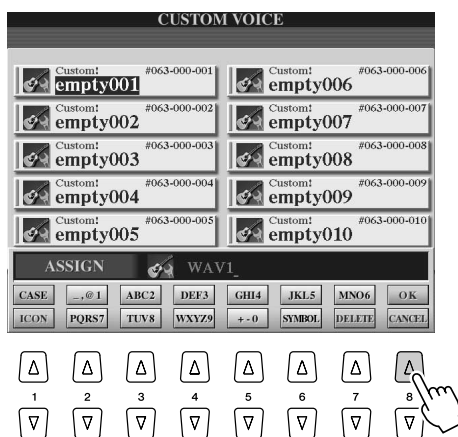

NOTE

- File loading may take as little as a couple of seconds or as long as a few minutes, depending on how much data is contained in the voice.

▶ **9 When you press the [CUSTOM VOICE] button, the newly loaded Custom voice will be available.**

Loading a Custom Voice Library to the Tyros2—Library Load

This operation lets you recall the Custom voices you've saved to a Library file (in Library Save on page 108), and load them to the Tyros2.

- ▶ **1** Press the [VOICE CREATOR] button to call up the Voice Creator.

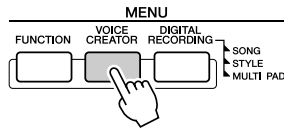

- ▶ **2** Call up the LIBRARY LOAD menu by pressing the [D] button.

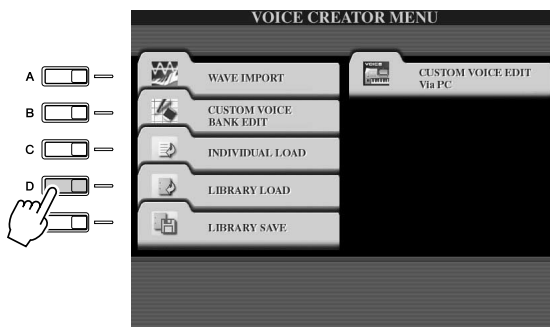

- ▶ **3** Select the location or device containing the desired Custom voice Library by using the [TAB] buttons.

If, for example, you have a hard disk drive installed and a USB storage device connected to the Tyros2, there will be three choices: USER, HD1, and USB1.

- ▶ **4** Select the desired Library file by pressing the corresponding LCD button.

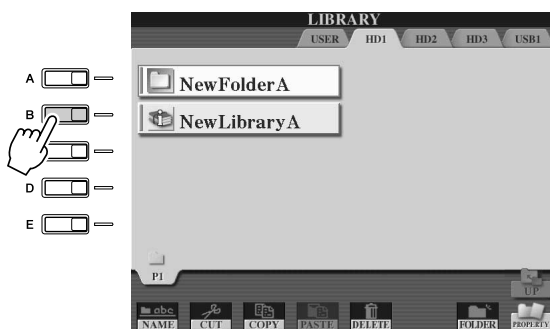

▶ 5 Load the library file.

If the instrument does not contain library files, the selected file is automatically loaded.
If the instrument contains library files, a “Load” prompt appears.

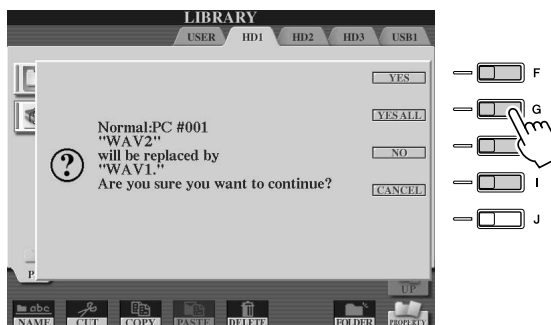

NOTE

- File loading may take several minutes, depending on how many Custom voices are in the Library and how much data they contain. Do not turn off the power or disconnect any devices during this operation.

YES	Current Custom voices are replaced with the ones in the library file one by one.
YES ALL	Current Custom voices are replaced with all of the voices in the library file. You can use this after replacing some voices one by one by using “YES” and replace all the rest.
NO	The displayed voice in the prompt will not be replaced.
CANCEL	Cancels loading the library file.

▶ 6 Press the [EXIT] button repeatedly to return to the MAIN display.

▶ 7 When you press the [CUSTOM VOICE] button, the newly loaded Custom voices will be available.

Saving your Custom Voices to a Library—Library Save

Once you've created some Custom voices, you'll want to keep them together in a Library file. Library Save lets you create a Library file for storing your Custom voices and keeping them organized for future use.

- ▶ **1** Press the [VOICE CREATOR] button to call up the Voice Creator.

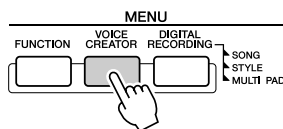

- ▶ **2** Call up the LIBRARY SAVE menu by pressing the [E] button.

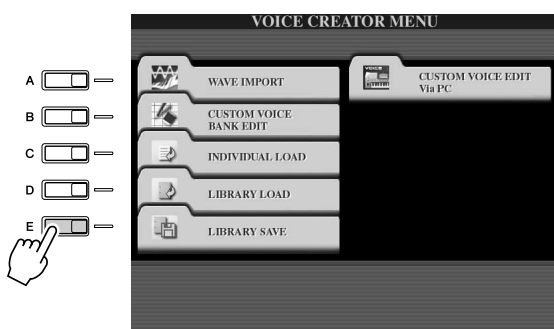

- ▶ **3** Select the NORMAL or DRUM tab.

The Normal folder contains the voices which are used to play the keyboard. The Drum folder contains the voices which are used in playing back styles. You cannot create the DRUM voices by editing the Wave data; you can only create them by editing the drum voices in the PRESET drive. You can use the DRUM voices by replacing them in styles from the CHANNEL ON/OFF display (page 37).

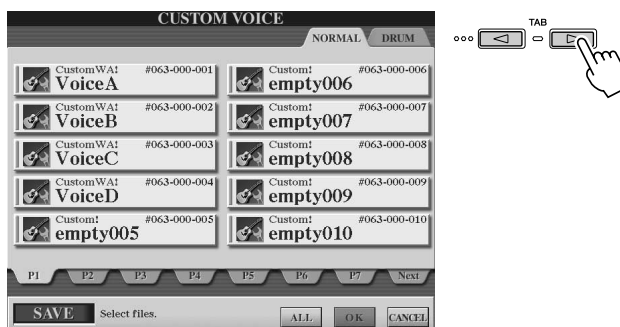

- ▶ **4** Select the desired Custom voice.

All available Custom voices will be shown. Use the LCD buttons to select the desired page, if necessary. The selected voice name is highlighted.

You can continue to select additional Custom voices here, as many as desired—even a mixture of Normal and Drum voices. If multiple pages (tabs) are shown at the bottom, you can select voices from these displays, too.

To select all available Custom voices, press the [ALL] LCD button (lower [6] button). When you select [ALL], all voices both in the NORMAL and DRUM tabs will be selected.

- ▶ **5** Press the [OK] LCD button (lower [7] button).



- ▶ **6** Select the destination for saving the data by using the [TAB] buttons.

If, for example, you have a hard disk drive installed and a USB storage device connected to the Tyros2, there will be three destination choices: USER, HD1, and USB1. Create a folder if necessary by pressing the [FOLDER] LCD button (lower [7] button).

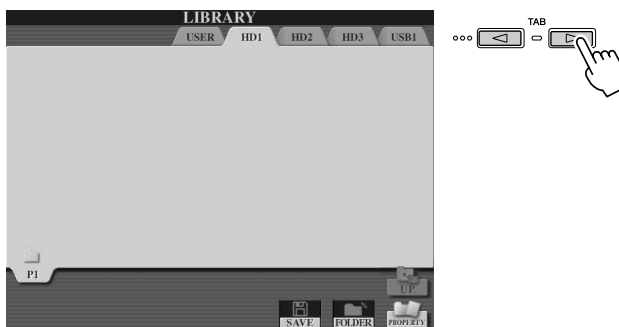

NOTE

- Even though the User drive can be selected here, there is not enough memory space in the drive for storing Voice Creator data. Make sure to use one of the other destinations.

NOTE

- **Checking the storage capacity**
• Before attempting to store data to the selected storage destination, you may want to check to see if there is enough available memory space for the operation. Pressing the [PROPERTY] LCD button (lower [8] button) here calls up the Property display for the selected storage location/device, and shows the overall capacity as well as the amount of free space available for storing your data.

- ▶ **7** Press the [SAVE] LCD button (lower [6] button).

- ▶ **8** Enter the desired name for the Library file and press the [OK] LCD button (upper [8] button).

For specific instructions on naming, see page 76.



▶ **9** At the “Save” prompt, press the [ALL DATA] LCD button ([F] button) to save all selected Custom voices to the specified destination.

Alternately, press the [ALIAS] LCD button ([G] button) to save an Alias marker for the data (see below), or press the [CANCEL] LCD button ([H] button) to cancel the operation.

- **ALL DATA** Saves all of the selected data to the specified location. In this operation, two kinds of data are saved—that of Library files and the selected Custom voices. These two kinds of files are saved to the same drive but are shown in different Open/Save displays.

Example of saving a library file with the “ALL DATA” selection to hard disk, using the Custom voices in a USB storage device

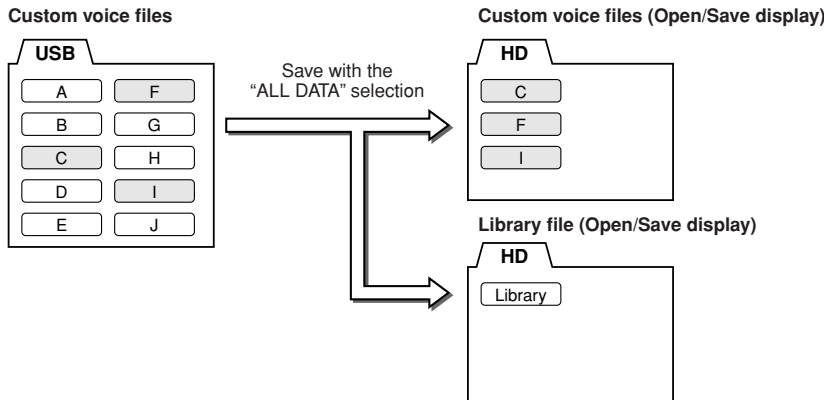

- **ALIAS** Saves only Alias markers (shortcuts) of the selected data to the specified location. This lets you save multiple Libraries of your voice data and make multiple folders containing different collections of your voices, without taking up additional memory space on the drive. As long as the voice data exists in one location on the drive, you can save an Alias that will recall that data.

Example of saving a library file with the “ALIAS” selection, using the Custom voices in a USB storage device

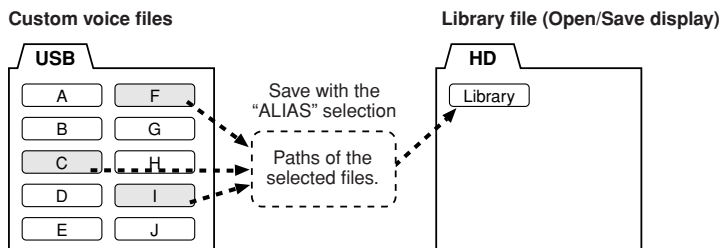

- **CANCEL** Cancels the save operation.

NOTE

- The Library file contains the path of the Custom voices. Therefore, if you move or delete the voices after creating the Library file, the voices cannot be recalled from the Library file. Moving the library file, however, does not affect the recalling of voices.

NOTE

- When you save the library file using ALL DATA, you should make a new folder to save the library because the Custom voices are mixed with the existing voices in the destination drive.

NOTE

- When you save a voice to some libraries by using ALIAS and edit the voice, the edit you perform affects all libraries which include the edited voice.

To confirm whether or not the Library data was properly saved:

- 1) Go to the main Voice Creator display (press the [VOICE CREATOR] button if necessary).
- 2) Call up the LIBRARY LOAD menu by pressing the [D] button.
- 3) Select the appropriate storage location with the [TAB] buttons. (For example, if you saved the data to a USB device, make sure the device is connected and select “USB1.”)

The Library file you saved should appear in the display.

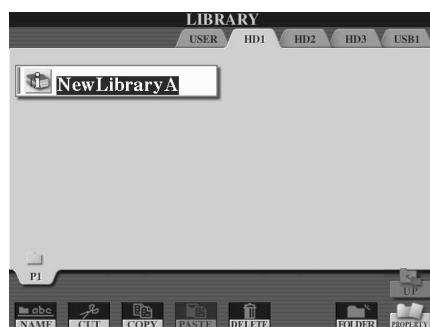

Editing a Custom Voice on your computer—Voice Editor

Once you've created a Custom voice with the Voice Creator features, you can transfer that voice to a computer and use the comprehensive Voice Editor software (included on the CD-ROM) to edit all the parameters from your computer. The voices you create can be saved to the PRESET drive on the Tyros2 as Custom voices, and can be called up any time by pressing the [CUSTOM VOICE] button. After installing the software, edit voices by following the steps below.

- ▶ **1 Turn the computer's power on, then turn the Tyros2's power on.**
- ▶ **2 Start Voice Editor on the computer.**

The Custom Voice Edit Mode display is shown in the instrument. If this display does not appear, press the [VOICE CREATOR] button and select "Custom Voice Edit via PC" to show this display.

The Voice Editor can only be used when this display is shown.

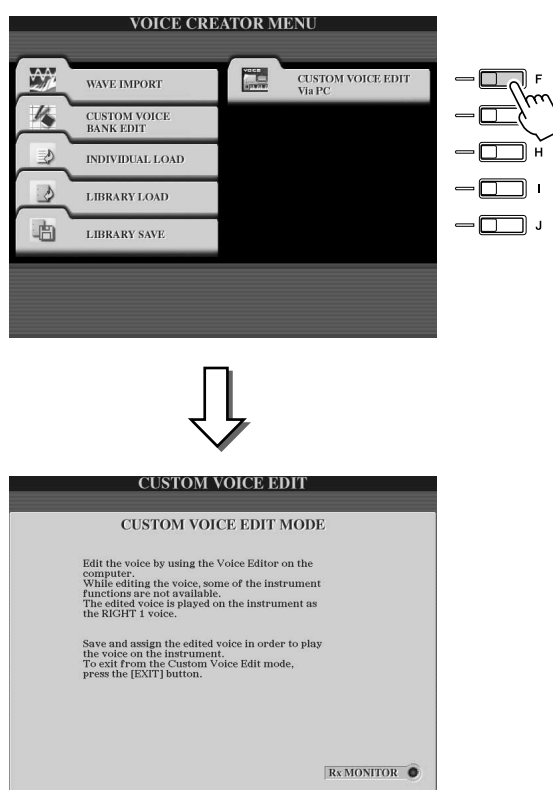

- ▶ **3 Edit the voice parameters on the computer to create your original voice.**
For details, refer to the Voice Editor documentation on the included CD-ROM.
- ▶ **4 When you've finished editing, save and assign the edited voice on the Tyros2.**
- ▶ **5 Exit the Voice Editor.**
- ▶ **6 Press the [CUSTOM VOICE] button and play your Custom voice.**

Song Playback

Quick Guide on page 43 ➔

The song playback features of the Tyros2 let you play MIDI song (sequence) data. This includes commercially available song data on floppy disk (GM- or XG-compatible), and performances you've recorded yourself with the Song Recording features (page 55) and saved to one of the drives. In addition, the Tyros2 can display music notation and lyrics, and you can use the sophisticated Guide functions to practice the keyboard and your singing as well. This section explains detailed settings about song playback that are not covered in "Quick Guide."

Displaying Music Notation

To view the music notation of the selected song, press the [SCORE] button. This lets you read the music while the song plays back. That's not all, though; there's much more you can do:

- Read the score while the song is stopped and practice it on your own.
- Use the notation to practice playing just the melody part, while the accompaniment provides the backing. Simply turn off the right-hand part (channel) from the display.
- If the song has lyric data, you can read the lyrics from the display and sing along while the song plays. Connect a microphone and you can even have your voice mixed with the song as it plays.
- With the sophisticated Guide features, you can let the Tyros2 "teach" you how to play the song properly—and even how to sing it with the correct pitches.

Basic Procedure (Score)

1 Select a song.

2 Press the [SCORE] button.

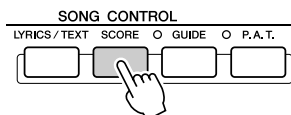

3 As the song plays back, a red "ball" bounces along through the score, indicating the current position.

To select different pages, use the [TAB] buttons.

NOTE

- An optional foot pedal can also be used to turn pages (page 189).



4 Set the parameters of the view type as required.

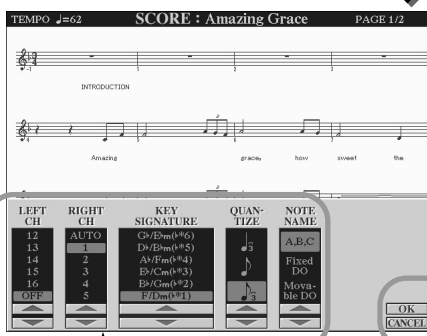

5 Set the detailed parameters of the view type as required.

NOTE

- The displayed notation is generated by the Tyros2 based on the song MIDI data. As a result, it may not be exactly the same as commercially available sheet music of the same song—especially when displaying notation of complicated passages or many short notes.
- Some song data has been recorded with special "free tempo" settings. For such song data, the tempo, beat, measure and music notation will not be displayed correctly.
- If all of the notes in a certain measure cannot fit in one line, the measure is extended to the next line.
- The notation functions cannot be used to create song data by inputting notes. For information on creating song data, see page 127.
- You can increase the number of measures that will be displayed by decreasing the other items to be displayed (parts, lyrics, chords, etc.).

■ Notation View parameters (Step #4 on the previous page)

LEFT	Enables/disables display of the left-hand key range. Depending on other settings, this parameter may be unavailable and may appear grayed out. If this is the case, go to the detailed setting display (described below; step #4 on the previous page) and set the LEFT CH. parameter below to any channel except "AUTO." Or, go to the [FUNCTION] → SONG SETTING display (page 118) and set the LEFT parameter to any channel except "OFF." RIGHT (next parameter) and LEFT cannot be turned off at the same time.
RIGHT	Enables/disables display of the right-hand key range. Channel 1 is automatically selected when the LEFT CH. parameter below is set to any channel except "AUTO" or [RIGHT] is set to [OFF] from the [FUNCTION] → SONG SETTING display (page 118). RIGHT and LEFT (above) cannot be turned off at the same time.
CHORD	Enables/disables display of the chords. If the selected song does not contain chord data, chords are not displayed.
LYRICS	Enables/disables display of the lyrics. If the selected song does not contain lyric data, lyrics are not displayed.
NOTE	Enables/disables display of the note name (pitch). The note name is indicated at the left of the note. When the space between the notes is too small, the indication may be moved to the top left of the note.
COLOR	When this is set to ON, the notes in the display appear in color (C: red, D: yellow, E: green, F: orange, G: blue, A: purple, and B: gray).
SIZE	Determines the display resolution (or zoom level) of the notation.

■ Notation View detailed parameters (Step #5 on the previous page)

LEFT CH (channel)/RIGHT CH (channel)	<p>Determines which MIDI channel in the song data is used for the left-hand/right-hand part. This setting returns to AUTO when a different song is selected.</p> <p>AUTO The MIDI channels in the song data for the right- and left-hand parts are assigned automatically—setting the parts to the same channel as the channel which is specified in the [FUNCTION] → SONG SETTING display (page 118).</p> <p>1-16 Assigns the specified MIDI channel (1–16) to each of the left- and right-hand parts.</p> <p>OFF (LEFT CH only) No channel assignment—this disables display of the left-hand key range.</p>																																								
KEY SIGNATURE	This lets you enter key signature changes in the middle of a song, at the stopped position. This menu is useful when the selected song contains no key signature settings for displaying notation.																																								
QUANTIZE	This gives you control over the note resolution in the notation, letting you shift or correct the timing of all displayed notes so that they line up to a particular note value. Make sure to select the smallest note value which is used in the song.																																								
NOTE NAME	<p>Selects the type of the note name indicated at the left of the note in the notation from among the following three types. The settings here are available when the NOTE parameter above is set to ON.</p> <p>A, B, C Note names are indicated as letters (C, D, E, F, G, A, B).</p> <p>FIXED DO Note names are indicated in solfeggio and differ depending on the selected language (page 23).</p> <table style="margin-left: 40px;"> <tr> <td>English</td> <td>Do</td> <td>Re</td> <td>Mi</td> <td>Fa</td> <td>Sol</td> <td>La</td> <td>Ti</td> </tr> <tr> <td>German</td> <td>Do</td> <td>Re</td> <td>Mi</td> <td>Fa</td> <td>Sol</td> <td>La</td> <td>Si</td> </tr> <tr> <td>French</td> <td>Ut</td> <td>Re</td> <td>Mi</td> <td>Fa</td> <td>Sol</td> <td>La</td> <td>Si</td> </tr> <tr> <td>Spanish</td> <td>Do</td> <td>Re</td> <td>Mi</td> <td>Fa</td> <td>Sol</td> <td>La</td> <td>Si</td> </tr> <tr> <td>Italian</td> <td>Do</td> <td>Re</td> <td>Mi</td> <td>Fa</td> <td>Sol</td> <td>La</td> <td>Si</td> </tr> </table> <p>MOVABLE DO Note names are indicated in solfeggio according to the scale intervals, and as such are relative to the key. The root note is indicated as Do. For example, in the key of G major the root note of Sol would be indicated as Do. As with "Fixed Do," the indication differs depending on the selected language.</p>	English	Do	Re	Mi	Fa	Sol	La	Ti	German	Do	Re	Mi	Fa	Sol	La	Si	French	Ut	Re	Mi	Fa	Sol	La	Si	Spanish	Do	Re	Mi	Fa	Sol	La	Si	Italian	Do	Re	Mi	Fa	Sol	La	Si
English	Do	Re	Mi	Fa	Sol	La	Ti																																		
German	Do	Re	Mi	Fa	Sol	La	Si																																		
French	Ut	Re	Mi	Fa	Sol	La	Si																																		
Spanish	Do	Re	Mi	Fa	Sol	La	Si																																		
Italian	Do	Re	Mi	Fa	Sol	La	Si																																		

Displaying Lyrics

If the selected song has lyric data, you can have the lyrics shown in the display by pressing the [LYRICS/TEXT] button. The Lyrics feature offers a number of useful possibilities:

- The phrases to be sung are highlighted in time with the music, making it easy to follow the words and sing along with the song. Connect a microphone and you can even have your voice mixed with the song accompaniment as it plays.
- Connect an external monitor to the Tyros2, and you can have the lyrics displayed on the monitor—for group sing-alongs and the like. You can even set the Tyros2 so that the lyrics are shown on the monitor while the LCD of the instrument displays a different operation or function. (Select [FUNCTION] → SCREEN OUT.)

Basic Procedure (Lyrics)

- 1** Select a song.
- 2** Press the [LYRICS/TEXT] button.
- 3** As the song plays back, the lyrics are shown in succession in the LCD display.

To select different pages, use the [TAB] buttons.

NOTE
• An optional foot pedal can also be used to turn pages (page 189).

Various text-related settings can be made from this display.

TEXT	Switches the screen to the Text display. For more on the Text display, see “Displaying Text” on page 115.
TEXT FILE	Calls up the Open/Save display for selecting a text file. After setting, press the [EXIT] button to return back to the Lyrics display. For more on the Text display, see “Displaying Text” on page 115.
BACKGROUND	This lets you change the background picture of the Lyrics display. The Open/Save display is called up, letting you select a picture file via this parameter. After making the setting, press the [EXIT] button to return back to the Lyrics display.

NOTE

- The language used for lyrics display depends on the particular lyric data. If the lyrics are garbled or unreadable, you can remedy this by changing the “LYRICS LANGUAGE” setting from the [FUNCTION] → SONG SETTING display.
- When the background color is specified in the song data, the BACKGROUND setting cannot be changed.
- If the selected song does not contain lyric data, lyrics are not displayed.
- If the selected song contains chord data, chord names are displayed with the lyrics.

Displaying Text

This feature lets you show text files (created on a computer) in the display of the Tyros2, opening up a number of useful possibilities:

- You can input and show the lyrics, even if the song does not contain lyrics data.
- You can show any kind of text—not only lyrics, but also lyrics with chord names, notes or tips.
- Connect an external monitor to the Tyros2 and you can have the text displayed on the monitor as can be done in the Lyrics display.

Basic Procedure (Text)

- 1** Connect the device containing the text file to be shown in the display.
- 2** Press the [LYRICS/TEXT] button.

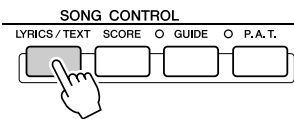
- 3** Press the [5]/[6] buttons.

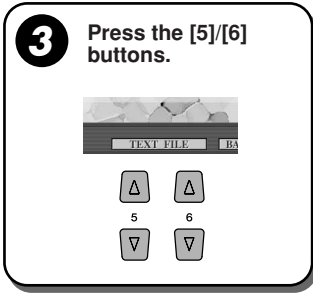
- 4** Select a text file and display the text.

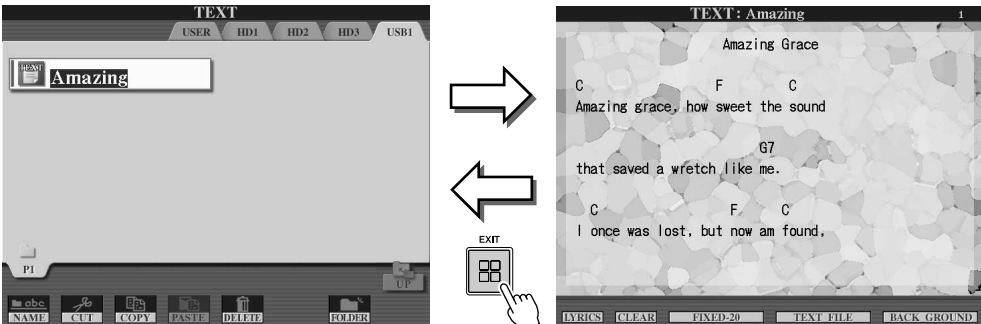

If the text is long, use the [TAB] buttons to turn pages.

NOTE
• An optional foot pedal can also be used to turn pages (page 189).

The following additional settings are available in the TEXT display:

LYRICS	Switches the screen to the Lyrics display.
CLEAR	Clears the text from the screen (the text data itself is not erased). Use this function when you want to clear the text from the display—both the display of the instrument and a connected monitor.
FIXED 16- PROPORTIONAL 28	Determines the text type (fixed or proportional) and font size. Fixed is suitable for displaying lyrics with chord names, since the positions of chord names are “fixed” to the corresponding lyrics. Proportional is suitable for displaying lyrics without chord names or explanatory notes. The numbers 16-28 indicate font sizes.
BACKGROUND	Allows changing of the background picture of the text display, as in the Lyrics display described above. The background setting is common for both the Lyrics display and Text display.

NOTE

- Line feed (or “carriage return”) is not automatically done in the instrument. If a sentence is not displayed in its entirety because of limitations in the screen space, execute the line feed on your computer.
- When the background color is specified in the song data, the BACKGROUND setting cannot be changed.

About Text Data

You can use the following text data in this instrument.

- Simple text files, with the extension .txt.
- Maximum size is 60 KB.
- Line feed and page breaks can be displayed.
- Based on the ISO-8859-1 Latin1 character set.

Displaying the Lyrics/Text on an external monitor

The Tyros2 can be directly connected to an external monitor, letting you display the lyrics and chords of your song data or text which you've created on a large screen. There are two kinds of output connectors—RGB OUT and VIDEO OUT. Connect a computer monitor to the RGB OUT terminal and television or video monitor to the VIDEO OUT jack. The RGB OUT terminal delivers higher resolution than the VIDEO OUT jack.

- ▶ **1** Connect a monitor to the RGB OUT terminal or VIDEO OUT jack of the Tyros2 (page 16).
- ▶ **2** Turn on the monitor and the Tyros2.
- ▶ **3** Set the MONITOR TYPE and SCREEN CONTENT from the [FUNCTION] → SCREEN OUT display (page 188).

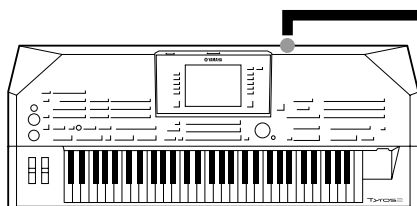

When the SCREEN CONTENT parameter is set to "LYRICS/TEXT," only the lyrics of the song or text are output via RGB OUT/VIDEO OUT, regardless of the display that is called up on the instrument itself. This lets you select other displays and still have the lyrics or text shown on the external monitor.

- ▶ **4** Play the song by following the Basic Procedure (Lyrics/Text) on pages 114 and 115.

Song Position

The Tyros2 provides the following song position features.

- The current song position is indicated on the Main display as measure/beat number during playback—letting you easily see where you are in the song.
- Pressing the [FF] or [REW] button automatically calls up a pop-up window showing the current measure number (or Phrase Mark number) in the display.

For Songs not containing Phrase Marks



Indicates the current measure in song playback.

For Songs containing Phrase Mark



This menu appears only when the song data contains Phrase Marks. You can switch between BAR and PHRASE MARK by pressing the [E] button. When this is set to PHRASE MARK, you can use the [FF] or [REW] buttons to navigate through the Phrase Marks in the song.

- You can put Song Position markers in the song data using the [SP1]–[SP4] buttons (page 44). This not only lets you navigate quickly and easily through a song, but also lets you set up convenient playback loops.

■ Song Position Marker

This section covers two additional Marker-related features and details. For basic information on using the Markers for jump playback and loop playback, refer to page 44 in the Quick Guide.

● Jump Markers

The Markers explained in the Quick Guide on page 44 are also called “Jump Markers.” They can be set in the song data by pressing the [SP1]–[SP4] buttons. In the Event List display of the Song Creator (page 133), they are indicated as “SPJ-01”–“SPJ-04.” In the Event List, they can be moved freely to other positions and can even be copied to create identical Marker numbers at other positions. When the same Marker number is contained at different locations in the song, the latest occurring one is used as an Loop End Marker (below).

● Loop End Marker

Loop End Markers can be used for putting additional Markers in song data, providing even greater versatility. Creating a Loop End Marker is done within the Event List (and not with the [SP1]–[SP4] buttons on the panel), by simply copying one “SPJ” Jump Marker event to another position in the song.

For basic information on loop playback between successive Jump Markers, refer to page 45 in the Quick Guide.

The examples below show how Loop End Markers can be used in song playback.

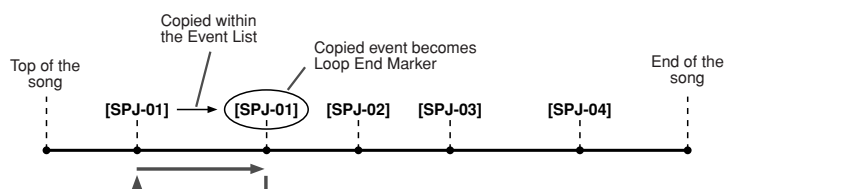

If the song is playing back between the two SPJ-01 points, turning on [LOOP] will result in a playback loop between those points.
If the song is playing back between the second SPJ-01 and SPJ-02 and [LOOP] is turned on, playback jumps back to the first SPJ-01 and loops between two SPJ-01 points.

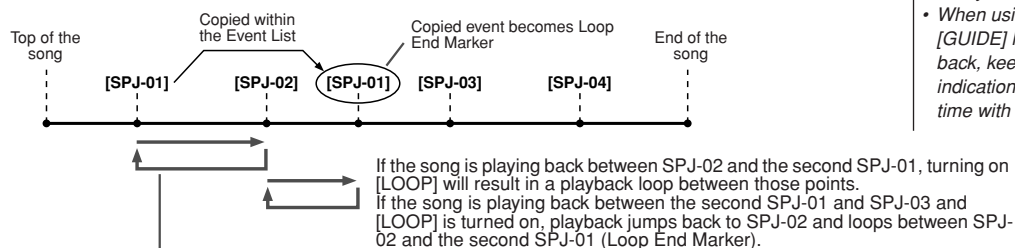

If the song is playing back between SPJ-02 and the second SPJ-01, turning on [LOOP] will result in a playback loop between those points.
If the song is playing back between the second SPJ-01 and SPJ-03 and [LOOP] is turned on, playback jumps back to SPJ-02 and loops between SPJ-02 and the second SPJ-01 (Loop End Marker).

If the [LOOP] button is turned on while the song is playing back between the top of the song and SPJ-02, playback will loop between SPJ-01 and SPJ-02.

In the examples above, the actual data of the Loop End Marker is identical to the event it was copied from—only the location of the copied Marker provides it with this different function.

In song playback, the markers formatted as “SPJ-xxxx” (xxxx: any character except 01–04 and any number of letters is OK) are handled as Loop End Markers. Since the Event List in the Song Creator function does not let you freely name Markers, the instructions above are recommended for creating new Markers. However, with sequence software on a computer, you can create new Markers and assign appropriate names to them. By naming Markers in this way, you can easily distinguish between Loop End Markers and Jump Markers in the Event List.

NOTE

- Loop playback problems may occur if successive Markers are too close to one another.
- When the effect settings of the jump destination (the position you’re jumping to) differ from those at the jump source, glitches or drop-outs in the sound may result. This is because of limitations in the effect processors of the Tyros2.
- When using the Guide function (the [GUIDE] lamp is on) with jump playback, keep in mind that the Guide indication may not be able to stay in time with the jumps.

Song Playback Related Parameters

The Tyros2 has a variety of song playback functions—which can be accessed by pressing [FUNCTION] → SONG SETTING.

- Listen to (or practice along with) your favorite song repeatedly—with Repeat Playback.
- Play back all of the songs in a particular folder—repeatedly or at random—for your listening pleasure.
- Play back all of the songs in all of the folders. Each of the SONG [I]–[VI] buttons has wealth of songs—put them all together and you’ve got a lot of music you can play repeatedly or at random.

If you want, you can interrupt this automatic jukebox at any time and select a song for playback by using the [NEXT/CANCEL] LCD button in the song selection (Open/Save) display. Simply enter the number of the song you want to hear next, and it will be put in the rotation.

Here, the settings on the [FUNCTION] → SONG SETTING display and the Open/Save display for songs are explained together with the points above.

Song Setting—Basic Procedure

1 Press the [FUNCTION] button.

2 Press the [SONG SETTING] LCD button.

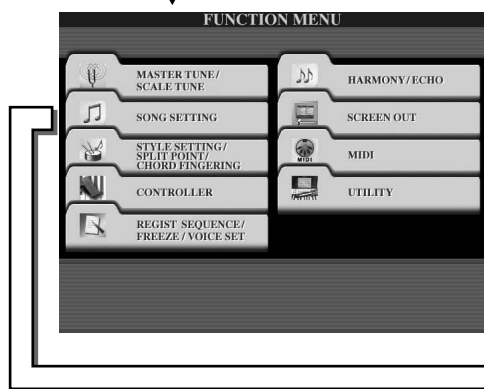

3 Set the desired parameters (next page).

Selects one of the Guide menus (page 49).

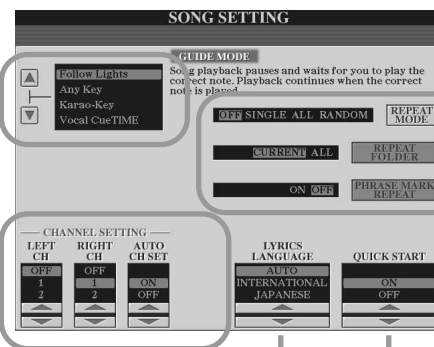

Sets the repeat playback method of the song.

Determines the MIDI channel of each parameter.

Determines the language of the displayed lyrics.

Turns Quick Start on/off.

Next/Cancel—Basic Procedure

1 While a song is playing back, call up the Open/Save display for songs.

2 Press the desired song LCD button so that the NEXT mark appears inside the file box indicating that the selected song has been set to play next. You can cancel this setting by pressing the [NEXT/CANCEL] LCD button and selecting another song.



The following parameters can be set in step #3 in “Basic Procedure” on page 118.

■ Repeat Playback parameters

REPEAT MODE	Determines the method of repeat playback.
	OFF Plays through the selected song, then stops.
	SINGLE Plays through the selected song repeatedly.
	ALL Continues playback through all the songs in the specified folder repeatedly.
REPEAT FOLDER	RANDOM Continues playback at random through all the songs in the specified folder repeatedly.
	Determines the directory in which the songs are played in sequence when the REPEAT MODE is set to “ALL” or “RANDOM.” Here, the directory refers to the path (page 78) memorized to each of the SONG [I]–[VI] buttons.
	CURRENT Sequentially plays all songs in the directory containing the currently selected song, starting with the currently selected song.
REPEAT FOLDER	ALL Sequentially plays all songs in all directories (memorized to the SONG [I]–[VI] buttons). Playback starts with the currently selected song, then the remainder of the songs in the current directory, followed by the songs in the other directories.
	PHRASE MARK REPEAT Phrase Mark is a pre-programmed part of some song data, which specifies a certain location (set of measures) in the song. When this is on, the section corresponding to the specified Phrase Mark number is repeatedly played back (page 117)

■ MIDI Channel parameters

LEFT CH	This parameter is available when the AUTO CH SET below is set to “OFF.” This parameter determines which MIDI channel in the song data is assigned to the Left-hand part of the Guide function and the Song Score function.
RIGHT CH	This parameter is available when the AUTO CH SET below is set to OFF. This parameter determines which MIDI channel in the song data is assigned to the Right-hand part of the Guide function and the Song Score function.
AUTO CH SET	When set to “ON,” this automatically sets the proper MIDI channels for the Right- and Left hand parts preprogrammed in the commercially available song data. Normally, this should be set to “ON.” If this is set to “OFF,” the LEFT CH and RIGHT CH parameters above are available.

■ Lyric Display parameters

LYRICS LANGUAGE	Determines the language of the displayed lyrics.
	AUTO When the language is specified in the song data, the lyrics are displayed accordingly. When the language is not specified in the song data, the lyrics language is regarded as INTERNATIONAL below.
	JAPANESE Handles the displayed lyrics as Japanese.
	INTERNATIONAL Handles the displayed lyrics as a western language.

■ Quick Start parameter

QUICK START	On some commercially available song data, certain settings related to the song (such as voice selection, volume, etc.) are recorded to the first measure, before the actual note data. When Quick Start is set to “ON,” the Tyros2 reads all initial non-note data of the song at the highest possible speed, then automatically slows down to the appropriate tempo at the first note. This allows you to start playback as quickly as possible, with a minimum pause for reading of data.
-------------	---

Playing Backing Parts with the performance assistant Technology

This feature makes it exceptionally easy to play the backing parts along with Song playback.

NOTE

- **Before using performance assistant technology**
To use the performance assistant technology, the Song must contain chord data. If the Song contains this data, the current chord name will be displayed in the Main display during Song playback, letting you easily check whether the Song contains chord data or not.

▶ **1** Select a Song (page 43).

▶ **2** Press the [P. A. T.] button to turn the feature on.

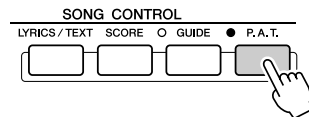

▶ **3** Press the SONG CONTROL [PLAY/PAUSE] button to start playback.

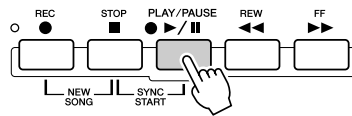

▶ **4** Play the keyboard.

The instrument automatically matches your performance on the keyboard to the Song playback and chords, no matter what keys you play. It even changes the sound according to the way you play. Try playing in the three different ways below.

- Playing the left and right hand together (method 1).

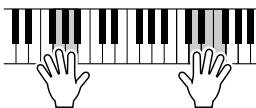

Play three notes at the same time with your right hand.

- Playing the left and right hand together (method 2).

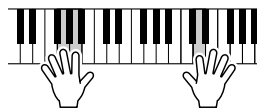

Play several notes one after the other with different fingers of your right hand.

- Playing the left hand and right hand alternately.

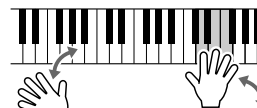

Play three notes at the same time with your right hand.

▶ **5** Press the SONG CONTROL [STOP] button to stop playback.

▶ **6** Press the [P. A. T.] button again to turn the feature off.

Song Creator (Digital Recording)

Quick Guide on pages 55–58 →

This section explains operations not covered in the Quick Guide, including Step Recording and re-recording or editing existing song data. For basic information on recording a song using Quick Recording and Multi Recording, refer to the Quick Guide.

Realtime Recording and Step Recording

You can record your keyboard performance as MIDI data in two different ways: Realtime and Step.

- **Realtime Recording** This method records performance data in real time, overwriting any data already present in the destination channel. The new data replaces the previous data. This method is covered in the “Quick Guide.”
- **Step Recording** This method lets you compose your performance by “writing” it down one event at a time. This is a non-realtime, manual recording method—similar to writing music notation onto paper. By using the Event List (pages 125, 127, 133), you can input notes, chords and other events one by one.

Punch In/Out

Page 122

This Realtime recording method lets you re-record only over a specific area of the already-recorded song.

Data between the Punch In point and the Punch Out point is overwritten with the material recorded. Keep in mind that the parts before and after the Punch In/Out section are not recorded over—they play back normally to guide you in and out of the recording.

You can specify the Punch In and Punch Out points as measure numbers beforehand for automatic operation, or manually execute the Punch In/Out recording by using a Foot Pedal or simply by playing the keyboard.

Set the Punch In/Out related parameters on the [DIGITAL RECORDING] → SONG CREATOR → REC MODE display and re-record the already-recorded song by following the instructions described in the “Quick Guide.”

Step Recording using the Event List



Pages 125, 127, 133

Song data is made up of various recorded MIDI events, including global events for the entire song and specific events for each channel. The MIDI Event List is a useful Song Creator tool that arranges all events in a song in chronological order (in measures, beats, clocks), and allows you to make detailed changes to those events. Among the events included are:

- Chord/SectionThese style playback events let you enter Chords and Sections (Intro, Main, Ending, and so on).
- MIDI channel (1–16) data.....Channel-specific events, such as note on/off, program change (voice number), control change messages (including volume and pan of the Mixing Console settings), and pitch bend
- System Exclusive Messages.....Events that affect all channels, such as tempo and beat (time signature)
- Lyrics.....Song Lyric data

Remember that you can also use Realtime Recording to re-record a song that has already been created with Step Recording.

Basic Procedure (Song Creator)

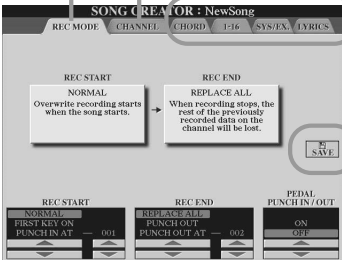
- 1** Select an already-recorded song or a new song (page 55).
- 2** Press the [DIGITAL RECORDING] button.
 
- 3** Press the [SONG CREATOR] LCD button.
 
- 4** This page lets you edit the already-recorded song data by converting for each channel.
 

NOTE

- From the Song Creator display you can fast-forward or rewind through the song as desired—letting you quickly navigate to and check different sections of the song.

Determines the Punch In/Out settings on this page if you wish to re-record the already-recorded song.

Re-record the song by following the instructions (from step #2 to end) in the Quick Guide.

These pages let you create the song data by using the MIDI event list.

CAUTION

After completing the song creation, make sure to execute the Save operation. The recorded song will be lost if you change to another song or you turn the power off without executing the save operation.

The operations corresponding to step #4 are covered in the following page.

Record Mode Settings (Setting up for Re-recording)

The following parameters can be set when you call up the REC MODE page in step #4 of the Basic Procedure. Set the parameters below and press the [REC] button to re-record an existing song by following the instructions (from step #2 to end) in the “Quick Guide.”

■ REC START settings.....

NORMAL	Pressing the SONG CONTROL [PLAY/PAUSE] button or playing the keyboard with [SYNC START] on starts overwrite recording.
FIRST KEY ON	The song plays back normally, then starts overwrite recording as soon as you play the keyboard.
PUNCH IN AT	The song plays back normally up to the indicated Punch In measure, then starts overwrite recording at the specified Punch In measure (set with the corresponding LCD button).

■ REC END settings.....

REPLACE ALL	This deletes all data following the point at which recording is stopped.
PUNCH OUT	The song position at which recording is stopped is regarded as the Punch Out point. This setting maintains all data following the point at which recording is stopped.
PUNCH OUT AT	Actual overwrite recording continues until the specified Punch Out measure (set with the corresponding LCD button), at which point recording stops and normal playback continues.

■ PEDAL PUNCH IN/OUT settings

When this is set to ON, you can use Foot Pedal 2 to control the punch-in and punch-out points. While a song is playing back, pressing (and holding) Foot Pedal 2 instantly enables Punch In recording, while releasing the pedal stops recording (Punch Out). You can press and release Foot Pedal 2 as often as you want during playback to punch in/out of overwrite recording. Note that the current function assignment of the sostenuto pedal is cancelled when the Pedal Punch In/ Out function is set to ON.

Examples for re-recording depending on the REC MODE settings

The Tyros2 features several different ways you can re-record or replace a specific section of an already recorded channel. The illustrations below indicate a variety of situations in which selected measures in an eight-measure phrase are re-recorded.

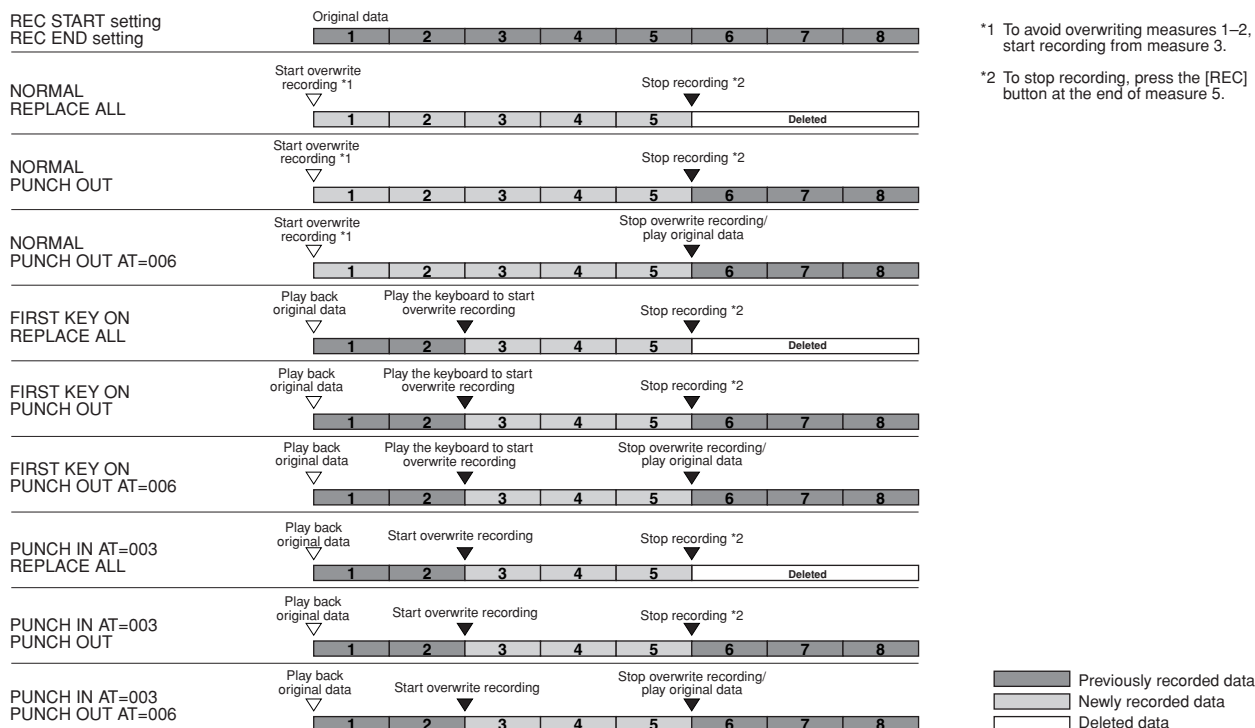

Editing Data for each Channel

To set the following parameters, call up the CHANNEL page in step #4 of the Basic Procedure on page 121.

1 Select a menu.

3 Executes the operation for the displayed page. After the operation (with the exception of the SETUP page) is completed, this button changes to [UNDO], letting you restore the original data if you are not satisfied with the Operation results. The Undo function only has one level; only the previous operation can be undone.

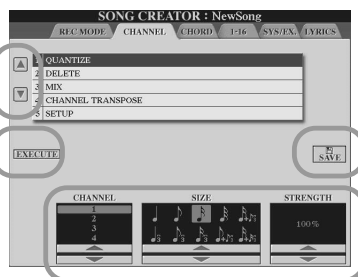

2 Set the parameters as desired.

4 **CAUTION**

After you've finished creating/editing a song, make sure to execute the Save operation. The recorded song will be lost if you change to another song or you turn the power off without executing the save operation.

■ Quantize (set in step #2 above)

Quantize lets you “clean up” or “tighten” the timing of a previously recorded track. For example, the following musical passage has been written with exact quarter-note and eighth-note values.



When actually recording the passage in real time, however, you may not play it with perfect accuracy. Quantize allows you to align all the notes so that the timing is absolutely accurate to the specified note value.

CHANNEL	Determines which MIDI channel in the song data is to be quantized.
SIZE	<p>Selects the quantize size (resolution). Set the Quantize size to correspond to the shortest note value in the channel you are working with. For example, if the data was recorded with both quarter notes and eighth notes, use 1/8 note for the Quantize size. If you apply a 1/4 note Quantize size, the eighth notes would be moved on top of the quarter notes.</p> <p>One measure of eighth notes before quantization After 1/8 note quantization</p> <p>Settings:</p> <p> 1/4 note 1/8 note 1/16 note 1/32 note 1/16 note+ 1/8 note triplet* 1/4 note triplet 1/8 note triplet 1/16 note triplet 1/8 note+ 1/8 note triplet* 1/16 note+ 1/16 note triplet* </p> <p>The three Quantize settings marked with asterisks (*) are exceptionally convenient, since they allow you to quantize two different note values at the same time, without compromising the quantization of either one. For example, if you have both straight 1/8 notes and 1/8 note triplets recorded to the same channel, and you quantize to straight 1/8 notes, all notes in the channel are quantized to straight 1/8 notes—completely eliminating any triplet feel in the rhythm. However, if you use the 1/8 note + 1/8 note triplet setting, both the straight and triplet notes will be quantized correctly.</p>
STRENGTH	<p>Determines how strongly the notes will be quantized. If a value less than 100% is selected, notes will be moved toward the specified quantization beats only by the specified amount. Applying less than 100% quantization lets you preserve some of the “human” feel in the recording.</p> <p>Quarter-note length</p> <p>Original data (assuming 4/4 meter)</p> <p>Quantizing strength =100</p> <p>Quantizing strength =50</p>

■ Delete

This lets you delete recorded data of the specified channel in the song data. Select the channel to be deleted by using the upper/lower LCD [1]–[8] buttons and press the [EXECUTE] LCD button.

■ **Mix (set in step #2 on the previous page)**.....

This function lets you mix the data of two channels and place the results in a different channel. It also lets you copy the data from one channel to another.

SOURCE1	Determines the MIDI channel (1–16) to be mixed. All MIDI events of the channel specified here are copied to the destination channel.
SOURCE2	Determines the MIDI channel (1–16) to be mixed. Only note events of the channel specified here are copied to the destination channel. Besides the values 1–16, there is a “COPY” setting that allows you to copy the data from Source 1 to the destination channel.
DESTINATION	Determines the channel into which the mix or copy results will be placed.

■ **Channel Transpose**

This allows you to transpose the recorded data of individual channels up or down by a maximum of two octaves in semitone increments.

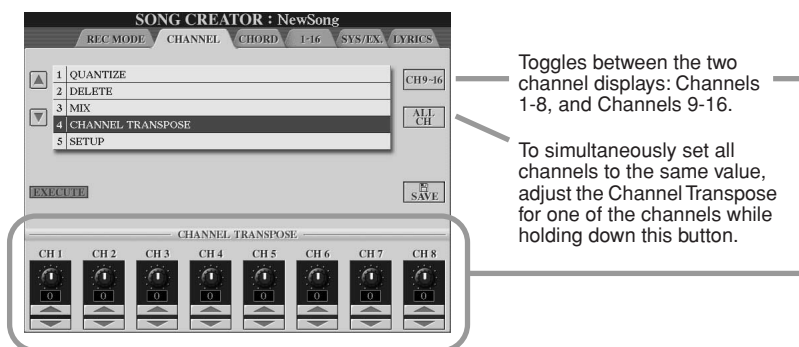

■ **Setup (set in step #2 on the previous page)**.....

The current settings of the Mixing Console (page 179) display and panel button settings can be recorded to the top position of the song as Setup data. The panel settings recorded here are automatically recalled as soon as the song starts.

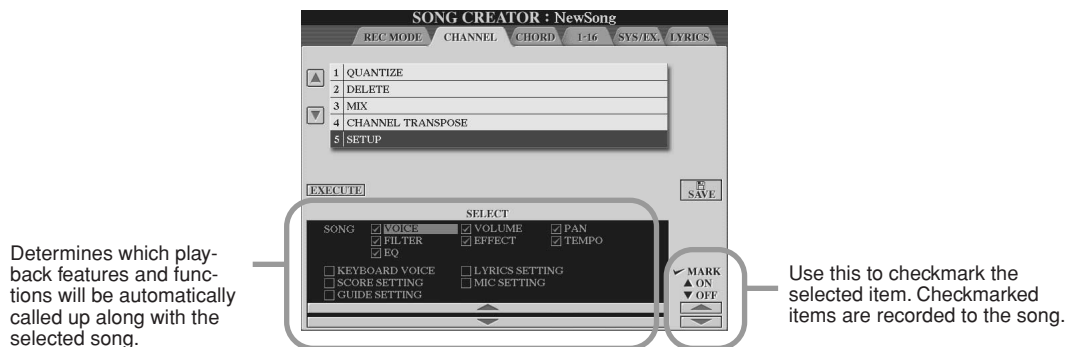

Determines which playback features and functions will be automatically called up along with the selected song.

SONG	Records the tempo setting and all settings made from the Mixing Console.
KEYBOARD VOICE	Records the current panel settings, including the voice of the keyboard-played parts (RIGHT 1, 2, 3, and LEFT) and their on/off status. Panel settings recorded here are same as the ones memorized to the One Touch Setting (page 155). Unlike the other items in this chart, this can be recorded at any point in a song.
SCORE SETTING	Records the settings of the Score display.
GUIDE SETTING	Records the settings of the Guide functions. When the settings are recorded, selecting a song automatically turns on the Guide functions.
LYRICS SETTING	Records the settings of the Lyrics display.
MIC SETTING	Stores the microphone settings in the Mixing Console (page 179) display and the Vocal Harmony settings.

Step Recording for Chord data using the Event List

The explanations here apply when you call up the CHORD page in step #4 of the Basic Procedure on page 121. This feature makes it possible to record Style playback chord changes one at a time with precise timing. Since the changes don't have to be entered in real time, it is easy to create complex chord changes and accompaniment—even before recording the melody.

Use the CHORD display if you wish to edit the already-recorded Chord events one by one.

Use the STEP RECORD display if you wish to enter the Chord events from scratch.

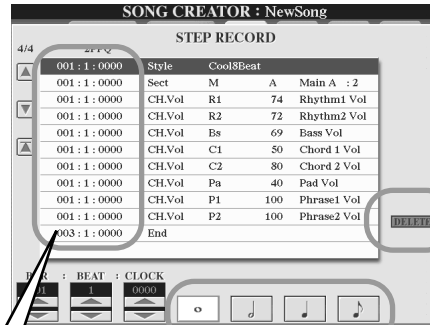
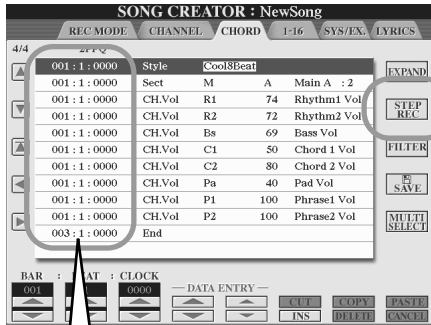

Press this to actually delete the event at the current cursor position.

The song position at which you edit or input the event is indicated by the following three values.

001 : 1 : 0000

Measure number (BAR) Beat Clock (1920 clocks per 1/4-note)

This sets the "size" of the next Chord/Section event to be entered in step recording, and determines to what position the pointer will advance after the event has been entered.

■ Entering Chord/Section events from scratch.....

For example, the following chord progression can be entered by the procedure described below.

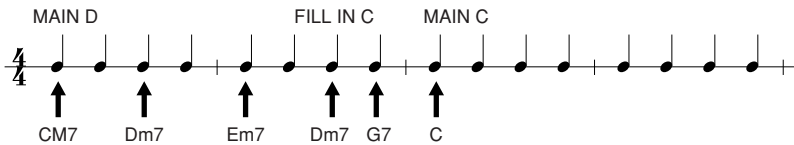

▶ **1** Press the [MAIN D] button to specify the section and enter the chords as shown at right.

Sect:
Indicates the Section change event.

Chord:
Indicates the Chord change event.

Select this resolution and play chords as shown at right.

NOTE
• Make sure to turn [AUTO FILL IN] off.

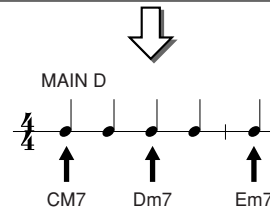

- ▶ **2** Press the [AUTO FILL IN] button and press the [MAIN C] button to specify the section (Fill In C) then enter the chords as shown at right.

Time	Style	Tempo	OnOff	R1	On	Chord
001 : 1 : 0000	Cool8Beat	100	00000000			M7
001 : 1 : 0000						D
001 : 1 : 0000						Main D : 2
001 : 1 : 0000						C
001 : 3 : 0000						D
001 : 3 : 0000						m7
002 : 1 : 0000						E
002 : 1 : 0000						m7
002 : 3 : 0000						F
002 : 3 : 0000						C
002 : 3 : 0000						Fill In C : 1
004 : 1 : 0000						End

Select this resolution and play chords as shown at right.

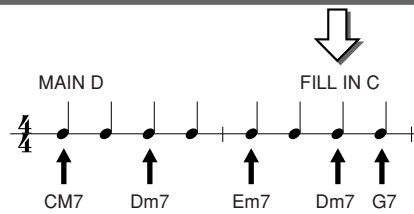

- ▶ **3** Enter the chords as shown at right.

Time	Style	Tempo	OnOff	R1	On	Chord
001 : 1 : 0000	Cool8Beat	100	00000000			M7
001 : 1 : 0000						D
001 : 1 : 0000						Main D : 2
001 : 1 : 0000						C
001 : 3 : 0000						D
001 : 3 : 0000						m7
002 : 1 : 0000						E
002 : 1 : 0000						m7
002 : 3 : 0000						F
002 : 3 : 0000						C
002 : 3 : 0000						Fill In C : 1
002 : 3 : 0000						G
002 : 3 : 0000						7
004 : 1 : 0000						End

Select this resolution and play chords as shown at right.

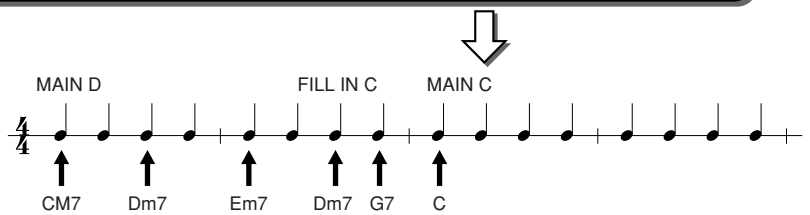

- ▶ **4** Move the song position to the top and play the song to hear the newly recorded chord progression.

You can also move the song position to the top of the song by using this LCD button.

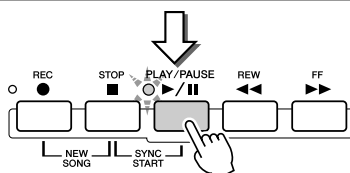

IMPORTANT

- The chord progression can be played back only from this STEP RECORD display. To play the chords, you'll need to press the [EXPAND] LCD button (next page) on the CHORD display to convert the events recorded here to song data.

■ Editing existing Chord events

The Chord events already entered to the STEP RECORD display can be edited from the CHORD display.

With the exception of the Expand function explained below, the operations for the CHORD display are the same as that of the channel data editing display (1-16 page) described on page 132.

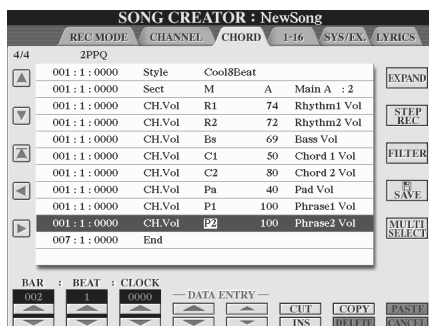

Press this to convert the recorded chord and section entries into song data. You'll need to execute the Expand operation to properly play back the data you entered in the STEP RECORD page (described on the previous page).

NOTE

• Chord and Section data recorded with Realtime Recording cannot be indicated and edited on this display.

Events handled on the Chord Event list display (CHORD page)

- Style
- Tempo
- Chord—Chord root, Chord type, On Bass Chord
- Sect—Style Section (Intro, Main, Fill In, Break, Ending)
- OnOff—On/off status for each part (channel) of the style
- CH.Vol—Volume for each part (channel) of the style
- S.Vol—Overall volume of the style

Step Recording for Notes using the Event List

The explanations here apply when you call up the “1-16” page in step #4 of the Basic Procedure on page 121.

This page lets you create a song by entering notes one by one for each channel with precise timing, without having to perform them in real time. The Tyros2 lets you record the chords for style playback and the melody (explained here) separately.

Use the 1-16 display if you wish to edit the already-recorded Note events one by one for each channel.

Use the STEP RECORD display if you wish to enter the Note events from scratch.

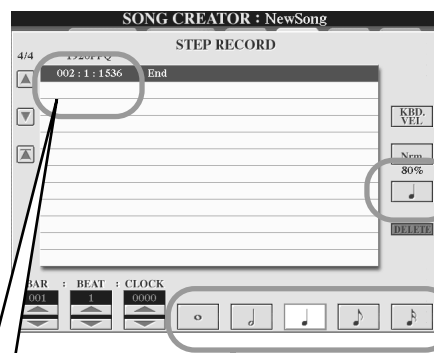
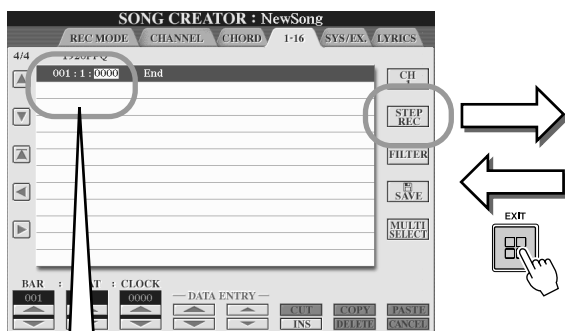

Pressing the button alternately switches the note selectors (at the bottom of the display) among three basic note values: normal, dotted and triplet.

The song position at which you edit or input the event is indicated by the following three values.

001 : 1 : 1440
 Measure number (BAR) | Beat | Clock (1920 clocks per 1/4-note)

This sets the “size” of the next note event to be entered, and determines to what position the pointer will advance after it has been entered.

NOTE

• To input rests, simply specify the position for the next note (using the [BAR], [BEAT], and [CLOCK] LCD buttons) and input the note. Any “empty” interval between two successive notes is automatically registered as a rest.

■ Entering note events from scratch.....

This section explains how to step-record notes, using three specific examples.

Example 1



NOTE

• Since the music score displayed on the instrument is generated from the recorded MIDI data, it may not appear exactly the same as shown here.

▶ 1 Set the parameters below in sequence.

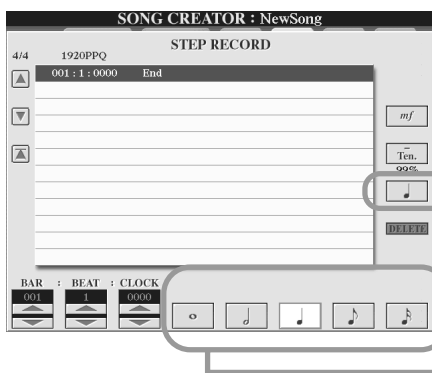





Use these buttons to set the "size" or "resolution" of the current recording step time for the next note to be entered. Here, we'll set the resolution to a 1/4 note, as specified in the example.

Determines the velocity (loudness) of the note to be entered. Here, we'll select "mf," as specified in the example.

Value	Actual recorded velocity
Kbd.Vel	Actual playing strength
fff	127
ff	111
f	95
mf	79
mp	63
p	47
pp	31
ppp	15

Sets the Gate Time, or the length of the note (as a percentage). Here, we'll select "Tenuto," as specified in the example.

Value	Actual recorded velocity
Normal	 80%
Tenuto	 99%
Staccato	 40%
Staccatissimo	 20%
Manual	The gate time (note length) can be set to any desired percentage by using the [DATA ENTRY] dial.

▶ 2 Play the keys C, D, E, F, G, A, B and C in order, as specified in the example.

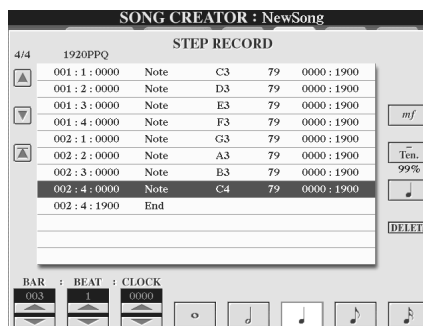
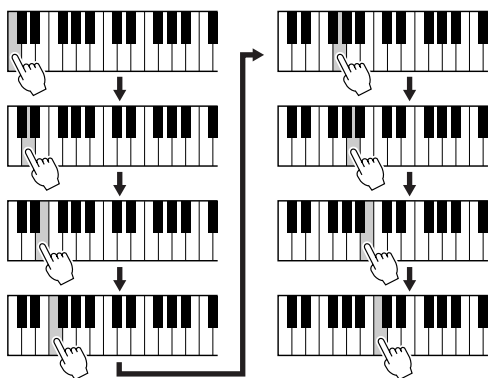

▶ 3 Move the cursor to the beginning of the song by pressing the [STOP] button, and press the SONG CONTROL [PLAY/PAUSE] button to hear the newly entered notes.

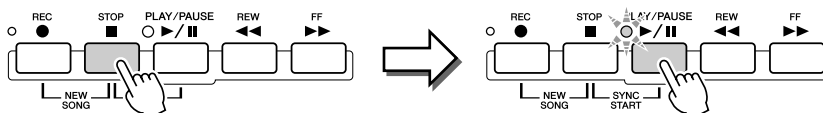

▶ 4 Press the [EXIT] button to exit from the Step Recording display.

▶ 5 Press the [SAVE] LCD button ([I] button) to call up the Song Open/Save display for saving your data, then save the data in the Open/Save display (page 75).

CAUTION

• The recorded data will be lost if you select another file or turn the power to the instrument off without executing the Save operation.

Example 2

**NOTE**

- Since the music score displayed on the instrument is generated from the recorded MIDI data, it may not appear exactly the same as shown here.

In this example, keep in mind that one of the steps involves holding down a key on the keyboard while executing the operation.

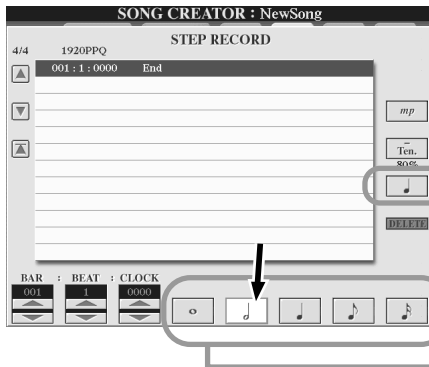
▶ **1** Set the parameters below in sequence.

Determines the velocity (loudness) of the note to be entered. Here, we'll select "**mp**," as specified in the example.

Sets the Gate Time, or the length of the note (as a percentage). Here, we'll select "**Ten.**" as specified in the example.

Use these buttons to set the resolution of the next note(s). Here, we'll set the resolution to a **half note**, as specified in the example.

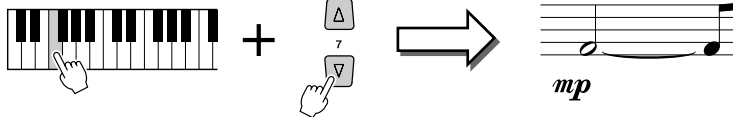
▶ **2** Enter the note F, as specified in the example.

While holding F on the keyboard, press the 1/8 note LCD button. This enters a half note (for "F") and a tied 8th note.

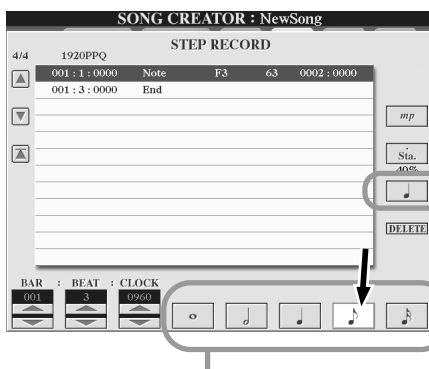
▶ **3** Set the parameters below in sequence.

Sets the Gate Time, or the length of the note (as a percentage). Here, we'll select "**Staccato**," as specified in the example.

Use these buttons to set the resolution of the next notes. Here, we'll set the resolution to an **1/8 note**, as specified in the example.

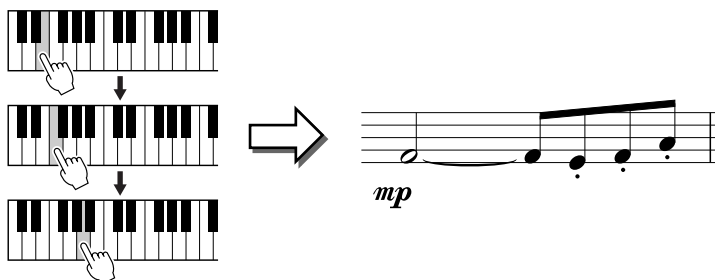
▶ **4** Play the keys E, F and A, as specified in the example.

▶ **5** Set the parameters below in sequence.

Determines the velocity (loudness) of the note to be entered. Here, we'll select "f," as specified in the example.

Sets the Gate Time, or the length of the note (as a percentage). Here, we'll select "Ten." as specified in the example.

Use these buttons to set the resolution of the next note. Here, we'll set the resolution to a **dotted half note**, as specified in the example.

▶ **6** Play an A on the keyboard, as specified in the example.



▶ **7** Set the parameters below in sequence.

Use these buttons to set the resolution of the next note. Here, we'll set the resolution to a **1/4 note**, as specified in the example.

▶ **8** Play an F on the keyboard, as specified in the example.



▶ **9** Move the cursor to the beginning of the song by pressing the [STOP] button, and press the SONG CONTROL [PLAY/PAUSE] button to hear the newly entered notes.

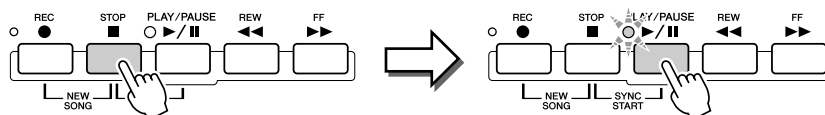

▶ **10** Press the [EXIT] button to exit from the Step Recording display.

▶ **11** Press the [SAVE] LCD button ([I] button) to call up the Song Open/Save display for saving your data, then save the data in the Open/Save display (page 75).

CAUTION

• The recorded data will be lost if you select another file or turn the power to the instrument off without executing the Save operation.

Example 3



NOTE

- Since the music score displayed on the instrument is generated from the recorded MIDI data, it may not appear exactly the same as shown here.

To properly enter the tied notes here, keep in mind that you'll need to hold the keys down during the entire operation until all the notes are entered.

▶ **1** Set the parameters below in sequence.

Determines the velocity (loudness) of the note to be entered. Here, we'll select "ff," as specified in the example.

Sets the Gate Time, or the length of the note (as a percentage). Here, we'll select "Normal," as specified in the example.

Use these buttons to set the resolution of the next note. Here, we'll set the resolution to an 1/8 note, as specified in the example.

▶ **2** Enter the note C3, as specified in the example.

Do not release C3 yet. Keep holding the note as you execute the following steps.

While holding the key C3, press the 1/8 note LCD button.

▶ **3** Enter the note E3.

Do not release C3 and E3 yet. Keep holding the notes as you execute the following steps.

While holding the keys C3 and E3, press the 1/8 note LCD button.

▶ **4** Enter the note G3.

Do not release C3, E3 and G3 yet. Keep holding the notes as you execute the following steps.

While holding the keys C3, E3 and G3, press the 1/8 note LCD button.

▶ **5** Enter the note C4.

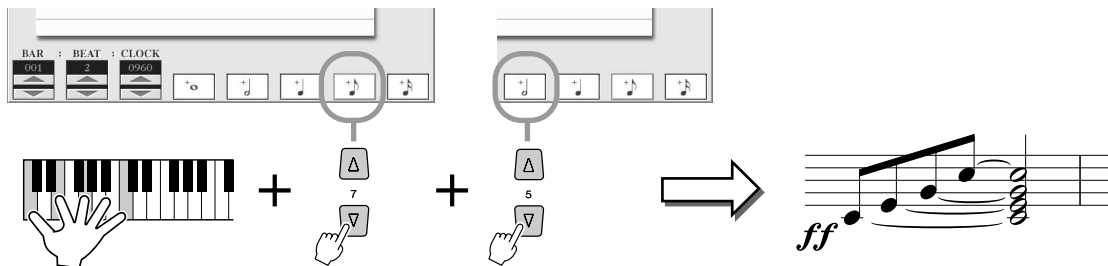

While holding the keys C3, E3, G3 and C4, press the 1/8 note LCD button, then press the half note LCD button. All notes in the example have now been entered and you can release the keys.

▶ **6** Move the cursor to the beginning of the song by pressing the [STOP] button, and press the SONG CONTROL [PLAY/PAUSE] button to hear the newly entered notes.

▶ **7** Press the [EXIT] button to exit from the Step Recording display.

▶ **8** Press the [SAVE] LCD button ([I] button) to call up the Song Open/Save display for saving your data, then save the data in the Open/Save display (page 75).

CAUTION

The recorded data will be lost if you select another file or turn the power to the instrument off without executing the Save operation.

■ **Editing existing Note events on the STEP RECORD display**

Note events and other various channel events already entered to the STEP RECORD display can be edited from the 1-16 display. The explanations below also apply to other Event List displays (CHORD, SYS/EX., LYRICS).

TIME	EVENT	CHANNEL	VALUE	START	END
001:1:0000	Note	C3	70	0000:1536	
001:2:0000	Note	D3	61	0000:1536	
001:3:0000	Note	E3	76	0000:1536	
001:4:0000	Note	F3	72	0000:1536	
002:1:0000	Note	G3	78	0000:1536	
002:2:0000	Note	A3	81	0000:1536	
002:3:0000	Note	B3	77	0000:1536	
002:4:0000	Note	C4	88	0000:1536	
002:4:1536	End				

Use these to move the song position (cursor) up/down and select the desired event.

Moves the song position (cursor) to the beginning position of the data.

Use these to move the cursor left/right and select the desired parameter of the highlighted event.

Determines the current position of the data.

For coarse adjustment of the event value. Keep in mind that moving the cursor away from the just edited value or starting the song playback automatically enters that value.

For fine adjustment of the event value. You can use the [DATA ENTRY] dial to adjust the value. Keep in mind that moving the cursor away from the just edited value or starting the song playback automatically enters that value.

Determines the channel for the MIDI event edited here or entered to the STEP RECORD display.

Calls up the Filter display (page 134), letting you select only the events you wish to be shown in the Event List.

Holding this button down while using the [A] and [B] buttons lets you select multiple events. This convenient feature lets you select several events together, making it possible to change the values of many different events at once, or easily and quickly copy many events to another location.

If the value at the cursor has been changed, pressing this restores the original value.

CUT, COPY, PASTE and DELETE are the same functions as those in the Open/Save display, except that these apply to MIDI events, not files.

Adds a new event to the Event List.

Events handled on the Note Event list display (1-16 page)

Note (Note on/off)	Messages which are generated when the keyboard is played. Each message includes a specific note number which corresponds to the key which is pressed, plus a velocity value based on how hard the key is played.
Ctrl (Control Change)	Controller settings such as volume, pan (edited via the Mixing Console described on page 179), etc.
Prog (Program Change)	Determines the voice (program) number. For details on program change messages and how to set them, refer to the separate Data List booklet (Voice List).
P.Bnd (Pitch Bend)	Events generated by controlling the PITCH BEND wheel. These events bend the pitch of notes up or down.
A.T. (Aftertouch)	Determines the aftertouch value.

For details on the events above, refer to the separate Data List booklet (MIDI Data Format).

Step Recording for System Exclusive Messages using the Event List

The explanations here apply when you call up the SYS/EX. page in step #4 of the Basic Procedure on page 121. From this display, you can edit recorded System events which do not belong to a specific MIDI channel, such as tempo and beat (time signature). The instructions for this display are basically the same as those for the channel data editing display (1-16 page) described on page 105.

Events handled on the System Exclusive (SYS/EX.) Event list display

ScBar (Score initial measure)	This determines the number of the top measure. You cannot move the song position to the measure before the one set here. When the song is selected, the measure (bar) number set here is indicated on the Main display. Pressing the [STOP] button moves the song position to the measure (bar) number set here.
Tempo	Determines the tempo value.
Time (Time signature)	Determines the time signature.
Key (Key signature)	Determines the key, as well as the major/minor setting. This setting is used for displaying the notation (Song Score function).
XG Prm (XG parameters)	Allows you to make various detailed changes to the data. For more information on XG parameters, refer to the separate Data List booklet (MIDI Data Format).
SYS/EX. (System Exclusive)	Displays the System Exclusive data in the song. Keep in mind that you cannot create new data or change the contents of the data here; however, you can delete, cut, copy, and paste the data.
Meta (Meta event)	Displays the SMF meta events in the song. Keep in mind that you cannot create new data or change the contents of the data here; however, you can delete, cut, copy, and paste the data.
Marker (Song Position Marker)	Displays the Song Position Marker (SPJ-01-04) in the song. Keep in mind that you cannot create new data or change the contents of the data here; however, you can delete, cut, copy, and paste the data.
HDR (HDR play control)	This controls Audio song playback via song data. This event is used to playback a MIDI song and Audio song in succession; the Audio song cannot be synchronized to the MIDI song playback.

Step Recording for Lyrics using the Event List

The explanations here apply when you call up the LYRICS page in step #4 of the Basic Procedure on page 121. From this display, you can edit recorded Lyrics events. The instructions for this display are basically the same as those for the channel data editing display (1-16 page) described on page 132.

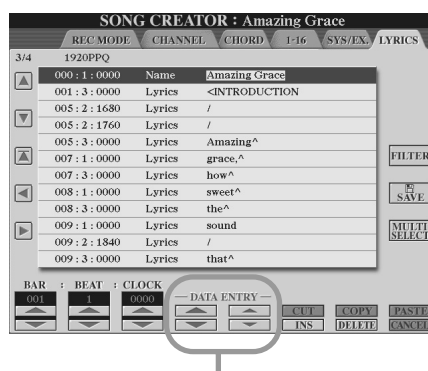

Pressing one of these buttons from the Lyrics display calls up the pop-up window for entering lyrics to the currently selected position. Entering lyrics is done in the same way as naming files, as described on page 76.

Events handled on the Lyrics Event list display

Name (Song name)	Determines the song name. This calls up the pop-up window for entering a name.
Lyrics	Allows you to enter lyrics.
Code (Other controls)	CR : Enters a line break in the lyrics text. LF : Deletes the currently displayed lyrics and display the next set of lyrics.

Customizing the Event List—Filter

Because the Event List displays (CHORD, 1-16, SYS/EX. and LYRICS) contain a wide variety of events, it may be difficult to pinpoint the ones you want to edit. This is where the Filter function comes in handy. It lets you determine which event types will be shown in the Event List displays. To call up the Filter display below, press the [FILTER] LCD button from any of the Event List displays.

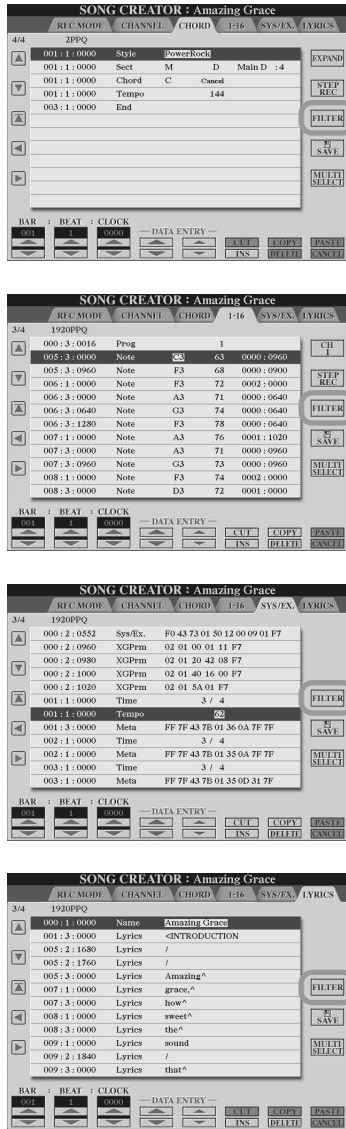

Select the desired Filter category from the three below, then checkmark the items you want to be shown in the Event List displays.

- MAIN** : Displays all main types of events.
- CTRL CHG** : Displays all specific Control Change message events.
- STYLE** : Displays all types of style playback related events.

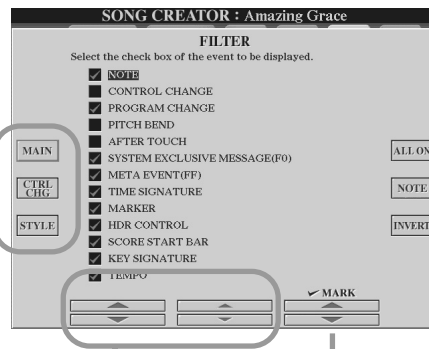

Recording Audio with the Hard Disk Recorder

Quick Guide on page 59 ➔

This section explains operations not covered in the Quick Guide, including overdubbing additional audio to an existing file, using the Punch In/Out recording features, using the Playlist mode for automatic playback of multiple files, and importing audio data from a computer or external storage device. For basic information on recording audio using the Hard Disk Recorder, see page 59 in the Quick Guide.

NOTE

- Audio files can be exported (for editing and storage purposes) and then imported back to the Hard Disk Recorder; however, they cannot be edited directly on the Tyros2.
- The "Basic/Playlist" indicator at the upper left of the display shows whether the Hard Disk Recorder is set to the Basic mode (playback of a single file or recording your performance) or the Playlist mode (automatic playback of multiple files). This lets you keep the Playlist active in the background, ready to play the listed files when you want. (For details on the Playlist mode, see page 147.)

Hard Disk File/Folder Operations—Open/Save Display

The file and folder operations in the Hard Disk Recorder from the HARD DISK RECORDER [SELECT] button are performed in the Open/Save display, in much the same way as other file/folder operations on the Tyros2. Most of these operations allow you to organize your recorded data. However, other operations in these menus, such as Wave Import, Export and Playlist, pertain specifically to the Hard Disk Recorder. For general information and more details on Open/Save displays, see page 72.

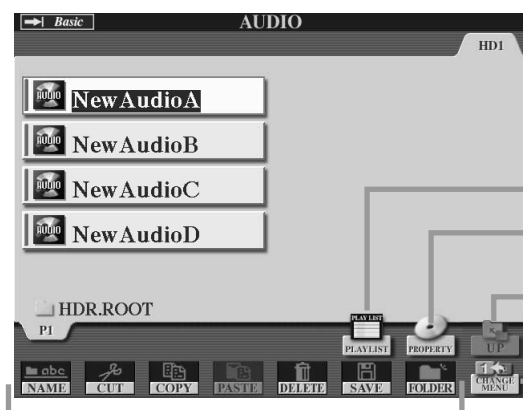

See pages 73–76.

Calls up the current Playlist and the Playlist operations. (Page 147)

Calls up the Property popup display of the currently selected audio file. (Page 136)

This selects the next highest folder in the hard disk drive. (The indication is "ghosted" if the root directory is selected and no higher folder exists.)

This switches to the second Open/Save menu display (see below).

NOTE

- A file that is currently loaded cannot be deleted. If you want to delete the loaded file, load another file first, then select the desired file to be deleted.

NOTE

- If you cannot copy a folder, the reason may be that the folder contains too many files. If this is the case, select all files by using "ALL" in the copy pop-up window and copy the files.

NOTE

- Audio files seem to be "files" in the AUDIO Open/Save display, but actually they are folders which contain audio file and some other data. You can see the audio files as folders on your computer.

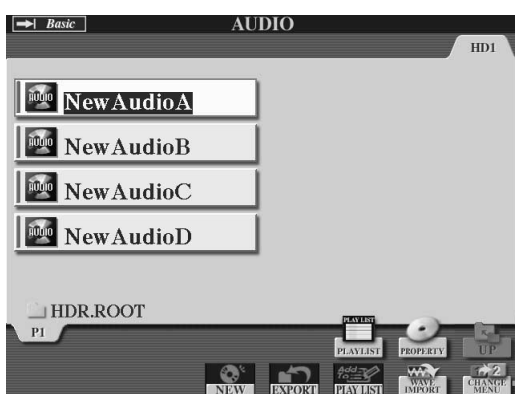

This switches to the first Open/Save menu display (see above).

Calls up the Wave Import operation. (Page 137)

For adding audio files to the Playlist. (Page 147)

For exporting an audio file to a hard disk drive or USB storage device. (Page 139)

For creating a new audio file. (Page 60)

Property display

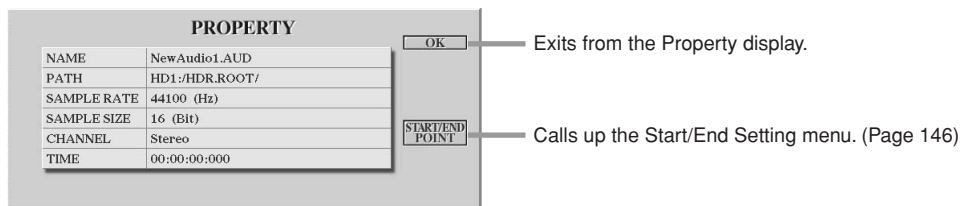

Property parameters

NAME	Indicates the full name of the audio file, including the extension.
PATH	Indicates the location and path of the file.
SAMPLE RATE	Indicates the sample rate of the recorded audio.
SAMPLE SIZE	Indicates the bit size or resolution of the recorded audio.
CHANNEL	Indicates the configuration of the audio.
TIME	Indicates the time between Start and End points of the audio, in hours/minutes/seconds/milliseconds.

Importing an Audio File

In addition to letting you record audio directly with the Tyros2, the Hard Disk Recorder also allows you to import audio data from a USB storage device. The benefits of this feature are many. For example, you can:

- Use existing audio material (commercially available samples, loops, sound effects, etc.) on the Tyros2.
- Record your performance to another device (such as on a computer or audio sequencer), add vocals and other instruments as desired, then import the finished audio to the Tyros2.
- Export a recording made on the Tyros2 to a computer-based audio editor—giving you more comprehensive editing features and greater editing convenience—then import the audio back to the Tyros2. (See “Exporting an Audio File” on page 139.)

Files which can be imported must have these characteristics:

- Stereo Wave data
- 44.1 kHz sample rate
- 16-bit resolution
- A length of less than or equal to 80 minutes

▶ 1 Insert the USB device (or connecting cable) to the USB TO DEVICE terminal.

For purposes of illustration, we'll use a USB flash drive here.

▶ 2 Press the HARD DISK RECORDER [SELECT] button to call up the AUDIO display.

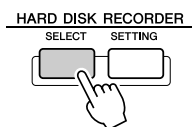

▶ 3 Press the [CHANGE MENU] LCD button (lower [8] button) if necessary, then call up the Import function by pressing the [WAVE IMPORT] LCD button (lower [7] button).

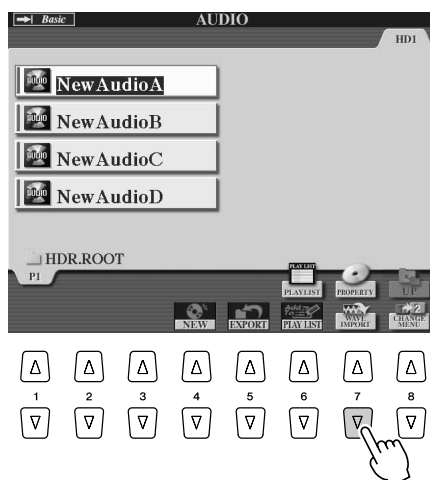

▶ 4 Select the desired device by using the [TAB] buttons.

Generally, a USB device will show up as “USB1” in the display. When the device is selected, all folders and audio files on the device are automatically shown.

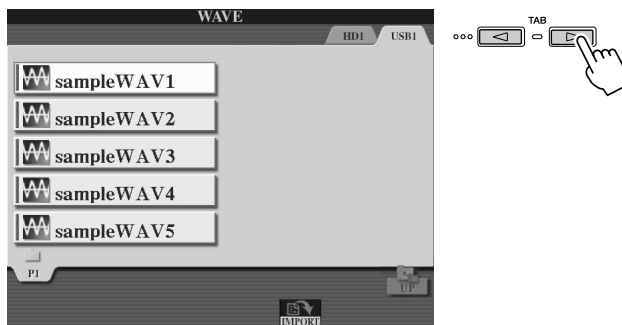

▶ 5 Press the [IMPORT] button (lower [6] button).

Alternately, if you desire to import only one file, you can import it by double clicking the appropriate [A]–[J] button.

▶ 6 Select the desired audio file by using the [A]–[J] buttons.

The selected file name is highlighted. You can continue to select additional files here, as many as desired. If multiple pages (tabs) are shown at the bottom, you can select files from these displays, too. After that, press the [OK] LCD button (lower [7] button).

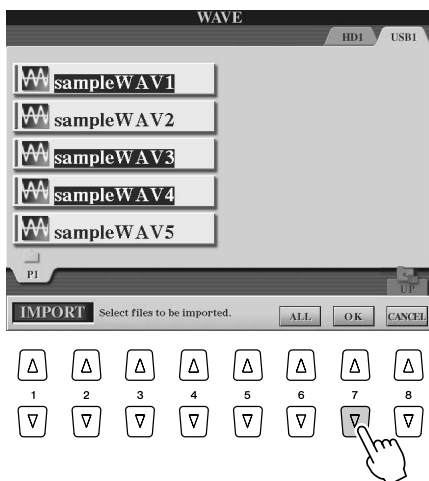

▶ 7 At the prompt, press the [YES] LCD button ([F] button).

To cancel, press the [NO] LCD button.

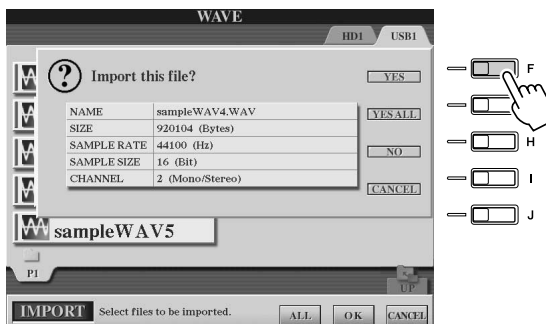

⚠ CAUTION

- Do not disconnect the device while the READ/WRITE lamp is on or flashing. Doing so may result in loss or corruption of the data or malfunction of the device.

📌 NOTE

- If you are importing multiple files and you cancel Import while the operation is in process, some of the files will be imported and unaffected by cancelling the operation.

Importing may take as little as a couple of seconds or as long as a few minutes, depending on the file size, as well as the number of files you are importing.

To confirm the imported file, press the [EXIT] button to display the AUDIO Open/Save display.

Exporting an Audio File

This function allows you to transfer your recorded audio files to a computer (via a USB storage device) for further editing and/or recording. (For instructions on importing the edited audio back to the Tyros2, see “Importing an Audio File” on page 137.)

Files which can be exported are:

- Stereo Wave data
- 44.1 kHz sample rate
- 16-bit resolution
- A length of less than or equal to 80 minutes

NOTE

- Exporting can only be applied to a file that has been saved. If you haven't save the recorded file yet, the display prompts you to save it before using the Export function.

▶ 1 Insert the USB device (or connecting cable) to the USB TO DEVICE terminal.

For purposes of illustration, we'll use a USB flash drive here.

▶ 2 Press the HARD DISK RECORDER [SELECT] button to call up the AUDIO display.

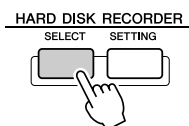

▶ 3 Press the [CHANGE MENU] LCD button (lower [8] button) if necessary, then call up the Export function by pressing the [EXPORT] LCD button (lower [5] button).

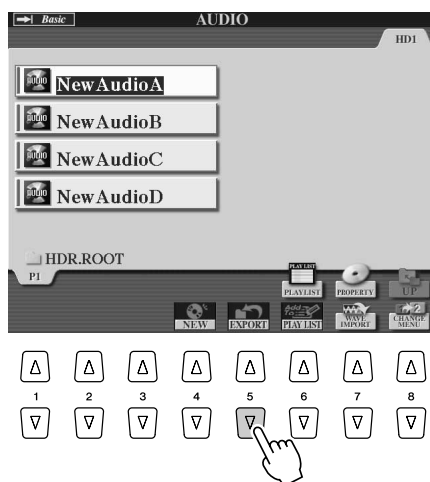

▶ 4 If necessary, select the desired folder by using the [A]–[J] buttons.

The selected folder will open.

If there are ten or more folders in the device, use the upper LCD buttons [1]–[8] to navigate through the folders.

▶ 5 Select the desired audio file by using the [A]–[J] buttons.

The selected file name is highlighted. You can continue to select additional files here, as many as desired. If multiple pages (tabs) are shown at the bottom, you can select files from these displays, too.

If you want to select all files in the current folder, press the [ALL] LCD button (lower [6] button).

After that, press the [OK] LCD button (lower [7] button).

▶ **6** Select the desired destination for exporting by using the [TAB] buttons.

Generally, a USB device will show up as “USB1” in the display. When the device is selected, all folders and audio files on the device are automatically shown.

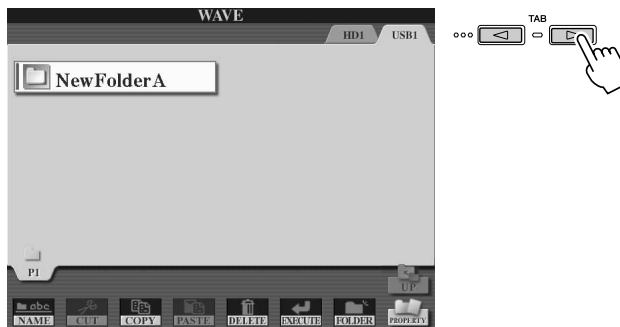

▶ **7** If necessary, select the desired folder by using the [A]–[J] buttons.

▶ **8** Press the [EXECUTE] LCD button (lower [6] button) to export the file(s).

Exporting may take as little as a couple of seconds or as long as a few minutes, depending on the file size, as well as the number of files you are exporting.

The audio file is exported to the device in stereo Wave format (44.1 kHz sample rate and 16-bit resolution) and can now be transferred to a computer for editing.

CAUTION

- Do not disconnect the device while the READ/WRITE lamp is on or flashing. Doing so may result in loss or corruption of the data or malfunction of the device.

NOTE

- If you are exporting multiple files and you cancel Export while the operation is in process, some of the files will be exported and unaffected by cancelling the operation.

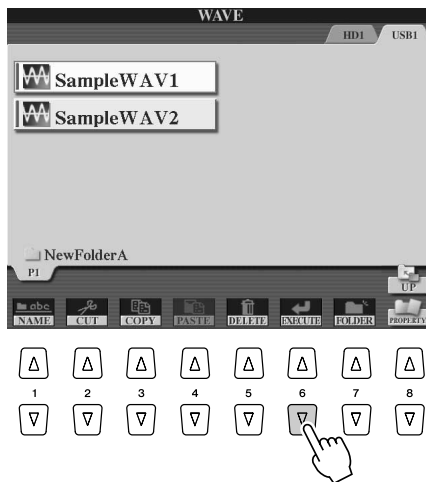

Re-recording

You can re-record the data which you created by the following four ways.

- Replace the whole data: **NORMAL REC**..... See below
- Mix the recorded data: **NORMAL REC (PLUS PLAYBACK)** See below
- Replace a certain range of the data: **PUNCH IN/OUT** page 143
- Overdub a certain range of the data: **PUNCH IN/OUT (MERGE)** page 143

NOTE

• Re-recording of the data repeatedly will result in deterioration of the sound quality.

■ NORMAL REC/NORMAL REC (PLUS PLAYBACK)

You can replace the whole audio data by NORMAL or mix the audio data with the previous one by NORMAL REC (PLUS PLAYBACK). The NORMAL REC (PLUS PLAYBACK) method does not add any tracks but simply mixes the new recording to the existing data. (Keep in mind that the Hard Disk Recorder in this instrument is a simple stereo recorder.) After stopping recording, the data will be erased from the stop point.

NOTE

• Since you will be overdubbing parts onto this audio, it's best to keep the first recording simple. For example, you may want to record just a rhythm pattern (such as by playing back a style) or a simple bass riff over which you can add other parts.

- ▶ **1** Press the **HARD DISK RECORDER [SELECT]** button and select the recorded file to be re-recorded from the **AUDIO Open/Save** display.

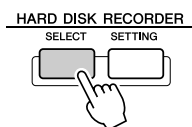

- ▶ **2** Press the **HARD DISK RECORDER [SETTING]** button, then use the **[TAB]** buttons to select the **REC MODE** tab.

- ▶ **3** Use the **[A]/[B]** buttons to select a recording method.

Replace the whole data: **NORMAL REC**
 Mix the recorded data: **NORMAL REC (PLUS PLAYBACK)**

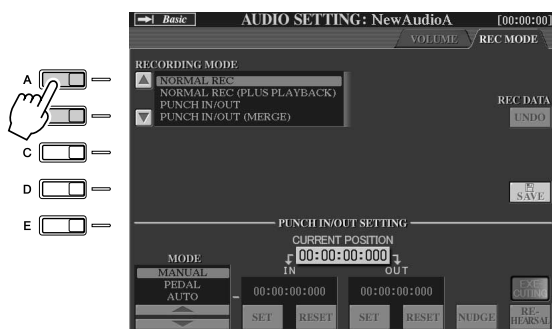

- ▶ **4** If you select **NORMAL REC (PLUS PLAYBACK)** in the step above, play back the recorded audio and practice the part that you want to overdub while the audio is playing. Change the volume settings if necessary.

If you wish to add a keyboard-played voice from the Tyros2, select the desired voice. If you wish to record your singing voice or an external instrument, connect a microphone or instrument and make the appropriate settings (page 47). Adjust the HDR Track Play and Rec Monitor levels here as desired.



HDR PLAY BALANCE	This determines the playback level of the recorded file. It does not affect the level of the recording. Simultaneously pressing both [1] buttons restores the default value.
HDR TRACK PLAY	This determines the level of the playback track for recording purposes. Use this with Rec Monitor below to adjust the relative balance of the previously recorded audio and the audio you will be overdubbing. Simultaneously pressing both [4] buttons restores the default value.
MUTE	This mutes playback of the recorded file.
REC MONITOR	This determines the level of the audio to be recorded. Use this with HDR Track Play above to adjust the relative balance of the audio you will be overdubbing and the previously recorded audio. Simultaneously pressing both [6] buttons restores the default value.
NORMALIZE	See on page 143.

- ▶ **5** Press the **[REC]** button to enable recording.

The display automatically switches to the REC MODE tab.

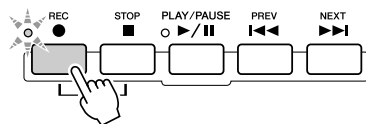

- ▶ **6** Press the **[PLAY/PAUSE]** button to start recording.

Play the keyboard (or sing, etc.) and record your performance.

- ▶ **7** When finished recording, press the **[STOP]** button.

After stopping recording, the data will be erased from the stop point.

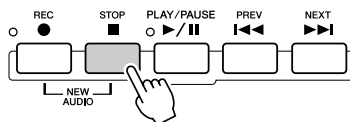

- ▶ **8** To hear your new recording, press the **[PLAY/PAUSE]** button.

If you've made a mistake or you're not completely satisfied with your performance, you can use the Undo function to erase the latest take and try again (starting with Step 5 above). For details, see the box "Undo/Redo" on page 143.

- ▶ **9** Save the recording.

For details on the Save operation, see page 75.

NOTE

- The Hard Disk Recorder automatically reduces the level of the previous track by a certain, slight amount to accommodate the new recording. This is done to minimize possible distortion. You can the Normalize effect to maximize the volume of the overall sound. For details, see the box "Normalize" on page 143.

CAUTION

- Keep in mind that even if you neglect to save the recorded data in this step, the originally recorded file (before re-recording) will still remain on the hard disk drive.

Normalize

Normalize raises the volume of the recorded audio to the optimum level. Use this to make the recorded audio as loud as possible, without distortion.

Technically, this operation scans the recorded file for the highest level, then raises the volume of the entire file so that the highest peak is set to the maximum, non-distorting level. Normalization is calculated for the loudest signal found in either channel of the stereo recording and the same gain is applied to both channels.

- 1 Make sure that the Volume page is selected.
- 2 Press the [NORMALIZE] LCD button ([G] button).
- 3 At the prompt, press the [OK] LCD button ([G] button) to start Normalizing the file.

To cancel the operation, press the [CANCEL] LCD button ([H] button).

NOTE

- Normalize can only be applied to a file that has been saved. If you haven't saved the recorded file yet, the display prompts you to save it before using Normalize.

Undo/Redo

When you make repeated changes to an audio file by overdubbing, the Undo function lets you quickly “undo” your most recent recording and restore the previous version of the data.

- 1 Make sure that the Rec Mode page is selected.
- 2 Press the [UNDO] LCD button ([G] button).

The latest recording that you made is cancelled and the previous version is restored. Also, the [UNDO] LCD button changes to [REDO], letting you reverse the process and restore the latest recording.

NOTE

- Undo/Redo can only be used on a recorded file that has not yet been saved. Once you save a file, the [UNDO] LCD button is “ghosted” and cannot be used.
- If you start recording by pressing the [REC] button and stop recording without recording any sounds, the [UNDO] LCD button is “ghosted” and cannot be used.

■ PUNCH IN OUT / PUNCH IN OUT (MERGE)

This method of recording can only be used on an existing recording. It allows you to re-record over a specific part of the already-recorded material. You can replace the original part with the new recording by PUNCH IN/OUT, or keeping the original and mixing it with the new by PUNCH IN/OUT (MERGE). This lets you either correct a mistake in the recording or overdub new parts onto the original recording.

Keep in mind that the parts before and after the Punch In/Out section are not recorded over and remain as the original data—they play back normally to guide you in and out of the recording.

- ▶ **1** Press the HARD DISK RECORDER [SELECT] button and select the recorded file to be re-recorded from the AUDIO Open/Save display.
- ▶ **2** Press the HARD DISK RECORDER [SETTING] button, then use the [TAB] buttons to select the REC MODE tab.

NOTE

- You can re-record over only one range at one time.

NOTE

- The beginning and ending of the recorded data using the Punch In/Out function is faded in/out automatically. This is done to minimize possible noise at the beginning and ending of the recorded data. We recommend that you specify the beginning and ending points at sections in the data where the volume is low.

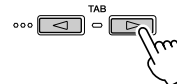
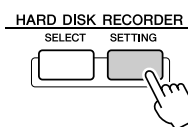

- ▶ **3** Use the [A]/[B] buttons to select a recording method.

Re-record over a specific part of the already-recorded material: **PUNCH IN/OUT**

Mix a specific part of the already-recorded material: **PUNCH IN/OUT (MERGE)**

► 4 Select the desired Punch In/Out Mode, using the [1]/[2] LCD buttons.

MANUAL	This lets you manually execute Punch In/Out recording by using the Hard Disk Recorder transport buttons ([REC], [PLAY/PAUSE], etc.).
PEDAL	This lets you manually execute Punch In/Out recording by using a connected footswitch to the FOOT PEDAL 2 jack.
AUTO	This lets you specify the Punch In and Out points, allowing automatic Punch In/Out recording (see below).

Specifying the recording range in AUTO mode

If you select AUTO as the punch in/out recording method, specify the recording range and practice the recording by using the Rehearsal function.

1 Specify the punch in/out range by pressing the [SET] LCD buttons ([3]/[5] button) at the punch in/out point during the audio song playback.

2 If you move the punch in/out point slightly, use the Nudge function.

In this Nudge function, you can move the punch in/out point slightly (even in millisecond units) while listening to the playback.

2-1 Press the [NUDGE] LCD button ([7] button) to show the Nudge Play display.

2-2 Use the [DATA ENTRY] dial and [PREV]/[NEXT] button to move the NUDGE DATA POSITION to the desired punch in/out position while listening to the playback (500 milliseconds loop playback before/after the specified point).

The [DATA ENTRY] dial lets you adjust the point in seconds and the [PREV]/[NEXT] buttons lets you adjust in milliseconds.

2-3 Press the [MODE] LCD button ([7] button) to select After/Before.

“After” repeats 500 milliseconds after the Nudge Data Position and

“Before” repeats 500 milliseconds before the Nudge Data Position when you playback the data in the next step.

2-4 Press the [SET] LCD button ([3]/[5] button) to set the moved point.

To reset the point to the start/end point of the data, press the [RESET] LCD button.

2-5 Press the [CLOSE] LCD button ([8] button).

3 Use the REHEARSAL function to practice the recording before the actual recording.

3-1 Press the [REHEARSAL] LCD button ([8] button).

“EXECUTING” is shown above the [8] buttons.

3-2 Press the HARD DISK RECORDER [REC] button and press the [PLAY/PAUSE] button.

The audio song is played back repeatedly starting four seconds before the punch in point to four seconds after the punch out point. Play the keyboard or sing the desired part in practice. In this rehearsal function, recording is not started.

3-3 Press the HARD DISK RECORDER [STOP] button.

NOTE

- The smallest possible range of the Auto punch in/out function is 100 milliseconds.

NOTE

- The repeat playback of the rehearsal function is automatically stopped after playing back 99 times.

▶ **5 Record the specific part of the audio song using the one of the methods below.**

● **Manual**

Press the HARD DISK RECORDER [REC] button and press the [PLAY/PAUSE] button to engage the record mode, then press the [REC] and [PLAY/PAUSE] buttons simultaneously to actually record. To stop recording, press the HARD DISK RECORDER [STOP] button. Pressing the HARD DISK RECORDER [PLAY/PAUSE] button during recording pauses the recording.

● **Pedal**

Press the HARD DISK RECORDER [REC] button and press the [PLAY/PAUSE] button to engage the record mode, then press and hold the footswitch. The point at which you press the footswitch is the punch in point and the point at which you release the pedal is the punch out point.

● **Auto**

Press the HARD DISK RECORDER [REC] button and press the [PLAY/PAUSE] button. Recording automatically starts and stops at the specified point in “Specify the recording range in AUTO mode” above. The audio song playback automatically stops four seconds after the punch out point.

▶ **6 Listen back to the newly edited recording. If you’re satisfied with the results, save the recording. If not, use the Undo function to restore the original, then attempt the Punch In/Out recording again.**

To save the recording, press the [SAVE] LCD button ([I] button), then press the [OK] LCD button ([G] button).

To Undo the new recording, press the [UNDO] LCD button ([G] button).

Setting the Start/End points of the audio

This function (within the Property window) lets you set the Start and End points for the audio file. This action is non-destructive and affects only the playback of the data; it does not actually delete any data from the start or end of the file.

- ▶ **1** Select the desired audio file (from the Select display).
- ▶ **2** Press the [PROPERTY] LCD button (upper [7] button).
- ▶ **3** Press the [START/END POINT] LCD button ([H] button).
- ▶ **4** Specify the Start/End point.

The operation of specifying the Start/End points is same as specifying the punch in/out points. For instructions, see “Specify the recording range in AUTO mode” on page 144.

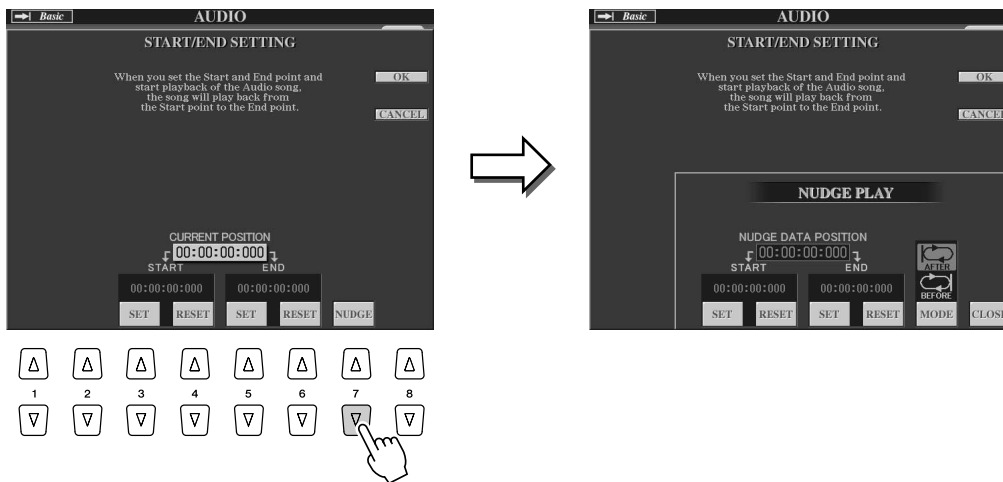

- ▶ **5** Press the [OK] LCD button ([F] button) to enter the new settings to the file.
To cancel the operation, press the [CANCEL] LCD button ([G] button).
- ▶ **6** Press the [OK] LCD button ([F] button) to exit from the Property window.

NOTE

- When exporting a song for which the Start/End points have been specified, only the specified range will be exported.

Playlist mode

The Playlist is a convenient feature within the Hard Disk Recorder that lets you collect and organize audio files for automatic playback in “jukebox” fashion. The Playlist mode can be active in the background (for example, when the Main display is selected), letting you play the listed files whenever you wish during your performance.

The “Basic/Playlist” indicator at the upper left of the display shows whether the Hard Disk Recorder is set to the Basic mode (playback of a single file) or the Playlist mode (automatic playback of multiple files).

Creating a Playlist

Once you have a number of recorded or imported audio files on the installed hard disk drive, you can assign those files to the Playlist. The files can be put in any order and can be entered any number of times (in other words, a single file can have multiple instances in a Playlist). The Playlist cannot be saved except to the installed hard disk drive, and only one Playlist can be saved to the drive.

NOTE

- A Playlist can contain a maximum of 500 audio files.

- ▶ **1** Press the HARD DISK RECORDER [SELECT] button to call up the AUDIO display.

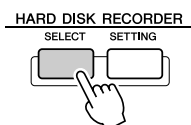

- ▶ **2** Select the appropriate folder containing the desired audio files by using the LCD buttons.
- ▶ **3** Press the [CHANGE MENU] LCD button (lower [8] button) if necessary, then press [Add to PLAYLIST] LCD button (lower [6] button).

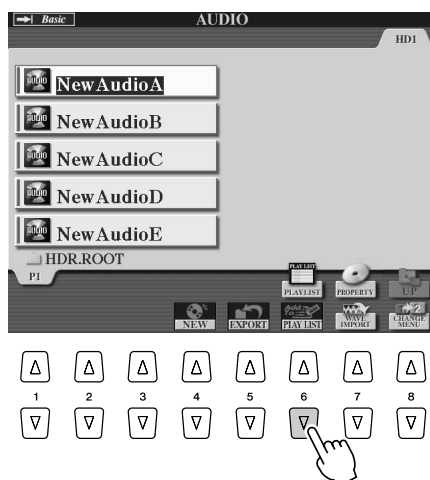

▶ **4 Select the desired audio file(s) by using the [A]–[J] buttons.**

The selected file name is highlighted. You can continue to select additional files here, as many as desired. If multiple pages (tabs) are shown at the bottom, you can select files from these displays, too.

NOTE
 • If you want to select all but a few of the files in the folder, a quick method is to use the [ALL] LCD button to select all of the files, then use the [A]–[J] buttons to de-select specific files.



To select all the files in the current folder, press the [ALL] LCD button (lower [6] button).

▶ **5 Press the [OK] LCD button (lower [7] button).**

To cancel the operation, press the [CANCEL] LCD button (lower [8] button).

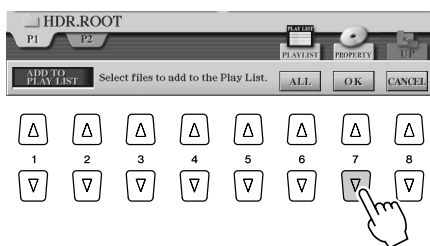

▶ **6 Check the Playlist to confirm that the files have been added.**

If the Playlist already has audio files, additional files are automatically put at the end of the list. Added files are also automatically selected (checkmarked) for playback.

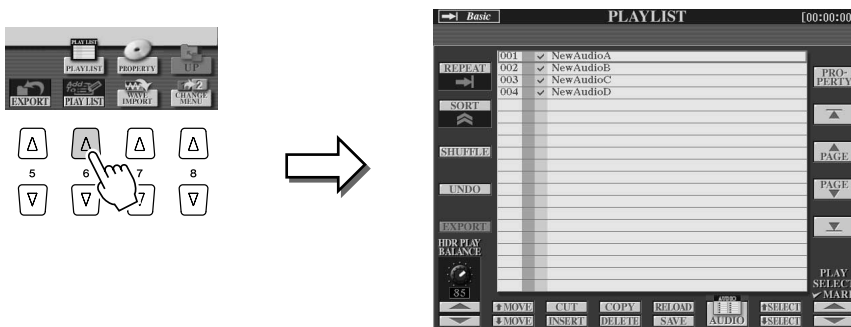

▶ **7 Save the Playlist.**

Press the [SAVE] LCD button (lower [5] button). The Playlist cannot be saved except to the installed hard disk drive, and only one Playlist can be saved to the drive.

Playing a Playlist

Once you've created and/or edited a Playlist (page 147) and you've enabled the Playlist mode, you can play back the files in the list—at any time during your performance.

Keep in mind that playback of files is not instantaneous. Since the Hard Disk Recorder needs to load each file before playing it, playback pauses roughly one or two seconds between files.

- 1 Press the Hard Disk Recorder [SELECT] button to call up the AUDIO display.

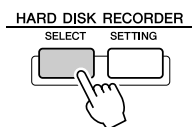

- 2 Press the [PLAYLIST] LCD button (upper [6] button).



NOTE

- The [SELECT] button toggles between the Audio and Playlist displays within the Hard Disk Recorder function.

- 3 Use the [SELECT] LCD buttons ([7] buttons) to select a file for playback.

After a couple of seconds, the selected file is highlighted in green. To have the files playback from the beginning of the Playlist, select the first file. A check mark indicates the file is enabled for playback, a minus sign (-) indicates the file will be skipped, and an exclamation mark indicates the file does not contain data.

The Playlist mode will be active when you select a file in the Playlist.

Note that the indicator at the top left of the display now shows "Playlist."

While the Playlist mode is active, the HARD DISK RECORDER [PREV]/[NEXT] buttons function as Previous/Next controls for the Playlist. Pressing the appropriate button calls up a pop-up window and selects the previous or next audio file in the Playlist. You can then use the [PLAY/PAUSE] button to start playback of the Playlist from the selected file.

NOTE

- To select a file, you can also use the [DATA ENTRY] dial to move the cursor and press the [ENTER] button to actually select the song.

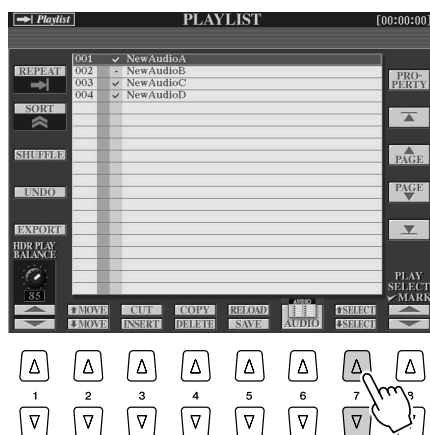

- ▶ **4** Press the **HARD DISK RECORDER [STOP]** button to stop playback.

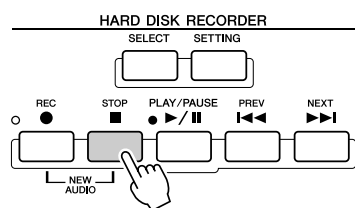

To disengage the Playlist mode, press the [AUDIO] LCD button ([6] buttons) to show the AUDIO Open/Save display and select an audio song.

Playlist Controls

Shown here is a sample Playlist display, with short explanations of the various controls.



1 REPEAT

Determines how the audio files will be played back:

- : All files are played in sequence once through to the end (no repeat).
- : All files are played in sequence repeatedly.
- : One selected file is played repeatedly.

2 SORT

Determines whether the audio files are sorted in ascending or descending order by name.

3 SHUFFLE

Pressing this button randomly rearranges the order of the files.

4 UNDO/REDO

Pressing this button (Undo) cancels the last action made to the Playlist. Pressing it again (Redo) restores the cancelled action. Only one level of Undo/Redo is available.

5 EXPORT

Calls up the Export operation for exporting the selected audio file to a hard disk drive or USB storage devices. (See "Exporting an Audio File" on page 139.)

6 HDR PLAY BALANCE

Determines the playback volume for the entire Playlist. Keep in mind that the playback volume of individual files can be set within each file itself.

7 MOVE Up/Down

Use these buttons to move the selected file to another location in the list.

8 CUT / COPY / INSERT / DELETE

These operations let you copy or cut and paste individual list entries. Keep in mind that these have no effect on the actual audio data, but just entries in the list.

Cut and Insert

- 1) Press the [CUT] LCD button (upper [3] button) and select the desired file entry by using the [DATA ENTRY] dial and [SELECT] LCD button (lower [5] button). The entry is deleted.
- 2) Move the cursor to the desired location in the list (with the [SELECT] buttons) and press the [INSERT] LCD button (lower [3] button).

Copy and Insert

- 1) Press the [COPY] LCD button (upper [4] button) and select the desired file entry by using the [DATA ENTRY] dial and [SELECT] LCD button (lower [5] button). The entry is copied.
- 2) Move the cursor to the desired location in the list (with the [SELECT] buttons) and press the [INSERT] LCD button (lower [3] button).

Delete

Deletes files from the Playlist. Keep in mind that this does not affect the actual audio data, but simply deletes an entry of the file from the list.

9 RELOAD

For reloading the saved Playlist.

10 SAVE

For saving the Playlist to the installed hard disk drive. Once you have saved the data, the Undo/Redo function is not available.

11 AUDIO

Calls up the Audio Open/Save display. (Page 147)

12 SELECT Up/Down

Use these buttons to select file entries in the list. A red border appears around the selected entry, and then the entire entry is highlighted in green when actually selected. Use the [DATA ENTRY] dial to quickly move the cursor (red border) through the entries and press the [ENTER] button.

13 PLAY SELECT

These buttons determine whether the selected file is enabled for playback or not. Select a file (using the [SELECT] buttons above), then press the upper [8] button to checkmark (enable) the file, or press the lower [8] button to remove the checkmark (disable) for the file. Pressing and holding the upper [8] button checks all files, while pressing and holding the lower [8] button unchecks all files.

14 Playlist navigation controls

- : Moves cursor/selection to the top of the list.
- : Moves cursor/selection one page up (when there are multiple pages).
- : Moves cursor/selection one page down (when there are multiple pages).
- : Moves cursor/selection to the bottom of the list (just below last entered file).

15 PROPERTY

Calls up the Property popup display which shows the file name and path of the audio song at the cursor position.

Style Playback (Auto Accompaniment)

Quick Guide on pages 31–37 →

This section explains important style-related operations not covered in the Quick Guide. For basic information on playing styles, refer to the Quick Guide.

Style Characteristics

The style type and its defining characteristics are indicated above the Preset style name.

Pro	These styles provide professional and exciting arrangements combined with perfect playability. The resulting accompaniment exactly follows the chords of the player. As a result, your chord changes and colorful harmonies are instantly transformed into lifelike musical accompaniment.
Session	These styles provide even greater realism and authentic backing by mixing in original chord types and changes, as well as special riffs with chord changes, with the Main sections. These have been programmed to add “spice” and a professional touch to your performances of certain songs and in certain genres. Keep in mind, however, that the styles may not necessarily be appropriate—or even harmonically correct—for all songs and for all chord playing. In some cases for example, playing a simple major triad for a country song may result in a “jazzy” seventh chord, or playing an on-bass chord may result in inappropriate or unexpected accompaniment.

Chord Fingerings

The chords (or simplified chord indications) you play in the left-hand section of the keyboard are used for several performance functions:

- When [ACMP] is turned on (page 31), the left-hand section of the keyboard becomes the Chord section and the selected style is played back according to the chords specified in the left-hand section of the keyboard. The specified chords are also used for Vocal Harmony (page 48), the Harmony (Voice) effect (page 39), and the Multi Pads (when used with Chord Match; page 38).
- When the [ACMP] is turned off (page 31) and the LEFT part is turned on, the notes played as the Left part are recognized as chords. These chords have no effect on style playback, but are used for Vocal Harmony (page 48), the Harmony (Voice) effect (page 39), and the Multi Pads (when used with Chord Match; page 38).

There is also a convenient Chord Tutor function that shows you which notes you need to play to make certain chords. (Press [FUNCTION] → CHORD FINGERING.)

The explanations here show how to specify chords. Call up the [FUNCTION] → CHORD FINGERING display and follow the instructions below.

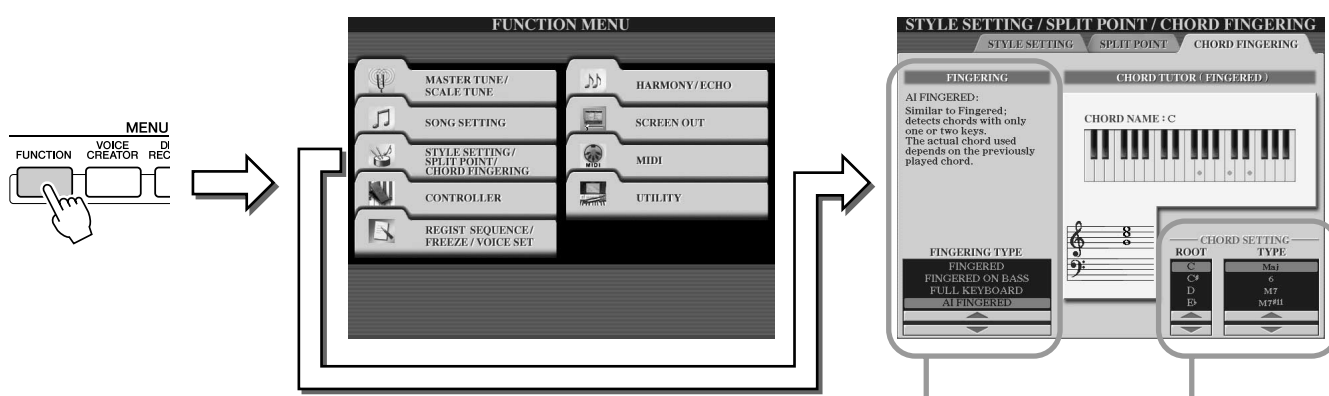

Selects the fingering type, which determines how the chords are specified (which notes you should play). See below for details.

Chord Tutor
Specify the Chord Root and Type here, and the notes of the chord are indicated in the keyboard illustration above. Depending on the chord, some notes may be omitted.

■ Seven types of Chord Fingerings

● SINGLE FINGER

Makes it simple to produce orchestrated accompaniment using major, seventh, minor and minor-seventh chords by pressing a minimum number of keys on the Chord section of the keyboard. The abbreviated chord fingerings described below are used:



For a major chord, press the root key only.



For a seventh chord, simultaneously press the root key and a white key to its left.



For a minor chord, simultaneously press the root key and a black key to its left.



For a minor-seventh chord, simultaneously press the root key and both a white and black key to its left.

● MULTI FINGER

Automatically detects Single Finger or Fingered chord fingerings, so you can use either type of fingering without having to switch fingering types.

● FINGERED

Lets you finger your own chords on the Chord section of the keyboard, while the Tyros2 supplies appropriately orchestrated rhythm, bass, and chord accompaniment in the selected style. The Fingered recognizes the various chord types which are listed on the separate Data List booklet and can be looked up using the Chord Tutor function above.

● FINGERED ON BASS

Accepts the same fingerings as the Fingered, but the lowest note played in the Chord section of the keyboard is used as the bass note, allowing you to play “on bass” chords (in the Fingered mode the root of the chord is always used as the bass note).

● FULL KEYBOARD

Detects chords in the entire key range. Chords are detected in a way similar to Fingered, even if you split the notes between your left and right hands—for example, playing a bass note with your left hand and a chord with your right, or by playing a chord with your left hand and a melody note with your right.

● AI FINGERED

Basically the same as FINGERED, with the exception that less than three notes can be played to indicate the chords (based on the previously played chord, etc.).

● AI FULL KEYBOARD

When this advanced fingering type is engaged, the Tyros2 will automatically create appropriate accompaniment while you play just about anything, anywhere on the keyboard using both hands. You don't have to worry about specifying the style chords. Although the AI Full Keyboard type is designed to work with many songs, some arrangements may not be suitable for use with this feature. This type is similar to FULL KEYBOARD, with the exception that less than three notes can be played to indicate the chords (based on the previously played chord, etc.). 9th, 11th and 13th chords cannot be played. This type is effective only when a style is being played back.

The following list shows the conditions in which the notes played in the left-hand section of the keyboard can be recognized as a chord.

Selected Fingering type	[ACMP] off, LEFT part off	[ACMP] off, LEFT part on	[ACMP] on, LEFT part off	[ACMP] on, LEFT part on
SINGLE FINGER	Not recognized	Recognized via FINGERED	Recognized via the selected Fingering type.	Recognized via the selected Fingering type.
MULTI FINGER	Not recognized	Recognized via FINGERED	Recognized via the selected Fingering type.	Recognized via the selected Fingering type.
FINGERED	Not recognized	Recognized via the selected Fingering type.	Recognized via the selected Fingering type.	Recognized via the selected Fingering type.
FINGERED ON BASS	Not recognized	Recognized via the selected Fingering type.	Recognized via the selected Fingering type.	Recognized via the selected Fingering type.
FULL KEYBOARD	Not recognized	Recognized via the selected Fingering type.	Recognized via the selected Fingering type.	Recognized via the selected Fingering type.
AI FINGERED	Not recognized	Recognized via the selected Fingering type.	Recognized via the selected Fingering type.	Recognized via the selected Fingering type.
AI FULL KEYBOARD	Not recognized	Not recognized	Recognized via the selected Fingering type.	Recognized via the selected Fingering type.

Fade In/Out

The [FADE IN/OUT] button can be used to produce smooth fade-ins and fade-outs when starting and stopping the style/song playback. This affects the overall sound of the Tyros2—including the your keyboard performance and the Multi Pads, as well as the styles and songs.

- ▶ **1 Press the [FADE IN/OUT] button so that its indicator lights.**
- ▶ **2 Start the style playback.**
The sound will gradually fade in. The [FADE IN/OUT] indicator will flash during the fade-in, and then go out when full volume has been reached.
- ▶ **3 Press the [FADE IN/OUT] button again so that its indicator lights.**
The indicator will flash during the fade out, then the style playback will stop when the fade-out is complete.



NOTE

- The time of the fade-in/fade-out can also be set (page 193).
- Fade in /out function does not affect the audio song playback.

Tempo

Each style of the Tyros2 has been programmed with a default or standard tempo; however, this can be changed to any value between 5 and 500 beats per minute by using the [TEMPO] button. This can be done either before the style playback is started or while it is playing. You can determine whether the current tempo is maintained or is reset to the default tempo of a newly selected style (while a style is being played back) by using the Style Change Behavior (Tempo Hold/Reset) function (page 158).

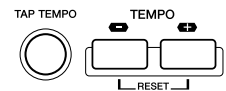

■ Tap function

This useful function lets you press the [TAP TEMPO] button to tap out the tempo and automatically start the style at that tapped speed. Simply tap (press/release) the button (four times for a 4/4 time signature), and the style playback starts automatically at the tempo you tapped. The tempo can also be changed during playback by tapping the button twice at the desired tempo.

● When a 4-beat style is selected

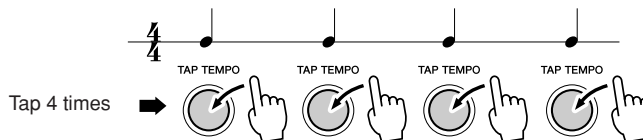

* When a 3-beat style is selected, tap 3 times.

Synchro Start and Synchro Stop

Quick Guide on page 31 ➔

When [SYNC START] (Synchro Start) is turned on, you can automatically have style playback start as soon as you play a chord in the chord section of the keyboard. When [SYNC STOP] (Synchro Stop) is on, the accompaniment plays as long as you hold a chord. In other words, you can abruptly stop the accompaniment simply by releasing your left hand from the keyboard. Since turning on [SYNC STOP] automatically enables [SYNC START] as well, you can instantly start up and stop the accompaniment by alternately playing chords and releasing them.

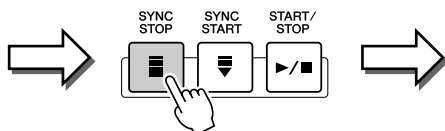
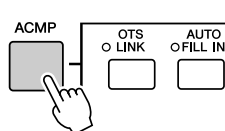

Turning on the [SYNC STOP] button automatically turns on the [SYNC START] button as well. Turning it off turns both buttons off.

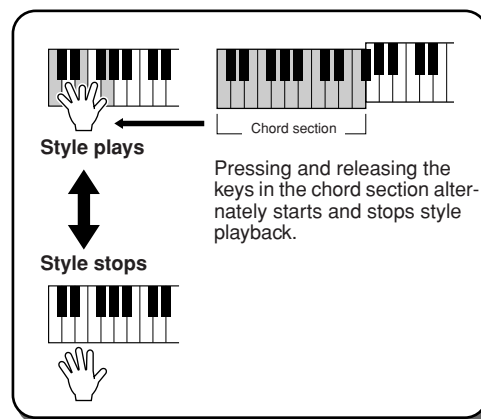

NOTE

- Holding the chord for more time specified in the [FUNCTION] → STYLE SETTING/SPLIT POINT display (page 157) will cancel the Synchro Stop function even if [SYNC STOP] is turned on.
- Synchro Stop cannot be set to on when the Fingering is set to Full Keyboard/All Full Keyboard or [ACMP] is turned off.

Programmable One Touch Setting (OTS)

Quick Guide on page 36 ➔

One Touch Setting (OTS) is a convenient function that allows you to call up the most appropriate panel settings for the currently selected style—with the touch of a single button. Press any one of the four [ONE TOUCH SETTING] buttons to instantly call up the following pre-programmed settings for style play.

- [ACMP] and [SYNC START] are automatically turned on, letting you start the style as soon as you play a left-hand chord on the keyboard.
- Custom panel settings (for voices, keyboard parts, effects, etc.) designed to best match the selected style are automatically called up—letting you instantly reconfigure the instrument to suit the music you play.

The Tyros2 actually has three different features that let you instantly call up complete panel setups: One Touch Setting (described here), Music Finder, and Registration Memory. One Touch Setting differs from the other two in that each OTS panel setting is dedicated to a particular style—first, you select a style for your performance, then you press a [ONE TOUCH SETTING] button to match the panel settings to that style.

■ OTS Link.....

The convenient OTS (One Touch Setting) Link function lets you automatically have One Touch Settings change when you select a different Main section (A–D). The Main sections A, B, C, and D correspond to One Touch Settings 1, 2, 3, and 4, respectively. This is especially powerful for live performance situations, letting you instantly and easily reconfigure the instrument as you play.



■ Memorizing the panel settings to the OTS.....

The Tyros2 features four different One Touch Settings for each of the preset styles. Though each has been specially programmed to match the style, you can change the settings as desired. The changed One Touch Settings can be saved as the selected style to the User drive or external devices.

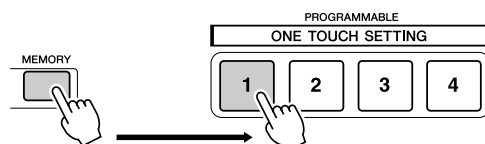

Press the [MEMORY] button of Registration Memory and press any of the [ONE TOUCH SETTING] buttons.

⚠ CAUTION

- Make sure to save your OTS settings as a style file to the User drive or external devices (see Save operation instructions on page 75, step #2 to end). The panel settings memorized to each OTS button will be lost if you change the style or turn the power off without executing the Save operation.

Instant Style Selection

If you've created your own styles and built up a collection of style data on the User drive or external devices, you'll soon have many style files to select from—making it difficult to call up your favorite styles. This function lets you memorize the path of a specific style to a specific STYLE button. Even if your data is scattered across the drive in a complex hierarchy of folders and paths, you can instantly call up a specific file—no matter how deeply hidden—with a single button-press.

- ▶ **1** Call up the Open/Save display for styles with the Number Input Type (page 77).
- ▶ **2** First, select the style to be memorized by calling up the appropriate path, then press the [MEMORY] LCD button.

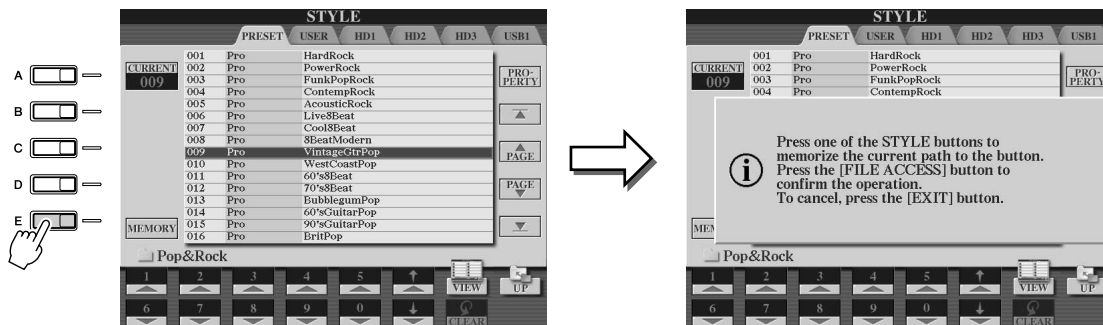

- ▶ **3** Check that the path set in step #2 above has been properly memorized. First, call up a different path (for example, the Open/Save display for voices), then select the path just memorized by turning on the [FILE ACCESS] button and pressing the appropriate STYLE button.

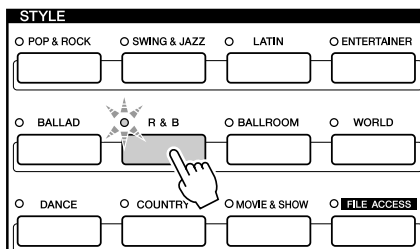

- ▶ **4** Call up the other path (for example, the Open/Save display for voices) and call up the path memorized in step #3 by following the instructions below.

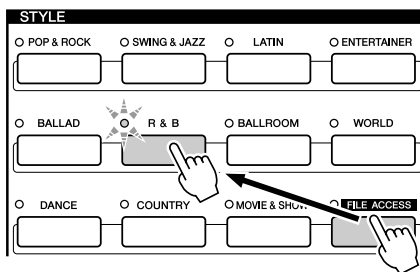

Turn [FILE ACCESS] on and press appropriate STYLE button (set in step #3 above).

Style Playback Related Settings

The Tyros2 has a variety of style playback functions, including Split Point and many others—which can be accessed by pressing [FUNCTION] → STYLE SETTING/SPLIT POINT.

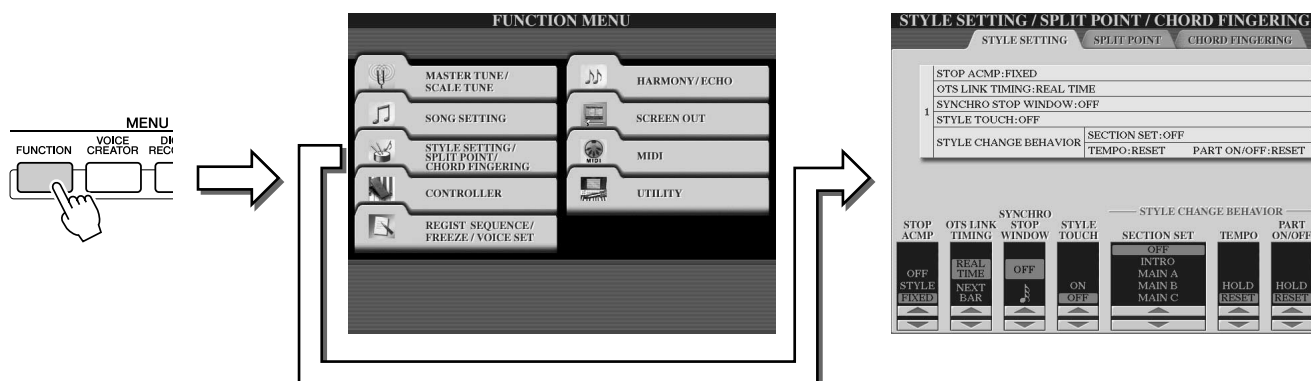

Style Settings

■ Stop Accompaniment

When auto accompaniment is turned on and Synchro Start is off, you can play chords in the left-hand (accompaniment) section of the keyboard with the style stopped, and still hear the accompaniment chord. In this condition—called “Stop Accompaniment”—any valid chord fingerings are recognized and the chord root/type are shown in the LCD. Since the Tyros2 properly recognizes the chord, you can also use the Chord Match function (page 38) with the Multi Pads or the Harmony effect (page 39) without having to play back a style.

From the display above, you can determine whether the chord played in the chord section will sound or not in the Stop Accompaniment status.

- OFF The chord played in the chord section will not sound.
- STYLE The chord played in the chord section will sound via the voices for the Pad part and the Bass channel of the selected style.
- FIXED The chord played in the chord section will sound via the certain voice regardless of the selected style.

NOTE

- The chord detected by playing the Stop Accompaniment can be recorded to a song regardless of the setting here. Please note that the voice sound will be recorded when set to “STYLE,” and will not be recorded when set to “OFF” or “FIXED.”

■ OTS Link Timing

This applies to the OTS Link function (page 155). This parameter determines the timing in which the One Touch Settings change with the MAIN VARIATION [A]–[D] change. (The [OTS LINK] button must be on.)

- Real Time One Touch Setting is immediately called up when you press a [MAIN VARIATION] button.
- Next Bar One Touch Setting is called up at the next measure, after you press a [MAIN VARIATION] button.

■ Synchro Stop Window

This determines how long you can hold a chord before the Synchro Stop function is automatically cancelled. When the [SYNC STOP] button is turned on and this is set to a value other than “OFF,” this automatically cancels the Synchro Stop function if you hold a chord for longer than the time set here. This conveniently resets style playback control to normal, letting you release the keys and still have the style play.

■ Style Touch

Turns touch response for the style playback on/off. When this is set to “ON,” the style volume changes in response to your playing strength in the chord section of the keyboard.

■ Section Set

Determines the default section that is automatically called up when selecting different styles (when style playback is stopped). When set to “OFF” and style playback is stopped, the active section is maintained even if the different style is selected.

When any of the Main A-D sections is not included in the style data, the nearest section is automatically selected. For example, when Main D is not contained in the selected style, Main C will be called up.

■ Tempo

Determines whether the current tempo is maintained (HOLD) or is reset to the default tempo of a newly selected style (RESET) when you select other style in a middle of style playback.

■ Part On/Off.....

Determines whether the current Part on/off settings are maintained (HOLD) or all parts are reset to on when you select another style.

Simultaneously Playing a Song and a Style

When playing back a song and a style at the same time, channels 9–16 of the song data are replaced with style channels—allowing you to use the styles and features in place of the accompaniment parts of the song. This provides added flexibility to your performance, letting you independently control style playback and song playback.

NOTE

- The style stops when you stop the song. If the accompaniment style is playing and you start the song, the accompaniment automatically stops.
- Some of the songs have been created using the built-in styles. For these songs, the styles are automatically started when starting song playback.

Split Point

These are the settings (there are three Split Points) that separate the different sections of the keyboard: the Chord section, the LEFT part section, the RIGHT 1-2 section and RIGHT 3 section. The three Split Point settings (below) are specified as note names.

- Split Point (S)—separates the Chord section for style playback from the section(s) for playing voices (RIGHT 1-3, LEFT).
- Split Point (L)—separates the two sections for playing voices, LEFT and RIGHT 1-3.
- Split Point (R)—separates the two sections for playing the Right voices (Right 1-2, Right 3).

To set the split point, use the corresponding [1]–[6] LCD buttons (along with the data dial, if desired), or use the [F]–[I] buttons to select the desired part (“S + L” lets you adjust both Style and Left together), then rotate the [DATA ENTRY] dial, or press the desired key on the keyboard while holding the [F]–[I] buttons.

● Setting the Split Point S and L to the same note

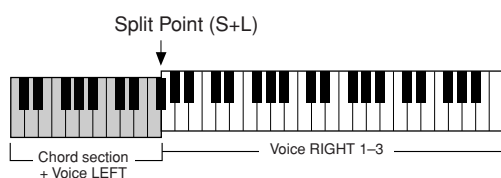

● Setting the Split Point S, L, and R to different notes

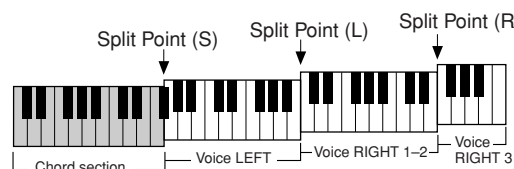

Split Point (L) cannot be set lower than Split Point (S), and Split Point (S) cannot be set higher than Split Point (L).

Style Creator (Digital Recording)

The powerful Style Creator feature lets you create your own original styles, which can then be used for style playback—just as with the preset styles.

Style Data Structure—Creating Styles

Each style is made up of fifteen sections (Intro I–III, Main A–D, Fill In A–D, Break, Ending I–III) as rhythm pattern variations. Each of these fifteen sections in turn has eight different parts (channels), made up of MIDI sequence data—making a total of 120 separate sets of MIDI data contained in a single style. With the Style Creator feature, you can create a style by separately recording the necessary MIDI data, or by importing pattern data from other existing styles.

● Using Preset Styles

As shown in the chart at right, when you select the internal preset style that is the closest to the type of style you wish to create and call up the Style Creator display, the preset style data will be copied to a special memory location for creating. You can create an original style by adding, deleting, or replacing data from this memory location.

NOTE

- The DSP1 effect settings (page 181) cannot be stored in the User style data, and as such cannot be edited in the Style Creator function. This means that any DSP1 effect settings in the Preset style (such as changing speeds of the rotary speaker effect) will be deleted from the copied Preset style data, and be unavailable for creating a style.

● Recording and Assembling

The Style Creator provides two basic ways to create MIDI sequence data of each part: Recording, which allows you to record parts from the keyboard (using Realtime or Step Recording), and Assembly, which lets you bring various pattern data together by copying from other styles. Both methods, Recording and Assembly, replace the original data with the new data.

In the case of chart shown at right, for example, INTRO I and MAIN A are created by recording the new data to all the parts, and MAIN B is created by assembling the pattern data for all parts from the other styles. INTRO III and ENDING A–C are created by keeping and using the original data. MAIN C and FILL IN A are created via three ways: Recording, Assembly, and using the original data.

Each style contains 120 MIDI data sequences (15 Sections x 8 Parts)

Section	Part	RHYTHM 1	RHYTHM 2	BASS	CHORD 1	CHORD 2	PAD	PHRASE 1	PHRASE 2
INTRO I		●	●	○	○	○	○	○	○
INTRO II		●	●	○	○	○	○	○	○
INTRO III		●	●	○	○	○	○	○	○
MAIN A		●	●	○	○	○	○	○	○
MAIN B		●	●	○	○	○	○	○	○
MAIN C		●	●	○	○	○	○	○	○
MAIN D		●	●	○	○	○	○	○	○
FILL IN A		●	●	○	○	○	○	○	○
FILL IN B		●	●	○	○	○	○	○	○
FILL IN C		●	●	○	○	○	○	○	○
FILL IN D		●	●	○	○	○	○	○	○
BREAK		●	●	○	○	○	○	○	○
ENDING I		●	●	○	○	○	○	○	○
ENDING II		●	●	○	○	○	○	○	○
ENDING III		●	●	○	○	○	○	○	○

- For these parts containing preset data, new material can be overdubbed (recorded).
- For these parts containing preset data, new material cannot be overdubbed (recorded). These parts can be recorded only after deleting their preset data.

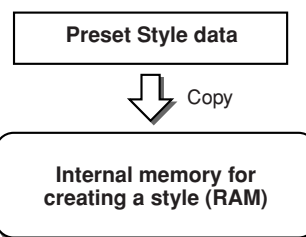

Example style—created by Recording, Assembly and original data

Section	Part	RHYTHM 1	RHYTHM 2	BASS	CHORD 1	CHORD 2	PAD	PHRASE 1	PHRASE 2
INTRO I		■	■	■	■	■	■	—	—
INTRO II		□	□	□	□	□	□	■	■
INTRO III		□	□	□	□	□	□	□	□
MAIN A		■	■	■	■	■	■	■	■
MAIN B		■	■	■	■	■	■	■	■
MAIN C		■	□	■	□	■	□	□	■
MAIN D		—	—	—	—	—	—	—	—
FILL IN A		■	■	□	■	—	■	□	□
FILL IN B		□	□	□	□	□	□	□	□
FILL IN C		□	□	□	■	□	□	□	□
FILL IN D		—	—	—	—	—	—	—	—
BREAK		□	□	■	□	□	□	□	□
ENDING I		□	□	□	□	□	□	□	□
ENDING II		□	□	□	□	□	□	□	□
ENDING III		□	□	□	□	□	□	□	□

- Creating data by recording
- Copying data from other styles (Assembly)
- No change (maintaining the original data)
- No data

● **Loop Recording and Overdub Recording**

The Song Creator (Song Recording) feature records your keyboard performance as MIDI data. Recording a style data via the Style Creator, however, is done in a different way. Here are some of the aspects in which style recording differs from song recording:

- **Loop Recording** Style playback repeats the rhythm patterns of several measures in a “loop,” and style recording is also done using loops. For example, if you start recording with a two-measure main section, the two measures are repeatedly recorded. Notes that you record will play back from the next repetition (loop), letting you record while hearing previously recorded material.
- **Overdub Recording** This method records new material to a part (channel) already containing recorded data, without deleting the original data. In style recording, the recorded data is not deleted, except when using functions such as Rhythm Clear (page 162) and Delete function (page 161). For example, if you start recording with a two-measure MAIN section, the two measures are repeated many times. Notes that you record will play back from the next repetition, letting you overdub new material to the loop while hearing previously recorded material.

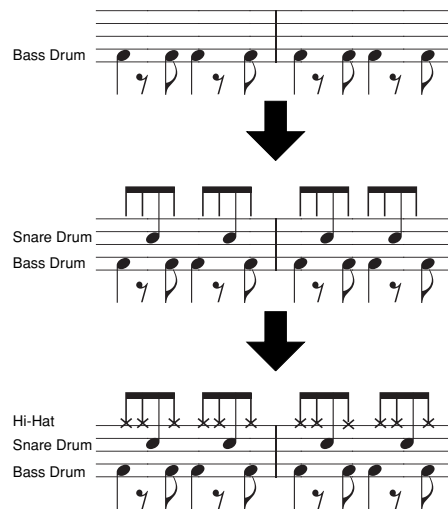

Using the recording methods above, the Style Creator feature lets you record complete rhythm patterns (like the one above) quickly and easily.

● **Rhythm Parts and Pitched Parts**

Creating or recording the Rhythm parts (containing non-pitched data) differs from recording other parts (containing pitched data) in the following ways.

- Note data can be overdubbed to existing Rhythm parts of a preset style, whereas other pitched parts can be newly recorded to only after all existing preset data on the part is deleted.
- Style parts (channels) other than Rhythm parts are played back according to the chord root/type specified in the chord section of the keyboard. The notes output from style parts (channels) other than Rhythm parts are transposed from the Source Pattern (described below) according to the chord root/type specified in the chord section of the keyboard. The Style Creator lets you set the parameters that determine how the note is transposed and set the parameters that determine how notes held through chord changes will be handled.

Special Parameter Settings based on Style File Format

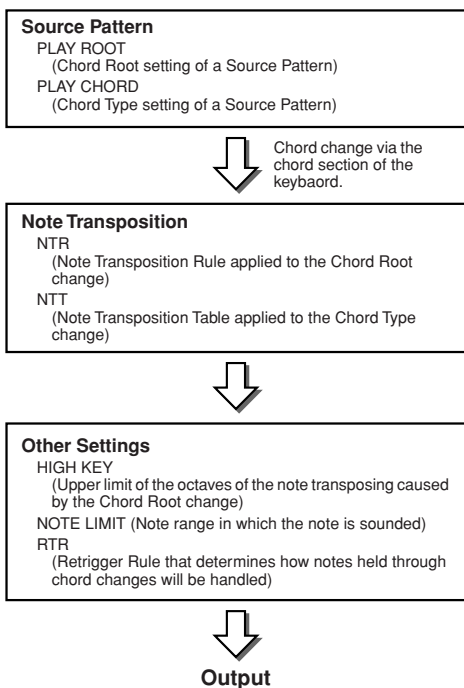

The Style File Format (SFF) combines all of Yamaha’s auto accompaniment (style playback) know-how into a single unified format. By using the Style Creator, you can take advantage of the power of the SFF format and freely create your own styles.

The chart shown at left indicates the process by which the style is played back. (This does not apply to the rhythm track.) These parameters can be set via the Style Creator feature.

- **Source Pattern**..... page 166
There are a variety of possibilities for style playback notes, depending on the particular root note and chord type that are selected. The style data is appropriately converted depending on the chord changes you make during your performance. This basic style data that you create with the Style Creator is referred to as the “Source Pattern.”
- **Note Transposition** page 166
This parameter group features two parameters that determine how the notes of the Source Pattern are to be converted in response to chord changes.
- **Other Settings** page 167
Using the parameters of this group, you can fine-tune how style playback responds to the chords you play. For example, the Note Limit parameter allows you to have the voices of the style sound as realistic as possible by shifting the pitch to an authentic range—ensuring that no notes sound outside the natural range of the actual instrument (e.g., very low notes of a piccolo sound).

Basic Procedure (Style Creator)

1 First, select the desired style and one of its sections.

2 Press the [DIGITAL RECORDING] button.

3 Press the [STYLE CREATOR] LCD button.

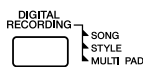
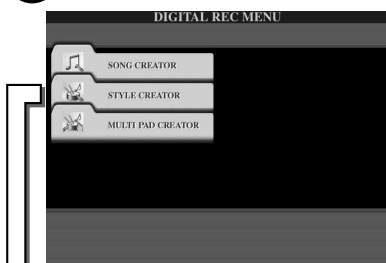

NOTE

- Only Drum Kit/SFX Kit can be selected for the RHY 2 channel.
- For the non-rhythm channels (BASS–PHR 2), all voices with the exception of the Drum Kit/SFX Kit can be selected.

NOTE

- You can also select the desired section for recording by pressing the appropriate panel button. Pressing one of the Section buttons (including the [AUTO FILL IN] button) calls up the SECTION pop-up window, from which you can change Sections.
- To actually enter the change, press the [OK] LCD button.

4 Select a section and part (channel) to be created or recorded, and set the basic parameters for style creation.

- Execute Realtime recording.
- Execute Assembly (page 163).
- Edit the already-recorded parts (channels).
- Execute Step Recording using the Event List.

CAUTION

After you've finished creating/editing a style, make sure to execute the Save operation. The recorded style will be lost if you change to another style or you turn the power off without executing the save operation (page 75).



When this button is pressed, DELETE will appear for parts which contain data. Set the desired part to "DELETE" by pressing the corresponding upper LCD button while holding this button to delete all data in the corresponding parts. The data is actually deleted when this button is released.

Set the desired part (channel) to "REC" by pressing the corresponding lower LCD button while holding the [REC CH] button. Only one part (channel) can be recorded at a time.

Press the upper button to call up the Open/Save display for voices to change the voice of the selected part. Press the [EXIT] button to return to this display. You can also turn each part's playback on/off during recording by pressing the lower LCD button.

Press this if you want to create a style from scratch by deleting all data of the selected style.

This operation corresponding to step #4 is covered in the following page.



Select a section to be created.

Select the desired number of measures for the selected section (except for FILL IN sections, which are fixed at 1 measure). Press the [EXECUTE] LCD button to actually enter the new settings, and check it by pressing the [START/STOP] button in the STYLE CONTROL section to hear style playback.

NOTE

- You cannot select Intro/Ending 4 and three Fill sections from the panel buttons.
- You cannot overdub-record (page 160) new material to any parts (channels) that contain preset data, with the exception of the Rhythm parts (channels). Make sure to delete preset data of non-Rhythm parts before recording, by using the [DELETE] LCD button above.

Basic Settings and Realtime Recording for each part (channel)

The explanations here apply when you call up the BASIC page in step #4 of the Basic Procedure above. Refer to the illustrations above for information about the basic style creation parameters. For actual instruction steps for recording, see the sections below.

Recording note events to a Rhythm part (channel)

1 Select one of the Rhythm parts as a recording part on the BASIC display (above).

- ▶ **2** Press the **STYLE CONTROL [START/STOP]** button to start recording of the Rhythm part. You can hear the selected style in a playback loop as you record. Turn the playback parts on/off as desired.
- ▶ **3** Overdub drum/percussion instruments to the part by playing the appropriate keys. You can also delete certain percussion sounds while recording. While holding the [RHY CLEAR] LCD button, press the key on the keyboard corresponding to the instrument you want to cancel. This Rhythm Clear function deletes all instances of the instrument in the part.
- ▶ **4** Press the **STYLE CONTROL [START/STOP]** button again to stop recording (looped playback).

■ Recording note events to a Bass/Chord/Pad/Phrase part (channel).....

- ▶ **1** Select one of the parts (other than a Rhythm part) by following the instructions in step #4 of “Basic Procedure” on page 161.

You cannot record new material to the Bass/Chord/Pad/Phrase part (channel) that has preset data. If the selected part to be recorded has preset data, make sure to delete it (in step #4 of “Basic Procedure” on page 161).

- ▶ **2** Start recording.

You can start recording in one of two ways:

- Press the **STYLE CONTROL [START/STOP]** button.
- Press the **STYLE CONTROL [SYNC START]** button to enable Synchro Start standby, then play a key on the keyboard.

Turn the playback parts on/off as desired.

The recording repeats indefinitely (until stopped) in a loop. Notes that you record will play back from the next repetition, letting you record while hearing previously recorded material.

Rules when recording non-rhythm parts

- Use only the CM7 scale tones when recording the BASS and PHRASE parts (i.e., C, D, E, G, A, and B).
- Use only the chord tones when recording the CHORD and PAD parts (i.e., C, E, G, and B).

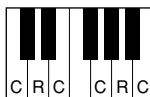

C = Chord notes
C, R = Recommended notes

Using the data recorded here, the auto accompaniment (style playback) is appropriately converted depending on the chord changes you make during your performance. The chord which forms the basis for this note conversion is called the Source Chord, and is set by default to CM7 (as in the example illustration above).

You can change the Source Chord (its root and type) from the PARAMETER display on page 165. Keep in mind that when you change the Source Chord from the default CM7 to another chord, the chord notes and recommended notes will also change. For details on chord notes and recommended notes, see page 166.

- ▶ **3** Press the **STYLE CONTROL [START/STOP]** button again to stop recording (and looped playback).

NOTE

- For the **INTRO** and **ENDING** sections, any appropriate chord or chord progression can be used. (You need not follow the rules described at left.)
- If you want to record the pattern with a Source Chord other than CM7, set the **PLAY ROOT** and **PLAY CHORD** parameters on the **PARAMETER** page (page 165) before performing step #2.

Step Recording for Notes using the Event List

The explanations here apply when you call up the **EDIT** page in step #4 of the Basic Procedure on page 161. The **EDIT** page contains the Event List, in which you can record notes with absolutely precise timing. This Step Recording procedure is essentially the same as that for Song Recording (pages 127–132), with the exception of the points listed below:

- In the Song Creator, the End Mark position can be changed freely; in the Style Creator, it cannot be changed. This is because the length of the style is automatically fixed, depending on the selected section. For example, if you create a style based on a section of four measures length, the End Mark position is automatically set to the end of the fourth measure, and cannot be changed in the Step Recording display.
- Recording channels (parts) can be changed in the Song Creator; however, they cannot be changed in the Style Creator.
- In the Style Creator, only the channel events and System Exclusive messages can be entered. Chord and Lyrics events are not available. You can switch between the two types of Event Lists by pressing the [F] button.

Assembling a Style from Existing Pattern Data

The explanations here apply when you call up the ASSEMBLY page in step #4 of the Basic Procedure on page 161. This convenient function lets you combine style elements—such as rhythm, bass, and chord patterns—from existing styles, and use them to create your own original sections and styles.

Assembling pattern data as shown below at left using “Cool 8Beat” as a basis, for example, results in the display below at right.

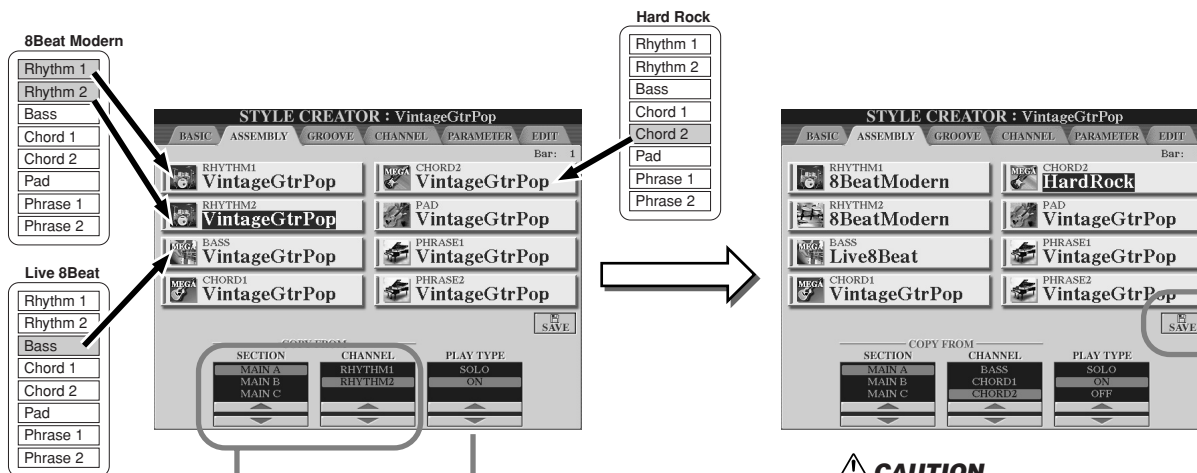

Select the desired part (channel) by pressing one of the LCD [A]–[D], [F]–[I] buttons and press the same button to call up the Open/Save display for styles, from which you can select the desired style. After selecting the style, press the [EXIT] button to return to this display, then select the desired sections and channels to be copied.

Determines the playback setting for each channel. You can assemble the accompaniment style while the style section and channel that will be copied are playing.

- **SOLO**
Mutes all but the selected channel. Any parts (channels) set to ON in the RECORD pop-up window on the BASIC page are played back simultaneously.
- **ON**
Plays back the selected part (channel). Any parts (channels) set to ON in the RECORD pop-up window on the BASIC page are played back simultaneously.
- **OFF**
Mutes the selected part (channel).

CAUTION

After you've finished creating/editing a style, make sure to execute the Save operation. The recorded style will be lost if you change to another style or you turn the power off without executing the save operation (page 75).

Groove and Dynamics

The explanations here apply to when you call up the GROOVE page in step #4 of the Basic Procedure on page 161. These versatile features give you a wide variety of tools for changing the rhythmic feel of your created style.

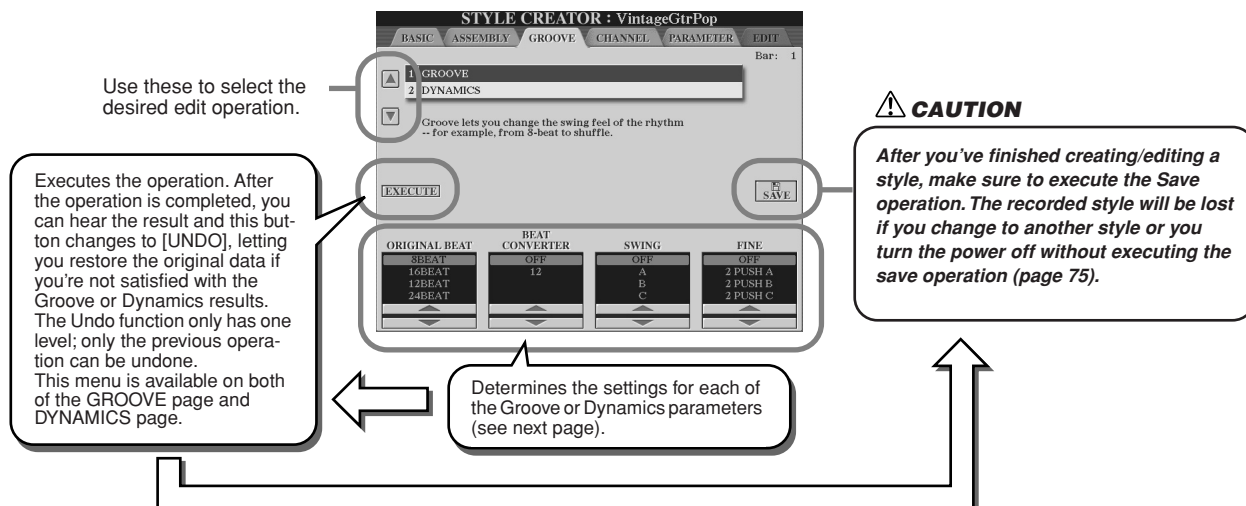

Use these to select the desired edit operation.

Executes the operation. After the operation is completed, you can hear the result and this button changes to [UNDO], letting you restore the original data if you're not satisfied with the Groove or Dynamics results. The Undo function only has one level; only the previous operation can be undone. This menu is available on both of the GROOVE page and DYNAMICS page.

Determines the settings for each of the Groove or Dynamics parameters (see next page).

CAUTION

After you've finished creating/editing a style, make sure to execute the Save operation. The recorded style will be lost if you change to another style or you turn the power off without executing the save operation (page 75).

■ Groove

This lets you add swing to the music or change the “feel” of the beat by making subtle shifts in the timing (clock) of the style. The Groove settings are applied to all parts of the selected style.

ORIGINAL BEAT	Specifies the beats to which Groove timing is to be applied. In other words, if “8 Beat” is selected, Groove timing is applied to the 8th notes; if “12 Beat” is selected, Groove timing is applied to 8th-note triplets.
BEAT CONVERTER	Actually changes the timing of the beats (specified in the ORIGINAL BEAT parameter above) to the selected value. For example, when ORIGINAL BEAT is set to “8 Beat” and BEAT CONVERTER is set to “12,” all 8th notes in the section are shifted to 8th-note triplet timing. The “16A” and “16B” Beat Converter which appear when ORIGINAL BEAT is set to “12 Beat” are variations on a basic 16th-note setting.
SWING	Produces a “swing” feel by shifting the timing of the back beats, depending on the ORIGINAL BEAT parameter above. For example, if the specified ORIGINAL BEAT value is “8 Beat”, the Swing parameter will selectively delay the 2nd, 4th, 6th, and 8th beats of each measure to create a swing feel. The settings “A” through “E” produce different degrees of swing, with “A” being the most subtle and “E” being the most pronounced.
FINE	Selects a variety of Groove “templates” to be applied to the selected section. The “PUSH” settings cause certain beats to be played early, while “HEAVY” settings delay the timing of certain beats. The numbered settings (2, 3, 4, 5) determine which beats are to be affected. All beats up to the specified beat—but not including the first beat—will be played early or delayed (for example, the 2nd and 3rd beats, if “3” is selected). In all cases, “A” types produce minimum effect, “B” types produce medium effect, and “C” types produce maximum effect.

■ Dynamics

This changes the velocity/volume (or accent) of certain notes in the style playback. The Dynamics settings are applied to each part (channel) or all parts (channels) of the selected style.

CHANNEL	Selects the desired channel (part) to which Dynamics is to be applied.
ACCENT TYPE	Determines the type of accent applied—in other words, which notes in the part(s) are emphasized with the Dynamics settings.
STRENGTH	Determines how strongly the selected Accent Type (above) will be applied. The higher the value, the stronger the effect.
EXPAND/COMP.	Expands or compresses the range of velocity values. Values higher than 100% expand the dynamic range, while values lower than 100% compress it.
BOOST/CUT	Boosts or cuts all velocity values in the selected section/channel. Values above 100% boost the overall velocity, while values below 100% reduce it.

Editing Data for each Channel

The explanations here apply when you call up the CHANNEL page in step #4 of the Basic Procedure on page 161.

► **1** Use these to select the desired edit operation.

► **4** Executes the selected operation on the respective page. After the operation is completed, you can hear the result and this button changes to [UNDO], letting you restore the original data if you're not satisfied with the result of each operation. The Undo function only has one level; only the previous operation can be undone.

► **2** Select a channel (part) of which data edit is to be executed.

► **3** Set the parameters for executing the data edit.

► **5** **CAUTION**
After you've finished creating/editing a style, make sure to execute the Save operation. The recorded style will be lost if you change to another style or you turn the power off without executing the save operation (page 75).

QUANTIZE	Same as in the Song Creator. See page 123.
VELOCITY CHANGE	Boosts or cuts the velocity of all notes in the specified channel, according to the percentage specified here.
BAR COPY	This function allows data to be copied from one measure or group of measures to another location within the specified channel. SOURCE specifies the first (TOP) and last (LAST) measures in the region to be copied. DEST specifies the first measure of the destination location, to which the data is to be copied.
BAR CLEAR	This function clears all data from the specified range of measures within the selected channel.
REMOVE EVENT	This function lets you remove specific events from the selected channel.

Making Style File Format Settings

The explanations here apply when you call up the PARAMETER page in step #4 of the Basic Procedure on page 161. This display provides a variety of style controls—such as determining how the pitch and sound of the recorded style change when playing the chords in the left-hand range of the keyboard. Parameter settings on this display are available only when any of the non-rhythm parts are set to “REC” on the RECORD pop-up window on the BASIC page. For details about the relationship between the parameters, refer to “Style File Format” on page 160.

► **1** Use these to select the desired edit operation.

► **4** **CAUTION**
After you've finished creating/editing a style, make sure to execute the Save operation. The recorded style will be lost if you change to another style or you turn the power off without executing the save operation (page 75).

► **2** Select the desired channel (part) to be edited.

► **3** Set the parameters of the channel specified at left.

NOTE

- When NTR is set to “Root Fixed” and NTT is set to “Bypass,” the “Source Root” and “Source Chord” parameters are changed to “Play Root” and “Play Chord,” respectively. In this case, you can change chords and hear the resulting sound for all channels.

NOTE

- Normally in the Style Creator, you can hear your original style-in-process with the Source Pattern. However, there is a way to hear it played by a specific chord and root. To do this, set NTR to “Root Fixed” and NTT to “Bypass,” then change the newly displayed “Play Root” and “Play Chord” parameters to the desired settings.

● **SOURCE ROOT/CHORD**

These settings determine the original key of the source pattern (i.e., the key used when recording the pattern). The default setting of CM7 (with a Source Root of “C” and a Source Type of “M7”), is automatically selected whenever the preset data is deleted prior to recording a new style, regardless of the Source Root and Chord included in the preset data. When you change Source Root / Chord from the default CM7 to another chord, the chord notes and recommended notes will also change, depending on the newly selected chord type.

When the Source Root C:

C = Chord notes
C, R = Recommended notes

● **NTR (Note Transposition Rule)**

This determines the relative position of the root note in the chord, when converted from the Source Pattern in response to chord changes.

<p>ROOT TRANS (Root Transpose)</p>	<p>When the root note is transposed, the pitch relationship between notes is maintained. For example, the notes C3, E3 and G3 in the key of C become F3, A3 and C4 when they are transposed to F. Use this setting for channels that contain melody lines.</p>	<p>When playing a C major chord. → When playing an F major chord.</p>
<p>ROOT FIXED (Root Fixed)</p>	<p>The note is kept as close as possible to the previous note range. For example, the notes C3, E3 and G3 in the key of C become C3, F3 and A3 when they are transposed to F. Use this setting for channels that contain chord parts.</p>	<p>When playing a C major chord. → When playing an F major chord.</p>

● **NTT (Note Transposition Table)**

This sets the note transposition table for the source pattern.

<p>BYPASS</p>	<p>No transposition. The part (channel) of which the NTT is set to this is played back without note conversion even if you change the chord during style playback.</p>
<p>MELODY</p>	<p>Suitable for melody line transposition. Use this for melody channels such as Phrase 1 and Phrase 2.</p>
<p>CHORD</p>	<p>Suitable for chord transposition. Use this for the Chord 1 and Chord 2 channels, especially when they contain piano or guitar-like chordal parts.</p>
<p>MELODIC MINOR</p>	<p>When the played chord changes from a major to a minor chord, this table lowers the third interval in the scale by a semitone. When the chord changes from a minor to a major chord, the minor third interval is raised by a semitone. Other notes are not changed. Use this for melody channels of Sections which respond only to major/minor chords, such as Intros and Endings.</p>
<p>MELODIC MINOR 5th Var.</p>	<p>In addition to the Melodic Minor transposition above, augmented and diminished chords affect the 5th note of the Source Pattern.</p>
<p>HARMONIC MINOR</p>	<p>When the played chord changes from a major to a minor chord, this table lowers the third and sixth intervals in the scale by a semitone. When the chord changes from a minor to a major chord, the minor third and flatted sixth intervals are raised by a semitone. Other notes are not changed. Use this for chord channels of Sections which respond only to major/minor chords, such as Intros and Endings.</p>
<p>HARMONIC MINOR 5th Var.</p>	<p>In addition to the Harmonic Minor transposition above, augmented and diminished chords affect the 5th note of the Source pattern.</p>
<p>NATURAL MINOR</p>	<p>When the played chord changes from a major to a minor chord, this table lowers the third, sixth and seventh intervals in the scale by a semitone. When the chord changes from a minor to a major chord, the minor third, flatted sixth and flatted seventh intervals are raised by a semitone. Other notes are not changed. Use this for chord channels of Sections which respond only to a Major/minor chord such as Intros and Endings.</p>
<p>NATURAL MINOR 5th Var.</p>	<p>In addition to the Natural Minor transposition above, augmented and diminished chords affect the 5th note of the Source pattern.</p>
<p>DORIAN</p>	<p>When the played chord changes from a major to a minor chord, this table lowers the third and seventh intervals in the scale by a semitone. When the chord changes from a minor to a major chord, the minor third and flatted seventh intervals are raised by a semitone. Other notes are not changed. Use this for chord channels of Sections which respond only to a Major/minor chord such as Intros and Endings.</p>
<p>DORIAN 5th Var.</p>	<p>In addition to the Dorian transposition above, augmented and diminished chords.</p>

● **NTT BASS ON/OFF**

The part (channel) for which this parameter is set to on recognizes on-bass chords allowed in the FINGERED ON BASS fingering mode, regardless of the NTT setting.

● HIGH KEY

This sets the highest key (upper octave limit) of the note transposition for the chord root change. Any notes calculated to be higher than the highest key are transposed down to the next lowest octave. This setting is available only when the NTR parameter (page 166) is set to “Root Trans.”

Example—When the highest key is F.

Root changes	➔	CM	C#M	...	FM	F#M	...
Notes played	➔	C3-E3-G3	C#3-F3-G#3		F3-A3-C4	F#2-A#2-C#3	

● NOTE LIMIT

This sets the note range (highest and lowest notes) for voices recorded to the style channels. By judicious setting of this range, you can ensure that the voices sound as realistic as possible—in other words, that no notes outside the natural range are sounded (e.g., high bass sounds or low piccolo sounds). The actual notes that sound are automatically shifted to the set range.

Example—When the lowest note is C3 and the highest is D4.

Root changes	➔	CM	C#M	...	FM	...
Notes played	➔	E3-G3-C4	F3-G#3-C#4		F3-A3-C4	

● RTR

These settings determine whether notes stop sounding or not and how they change pitch in response to chord changes.

STOP	The notes stop sounding.
PITCH SHIFT	The pitch of the note will bend without a new attack to match the type of the new chord.
PITCH SHIFT TO ROOT	The pitch of the note will bend without a new attack to match the root of the new chord.
RETRIGGER	The note is retriggered with a new attack at a new pitch corresponding to the next chord.
RETRIGGER TO ROOT	The note is retriggered with a new attack at the root note of the next chord. However, the octave of the new note remains the same.

Custom Style Recording via an External Sequence Recorder

If you have a favorite sequencer or sequence software, you can use that to create custom styles, instead of using the Style Creator on the Tyros2.

■ Connections.....

- Connect the Tyros2 MIDI OUT to the sequencer MIDI IN, and the sequencer MIDI OUT to the Tyros2 MIDI IN.
- Make sure that the sequencer “ECHO” function is ON, and the Tyros2 LOCAL ON/OFF (page 215) is turned OFF.

■ Creating the Data.....

- Record all sections and parts (channels) using a CM7 (C major seventh) chord.
- Record the parts on the MIDI channels listed at right, using the Tyros2’s internal tone generator. If the Tyros2 is not used during recording, make sure to use XG voices on an XG- and SFF- (Style File Format) compatible tone generator for optimum results.
- Record the sections in the order listed below, with a Marker Meta-event at the top of each section. Enter the Marker Meta-events exactly as indicated in the chart on the next page (including upper/ lower case characters and spaces).
- Also include an “SFF1” Marker Meta-event, “SInt” Marker Meta-event and style name Meta-event at 1111000 (the top of the sequence track), and the GM on Sys/Ex message (F0, 7E, 7F, 09, 01, F7). (“Timing” in the chart is based on 480 clocks per quarter note. “1111000” is clock “0” of the first beat of the first measure).
- The data from 1111000 through 1141479 is the “Initial Setup,” and 2111000 through the end of Ending B is the “Source Pattern.”
- The timing of Fill In AA and subsequent Marker Meta-events will depend on the length of each section.

Part	MIDI Ch.
Rhythm1	9
Rhythm2	10
Bass	11
Chord1	12
Chord2	13
Pad	14
Phrase1	15
Phrase2	16

NOTE

- Explanations here assume a sequencer resolution of 480 clocks per quarter note. The actual clock values here may differ depending on your sequencer.

Style Creator (Digital Recording)

- The Initial Setup area from 1|2|000 through 1|4|479 is used for voice and effect settings. Do not include note event data.
- The Main A data begins at 2|1|000. Any number of measures from 1 to 255 can be used.
- Fill In AA begins from the top of the measure following the last measure of the Main A pattern. In the chart this is 4|1|00, but this is only an example and the actual timing will depend on the length of Main A. Please note that all Fill Ins can be only 1 measure in length (refer to the Section/Length chart below).

Section	Length
Intro	255 measures max.
Main	255 measures max.
Fill In	1 measure
Ending	255 measures max.

The following charts indicate the valid MIDI events for both the Initial Setup data and the Pattern data. Make sure to NOT enter any events marked with a dash (—), nor any other events not listed here.

Channel Message

Event	Initial Setup	Source Pattern
Note Off	—	OK
Note On	—	OK
Program Change	OK	OK
Pitch Bend	OK	OK
Control #0 (Bank Select MSB)	OK	OK
Control #1 (Modulation)	OK	OK
Control #6 (Data Entry MSB)	OK	—
Control #7 (Master Volume)	OK	OK
Control #10 (Pan)	OK	OK
Control #11 (Expression)	OK	OK
Control #32 (Bank Select LSB)	OK	OK
Control #38 (Data Entry LSB)	OK	—
Control #71 (Harmonic Content)	OK	OK
Control #72 (Release Time)	OK	—
Control #73 (Attack Time)	OK	—
Control #74 (Brightness)	OK	OK
Control #84 (Portamento Control)	—	OK
Control #91 (Reverb Send Level)	OK	OK
Control #93 (Chorus Send Level)	OK	OK
Control #94 (Variation Send Level)	OK	OK
Control #98 (NRPN LSB)	OK	—
Control #99 (NRPN MSB)	OK	—
Control #100 (RPN LSB)	OK	—
Control #101 (RPN MSB)	OK	—

RPN & NRPN

Event	Initial Setup	Source Pattern
RPN (Pitch Bend Sensitivity)	OK	—
RPN (Fine Tuning)	OK	—
RPN (Coarse Tuning)	OK	—
RPN (Null)	OK	—
NRPN (Vibrato Rate)	OK	—
NRPN (Vibrato Delay)	OK	—
NRPN (EG Decay Time)	OK	—
NRPN (Drum Filter Cutoff Frequency)	OK	—
NRPN (Drum Filter Resonance)	OK	—
NRPN (Drum EG Attack Time)	OK	—
NRPN (Drum EG Decay Time)	OK	—
NRPN (Drum Instrument Pitch Coarse)	OK	—
NRPN (Drum Instrument Pitch Fine)	OK	—
NRPN (Drum Instrument Level)	OK	—
NRPN (Drum Instrument Pan)	OK	—
NRPN (Drum Instrument Reverb Send Level)	OK	—
NRPN (Drum Instrument Chorus Send Level)	OK	—
NRPN (Drum Instrument Variation Send Level)	OK	—

● Style Data Format

Timing	Marker Meta-Event	Contents	Comments	
1 1 000 1 1 000	SFF1	Style Name (Sequence/Track Name Meta-Event)	Initial Setup	
1 1 000 1 1 000 1 2 000 ⋮ 1 4 479	SInt	GM on Sys/Ex Initial Setup Events		
2 1 000 3 4 479	Main A	2 bars Main Pattern (up to 255 bars)		Source Pattern
4 1 000 4 4 479	Fill In AA	1 bar Fill In Pattern		
5 1 000 6 4 479	Intro A	2 bars Intro Pattern (up to 255 bars)		
7 1 000 8 4 479	Ending A	2 bars Intro Pattern (up to 255 bars)		
9 1 000 10 4 479	Main B	2 bars Intro Pattern (up to 255 bars)		
11 1 000 11 4 479	Fill In BA	1 bar Fill In Pattern		
12 1 000 12 4 479	Fill In BB	1 bar Fill In Pattern		
13 1 000 14 4 479	Intro B	2 bars Intro Pattern (up to 255 bars)		
15 1 000 16 4 479	Ending B	2 bars Intro Pattern (up to 255 bars)		
17 1 000 18 4 479	Main C	2 bars Main Pattern (up to 255 bars)		
19 1 000 19 4 479	Fill In CC	1 bar Fill In Pattern		
20 1 000 21 4 479	Intro C	2 bars Intro Pattern (up to 255 bars)		
22 1 000 23 4 479	Ending C	2 bars Intro Pattern (up to 255 bars)		
24 1 000 25 4 479	Main D	2 bars Main Pattern (up to 255 bars)		
26 1 000 26 4 479	Fill In DD	1 bar Fill In Pattern		

System Exclusive

Event	Initial Setup	Source Pattern
Sys/Ex GM on	OK	—
Sys/Ex XG on	OK	—
Sys Ex XG Parameter Change (Effect1)	OK	—
Sys Ex XG Parameter Change (Multi Part)	—	—
DRY LEVEL	OK	OK
Sys Ex XG Parameter Change (Drum Setup)	—	—
PITCH COARSE	OK	—
PITCH FINE	OK	—
LEVEL	OK	—
PAN	OK	—
REVERB SEND	OK	—
CHORUS SEND	OK	—
VARIATION SEND	OK	—
FILTER CUTOFF FREQUENCY	OK	—
FILTER RESONANCE	OK	—
EG ATTACK	OK	—
EG DECAY1	OK	—
EG DECAY2	OK	—

The Multi Pads

Quick Guide on page 38 →

Basic information about how to play the Multi Pads is explained in the “Quick Guide.” This section covers how the Multi Pad data is managed on the Open/Save display and how to create (record) Multi Pad data.

Multi Pad Editing using the Open/Save display

Multi Pads are grouped in Banks or four each and handled as files from the Open/Save display.

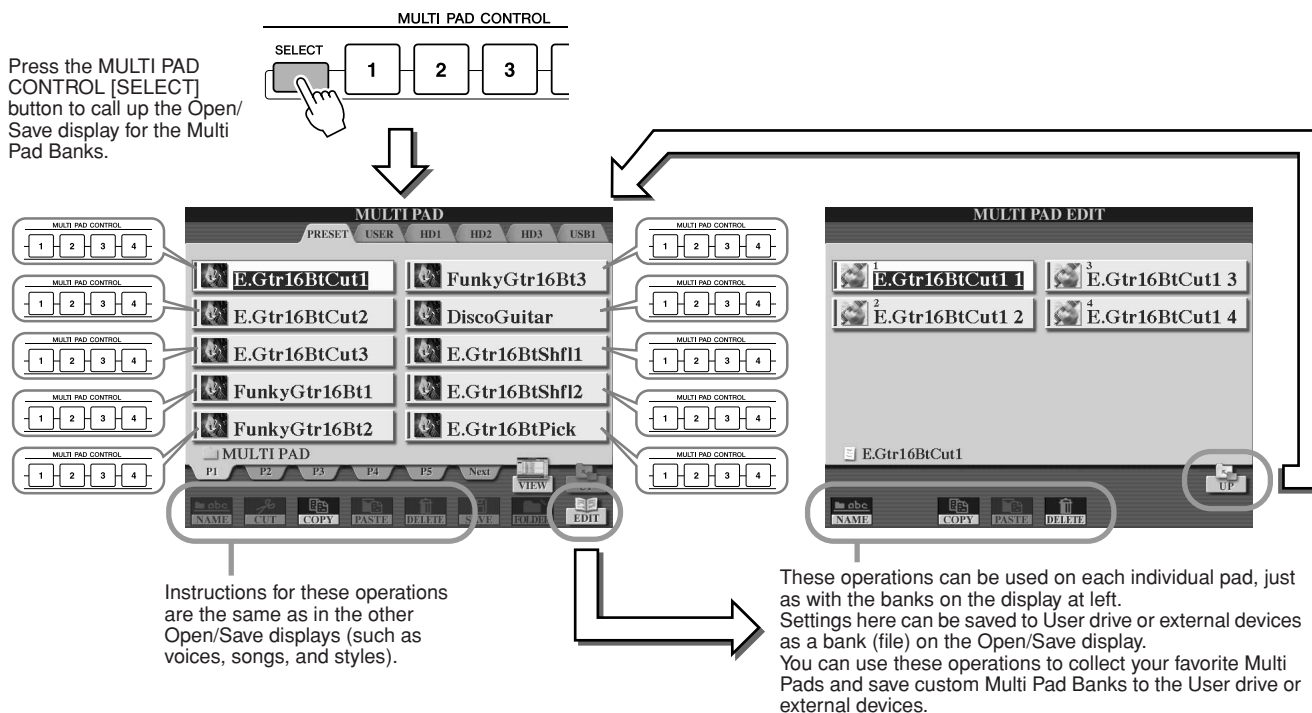

Multi Pad Creating/Editing (Digital Recording)

The Multi Pad Creator lets you create your original Multi Pad phrases.

Basic Procedure (Multi Pad Creator)

- 1 Select a Multi Pad Bank to be edited or created from the Open/Save display.
- 2 Press the [DIGITAL RECORDING] button.
- 3 Select “MULTI PAD CREATOR.”

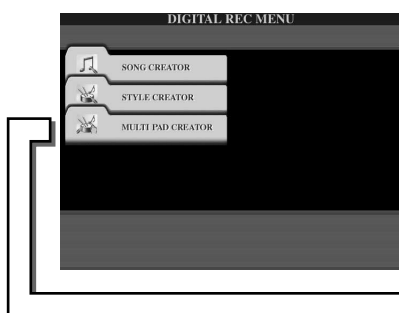

The operations corresponding to step #4 are covered in the following page.

- 4 Create the Multi Pad data.

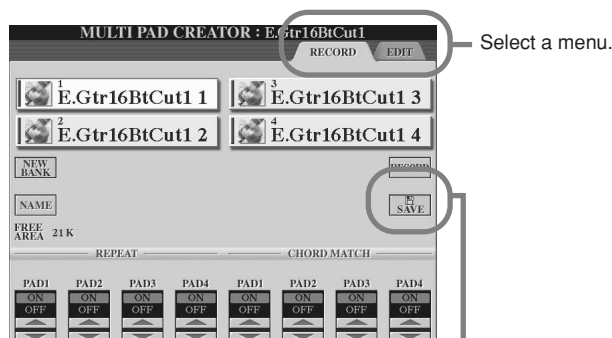

CAUTION

After you've finished creating/editing a Multi Pad, make sure to execute the Save operation. The recorded Multi Pad will be lost if you change to another bank or you turn the power off without executing the save operation (page 75).

Multi Pad Realtime Recording

The explanations here apply when you call up the RECORD page in step #4 of the Basic Procedure on page 169.

- 1** Select a particular Multi Pad for recording. If you want to create the Multi Pad data from scratch, press the [NEW BANK] LCD button to call up an empty bank.

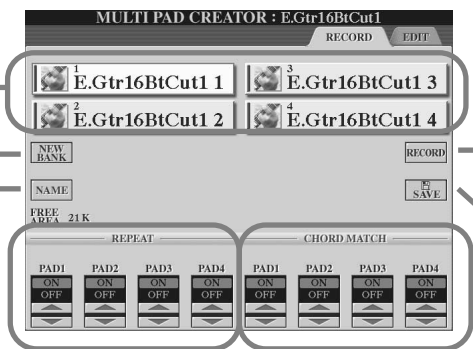

- 2** Execute the Realtime Recording.
- 3** Turn Repeat of each pad On or Off.
- 4** Turn Chord Match of each pad On or Off.
- 5** Enter a name for each Multi Pad, as desired.

2 Execute the Realtime Recording.

6 After you've finished creating/editing a Multi Pad, make sure to execute the Save operation (page 75).

Start recording

Press the [RECORD] LCD button to enable Synchro Start. Recording begins automatically as soon as you play on the keyboard.

You can also start recording by pressing the STYLE CONTROL [START/STOP] button. This lets you record as much silence as you want before the start of the Multi Pad phrase.

If Chord Match is set to on for the Multi Pad to be recorded, you should record using the notes of the C major seventh scale (C, D, E, G, A and B).



C = Chord note
C, R = Recommended note

Stop recording

Press the [STOP] LCD button or the panel MULTI PAD CONTROL [STOP] button to stop recording when you've finished playing the phrase.

Repeat On/Off

If the Repeat parameter is on for the selected pad, playback of the corresponding pad will continue until the MULTI PAD [STOP] button is pressed. When you press the Multi Pads of which the Repeat is turned on during song or style playback, playback will start and repeat in sync with the beat.

If the Repeat parameter is off for the selected pad, playback will end automatically as soon as the end of the phrase is reached.

Chord Match On/Off

If the Chord Match parameter is on for the selected pad, the corresponding pad is played back according to the chord specified in the chord section of the keyboard generated by turning [ACMP] on, or specified in the LEFT voice section of the keyboard generated by turning [LEFT] on (when turning the [ACMP] off).

Multi Pad Step Recording using the Event List

The explanations here apply to when you call up the EDIT page in step #4 of the Basic Procedure on page 169. The EDIT page indicates the Event list that lets you record notes with absolutely precise timing. This Step Recording procedure is essentially the same as that for Song Recording (pages 127–132), with the exception of the points listed below:

- There is no LCD button for switching channels, since Multi Pads contain data for only a single channel.
- In the Multi Pad Creator, only the channel events and System Exclusive messages can be entered. Chord and Lyrics events are not available. You can switch between the two types of Event Lists by pressing the [F] button.

NOTE

- Multi Pads indicated with the following icon (hand on fretboard) are created with special note transpositions to produce the natural chord voicing of the guitar. Because of this, if the Chord Match setting is set to off, the Multi Pads may not sound appropriately.



Music Finder

Quick Guide on page 40 ➔

This section briefly shows how to create and edit Music Finder records, and gives information about the structure and organization of Music Finder data. For basic instructions on using Music Finder, see the “Quick Guide.”

Music Finder Record Editing

From the [MUSIC FINDER] → RECORD EDIT display, you can call up existing records and edit them to suit your preferences. You can even use this to create your own Music Finder records which are saved to internal Flash ROM automatically.

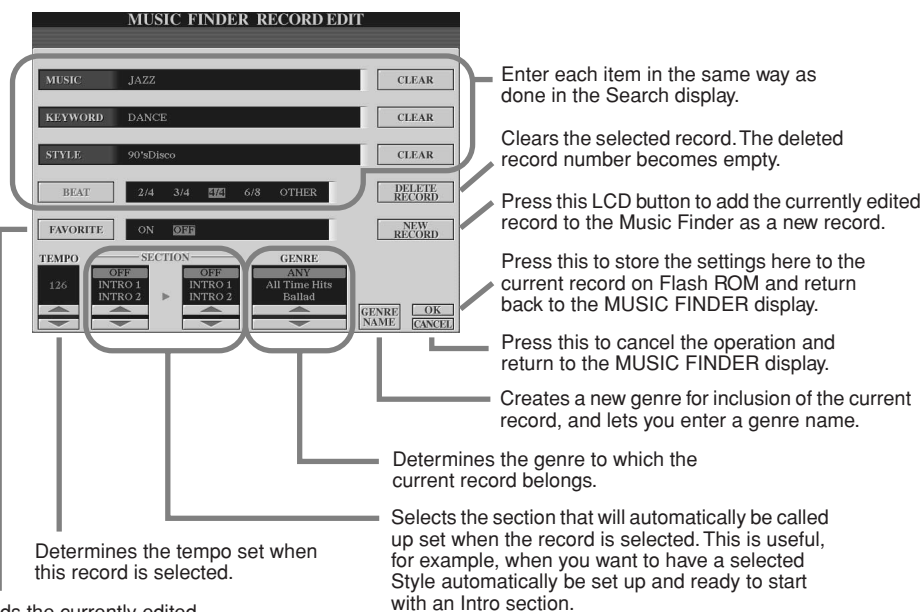

NOTE

- You can also change a preset record to create a new one. If you want to keep the original preset, make sure to name and register the edited record as a new record. Preset records can also be cleared.
- Keep in mind that the Beat setting made here is only for the Music Finder search function; this does not affect the actual Beat setting of the style itself.
- The maximum number of records is 2500, including preset records.

Saving Music Finder Records as a single file

All Music Finder records created and stored on the internal Flash ROM can be handled together as a single file. Keep in mind that individual records (panel setups) cannot be handled as separate files.

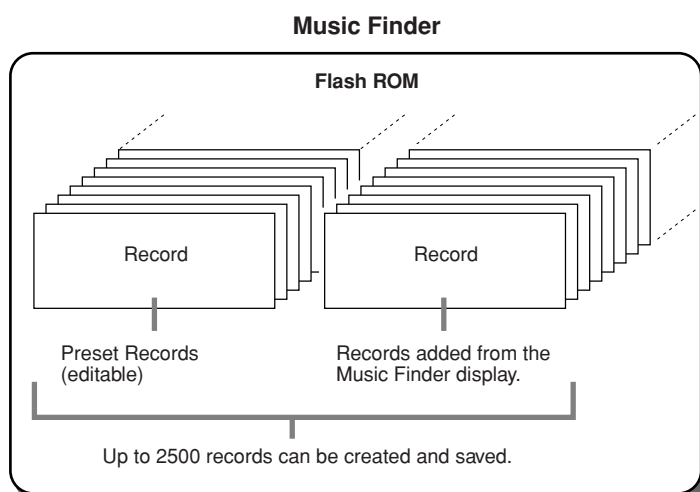

The Open/Save display for the Music Finder called up via [FUNCTION] → UTILITY → SYSTEM RESET → MUSIC FINDER lets you save the Music Finder file to the User drive or external devices.

All records can be saved together as a single file.

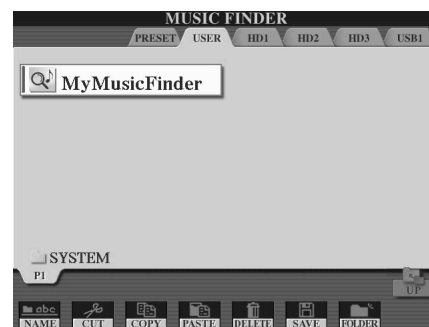

Restoring the Factory-programmed Music Finder.....

The operation below lets you restore the Tyros2's Music Finder to its original factory settings.

1 Press the [FUNCTION] button.

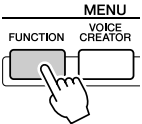

2 Select "UTILITY."

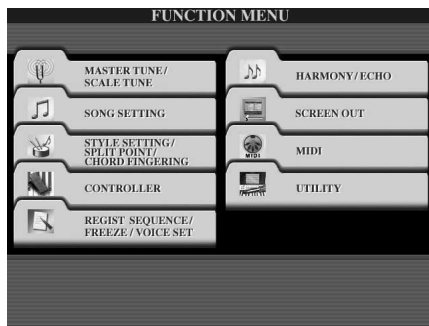

3 Checkmark the MUSIC FINDER box.

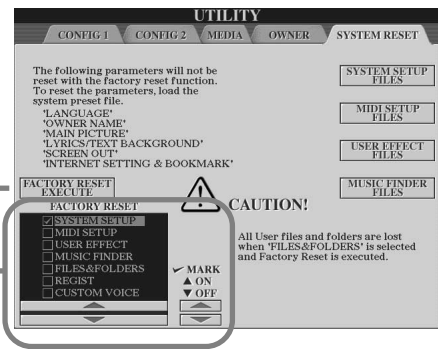

4 Executes the Factory Reset operation for the Music Finder.

CAUTION!
All User files and folders are lost when "FILES&FOLDERS" is selected and Factory Reset is executed.

CAUTION
This operation automatically deletes all your original records from internal memory and replaces them with the factory Music Finder data.

Calling up Music Finder files saved to User drive or external devices

You can call up Music Finder data saved to any of the installed drives by the following procedure.

Call up the Open/Save display for the Music Finder via [FUNCTION] → UTILITY → SYSTEM RESET → MUSIC FINDER.

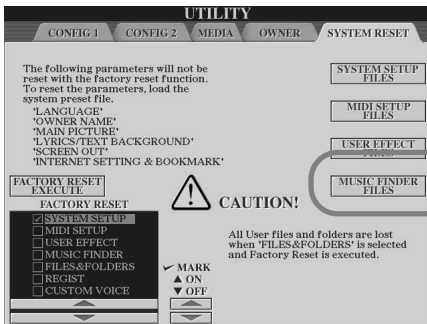

Select the desired Music Finder file from the User drive or external devices.

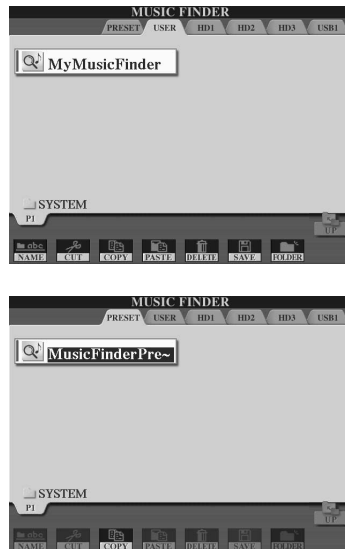

All Music Finder records can be stored together as a single file. When selecting a stored file, a message appears prompting you to replace or append the records as desired.

REPLACE
All Music Finder records currently in the instrument are deleted and replaced with the records of the selected file.

APPEND
The records called up are added to the vacant record numbers.

Select one of the settings above to call up the Music Finder file. Select "CANCEL" to abort this operation.

You can select a Music Finder file from the Preset drive. This file is the factory-programmed Music Finder.

CAUTION
Selecting "REPLACE" automatically deletes all your original records from internal memory and replaces them with the factory Music Finder data.

Registration Memory

Quick Guide on page 52 ➔

Basic instructions on using the Registration Memory are explained in the “Quick Guide.” This section gives detailed information on the Freeze and Registration Sequence functions not covered in the “Quick Guide.”

■ About User Voices and Registration Memory

When you memorize a panel setup to Registration Memory that uses a User voice (on the User drive or external devices), keep in mind that the actual User voice is not memorized to Registration Memory—only its settings are.

Registration Memory saves and recognizes a User voice as:

- The preset voice on which the User voice is based
- The parameter settings made in Voice Set

Selecting a Registration Memory number with User voice calls up the two above, and not the User voice on the drive. This means that the actual User voice could be changed or even deleted from the drive, and yet still be available in Registration Memory.

Freeze

Quick Guide on page 54 ➔

This section briefly covers details on the Freeze function. For basic instructions on Freeze, refer to the “Quick Guide.”

- ▶ **1** Call up the Registration Freeze display via [FUNCTION] → FREEZE and select the parameter group to be “frozen” or unchanged.

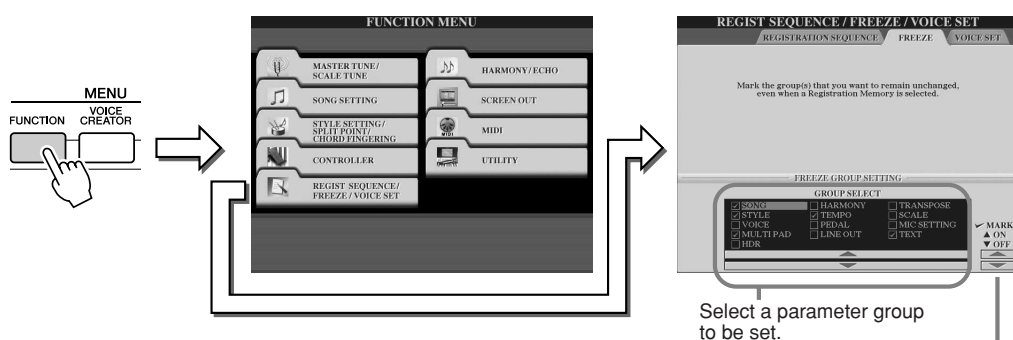

⚠ CAUTION

Settings in the Registration Freeze display are automatically saved to Flash ROM when you exit from the display. However, if you turn the power off without exiting from this display, the settings will be lost.

📖 NOTE

- The settings on the Registration Freeze display can be saved to the User drive or external devices on the [FUNCTION] → UTILITY → SYSTEM SETUP display as a System Setup file (page 196).

These enter and remove checkmarks from the parameter groups. If you want a parameter group to remain unchanged even when changing Registration Memory numbers, enter a checkmark to the appropriate box.

- ▶ **2** Turn the [FREEZE] button on.
- ▶ **3** You can check whether your Freeze settings are correct or not by changing the Registration Memory number.



Registration Sequence

As convenient as the Registration Memory buttons are, there may be times during a performance when you want to quickly switch between settings—without having to take your hands from the keyboard. The convenient Registration Sequence function lets you call up the presets in any order you specify, by simply using the [TAB] buttons or the pedal as you play.

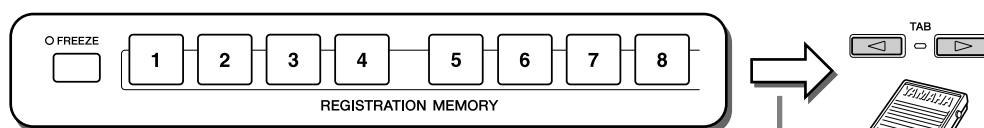

Two functions—changing a Bank according to the order listed on the Open/Save display and changing the Memory number according to the order determined from the Registration Sequence display—can be assigned to the [TAB] button and the foot pedal connected to the Tyros2.

- ▶ **1** Select a Registration Memory bank of which the sequence is programmed.
- ▶ **2** Call up the Registration Sequence display via [FUNCTION] → REGISTRATION SEQUENCE.

▶ 3 Program the Registration Sequence.

Determines which pedal is used to reverse (decrement) through the sequence.

Determines which pedal is used to advance (increment) through the sequence.

Indicates the file name of the selected Registration Memory bank.

Turns the Registration Sequence function on/off. When this is set to "ON," the programmed Registration Sequence is shown at the top right of the Main display, and you can step through the sequence in this display by using the [TAB] buttons or the pedal.

Indicates the Registration Memory preset numbers, in the order of the current Registration Sequence.

Deletes all Registration Memory numbers in the sequence.

Deletes the number at the cursor position.

Inserts the number of the currently selected Registration Memory preset immediately before the cursor position.

Replaces the number at the cursor position with the currently selected Registration Memory number.

These move the cursor position in the sequence.

The controls in this section are used for specifying the order for calling up Registration Memory number as a Registration Sequence.

NOTE

- When both "Regist (+) Pedal" and "Regist (-) Pedal" are set to "OFF," the pedals cannot be used to step through the Registration Sequence; only the [TAB] buttons can be used in the MAIN display.

CAUTION

Registration Sequence data is included as part of the Registration Memory bank file. To store your newly programmed Registration Sequence, save the current Registration Memory bank file (in step #5 below). Any Registration Sequence data is lost when changing Registration Memory banks or when turning the power off, unless you've saved it with the Registration Memory bank file.

Determines how Registration Sequence behaves when reaching the end of the sequence.

- STOP** Pressing the [TAB] button or the "advance" pedal has no effect. The sequence is "stopped."
- TOP** The sequence starts again at the beginning.
- NEXTBANK** The sequence automatically moves to the beginning of the next Registration Memory bank in the same folder.

▶ 4 After setting the REGISTRATION SEQUENCE ENABLE to on, press the [EXIT] button to return to the Main display and confirm whether the Registration Memory numbers are called up according to the sequence programmed above.

- Use the [TAB] button to call up the Registration Memory numbers in the order of the sequence, or use the [TAB] button to call them up in reverse order. The [TAB] buttons can only be used for Registration Sequence when the Main display is called up.
- Use a connected foot pedal to select the Registration Memory numbers in order. The foot pedal can be used for Registration Sequence no matter which display is called up (except for the display in step #3 above).

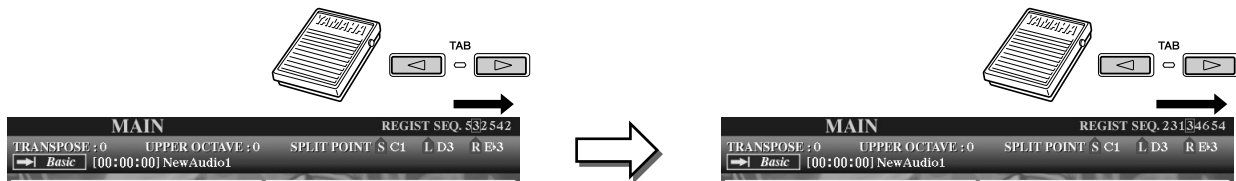

The Registration Sequence is indicated at the top of the Main display, letting you confirm the currently selected number.

When the SEQUENCE END is set to "NEXT BANK," the sequence automatically moves to the beginning of the next Registration Memory bank in the same folder.



NOTE

- To return to the first sequence in one action, press the [TAB] buttons simultaneously in the Main display. This cancels the currently selected sequence number (the box indicator at the top right goes out). The first sequence will be selected by pressing one of the [TAB] buttons or by pressing the pedal.

▶ 5 Call up the Open/Save display for the Registration Memory Bank and save the Registration Sequence setting as a Registration Memory Bank file.

Using a Microphone

Quick Guide on page 47 ➔

Connect a microphone to the Tyros2 and take advantage of the following features:

- **Song Score and Lyrics display (pages 112, 114)**—for ease in following along with a song.
- **Guide (page 49)**—for practicing your singing and learning the proper pitches.
- **Vocal Harmony (page 48)**—for automatically adding harmony vocals to your voice.
- **Talk (page 177)**—for instantly changing the microphone settings, or for making announcements between songs.

You can also apply DSP effects to your voice or make other microphone-related settings from the Mixing Console display (page 179).

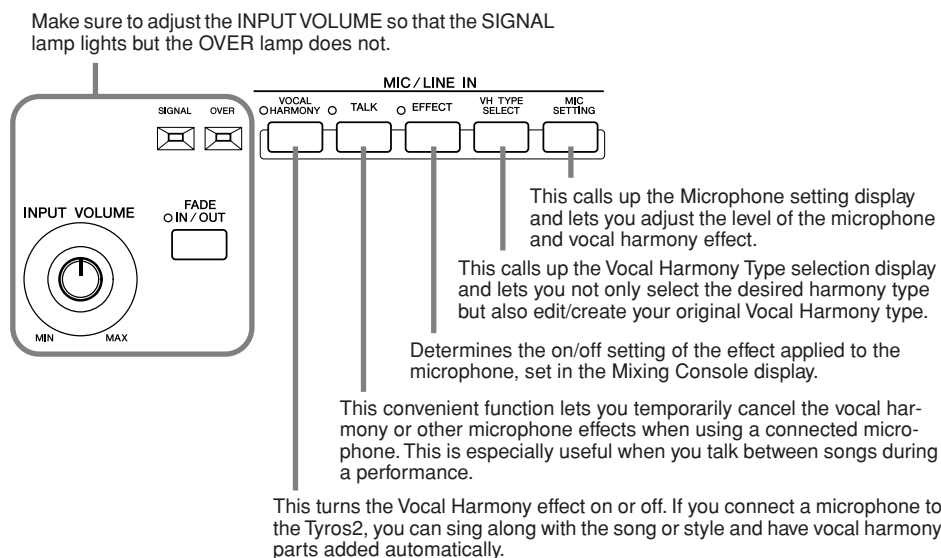

Vocal Harmony Edit

This section explains briefly how to create your own Vocal Harmony types, and lists the detailed parameters for editing. Up to ten Vocal Harmony types can be created and saved. For basic instructions on using Vocal Harmony, refer to the “Quick Guide.”

CAUTION

The settings here will be lost if you change to another Vocal Harmony type or you turn the power off without executing the save operation.

1

Press the [VH TYPE SELECT] button.

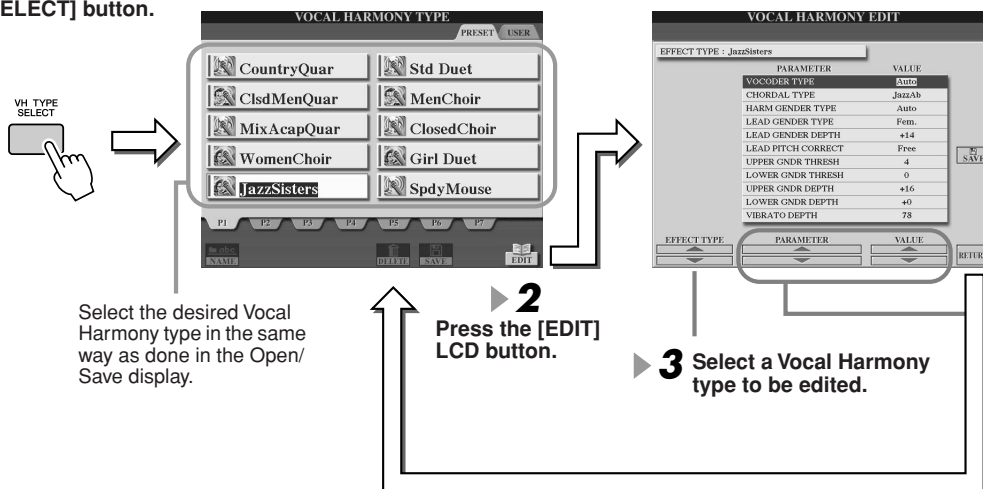

Vocal Harmony Edit parameters

VOCODER TYPE	Determines how the harmony notes are applied to the microphone sound when the Harmony mode (page 178) is set to “VOCODER.”
CHORDAL TYPE	Determines how the harmony notes are applied to the microphone sound when the Harmony mode (page 178) is set to “CHORDAL.”

HARMONY GENDER TYPE	Determines whether the gender of the harmony sound is changed or not. Off The gender of the harmony sound is not changed. Auto The gender of the harmony sound is changed automatically.
LEAD GENDER TYPE	Determines whether and how the gender of the lead vocal sound (i.e., the direct microphone sound) will be changed. Please note that the number of harmony notes differs depending on the selected type. When set to Off, three harmony notes are produced. Other settings produce two harmony notes. Off No gender change occurs. Unison No gender change occurs. You can adjust the LEAD GENDER DEPTH below. Male The corresponding gender change is applied to the lead vocal. Female The corresponding gender change is applied to the lead vocal.
LEAD GENDER DEPTH	Adjusts the degree of lead vocal gender change. This is available when the LEAD GENDER TYPE above is set to other than Off. The higher the value, the more “feminine” the harmony voice becomes. The lower the value, the more “masculine” the voice.
LEAD PITCH CORRECT	This parameter is only effective when the LEAD GENDER TYPE above is set to other than Off. When Smooth or Hard is selected, the pitch of the lead vocal is shifted in precise semitone steps.
UPPER GENDER THRESHOLD	Gender change will occur when the harmony pitch reaches or exceeds the specified number of semitones above the lead vocal pitch.
LOWER GENDER THRESHOLD	Gender change will occur when the harmony pitch reaches or exceeds the specified number of semitones below the lead vocal pitch.
UPPER GENDER DEPTH	Adjusts the degree of gender change applied to harmony notes higher than the UPPER GENDER THRESHOLD. The higher the value, the more “feminine” the harmony voice becomes. The lower the value, the more “masculine” the voice.
LOWER GENDER DEPTH	Adjusts the degree of gender change applied to harmony notes lower than the LOWER GENDER THRESHOLD. The higher the value, the more “feminine” the harmony voice becomes. The lower the value, the more “masculine” the voice.
VIBRATO DEPTH	Sets the depth of vibrato applied to the harmony sound. Also affects the lead vocal sound when the LEAD GENDER TYPE above is set to other than Off.
VIBRATO RATE	Sets the speed of the vibrato effect. Also affects the lead vocal sound when the LEAD GENDER TYPE above is set to other than Off.
VIBRATO DELAY	Specifies the length of the delay before the vibrato effect begins when a note is produced. Higher values result in a longer delay.
HARMONY1/2/3 VOLUME	Sets the volume of the first/second/third harmony note.
HARMONY1/2/3 PAN	Specifies the stereo (pan) position of the first/second/third harmony note. Random The stereo position of the sound will change randomly whenever the keyboard is played. -63-0-+63 A setting of -63 pans the sound hard left, while 0 is at center, and +63 is at hard right.
HARMONY1/2/3 DETUNE	Detunes the first/second/third harmony note by the specified number of cents.
PITCH TO NOTE	When this is set to “ON,” you can “play” the voices of the Tyros2 with your voice. (The Tyros2 tracks the pitch of your voice and converts it to note data for the tone generator. Keep in mind, however, that dynamic changes in your voice do not affect the volume of the tone generator.)
PITCH TO NOTE PART	Determines which of the Tyros2 parts will be controlled by the lead vocal when the Pitch to Note parameter is “ON.”

Talk Setting

This function is ideal for making announcements between your singing performances. When singing a song, several effects such as reverb, delay and vocal harmony are usually assigned to the MIC/LINE IN Setup. When speaking to your audience, however, these effects may sound disturbing or unnatural. Whenever the [TALK] button is turned on, Delay and Vocal Harmony effects turn off and the amount of reverb lowers automatically. Talk settings can be customized as well, allowing you to add any desired effects to your voice as you speak to your audience. Turning the [TALK] button off automatically recalls the MIC/LINE IN Setup for singing again.

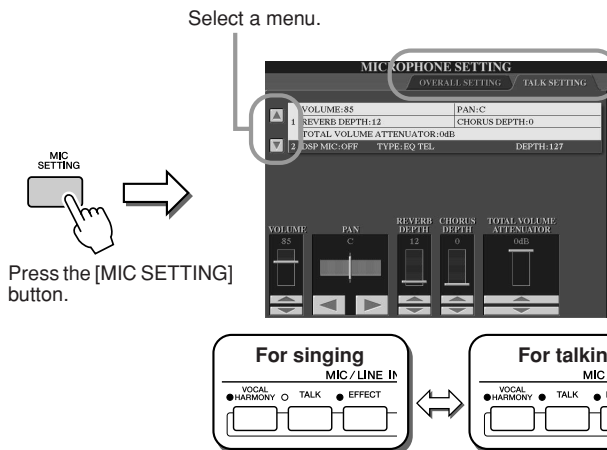

If necessary, use the [TAB] buttons to call up the Talk Setting display.

CAUTION
Settings in the Talk Settings display are automatically saved to Flash ROM when you exit from the display. However, if you turn the power off without exiting from this display, the settings will be lost.

NOTE
• The settings on the Talk Setting display can be saved to the User drive or external devices on the [FUNCTION] → UTILITY → SYSTEM SETUP display as a System Setup file (page 196)

Talk Setting Parameters

VOLUME	This determines the output volume of the microphone sound.
PAN	This sets the stereo pan position of the microphone sound.
REVERB DEPTH	These set the depth of the reverb effects applied to the microphone sound.
CHORUS DEPTH	These set the depth of the chorus effects applied to the microphone sound.
TOTAL VOLUME ATTENUATOR	This determines the amount of attenuation to be applied to the overall sound (excepting the microphone input)—allowing you to effectively adjust the balance between your voice and the overall instrument sound.
DSP MIC ON/OFF	This turns the DSP effect applied to the microphone sound ON or OFF.
DSP MIC TYPE	This selects the type of DSP effect to be applied to the microphone sound.
DSP MIC DEPTH	This sets the depth of the DSP effect applied to the microphone sound.

Microphone Overall Settings

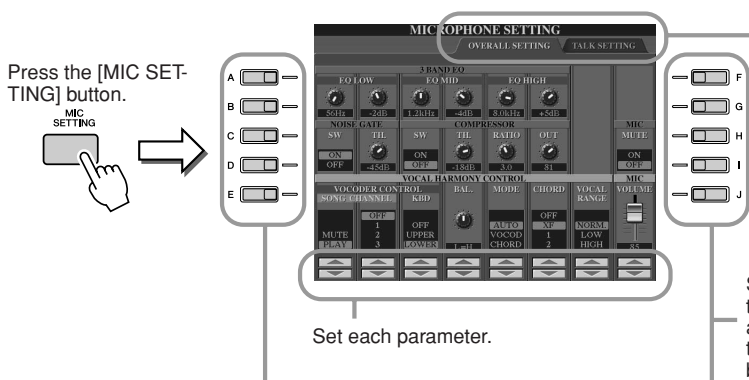

If necessary, press the [TAB] button to call up the Microphone Overall Settings display.

CAUTION
Settings in the Microphone Overall Settings display are automatically saved to Flash ROM when you exit from the display. However, if you turn the power off without exiting from this display, the settings will be lost.

3BAND EQ

EQ (Equalizer) is a processor that divides the frequency spectrum into multiple bands which can be boosted or cut as required to tailor the overall frequency response. The Tyros2 features a high grade three-band digital equalizer function for the microphone sound.

- **Hz** Adjusts the center frequency of the corresponding band.
- **dB** Boosts or cuts the level of the corresponding band by up to 12 dB.

■ NOISE GATE

This effect mutes the input signal when the input from the microphone falls below a specified level. This effectively cuts off extraneous noise, allowing the desired signal (vocal, etc.) to pass.

- **SW (Switch)** This turns Noise Gate on or off.
- **TH. (Threshold)** This adjusts the input level at which the gate begins to open.

■ COMPRESSOR

This effect holds down the output when the input signal from the microphone exceeds a specified level. This is especially useful for smoothing out vocals that have widely varying dynamics. It effectively “compresses” the signal, making soft parts louder and loud parts softer.

- **SW (Switch)** This turns Compressor on or off.
- **TH. (Threshold)** This adjusts the input level at which compression begins to be applied.
- **RATIO** This adjusts the compression ratio.
- **OUT** Adjusts the final output level.

■ VOCAL HARMONY CONTROL

The following parameters determine how the harmony is controlled.

● VOCODER CONTROL

The Vocal Harmony effect is controlled by note data—the notes you play on the keyboard and/or the notes of the song data. This parameter lets you determine which notes are used to control the harmony.

SONG CHANNEL	MUTE/PLAY	When set to “MUTE,” the channel selected below is muted (turned off) during keyboard performance or song playback.
	OFF/1–16	When set to “OFF,” song data control over harmony is turned off. When set to one of the values 1–16, note data (played from a song on disk or external MIDI sequencer) contained on the corresponding channel is used to control the harmony.
KEYBOARD	OFF	Keyboard control over harmony is turned off.
	UPPER	Notes played to the right of the split point (page 158) control the harmony.
	LOWER	Notes played to the left of the split point (page 158) control the harmony.

● BAL (Balance)

This lets you set the balance between the lead vocal (your own voice) and Vocal Harmony. Raising this value increases the volume of the Vocal Harmony and decreases that of the lead vocal. When this is set to L<H63 (L: Lead Vocal, H: Vocal Harmony), only the Vocal Harmony is output; when it is set to L63>H, only the lead vocal is output.

● MODE (Vocal Harmony mode)

All of the Vocal Harmony types fall into one of three modes which produce harmony in different ways. The harmony effect is dependent on the selected Vocal Harmony mode, and this parameter determines how the harmony is applied to your voice. The three modes are described below.

VOCODER	The harmony notes are determined by the notes you play on the keyboard and/ or song data.
CHORDAL	The harmony notes are determined by the following three types of chord: chords played in the chord section of the keyboard (with the [ACMP] turned on), chords played in the LEFT voice section of the keyboard (with the [ACMP] turned off and the [LEFT] turned on), and chords contained in song data for controlling the harmony. (Not available if the song does not contain any chord data.)
AUTO	When the [ACMP] or [LEFT] is set to ON and if chord data exists in the song, the mode is automatically set to CHORDAL. In all other cases, the mode is set to VOCODER.

● CHORD

The following parameters determine which data in a recorded song is used for chord detection.

OFF	Chords are not detected from the song data.
XF	Chords of XF format are used for the Vocal Harmony.
1–16	Chords are detected from note data in the specified song channel.

● Vocal Range

Set this to obtain the most natural vocal harmony, depending on your voice.

Normal	Normal setting
Low	Setting for lower voice. This setting is also appropriate for growling and shouting.
High	Setting for higher voice. This setting is also appropriate for singing close to the microphone.

■ MIC/LINE IN (Microphone)

The following parameters determine how the microphone sound is controlled.

MUTE	When set to OFF, the microphone sound is turned off.
VOLUME	Adjusts the output volume of the microphone sound.

Mixing Console

There are many components that make up the overall sound of the Tyros2. These include MIDI sequence data from the songs, styles, and Multi Pads, and audio input from a microphone, as well as the various parts of your keyboard performance. The Mixing Console gives you control over the volume and pan settings of each of these components—and some other settings as well—letting you fine-tune the overall sound of the Tyros2.

Parts making up the Tyros2 sound

● **Keyboard parts**

Consists of RIGHT 1, RIGHT 2, RIGHT 3, LEFT.

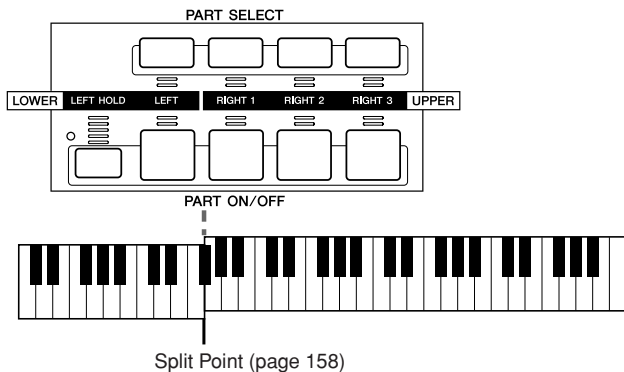

● **Multi Pad parts**

Consists of Multi Pads 1, 2, 3, and 4

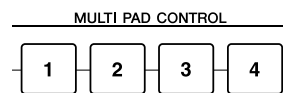

● **Microphone sound part**

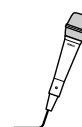

● **Song parts**

Consists of 1–16 channels.

SONG		STYLE		CHANNEL ON / OFF											
1	2	3	4	5	6	7	8	9	10	11	12	13	14	15	16
ON	ON	ON	ON	ON	ON	ON	ON	ON	ON	ON	ON	ON	ON	ON	ON
ON	ON	ON	ON	ON	ON	ON	ON	ON	ON	ON	ON	ON	ON	ON	ON

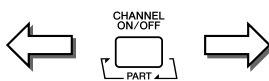

● **Style parts**

Consists of Rhythm 1, 2, Bass, Chord1, 2, Pad, Phrase 1, 2

SONG		STYLE		CHANNEL ON / OFF											
RHY1	RHY2	BASS	CHD1	CHD2	PAD	PHR1	PHR2	1	2	3	4	5	6	7	8
ON	ON	ON	ON	ON	ON	ON	ON	ON	ON	ON	ON	ON	ON	ON	ON
ON	ON	ON	ON	ON	ON	ON	ON	ON	ON	ON	ON	ON	ON	ON	ON

Basic Procedure (Mixing Console)

1 Press the [MIXING CONSOLE] button to call up the Mixing Console display.

2 Use the [TAB] buttons to call up the desired page.

3 Press the [MIXING CONSOLE] button several times until the desired parts are displayed. Pressing the [MIXING CONSOLE] button alternates among the displays as listed below.

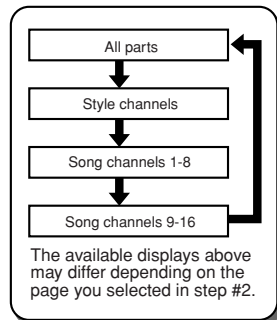
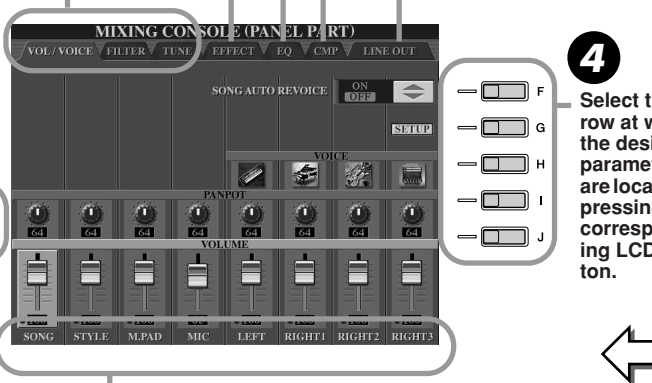
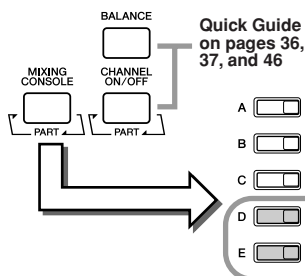

4 Select the row at which the desired parameters are located by pressing the corresponding LCD button.

5 Set each parameter.

6 If necessary, store the settings from the Mixing Console display.

Basic instructions on saving the settings are given below, and brief explanations of the parameters are on the next page. For details on the parameters, refer to the separate Data List booklet.

- The settings of the keyboard parts, Style part, Multi Pad part, and Microphone sound part can be memorized to the Registration Memory (page 52).
- The settings of the Song part can be saved as a song to the User drive or external devices. After setting, call up the CHANNEL display of the Song Creator, press the [EXECUTE] LCD button on this display to reflect the settings to the song data on RAM, then save the song to the User drive or external devices (page 56).

Part Settings

The explanations here apply to step #5 of the Basic Procedure on page 179. The parameters explained below can be set on the display pages called up in step #2 of the Basic Procedure on page 179.

VOL/VOICE page parameters

SONG AUTO REVOICE	See page 181.
VOICE	Calls up the VOICE display, from which you can select the desired voice for each part. When the Style channels are called up in step #3 of the Basic Procedure on page 179, neither Organ Flutes voices nor User voices can be selected. When the Song channels are called up in step #3 of the Basic Procedure on page 179, User voices cannot be selected. Please note that the voice of the Multi Pad cannot be changed via the Mixing Console.
PANPOT	Determines the stereo position of the selected part (channel). A setting of 0 pans the sound hard left, while 64 is at center, and 127 is at hard right.
VOLUME	Determines the level of each part or channel, giving you fine control over the balance of all the parts.

NOTE

- The RHY1 channel in the STYLE PART display can be assigned to any voice except the Organ Flute voice.
- When playing GM song data, channel 10 (in the SONG CH 9–16 page) can only be used for a Drum Kit voice.
- When changing the rhythm/percussion voices (drum kits, etc.) of the style and song from the VOICE parameter, the detailed settings related to the drum voice are reset, and in some cases you may be unable to restore the original sound. In the case of song playback, you can restore the original sound by returning to the beginning of the song and playing back from that point. In the case of style play, you can restore the original sound by selecting the same style again.

FILTER page parameters

HARMONIC CONTENT	Allows you to adjust the resonance effect (page 92) for each part.
BRIGHTNESS	Determines the brightness of the sound for each part by adjusting the cutoff frequency (page 92).

TUNE page parameters

PORTAMENTO TIME	Portamento is a function that creates a smooth transition in pitch from the first note played on the keyboard to the next. The Portamento Time determines the pitch transition time. Higher values result in a longer pitch change time. Setting this to "0" results in no effect. This parameter is available when the selected keyboard part is set to Mono (page 87).
PITCH BEND RANGE	Determines the range of the PITCH BEND wheel for each keyboard part. The range is from "0" to "12" with each step corresponding to one semitone.
OCTAVE	Determines the range of the pitch change in octaves, over two octaves up or down for each keyboard part. The value set here is added to the setting via the [OCTAVE] button.
TUNING	Determines the pitch of each keyboard part.
TRANPOSE	Allows the pitch to be transposed up or down in semitone increments. Setting this to "MASTER" transposes the overall sound of the instrument, while "SONG" transposes song playback, and "KEYBOARD" transposes the keyboard pitch, as well as that of style playback and the Multi Pads (since these are also affected by keyboard play in the left-hand section).

NOTE

- As described at left, in addition to the Master Transpose setting, there are two other transpose controls: Keyboard Transpose and Song Transpose. These can be used to match both the song and your keyboard performance to a certain key. For example, let's say you wish to both play and sing along with a certain recorded song. The song data is in F, but you feel most comfortable singing in D, and you are accustomed to playing the keyboard part in C. To match up the keys, set the Master Transpose to "0," the Keyboard Transpose to "2," and the Song Transpose to "-3." This brings the keyboard part up and the song data down to your comfortable singing key.

EFFECT page parameters

TYPE	Page 183
REVERB	Adjusts the Reverb Send Level (page 182) for each part or channel.
CHORUS	Adjusts the Chorus Send Level (page 182) for each part or channel.
DSP	Adjusts the DSP Effect Dry/Wet Level for each part or channel.

EQ page parameters

TYPE	Page 184
EDIT	Page 184
EQ HIGH	Determines the center frequency of the high EQ band that is attenuated/boosted for each part.
EQ LOW	Determines the center frequency of the low EQ band that is attenuated/boosted for each part.

Song Auto Revoice

This feature lets you use the stunning sound of the Tyros2 to full advantage with XG-compatible song data. When you play back any commercially available XG song data or that created on other instruments, you can use Auto Revoice to automatically assign the specially created voices of the Tyros2 (Live!, Cool!, etc.) instead of the conventional XG voices of the same type. To do this, simply turn on Song Auto Revoice (from the VOL/VOICE display page), and the Tyros2 uses its unique, superior sound set instead of the normal XG counterparts. You can even specify your own favorite voices for this function and make other detailed settings via the [SETUP] LCD button.

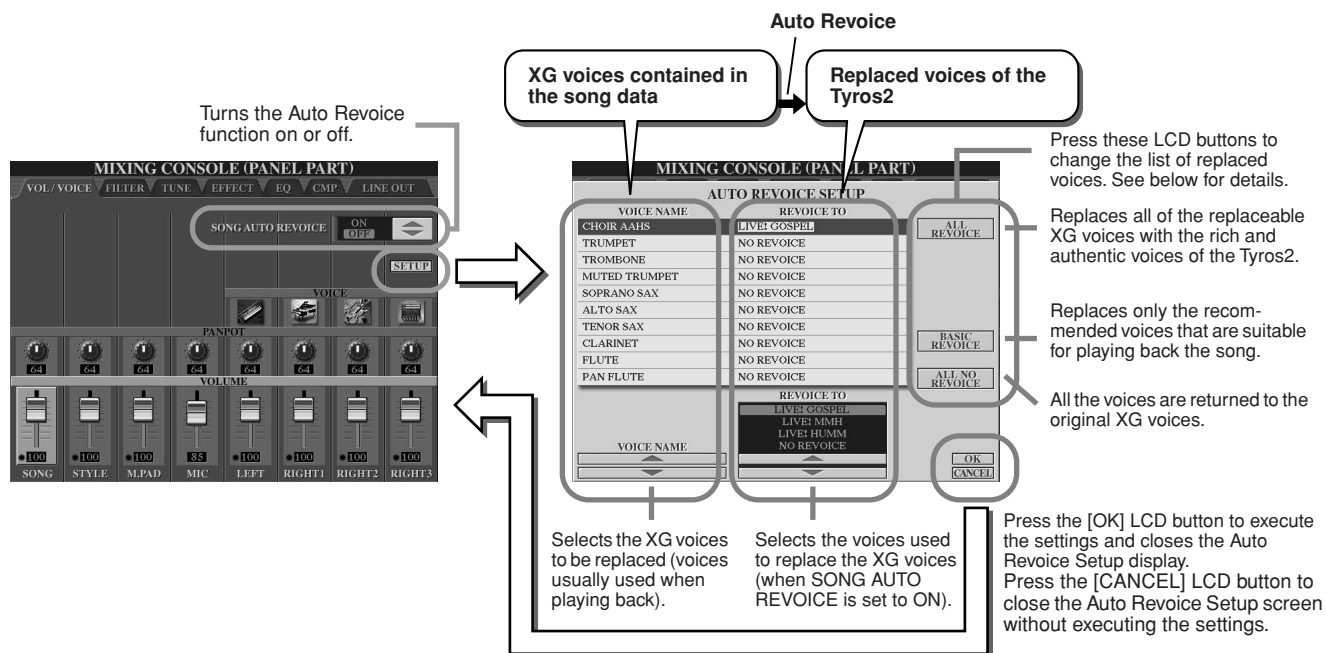

Effects

The Tyros2 has a wide variety of high-quality effects—including Reverb, Chorus, and a diverse selection of DSP (Digital Signal Processor) effects—that can be used to independently enhance or change the sound of the various parts (keyboard, style, song, Multi Pads, and microphone sound).

■ Effect Block

	Parts to which the effects are applied	Characteristics	Effect Connection	Number of User Effect
Reverb	All parts	Reproduces the warm ambience of playing in a concert hall or jazz club.	System	3
Chorus	All parts	Produces a rich “fat” sound as if several parts are being played simultaneously.	System	3
DSP1	Style part (all channels) + Song part (all channels)	In addition to the Reverb and Chorus types, the Tyros2 has special DSP effects, that include additional effects usually used for a specific part, such as distortion and tremolo.	System/ Insertion	3
DSP2 DSP3 DSP4 DSP5	RIGHT 1, RIGHT 2, RIGHT 3, LEFT, Song part (all channels)	Any unused DSP blocks are automatically assigned to the appropriate parts (channels) as needed.	Insertion	10
DSP6	Microphone sound	Dedicated for use only with the microphone sound.	Insertion	10
Vocal Harmony	Microphone sound	Page 175	Insertion	10
Master EQ	All parts	Page 184	System	2
Part EQ	Style part (all channels), Multi Pad part, Song part (all channels), RIGHT 1, RIGHT 2, RIGHT 3, LEFT	Page 180	—	0
Master Compressor	All parts	Page 185	System	5

■ System Effects and Insertion Effects

All the effect blocks are connected or routed in one of two ways: System or Insertion. System applies the selected effect to all parts, while Insertion applies the selected effect to one specific part.

The DSP 1 effect can be configured for either System or Insertion routing via the Effect Parameter settings (page 183).

■ Effect Signal Flow Chart

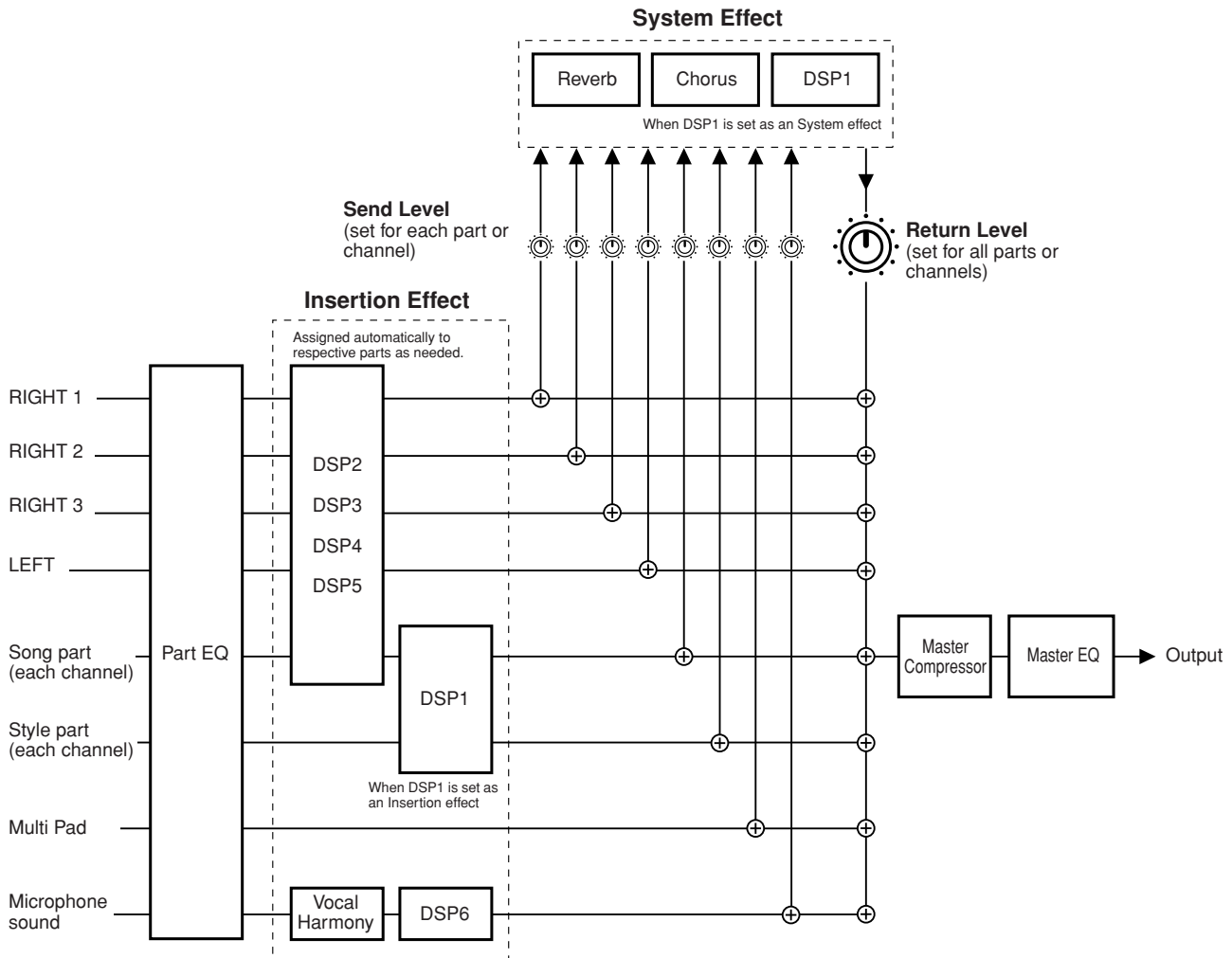

NOTE

• About DSP 1

In most cases, the DSP 1 effect block is available for either the song or style part. For songs and styles, the effect block is applied to only the last selected or played part.

For example, when selecting or starting a song during style playback, the DSP 1 effect applied to the style part is cancelled and is applied instead to the song part. Particularly if the style data originally is processed with a distortion effect of DSP 1, this operation may result in disrupting the overall volume balance among the style parts (channels).

Note that the same problem may occur when starting or selecting a style during song playback.

• About DSP 2–5

The effect blocks DSP 2 through 5 are available independently for the keyboard parts and song parts. Only that part which has been assigned to an effect block can use that effect. For example, if you select or start a song, the DSP effect applied to the keyboard part is cancelled and is applied instead to the song. Pressing the [DSP] button on the panel restores the corresponding effect block to the current keyboard part (from the song).

■ Selecting an Effect type and creating a User Effect

Various types of Effects are provided for each Effect Block listed on page 182. Each Effect type can be edited with the parameters (see the Effect Type Edit display below) and saved as a User Effect Type.

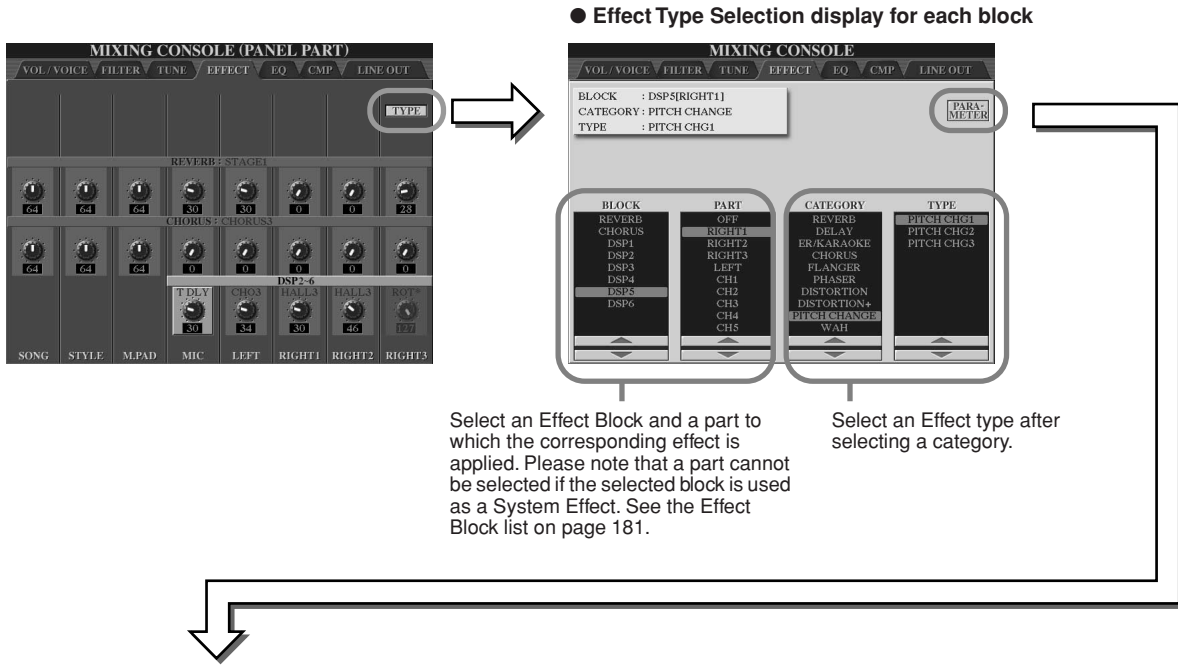

● Effect Type Edit

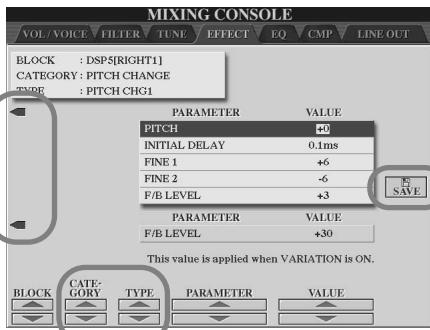

Select a block to which the desired effect type belongs.

When the edited effect block is a System Effect, the Effect Return Level parameter (page 182) can be adjusted here.

Set the value of the parameter selected at left.

Select a parameter to be edited. Parameters displayed differ depending on the selected Effect type. Refer to the separate Data List booklet for details.

Select an Effect category/type to be edited.

The value of the parameters when turning the [VARIATION] on can be set as for the DSP2-5 blocks. Use these LCD buttons to switch between the upper/lower parameters. For the lower parameter, the depth can be changed when the [VARIATION] button is on.

● User Effect Type Save

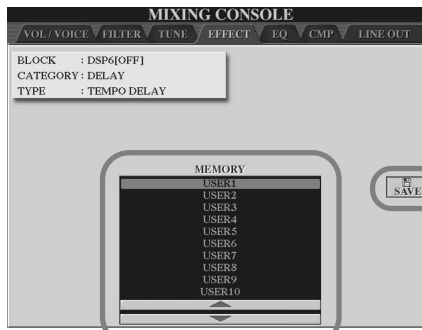

Select the destination to which the effect is to be stored. The number of memory spaces available for the destination differs for each block (page 181).

Pressing the [SAVE] LCD button calls up the pop-up window for entering the name of the edited Effect type. Enter the desired name and press the [OK] LCD button to save the edited effect to the location specified at left.

NOTE

- Keep in mind that in some cases noise may result if you adjust the effect parameters while playing the instrument.

Equalizer (EQ)

Equalizer (also called “EQ”) is a sound processor that divides the frequency spectrum into multiple bands which can be boosted or cut as required to tailor the overall frequency response.

Usually an equalizer is used to correct the sound from speakers to match the special character of the room. The sound is divided into several frequency bands, allowing you to correct the sound by raising or lowering the level for each band. EQ allows you to adjust the tone or timbre of the sound to match the performance space, or to compensate for certain acoustic characteristics in your room. For example, you can cut some of the low range frequencies when playing in large spaces where the sound is too “boomy,” or boost the high frequencies in rooms and close spaces where the sound is relatively “dead” and free of echoes. The Tyros2 possesses a high grade five-band digital EQ. With this function, a final effect—tone control—can be added to the output of your instrument. You can even create your own custom EQ settings by adjusting the frequency bands, and save the settings to one of two User Master EQ types. Along with the five Preset EQ settings, these can be called up as needed from the [MIXING CONSOLE] → EQ display.

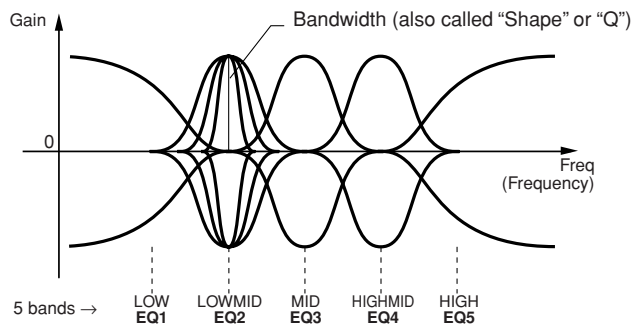

● Master EQ type selection and Part EQ adjusting



Select a Master EQ type.

● Master EQ type editing

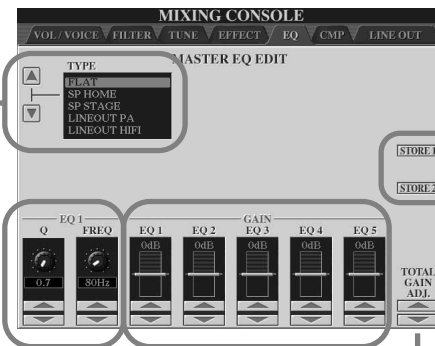

Selecting a Master EQ type automatically set the parameters displayed at the bottom of this display.

The PRESET and USER curves can be edited as required via the corresponding buttons. Each of the five bands can be boosted or cut by up to 12 dB.

Use the [STORE] LCD buttons to call up the pop-up window for entering the name of the edited Master EQ type. Enter the desired name and press [OK] to save. Up to two types of EQ can be created and saved.

Adjusts the overall gain of all EQ bands simultaneously.

Whenever an EQ band is edited, the corresponding EQ value is highlighted and the number of the edited band appears above the Q and FREQ controls. The Q and FREQ controls can then be used to adjust the Q (bandwidth) and the FREQ (center frequency) of the selected band. The higher the Q setting, the narrower the bandwidth. The available FREQ range is different for each band.

Master Compressor

Compressor is an effect commonly used to limit and compress the dynamics (softness/loudness) of an audio signal. For signals that vary widely in dynamics, such as vocals and guitar parts, it “squeezes” the dynamic range, effectively making soft sounds louder and loud sounds softer. When used with gain to boost the overall level, this creates a more powerful, more consistently high-level sound. Compression can be used to increase sustain for electric guitar, smooth out the volume of a vocal, or bring a drum kit or rhythm pattern further up-front in the mix.

The Tyros2 has a sophisticated multi-band compressor that allows you to adjust the compression effect for individual frequency bands—giving you detailed sonic control. You edit and save your own custom Compressor types, or conveniently select from one of the presets by calling up the [MIXING CONSOLE] → CMP display.

● Master Compressor type selection and editing

Selecting a Master Compressor type automatically sets the parameters (at the bottom of the display) to the optimum values for the type.

Turns the Master Compressor effect on or off.

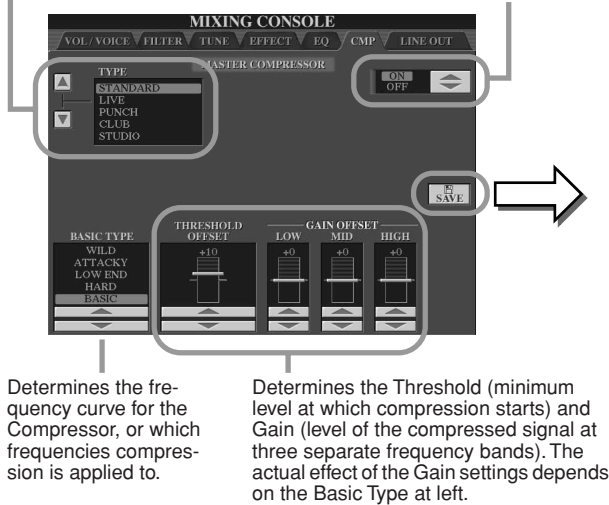

● Master Compressor saving

The following display lets you save the Master Compressor settings from the display shown at left as a User Compressor type.

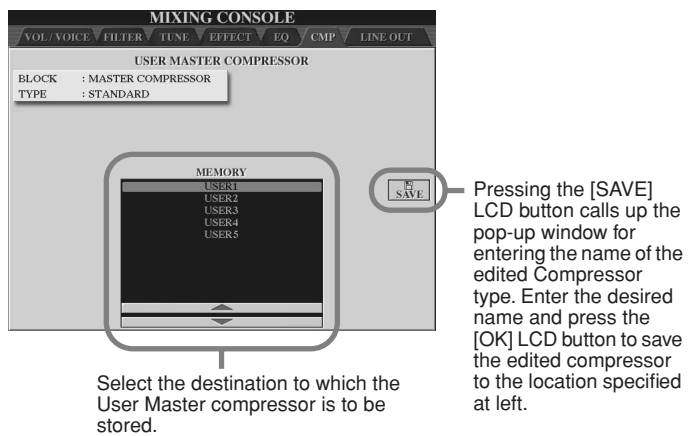

Line Out Settings

The [MIXING CONSOLE] → LINE OUT display allows you to send the output of a selected Part or Parts to the LINE OUT jacks. For Drum Parts, you can even select specific drum sounds to be output through these jacks.

In general, the extensive built-in effects and other Part controls of the Tyros2 provide all you need for processing and mixing complex multi-Part songs. However, there may be times when you want to “sweeten” or process a certain Voice or sound with a favorite outboard effect unit, or record a Part to a separate track of a tape recorder. The Line Out settings are designed just for these kinds of applications.

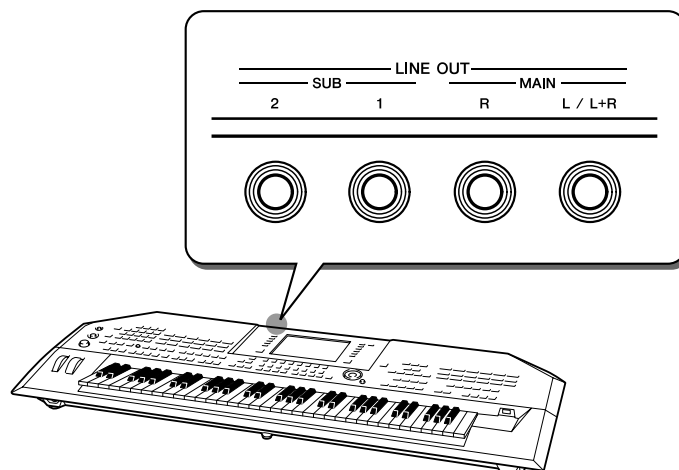

● Line Out settings for each part or channel

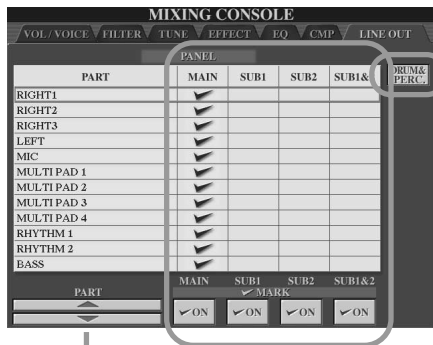

Set the output configuration for the selected part by checkmarking or un-checkmarking the appropriate column (jack).

Select the desired part.

● Line Out settings for each instrument (key)

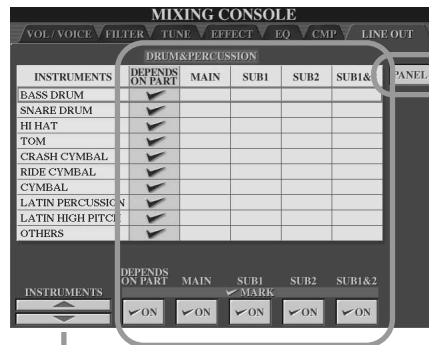

Set the output configuration for the selected drum sound by checkmarking or un-checkmarking the appropriate column (jack).

- **When checkmarking the box of "DEPEND ON PART":**
The selected drum sound will be output via the jacks set from the PANEL page at left.

- **When checkmarking the box of one of a column other than "DEPEND ON PART":**
An individual percussion setting overrides the Part settings made from the PANEL page at left.

Select the desired drum instrument.

■ MAIN jacks

The part, channel or percussion sound of which the MAIN box is checkmarked will be output from the following jacks. This output sound includes the effect settings.

- MAIN jacks on the rear panel
- PHONES jack
- LOOP SEND jack
- Optional Speaker

■ SUB jacks

The part, channel, or percussion sound of which the SUB1, SUB2, or SUB1&2 box is checkmarked will be output from the jacks as described below.

- When any of the SUB1/SUB2/SUB1&2 boxes are checkmarked, the part (channel) or percussion sound will be output via the corresponding jacks. In this case, only Insertion effects can be applied; System effects and other effects will not be applied to the output sound.
- When any of the SUB1/SUB2/SUB1&2 boxes are checkmarked, the part (channel) or percussion sound will not be output through the MAIN/PHONES/LOOP SEND jack or optional connected speakers.
- When the SUB1&2 box is checkmarked, the part (channel) or percussion sound will be output in stereo (1: left, 2: right).
- When the SUB1/SUB2 box is checkmarked, the part (channel) or percussion sound will be output in mono, respectively.

NOTE

- When using one of the SUB Line Out settings, make sure that you've connected cables to the appropriate LINE OUT SUB jacks on the rear panel. If cables are only connected to the MAIN jacks, the sound of the Part will be output through the MAIN jacks, even if one of the SUB1/SUB2/SUB1&2 is checkmarked.

Making Global and Other Important Settings—Function

The Function menu called up by pressing the [FUNCTION] button gives you access to various advanced functions related to the instrument as a whole. These sophisticated functions let you customize the Tyros2 to your own musical needs and preferences.

Basic Procedure (Function)

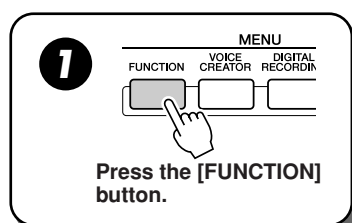

2 Select the desired menu by pressing the corresponding LCD button.

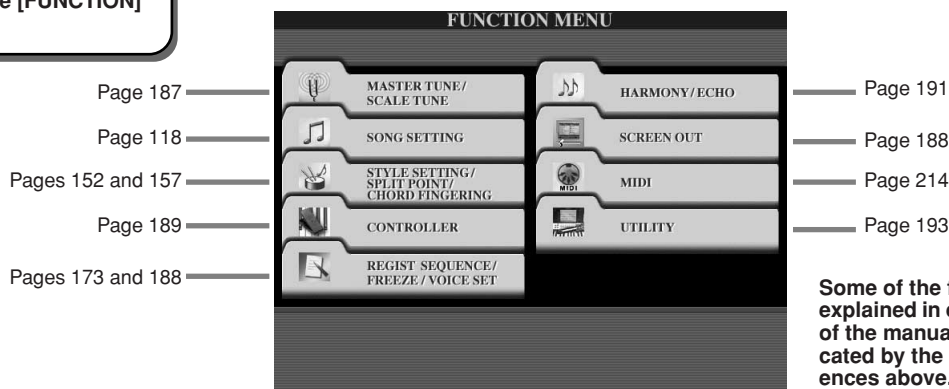

Some of the functions are explained in other sections of the manual, and are indicated by the page references above.

NOTE

- How to save the settings differs depending on the menu. For details, see the page of each menu and refer to the Parameter Chart in the separate Data List booklet.

3 Set the desired parameters on each display.

Tuning

Parameters set on the display called up by selecting “MASTER TUNE/SCALE TUNE” in step #2 of the Basic Procedure above are explained below.

■ MASTER TUNE

The [FUNCTION] → MASTER TUNE/SCALE TUNE → MASTER TUNE display allows you to make fine adjustments to the overall pitch of the instrument, from 414.8–466.8 Hz by using the corresponding the lower and upper LCD buttons—letting you accurately match the tuning with that of other instruments. Press the corresponding lower and upper buttons simultaneously to instantly reset the value to the factory setting of 440.0 Hz.

Please note that the Tune function does not affect the Drum Kit or SFX Kit voices.

■ SCALE TUNE

The [FUNCTION] → MASTER TUNE/SCALE TUNE → SCALE TUNE display determines the particular tuning system (or temperament) for the instrument. This function allows each individual note of the octave to be tuned in cents (1 cent = 1/100th of a semitone) for each part—especially useful for playing period pieces, to match the tuning system used during specific musical eras.

Select a scale type to instantly call up one of the pre-programmed Scale Tune settings.

Determines the base note for each scale. When the base note is changed, the pitch of the keyboard is transposed, yet maintains the original pitch relationship between the notes.

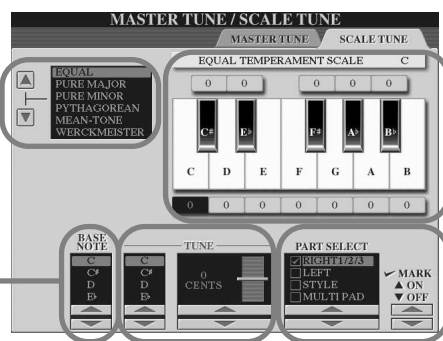

Select the desired note and tune it.

NOTE

- The Scale Tune settings here can be memorized to the Registration Memory.

The current tuning of each note is shown in the corresponding key.

Select the part to which the Scale Tune setting here is applied by checkmarking the box.

Preset Scale type

Scale name	Description
EQUAL	The pitch range of each octave is divided equally into twelve parts, with each half-step evenly spaced in pitch. This is the most commonly used tuning in music today.
PURE MAJOR PURE MINOR	These tunings preserve the pure mathematical intervals of each scale, especially for triad chords (root, third, fifth). You can hear this best in actual vocal harmonies—such as choirs and acapella singing.
PYTHAGOREAN	This scale was devised by the famous Greek philosopher and is created from a series of perfect fifths, which are collapsed into a single octave. The 3rd in this tuning are slightly unstable, but the 4th and 5th are beautiful and suitable for some leads.
MEAN-TONE	This scale was created as an improvement on the Pythagorean scale, by making the major third interval more “in tune.” It was especially popular from the 16th century to the 18th century. Handel, among others, used this scale.
WERCKMEISTER KIRNBERGER	This composite scale combines the Werckmeister and Kirnberger systems, which were themselves improvements on the mean-tone and Pythagorean scales. The main feature of this scale is that each key has its own unique character. The scale was used extensively during the time of Bach and Beethoven, and even now it is often used when performing period music on the harpsichord.
ARABIC1, 2	Use these tunings when playing Arabic music.

Voice Set

Parameters set on the VOICE SET display called up via the [FUNCTION] → REGISTRATION MEMORY/FREEZE/VOICE SET → VOICE SET are explained here.

When changing voices (selecting a voice file), the settings best matching the voice—the same as those set in the Voice Set—are always and automatically called up. From this page, you can set the on/off status for each part. Normally, it is recommended that these are set to “ON.”

Use these to select the desired part.

These determine whether the corresponding voice-related settings are automatically called up or not when you select a voice. These settings can be turned on or off independently for each part.

Screen Out Settings

Parameters set on the display called up by selecting “SCREEN OUT” in step #2 of the Basic Procedure on page 187 are explained below. You can connect the Tyros2 to a computer monitor, television or video monitor to display the lyrics and chords in your song data on a larger screen. For information on the RGB OUT and VIDEO OUT connections, see page 16.

Select the desired output monitor type. (RGB OUT delivers higher resolution than VIDEO OUT.) If you select VIDEO, set this to correspond to the standard (VIDEO (NTSC) or VIDEO (PAL)) used by your video equipment. The default setting is “VIDEO (PAL).” If the standard used by your television or video monitor is not VIDEO (PAL) (for example, VIDEO (NTSC) is generally used in North America), change the setting to “VIDEO (NTSC).”

Determines the contents of the Video Out signal, or which data is sent to the video monitor.

- **LYRICS/TEXT**

Only the lyrics of the song or text are output via RGB OUT or VIDEO OUT, regardless of the display that is called up on the instrument itself. This lets you select other displays and still have the lyrics/text shown on the monitor.

- **LCD**

The currently selected display is output via RGB OUT or VIDEO OUT.

NOTE

- Occasionally some flashing parallel lines may appear in the television or video monitor. This does not necessarily indicate that the monitor is malfunctioning. You may be able to remedy the situation by changing the Character Color or Background Color parameters. For optimum results, also try adjusting the color settings on the monitor itself.
- Avoid looking at the monitor for prolonged periods of time since doing so could damage your eyesight. Take frequent breaks and focus your eyes on distant objects to avoid eyestrain.
- Keep in mind that even after adjusting all settings as recommended here, the monitor you are using may not show the Tyros2's display contents as expected (e.g., the display contents may not fit on the screen, the characters may not be completely clear, or the colors may be incorrect).

Controller

Parameters set on the display called up by selecting “CONTROLLER” in step #2 of the Basic Procedure on page 187 are explained below. This display lets you make settings for controllers with which the Tyros2 is equipped (including the keyboard, modulation wheel, pitch bend wheel) and which are connected to the Tyros2 (including the footswitch and foot controller).

■ FOOT PEDAL

From the [FUNCTION] → CONTROLLER → FOOT PEDAL display, you can assign one of various functions to each foot pedal (footswitch or foot controller) connected to the Tyros2.

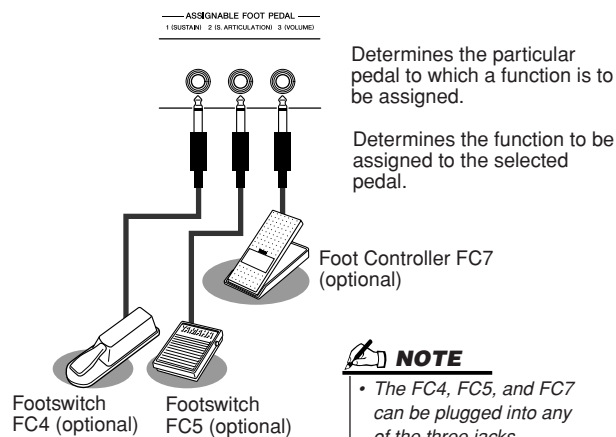

NOTE
• The FC4, FC5, and FC7 can be plugged into any of the three jacks.

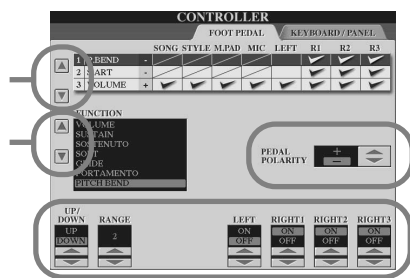

Pedal on/off operation may differ depending on the particular pedal you've connected to the Tyros2. For example, pressing down on one pedal may turn the selected function on, while pressing a different make/brand of pedal may turn the function off. If necessary, use this setting to reverse the operation.

If necessary, set the parameters related to the selected function. Displayed parameters differ depending on the selected function.

Functions that can be assigned to the foot pedal (footswitch, foot controller)

VOLUME*	Allows you to use a foot controller to control the volume. You can turn this pedal function on or off for each part on this display.
SUSTAIN	When the pedal is pressed, notes played have a long sustain. Releasing the pedal immediately stops (damps) any sustained notes. You can turn this pedal function on or off for each keyboard part on this display. If you press and hold the foot switch here, all the notes shown will be sustained.
SOSTENUTO	If you press and hold the pedal here, only the first note will be sustained (the note that you played and held when pressing the pedal). This makes it possible to sustain a chord, for example, while other notes are played staccato. You can turn this pedal function on or off for each keyboard part on this display. If you press and hold the foot switch here, only the first note will be sustained (the note that you played and held when pressing the foot switch).
SOFT	When you press the foot switch, the soft effect is applied to the keyboard notes. You can turn this pedal function on or off for each keyboard part on this display.
GLIDE	When the pedal is pressed, the pitch changes, and then returns to normal pitch when the pedal is released. The following parameters can be set for this function on this display. • UP/DOWN—determines whether the pitch change goes up (is raised) or down (is lowered) • RANGE—determines the range of the pitch change, in semitones • ON SPEED—determines the speed of the pitch change when the pedal is pressed • OFF SPEED—determines the speed of the pitch change when the pedal is released • LEFT, RIGHT 1, 2, 3—turns this pedal function on or off for each keyboard part
PORTAMENTO	The portamento effect (a smooth slide between notes) can be produced while the pedal is pressed. Portamento is produced when notes are played legato style (i.e., a note is played while the preceding note is still held). The portamento time can be set via the Mixing Console display. You can turn this pedal function on or off for each keyboard part on this display.
PITCHBEND*	Bend notes up or down while pedal is pressed. The following parameters can be set for this function on this display. • UP/DOWN—determines whether the pitch change goes up (is raised) or down (is lowered) • RANGE—determines the range of the pitch change, in semitones • LEFT, RIGHT 1, 2, 3—turns this pedal function on or off for each keyboard part

MODULATION*	Applies a vibrato effect to notes played on the keyboard.
S. ARTICULATION	When you use a Super Articulation voice that has an effect assigned to the pedal, you can enable the effect by pressing the footswitch. You can turn this function on or off for each keyboard part on this display.
DSP VARIATION	Same as the [DSP VARIATION] button on the panel. You can turn this pedal function on or off for each keyboard part on this display. This allows you to use the foot pedal to control [DSP VARIATION] for only the current keyboard part, or for multiple keyboard parts simultaneously.
HARMONY/ECHO	Same as the [HARMONY/ECHO] button.
VOCAL HARMONY	Same as the [VOCAL HARMONY] button.
TALK	Same as the [TALK] button.
SCORE PAGE +	While the song is stopped, you can turn to the next score page (one page at a time).
SCORE PAGE -	While the song is stopped, you can turn to the previous score page (one page at a time).
LYRICS PAGE +	While the song is stopped, you can turn to the next lyrics page (one page at a time).
LYRICS PAGE -	While the song is stopped, you can turn to the previous lyrics page (one page at a time).
TEXT PAGE +	You can turn to the next text page (one page at a time)
TEXT PAGE -	You can turn to the previous text page (one page at a time).
HDR PLAY/PAUSE	Same as the HARD DISK RECORDER [PLAY/PAUSE] button.
SONG PLAY/PAUSE	Same as the SONG [PLAY/PAUSE] button.
STYLE START/STOP	Same as the STYLE [START/STOP] button.
TAP TEMPO	Same as the [TAP TEMPO] button.
SYNCHRO START	Same as the [SYNC. START] button.
SYNCHRO STOP	Same as the [SYNC. STOP] button.
INTRO 1	Same as the [INTRO I] button.
INTRO 2	Same as the [INTRO II] button.
INTRO 3	Same as the [INTRO III] button.
MAIN A	Same as the MAIN [A] button.
MAIN B	Same as the MAIN [B] button.
MAIN C	Same as the MAIN [C] button.
MAIN D	Same as the MAIN [D] button.
FILL DOWN	A fill-in plays, automatically followed by the Main section of the button on the immediate left.
FILL SELF	A fill-in plays, automatically followed by the previously played Main section.
FILL BREAK	A break plays, automatically followed by the previously played Main section.
FILL UP	A fill-in plays, automatically followed by the Main section of the button on the immediate right.
ENDING1	Same as the [ENDING/rit. I] button.
ENDING2	Same as the [ENDING/rit. II] button.
ENDING3	Same as the [ENDING/rit. III] button.
FADE IN/OUT	Same as the [FADE IN/OUT] button.
FINGERD/FING ON BASS	The pedal alternately switches between two Chord Fingering types: Fingered and On Bass (page 153).
BASS HOLD	While the pedal is pressed, the Style bass note will be held even if the chord is changed. If the fingering is set to "FULL KEYBOARD," the function does not work.
PERCUSSION	Footswitch plays a percussion instrument selected by the [ASSIGN] LCD buttons.
RIGHT 1 ON/OFF	Same as the PART ON/OFF [RIGHT 1] button.
RIGHT 2 ON/OFF	Same as the PART ON/OFF [RIGHT 2] button.
RIGHT 3 ON/OFF	Same as the PART ON/OFF [RIGHT 3] button.
LEFT ON/OFF	Same as the PART ON/OFF [LEFT] button.
OTS +	Recalls next higher One Touch Setting.
OTS -	Recalls next lower One Touch Setting.

* For best results, use an optional Yamaha FC7 Foot Controller.

 **NOTE**

- The Sostenuto and Portamento functions will not affect the Organ Flutes and Super Articulation Voices, even they have been assigned to the Foot Pedals.

■ **KEYBOARD/PANEL**.....

The [FUNCTION] → CONTROLLER → KEYBOARD/PANEL display lets you set the parameters related to the keyboard and modulation wheel.

● **INITIAL TOUCH** page 87

You can turn Initial Touch on or off for each keyboard part and set the following parameters.

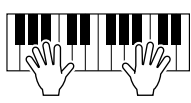
	TOUCH	Determines the Touch sensitivity setting.
	HARD 2	Requires strong playing to produce high volume. Best for players with a heavy touch.
	HARD 1	Requires moderately strong playing for higher volume.
	NORMAL	Standard touch response.
	SOFT 1	Produces high volume with moderate playing strength.
	SOFT 2	Produces relatively high volume even with light playing strength. Best for players with a light touch.
	TOUCH OFF LEVEL	Determines the fixed volume level when Touch is set to "OFF."

 **NOTE**

• Some voices are purposely designed without touch sensitivity, in order to emulate the true characteristics of the actual instrument (for example, conventional organs, which have no touch response).

● **AFTER TOUCH** page 87

You can turn Aftertouch on or off for each keyboard part and set the following parameters.

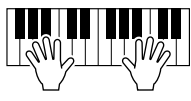
	TOUCH	Determines the Touch sensitivity setting.
	HARD	Relatively strong aftertouch pressure is needed to produce changes.
	NORMAL	Produces a fairly standard aftertouch response.
	SOFT	Allows you to produce relatively large changes with very light aftertouch pressure.

● **MODULATION WHEEL** page 88

You can determine whether the modulation wheel operation is applied or not to the notes for each part.

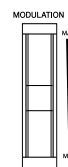

● **TRANPOSE ASSIGN** page 88

You can determine to which parts the [TRANPOSE] button is applied.

KEYBOARD	When this is selected, the [TRANPOSE] button affects the pitch of the keyboard-played voices, style playback (controlled by the performance in the chord section of the keyboard), and Multi Pad playback (when Chord Match is on, and left-hand chords are indicated).
SONG	When this is selected, the [TRANPOSE] button affects only the pitch of the songs.
MASTER	When this is selected, the [TRANPOSE] button affects the pitch of the entire instrument (keyboard voices, styles, and songs).

You can confirm the setting here by viewing the pop-up window called up via the [TRANPOSE] button.

Please note that the transpose function does not affect the Drum Kit or SFX Kit voices.

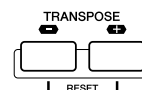

Harmony/Echo

Quick Guide on page 39 ➔

Parameters set on the display called up by selecting "HARMONY/ECHO" in step #2 of the Basic Procedure on page 187 are explained below. This display lets you set the parameters related to the Harmony/Echo effect applied to the keyboard performance when the [HARMONY/ECHO] button is turned on.

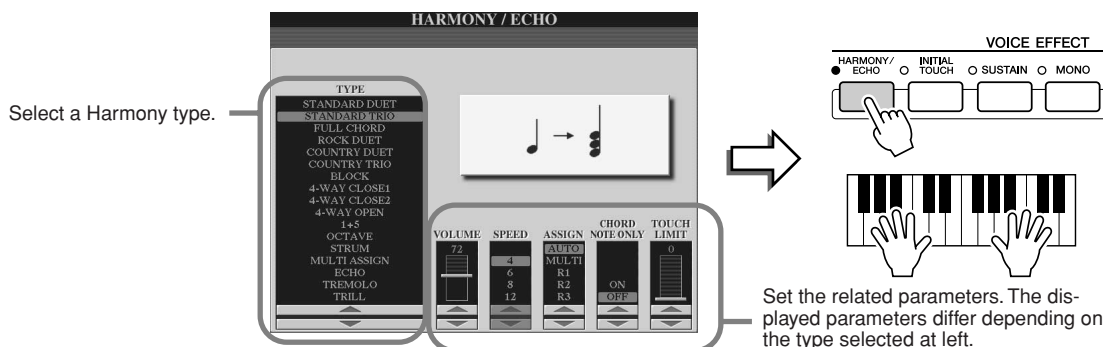

Select a Harmony type.

Set the related parameters. The displayed parameters differ depending on the type selected at left.

TYPE

The Harmony/Echo types are divided into the following groups, depending on the particular effect applied.

Harmony Types

These types apply the harmony effect to the note in the right-hand section of the keyboard according to the chord specified in the left-hand section of the keyboard. (Please note that “1+5” and “Octave” settings are not affected by the chord.)

Multi Assign

This type apply the special effect to the chord played in the right-hand section of the keyboard.



Echo Types

These types apply the echo effect to the note in the right-hand section of the keyboard in time with the currently set tempo.

● Harmony Types

When any of the Harmony Types is selected, the Harmony effect is applied to the note played in the right-hand section of the keyboard according to the type selected above and the chord specified in the chord section of the keyboard shown below.

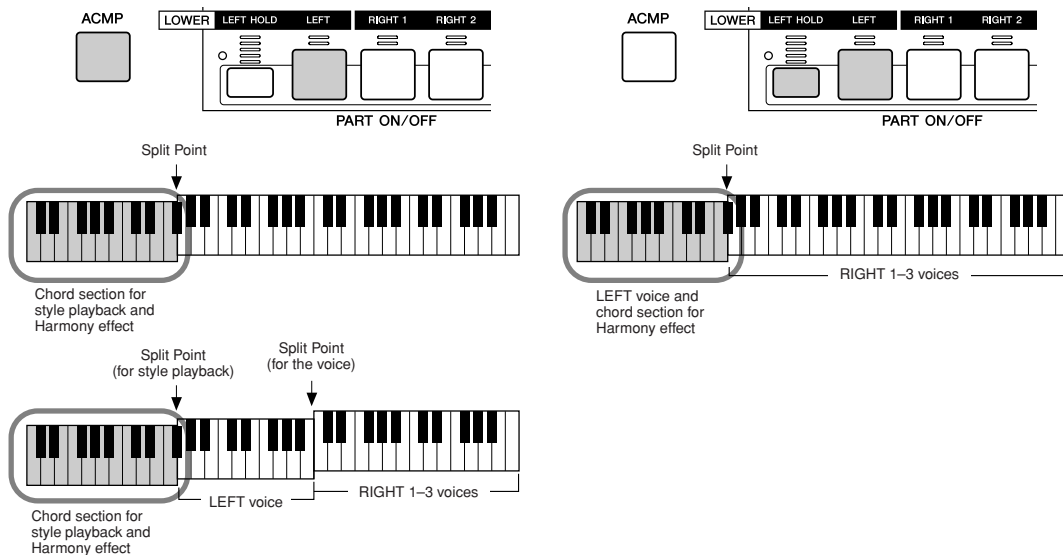

● Echo Types

When any of the Echo Types is selected, the corresponding effect (echo, tremolo, trill) is applied to the note played in the right-hand section of the keyboard in time with the currently set tempo, regardless of the [ACMP] and the LEFT part on/off status. Please note that two notes held on the keyboard are played alternately when Trill is selected.

● Multi Assign Type

Multi Assign automatically assigns notes played simultaneously on the right-hand section of the keyboard to separate parts (voices). For example, if you play three consecutive notes, the first is played by the RIGHT 1 voice, the second by the RIGHT 2 voice, and the third by the RIGHT 3 voice. The Multi Assign effect is not affected by the [ACMP] and LEFT part on/off status.

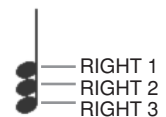

■ Related parameters

- **VOLUME** Determines the level of the harmony/echo notes generated by the Harmony/Echo effect. This parameter is available for all types with the exception of “Multi Assign.”
- **SPEED** Determines the speed of the Echo, Tremolo, and Trill effects. This parameter is only available when Echo, Tremolo, or Trill is selected in Type above.
- **ASSIGN** This lets you determine the keyboard part via which the harmony/echo notes will be sounded. This parameter is available for all types with the exception of “Multi Assign.”
- **CHORD NOTE ONLY** When this is set to “ON,” the Harmony effect is applied only to the note that belongs to a chord played in the chord section of the keyboard. This parameter is not available only for the Harmony type above.
- **TOUCH LIMIT** Determines the lowest velocity value at which the harmony note will sound. This allows you to selectively apply the harmony by your playing strength, letting you create harmony accents in the melody. The harmony effect is applied when you play the key strongly (above the set value). This parameter is available for all types with the exception of “Multi Assign.”

Other Settings (Utility)

Parameters set on the display called up by selecting “UTILITY” in step #2 of the Basic Procedure on page 187 are explained below.

■ CONFIG1.....

The following parameters can be set from the [FUNCTION] → UTILITY → CONFIG1 display.

● Parameters related to the Fade In/Out (page 154)

FADE IN TIME	Determines the time it takes for the volume to fade in, or go from minimum to maximum (range of 0–20.0 seconds).
FADE OUT TIME	Determines the time it takes for the volume to fade out, or go from maximum to minimum (range of 0–20.0 seconds).
FADE OUT HOLD TIME	Determines the time the volume is held at 0 following the fade out (range of 0–5.0 seconds).

● Parameters related to the Metronome

The metronome provides a click sound, giving you an accurate tempo guide when you practice, or letting you hear and check how a specific tempo sounds. The metronome starts by pressing the METRONOME [ON/OFF] button. Adjust the tempo by using the [TEMPO] buttons (page 154). To stop the metronome, press the [ON/OFF] button again.



VOLUME	Determines the level of the metronome sound.
SOUND	Determines whether a bell accent will be sounded or not at the first beat of each measure.
TIME SIGNATURE	Determines the time signature of the metronome sound. Normally, the value matching to the selected style or song is set.

● Parameter Lock

This function is used to “lock” the specified parameters so that they can only be changed directly via the panel controls—in other words, instead of being changed via Registration Memory, One Touch Setting, Music Finder, or song and sequence data.

When the Split Point parameter is locked, for example, the Split Point settings will not be changed via the Registration Memory, One Touch Setting, Music Finder. However, you can change the Split Point settings directly from the [FUNCTION] → SPLIT POINT display.

● Parameters related to the Tap (page 154)

This allows you to set the drum voice and the velocity which will sound when the Tap function is used.

■ CONFIG2.....

The following parameters can be set from the [FUNCTION]→UTILITY→CONFIG2 display.

● Speaker

Determines whether or not the optionally installed speaker will sound.

HEADPHONE SW	Speaker sounds normally, but is cut off when headphones are inserted to the PHONES jack.
ON	Speaker sound is always on.
OFF	Speaker sound is off.

● AUX OUT/LOOP SEND

Select the desired output type corresponding to the AUX OUT/LOOP SEND jack.

● Voice Category Button Options

Determines how the voice Open/Save display is opened when one of the voice buttons is pressed.

OPEN & SELECT	Opens the voice Open/Save display with the top (first) voice of the voice category automatically selected (when one of the voice buttons is pressed).
OPEN ONLY	Opens the voice Open/Save display with the currently selected voice (when one of the voice buttons is pressed).

● Display Voice Number

Determines whether or not the voice bank and number are shown in the Voice selection display (Open/Save display). This is useful when you want to check the proper bank select MSB/LSB values and program number to specify when selecting the voice from an external MIDI device.



NOTE

- For the GS voices, the Display Voice Number is not available (the program change numbers are not shown).

● Display Style Tempo

Selects the default tempo of each style in the style Open/Save display.

● Popup Display Time

Determines the time in which the pop-up windows close. (Pop-up windows are displayed when you press buttons such as TEMPO, TRANSPOSE or UPPER OCTAVE, etc.)

■ MEDIA

From the [FUNCTION] → UTILITY → MEDIA display, you can set or execute important media-related operations (below) for the Tyros2. The word “media” includes the optional USB storage device and optionally installed hard disk drive.

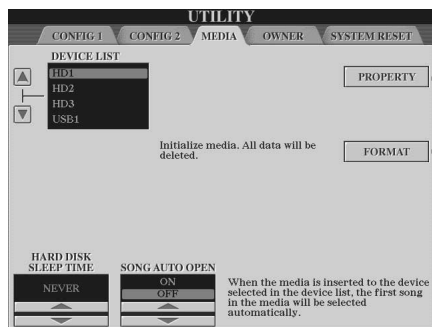

Checking remaining memory on the media (see below).

Formatting a media (see below)

Turns the Song Auto Open function on or off. When this is set to “ON,” the Tyros2 automatically calls up the first song in the media that is inserted to the drive.

The optionally installed hard disk unit will go into a “sleep” mode after a specified time of inactivity, both to maximize the lifetime of the hard disk and to minimize unnecessary mechanical noise. This parameter determines the sleep time.

NOTE

- When you select a song on a CD-ROM drive to be auto-opened, the song may not be called up automatically if the CD-ROM drive takes a lot of time to be recognized.

NOTE

- When using the Hard Disk Recorder function, always set this to “NEVER.” If you set this to something other than “NEVER,” the Hard Disk Recorder may not operate correctly.

IMPORTANT

- If you use the floppy disk, make sure to read the section “Handling the floppy disk drive (FDD) and floppy disks” on page 231.

NOTE

- Commercially available music data is subject to protection by copyright laws. Copying commercially available data is strictly prohibited, except for your own personal use. Some music software is purposely copy-protected and cannot be copied.

● Checking remaining memory on the media (PROPERTY)

You can check the amount of remaining memory on the media.

- ▶ **1** Use the [A]/[B] button to select the desired media.
- ▶ **2** Press the [PROPERTY] LCD button ([F] button) to check the memory size.

● Formatting a media (FORMAT)

Setting up media for use with the Tyros2 is referred to as “formatting.” This function is also useful for quickly deleting unnecessary files from an already formatted media. Be careful when using this operation, since it automatically deletes all data on the media.

- ▶ **1** Use the [A]/[B] button to select the desired media.
- ▶ **2** Press the [FORMAT] LCD button ([H] button) to format the media.

CAUTION

- **Formatting a media completely erases all data on the media. Make sure that the media you’re formatting does not contain important data!**

NOTE

- The Tyros2 is capable of formatting an installed hard disk having a cluster size of less than 32 Kbyte, creating a single partition only; multiple partitions cannot be created. However, if the installed hard disk has been pre-formatted into several partitions on another instrument such as the PSR-9000 or 9000Pro, the Tyros2 can access up to four partitions of the hard disk.

■ Other customizing features—OWNER display

From the [FUNCTION] → UTILITY → OWNER display, you can make other custom settings for the instrument—such as registering your name and importing favorite background pictures.

● LANGUAGE

Determines the language used for the display messages. Once you change this setting, all messages will be shown in the selected language.

● OWNER NAME

Press the [OWNER NAME] LCD button to enter an Owner name. For instructions on naming, see page 76. This name is automatically shown when you turn the power on.

After entering the name, press the [EXIT] button to exit from the UTILITY display, turn the power off, and then on again. You can see the entered name at the bottom of the opening display.



Displaying the version number

To check the version number of this instrument, press and hold the [OWNER NAME] LCD button ([I] button).

● MAIN PICTURE

This function lets you select your favorite picture to be used as background for the Main display. Press the [MAIN PICTURE] LCD button on the [FUNCTION] → UTILITY → OWNER display to call up the Open/Save displays for main pictures. You can select a picture from among various pictures provided on the Preset drive. After selecting, press the [EXIT] button to return to the Main display. The newly selected picture is shown as the background of the Main display.

Using your own pictures

Even though a variety of pictures are available on the preset drive, you can load your own favorite picture data to the Tyros2 for use as background. Keep in mind the following points and limitations when using your own picture data.

- Only bitmap files (.BMP) can be used for the background of the MAIN display.
- Make sure to use images no larger than 640 x 480 pixels. Smaller images are automatically copied and tiled in the display.
- If you select a picture file on the external devices, the background may take some time to appear. If you want to reduce this time, save the background from the device to the USER drive of the Open/Save display for pictures.
- If you select a picture file on the external devices, the selected background will not be displayed when the power is turned on again unless the same device containing the data has been connected.

NOTE

- The explanation about picture compatibility at left applies also to the background of the Song Lyric display.

NOTE

- When the main picture loaded from an external device is not displayed, copy the picture from the device to the USER drive in the instrument and set it as the main background picture. Sometimes the Main display is loaded prior to loading of the picture from an external device.

Data Backup

The backup function provides a convenient backup if the internal memory is damaged. Contents of the backup include the settings of the instrument and the data contained in the USER drive, and can be saved to a USB storage device as one file (Tyros2.bup).

To back up the data, connect the optional USB storage device to the instrument and press the [BACKUP] LCD button ([D] button) in the OWNER display above. To load the backup file to the instrument (restore), connect the device that contains the backup data to the instrument and press the [RESTORE] LCD button ([E] button) in the OWNER display.

CAUTION

- If protected songs are in the USER drive, move them before restoring. Otherwise, the protected songs will be cleared when the backup data is restored.

NOTE

- The Backup/Restore operation takes a few minutes to complete.
- Protected data cannot be backed up. This data remains in the USER drive after the attempted backup operation.
- You cannot restore a backup file that was created on an instrument other than the Tyros2.

System Reset

The explanations here apply to the [FUNCTION] → UTILITY → SYSTEM RESET display.

The screenshot shows the 'UTILITY' menu with 'SYSTEM RESET' selected. The screen displays a list of parameters to be reset: LANGUAGE, OWNER NAME, MAIN PICTURE, LYRICS/TEXT BACKGROUND, SCREEN OUT, and INTERNET SETTING & BOOKMARK. A 'FACTORY RESET EXECUTE' button is visible. A 'CAUTION!' warning states: 'All User files and folders are lost when "FILES&FOLDERS" is selected and Factory Reset is executed.' To the right, a 'SYSTEM SETUP FILES' menu is shown with options: SYSTEM SETUP FILES, MIDI SETUP FILES, USER EFFECT FILES, and MUSIC FINDER FILES.

Factory Reset (factory programmed settings)

2 Press this to execute the Factory Reset operation for all items checked below.

1 Checkmark the box of the item to be reset to the factory programmed settings.

Custom Reset (your own custom settings)

These four settings allow you to program your own reset settings for each of the indicated categories. Press the appropriate LCD button to call up the Open/Save display for the corresponding category and select a file.

Factory Reset—Restoring the factory programmed settings

This function lets you restore the status of the Tyros2 to the original factory settings. You can set whether or not each of the following six items is to be restored to its original factory settings before executing the operation.

SYSTEM SETUP	Restores the System Setup parameters to the original factory settings. You can also restore only the System Setup settings by simultaneously holding down the highest key on the keyboard (C7) and turning on the power. Refer to the separate Data List booklet for details about which parameters belong to the System Setup.
MIDI SETUP	Restores the MIDI settings including the MIDI templates on the User drive to the original factory status.
USER EFFECT	Restores the User Effect settings including the user effect types, user master EQ types, user compressor types, and user vocal harmony types created via the Mixing Console display to the original factory settings.
MUSIC FINDER	Restores the Music Finder data (all records) to the original factory settings (page 172).
FILES & FOLDERS	Deletes all files and folders stored in the User drive.
REGIST	Temporarily deletes the current Registration Memory settings of the selected Bank. The same can be done also by turning the [POWER] switch ON while holding the B6 key (right-most B key on the keyboard).
CUSTOM VOICE	Deletes all Custom Voices (page 85) on the Preset drive.

Custom Reset—Recalling your own custom settings

The four categories of settings below allow you to call up your own custom reset settings from files saved to the User of Disk drive.

SYSTEM SETUP FILES	Parameters set on the various displays such as the [FUNCTION] → UTILITY and microphone setting display are handled as a single System Setup file. Refer to the separate Data List booklet for details about which parameters belong to the System Setup.
MIDI SETUP FILES	The MIDI settings including the MIDI templates on the User drive are handled as a single file.
USER EFFECT FILES	The User Effect settings including the user effect types, user master EQ types, user compressor types, and user vocal harmony types created via the Mixing Console displays are managed as a single file.
MUSIC FINDER FILES	All the preset and created records of the Music Finder are handled as a single file (page 172).

Connecting the Tyros2 Directly to the Internet

You can purchase and download Song data and other types of data from the special Tyros2 website by directly connecting the Tyros2 to the Internet. This section contains terms related to computers and online communications. If there are some terms you are unfamiliar with, refer to the Internet Glossary (page 209).

NOTE

- The special Tyros2 website can be opened when directly connecting the Tyros2 to the Internet.

Connecting the Instrument to the Internet

You can connect the instrument to a full-time online connection (ADSL, optical fiber, cable Internet, etc.) via a router or a modem equipped with a router. For specific instructions on connecting (as well as information on compatible LAN adapters, routers, etc.), refer to the Yamaha Tyros2 website:

<http://music.yamaha.com/tyros2>

Use a computer to connect to the Internet and get online before connecting the instrument, since no modem or router settings can be made from the instrument itself.

To use the Internet connection, you will first need to subscribe to an Internet service or provider.

Connection example 1: Connecting by cable (using a modem without router)

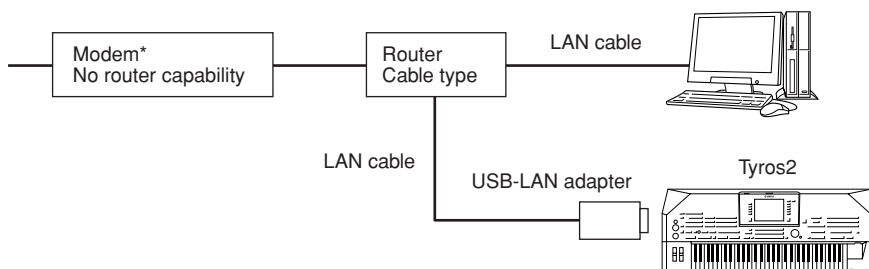

* Here, "modem" refers to an ADSL modem, optical network unit (ONU) or cable modem.

Connection example 2: Connecting by cable (using a modem with router)

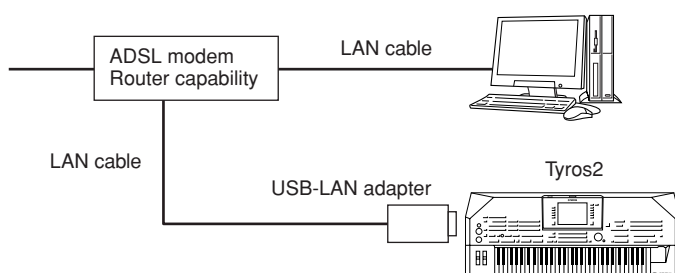

NOTE

- Some types of modems require an optional hub network for simultaneously connecting to several devices (such as computer, musical instrument, etc.).

Connection example 3: Wireless connection

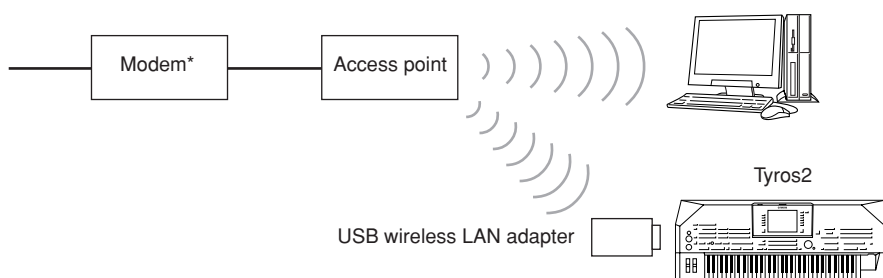

* Here, "modem" refers to an ADSL modem, optical network unit (ONU) or cable modem.

Accessing the Special Tyros2 Website

From the special Tyros2 website, you can audition and purchase Song data, among other things. To access the site, press the [INTERNET] LCD button ([D] button) in the Main display, while the instrument is connected to the Internet.



NOTE

- **Returning to the Main display**
You can conveniently return to the Main display from any other display by simply pressing the [DIRECT ACCESS] button, then the [EXIT] button.
- **Entering characters**
For instructions on entering characters in the website, see page 199.

To close the website display and return to the operation display of the instrument, press the [EXIT] button.

Operations in the Special Tyros2 Website

■ Scrolling the Display

When the size of the web page is too large to be shown at one time in the browser display of the instrument, a scroll bar appears at the right side of the display. Use the [DATA ENTRY] dial to scroll through the display and view those parts of the page that are not shown.

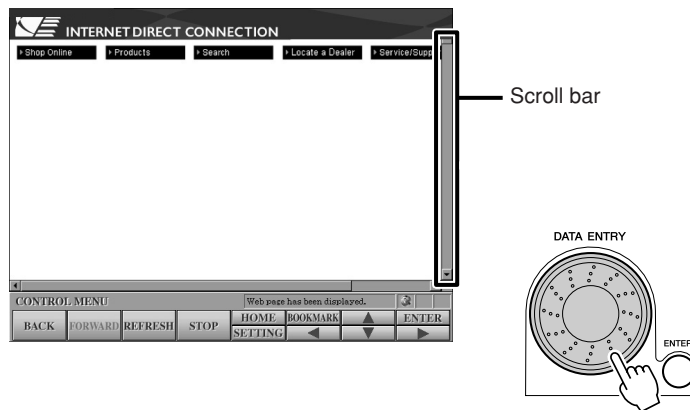

■ Following Links.....

When there is a link in the page, it is shown as a button or in colored text, etc. To select the link, press the [◀]/[▲]/[▼]/[▶] LCD buttons. Press the [ENTER] LCD button (upper [8] button) to actually call up the link destination.

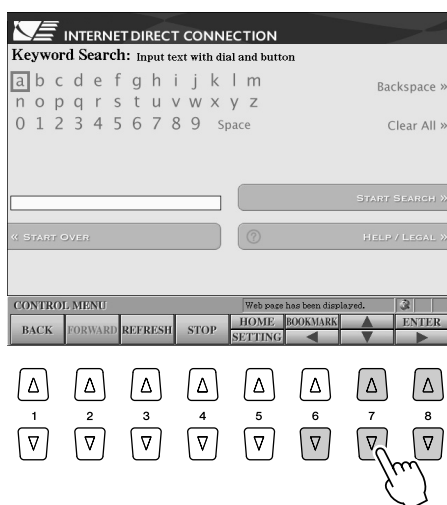

You can also select and call up links by using the [DATA ENTRY] dial and pressing the [ENTER] LCD button (upper [8] button).

When the links are aligned on the right/left side of the display, use the [A]–[J] buttons.

■ Entering Characters.....

This section explains how to enter characters within the website, for inputting a password or searching for data, etc.

- ▶ **1** With the cursor at a field for character entry (such as a password box, or other field; see “Following Links” above), press the [ENTER] LCD button (upper [8] button) to call up the character input display.

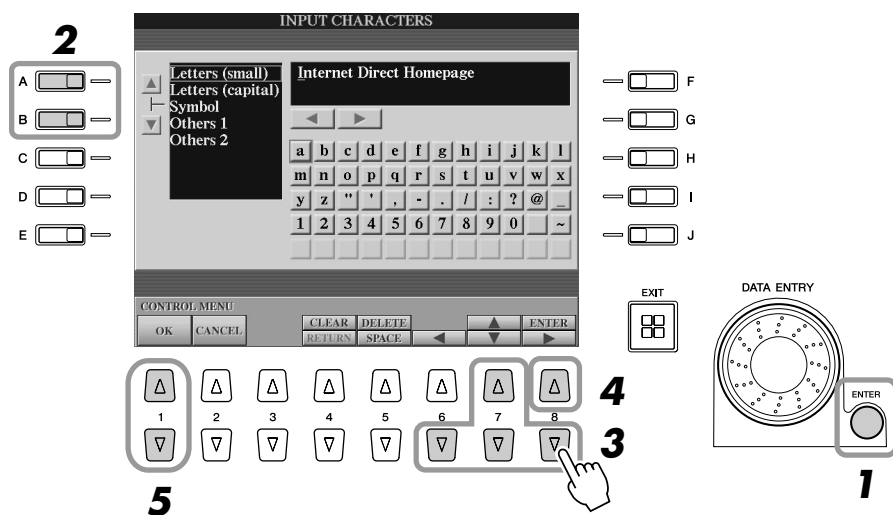

- ▶ **2** Select the desired character type by pressing the [A]/[B] buttons.
- ▶ **3** Use the [◀]/[▲]/[▼]/[▶] LCD buttons to move the red highlight to the desired character.
You can also use the [DATA ENTRY] dial to move the red highlight to the desired position.

► **4 Press the [ENTER] LCD button (upper [8] button) to enter the characters.**

You can also press the panel [ENTER] button to enter the characters.

Deleting Characters

- To delete the previous character, press the [DELETE] LCD button (upper [5] button).
- To delete a specific character:

1 Move the cursor to the character you wish to delete.

1-1 Use the [◀]/[▲]/[▼]/[▶] LCD buttons to move the cursor to “◀▶” below the character box.

1-2 Press the [ENTER] LCD button (upper [8] button) to move the cursor.

2 Press the [DELETE] LCD button (upper [5] button) to delete the character.

- To delete all characters at once, press the [CLEAR] LCD button (upper [4] button) .

Inserting a Character

1 Move the cursor to the desired position.

Use the same operation as in step 1 of “Deleting Characters” above.

2 Use the [◀]/[▲]/[▼]/[▶] LCD buttons to move the red highlight to the desired character.

3 Press the [ENTER] LCD button (upper [8] button) to enter the character.

Entering a Space

1 Move the cursor to the desired position.

Use the same operation as in step 1 of “Deleting Characters” above.

2 Press the [SPACE] LCD button (lower [5] button) to enter a space.

Entering a Line Break (Return)

- When selecting a text box that allows for several lines, press the [RETURN] LCD button (lower [4] button) to enter a line break.

► **5 Press the [OK] LCD button ([1] button) to actually enter the characters.**

To cancel the operation, press the [CANCEL] LCD button ([2] button).

■ **Return to the Previous Web Page**

To return to a previously selected web page, press the [BACK] LCD button ([1] button). To return to the page selected before pressing the [BACK] LCD button ([1] button), press the [FORWARD] LCD button ([2] button).

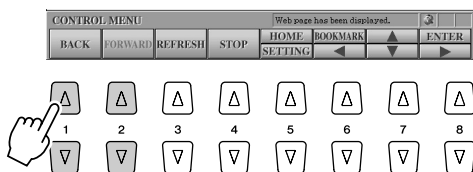

■ Refreshing a Web Page/Canceling Loading of a Web Page

To refresh a web page (to make sure you have the latest version of the page, or to try reloading), press the [REFRESH] LCD button ([3] button).

To cancel loading of a page (if the page is taking too long to open), press the [STOP] LCD button ([4] button).

● Monitoring the Internet Connection Status

The three icons at the bottom right of the Internet display indicate the current Internet connection status.

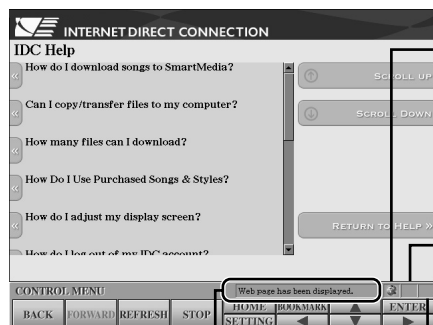

Message area

Online/Offline indicator

Two icons are shown in this area when the instrument is online (connected to the Internet) or offline (disconnected).

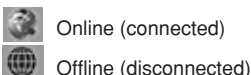

Online (connected)

Offline (disconnected)

SSL indicator

This is shown when the opened website uses SSL, and it indicates that data is encrypted before transmission.

Reception strength indicator (when using wireless LAN connection)

Four icons are shown in this area depending on the wireless reception strength.

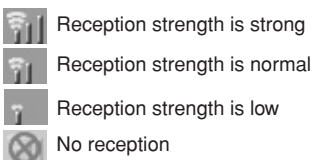

Reception strength is strong

Reception strength is normal

Reception strength is low

No reception

NOTE

- **SSL:**
SSL (Secure Sockets Layer) is an industry-standard method for protecting web communications by using data encryption and other tools.

Purchasing and Downloading Data

You can purchase and download Song data (for playback on this instrument) and other types of data from the special Tyros2 website. For details on purchasing and downloading data, refer to the instructions on the site itself. When several devices are connected to the instrument, the device for saving data is automatically selected in the following order: USB storage device > internal hard disk > USER drive.

■ Operation after purchase and download

When downloading is completed, a message appears asking you whether or not to open the Open/Save display. Select “YES” to call up the Open/Save display, from which you can select the downloaded data. To return to the Internet display, select “NO.” When the Open/Save display is open, press the [UP] LCD button (upper [8] button) to call up the next highest level folder.

The downloaded data is saved in the “MyDownloads” folder in the drive. To close the folder and call up the next highest level folder, press the [UP] LCD button (upper [8] button) in the Open/Save display.

NOTE

- When downloading data to the USB storage device, only use devices whose compatibility has been confirmed by Yamaha as listed on the following web page:
<http://music.yamaha.com/tyros2>

CAUTION

- The purchased data will be lost if you turn the power to the instrument off during download.

Saving Bookmarks of Your Favorite Pages

You can “bookmark” the page you’re viewing, and set up a custom link so the page can be instantly called up in the future.

- ▶ **1** With the desired page currently selected, press the [BOOKMARK] LCD button (upper [6] button). The Bookmark display appears, showing a list of the currently saved bookmarks.
The title of the currently selected web page is shown below the list.
- ▶ **2** Call up the display for registering bookmarks by pressing the [ADD] LCD button ([3] button).

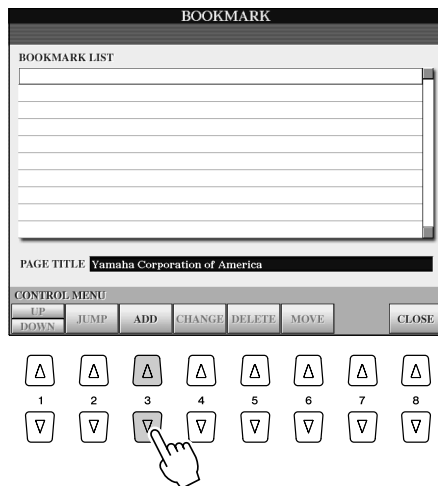

- ▶ **3** Select the position of the new bookmark by pressing the [UP/DOWN] LCD button ([1] button).

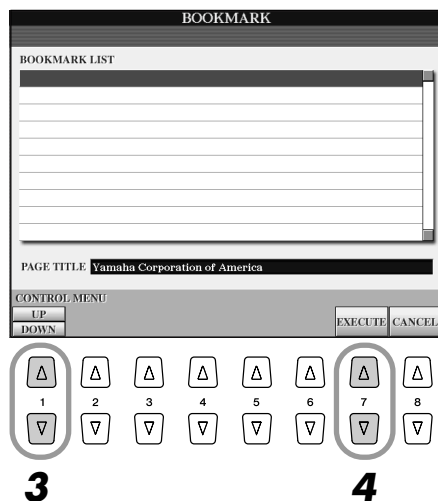

- ▶ **4** To save the bookmark, press the [EXECUTE] LCD button ([7] button), or press the [CANCEL] LCD button ([8] button).
- ▶ **5** To return to the browser, press the [CLOSE] LCD button ([8] button).

■ Opening a Bookmarked Page

- ▶ **1** Press the [BOOKMARK] LCD button (upper [6] button) to call up the Bookmark display.
- ▶ **2** Press the [UP/DOWN] LCD button ([1] button) to select the desired bookmark.

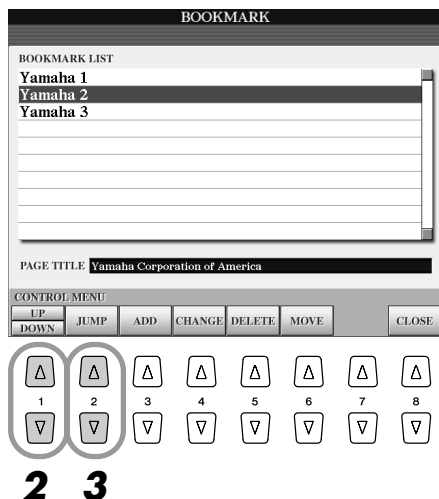

- ▶ **3** Press the [JUMP] LCD button ([2] button) to open the page of the selected bookmark.

■ Editing Bookmarks

From the Bookmark display, you can change the names and rearrange the order of your bookmarks, as well as delete unnecessary bookmarks from the list.

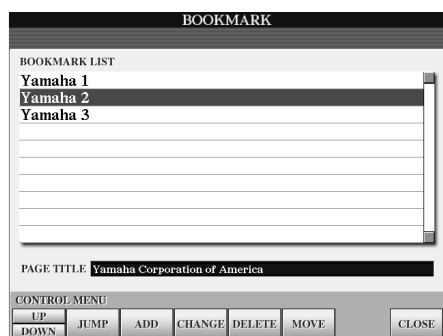

Close
Closes the Bookmark display and returns to the browser display.

Move
Changes the order of the bookmarks.
1. Select the bookmark you wish to move, then press the [MOVE] LCD button ([6] button).
The lower part of the display changes, letting you select the new position for the bookmark.
2. Select the intended position by pressing the [UP/DOWN] LCD button ([1] button).
3. Move the bookmark to the selected position by pressing the [EXECUTE] LCD button ([7] button).

Delete
Deletes the selected bookmark from the Bookmark list.

Changing names
Changes the name of the selected bookmark. Pressing the [CHANGE] LCD button ([4] button) calls up the display for entering characters. For details on entering characters, see page 199.

Add
Used when saving a bookmark (page 202).

Jump
Opens the web page of the selected bookmark.

Cursor up/down
Moves the selection position in the Bookmark list.

Changing the Home Page

In the default condition, the top page of the special Tyros2 website is automatically set to be the Home page for the browser. However, you can specify any desired page on the special Tyros2 website to be the Home page.

- ▶ **1** Open the page you wish to set as your new Home page.
- ▶ **2** Press the [SETTING] LCD button (lower [5] button) to call up the Internet Setting display.
- ▶ **3** Press the [TAB] button to select the BROWSER tab.

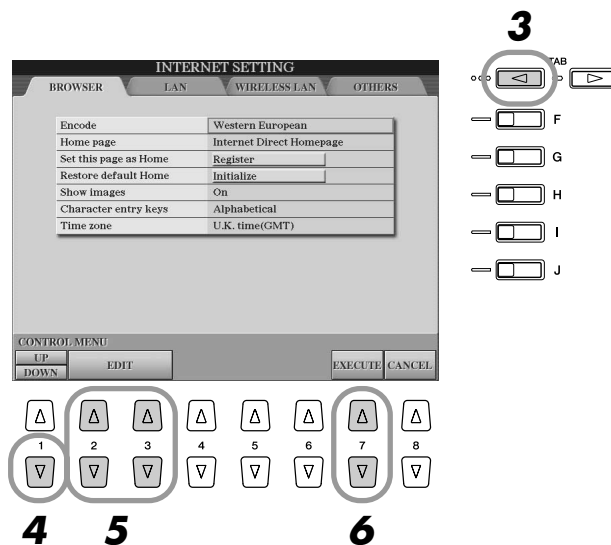

- ▶ **4** Press the [DOWN] LCD button (lower [1] button) to select the setting "Set this page as Home."
- ▶ **5** Use the [EDIT] LCD buttons ([2], [3] buttons) to actually set the selected page as your new Home page.
- ▶ **6** To return to the browser, press the [EXECUTE] LCD button ([7] button). To cancel, press the [CANCEL] LCD button ([8] button).

About the Internet Settings Display

From the Internet Settings display, you can make various settings related to the Internet connection, including preferences for the menus and displays. The Internet Settings display has four sub-displays: Browser, LAN, Wireless LAN, and Others.

Basic Procedure

- ▶ **1** Press the [SETTING] LCD button (lower [5] button) to call up the Internet Setting display.
- ▶ **2** Press the [TAB] buttons to select the desired display.
- ▶ **3** Select the desired item by pressing the [UP/DOWN] LCD button ([1] button).

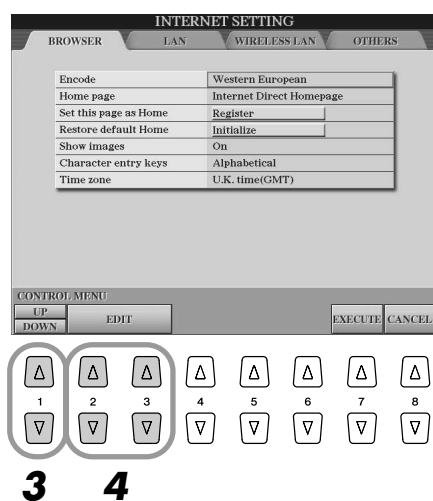

- ▶ **4** To call up the relevant Edit display, press the [EDIT] LCD buttons ([2], [3] buttons).
For some items, the Edit display may not be shown, but the setting or change may be executed.
- ▶ **5** Press the [UP/DOWN] LCD button ([2] button) to select the setting or change the value.
This can also be done by using the [DATA ENTRY] dial.

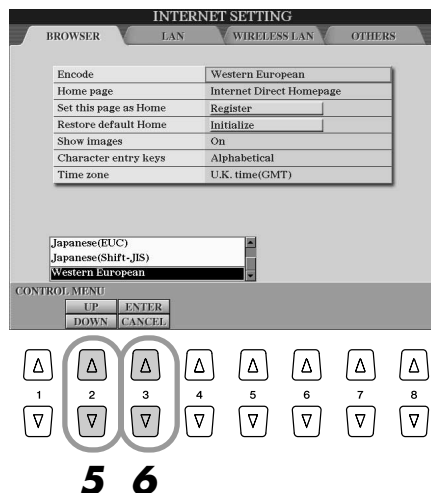

- ▶ **6** To execute the setting, press the [ENTER] LCD button (upper [3] button). To cancel, press the [CANCEL] LCD button (lower [3] button).

NOTE

- **Entering Characters**
When the character input display is opened, you can enter characters. (Refer to "Entering Characters" on page 199.)

- ▶ **7** To actually apply all settings changed in the Internet Settings display, press the [EXECUTE] LCD button ([7] button).
To cancel, press the [CANCEL] LCD button ([8] button).

■ **Browser**

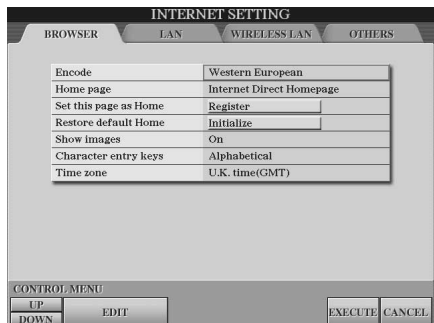

Encode	Selects the character code encoding for the browser.
Home Page	Shows and allows editing of the web page which is set as the home page.
Set this page as Home	For details, refer to “Changing the Home Page” on page 204.
Restore default Home	Restores the home page setting.
Show images	Image data and pictures in the web page are shown in the browser when this is set to on. Image data is not shown when this is set to off.
Character entry keys	This setting lets you select the character order of the virtual keyboard for entering characters. When this is set to “Alphabetical,” the keys are in alphabetical order. When this is set to “ASCII,” the keys are arranged as a conventional “QWERTY” keyboard.
Time zone	This determines the time setting for the browser.

■ **LAN**

Both the wired LAN and wireless LAN need to be set in this display.

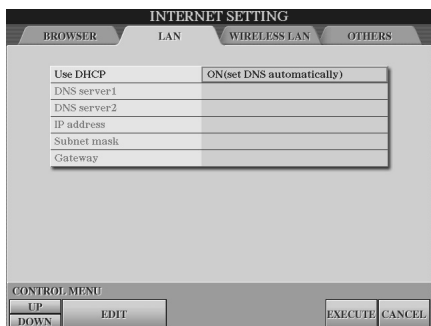

Make a written note of the settings here, in case you have to enter them again.

Use DHCP	
DNS server1	
DNS server2	
IP address	
Subnet mask	
Gateway	

Use DHCP	Determines whether or not DHCP is used. If your router is compatible with DHCP, select “ON.”
DNS server 1/DNS server 2	These determine the addresses of the primary and secondary DNS servers. These settings must be made when “Use DHCP” above is set to “ON (set DNS manually)” or “OFF.”
IP address/Subnet mask/Gateway	These settings are available only when DHCP is not used. The settings here are: IP address, subnet mask, and gateway server address. These settings must be made when “Use DHCP” above is set to “OFF.”

■ Wireless LAN

For a wireless LAN setup, make sure to set both the LAN settings (page 206) and the Wireless LAN settings below.

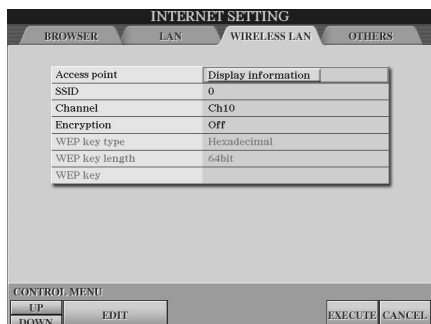

Make a written note of the settings here, in case you have to enter them again.

SSID	
Channel	
Encryption	
WEP key type	
WEP key length	
WEP key	

Access point	Select an access point from the access point list. When you select an access point from the list by using the [B]/[C] button, the SSID and channel are automatically set. If you select an encrypted access point (with key icon), enter the WEP key type, WEP key length and WEP key after exiting from the access point list.
SSID	Determines the SSID setting.
Channel	Determines the channel.
Encryption	Determines whether or not the data is encrypted.
WEP key type/WEP key length/WEP key	These settings are available only when Encryption above is enabled. These set the type and length of the encryption key.

■ Others

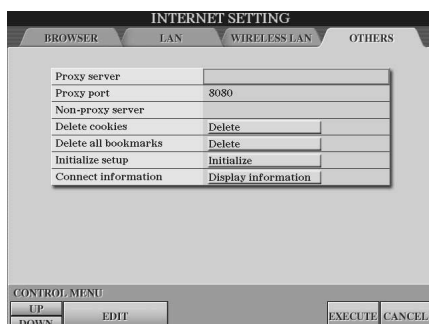

Proxy server/Proxy port/Non-proxy server	Determines the proxy server name, port number and the host name for the non-proxy server. The settings here are only necessary when using a proxy server. When using a non-proxy server, enter a separator (comma) between each server name.
Delete cookies	Deletes the contents of all saved cookies.
Delete all bookmarks	Deletes all saved bookmarks.
Initialize setup	Restores all settings in the Internet Settings displays to their defaults. See "Initializing Internet Settings" on page 208.
Connect information	Shows detailed information on the current connection.

Initializing Internet Settings

The settings of the Internet function are not initialized when using the Initialize operation of the Tyros2; Internet settings must be initialized separately, as explained here. Initializing will reset to the default values not only the settings of the browser, but also all settings you have made in the Internet Settings displays (except for the cookies and bookmarks), including those related to Internet connection.

- ▶ **1** Press the [SETTING] LCD button (lower [5] button) to call up the Internet Settings display.
- ▶ **2** Press the [TAB] button to select the OTHERS tab.
- ▶ **3** Press the [UP/DOWN] LCD button ([1] button) to select “Initialize.”

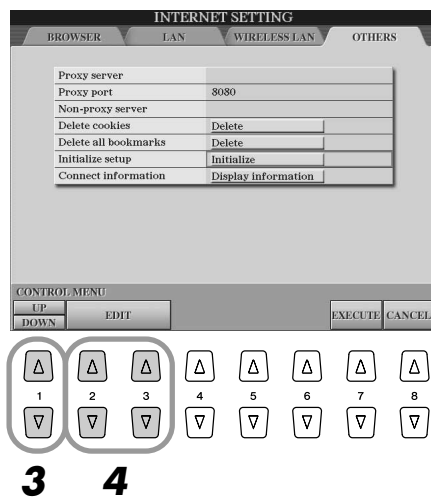

- ▶ **4** Use the [EDIT] LCD buttons ([2], [3] buttons) to initialize the Internet settings.

Delete cookies/bookmarks

Cookies and bookmarks are still remain after executing the initialize operation above.

To delete the cookies or bookmarks, use the appropriate operations in the OTHERS tab display (page 207).

NOTE

- Cookies contain personal information.

Glossary of Internet Terms

Access point	The wave relay device that connects terminals by the wireless LAN. Usually, this is referred to as the "Wireless LAN access point," but here it is simply called "access point" for this instrument.
Broadband	An Internet connection technology/service (such as ADSL and optical fiber) that allows for high-speed, high-volume data communication.
Browser	The software used to search for, access, and view web pages. For this instrument, this refers to the display that shows the contents of the web pages.
Cookie	A system that records certain information that the user transfers when visiting a website and using the Internet. The function is similar to a preference file in a conventional computer program, in that it "remembers" certain information such as your user name and password, so you don't have to re-enter the information each time you visit the site.
DHCP	This is a standard or protocol by which IP addresses and other low-level network configuration information can be dynamically and automatically assigned each time connection is made to the Internet.
DNS	A system that translates names of computers connected to a network to their corresponding IP addresses.
Download	Transferring data over a network, from a larger "host" system to a smaller "client" system's hard drive or other local storage device—much like copying files from your hard disk drive to a floppy disk. For this instrument, this refers to the process of transferring Song and other data from a website to the instrument.
Gateway	A system which links different networks or systems, and makes possible data transfer and conversion despite differing communications standards.
Home page	The first page shown when opening a browser and connecting to the Internet. This phrase is also used to mean the "front screen" or top page of a website.
Internet	A huge network made up of networks, the Internet allows high-speed data transfer among computers, mobile phones and other devices.
IP address	A string of numbers assigned to each computer connected to a network, and indicating the device's location on the network.
LAN	Short for Local Area Network, this is a data-transfer network that connects a group of computers at a single location (such as an office or home) by means of a special cable.
Link	A highlighted word, button or icon within a web page that, when clicked, opens another web page.
Modem	A device which connects and allows data transfer between a conventional telephone line and a computer. It converts the digital signals from the computer to analog audio for sending over the phone line, and vice versa.
NTP	Short for Network Time Protocol, a standard for setting the internal system clock of the computer over a network. For this instrument, the internal clock of the computer is used to specify the valid time/date for cookies and SSL.
Provider	A communications business that offers Internet connection services. In order to connect to the Internet, it is necessary to contract to a provider.
Proxy	A proxy server is a server that all computers on a local network have to go through before accessing information on the Internet. It intercepts all or designated requests to the real server to see if it can fulfill the requests itself. If not, it forwards the request to the real server. Proxy servers are used to improve performance and speed, and to filter requests, usually for security and to prevent unauthorized access to an internal network.
Router	A device for connecting multiple computer networks. For example, a router is necessary when connecting several computers in a house or office, and allow them to all access the Internet and share data. A router is usually connected between a modem and a computer, although some modems have a built-in router.
Server	A hardware system or computer used as a central point for a network, providing access to files and services.
Site	Short for "website," this refers to the group of web pages that are opened together. For example, the collection of web pages whose addresses begin with "http://www.yamaha.com/" is referred to as the Yamaha site.
SSID	This is an identification name for specifying a particular network over a wireless LAN connection. Communication is possible only between terminals with matching SSID names.
SSL	Short for Secure Sockets Layer, a standard for transmitting confidential data such as credit card numbers over the Internet.
Subnet mask	A setting used to divide a large-scale network into several smaller networks.
URL	Short for Uniform Resource Locator, a string of characters used to identify and link to specific websites and pages on the Internet. A complete URL usually starts with the characters "http://."
Web page	Refers to each individual page that makes up a website.
Wireless LAN	A LAN connection that allows data transfer through a wireless, cable-free connection.

MIDI

Built into the rear panel of the Tyros2 are two sets of MIDI terminals (MIDI IN A/B, MIDI OUT A/B), and a USB terminal. The MIDI Functions give you a comprehensive, powerful set of tools for expanding your music recording and performance possibilities. This section explains what MIDI is, and what it can do, as well as how you can use MIDI on your Tyros2.

What's MIDI

No doubt you have heard the terms “acoustic instrument” and “digital instrument.” In the world today, these are the two main categories of instruments. Let's consider an acoustic piano and a classical guitar as representative acoustic instruments. They are easy to understand. With the piano, you strike a key, and a hammer inside hits some strings and plays a note. With the guitar, you directly pluck a string and the note sounds. But how does a digital instrument go about playing a note?

● Acoustic guitar note production

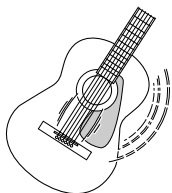

Pluck a string and the body resonates the sound.

● Digital instrument note production

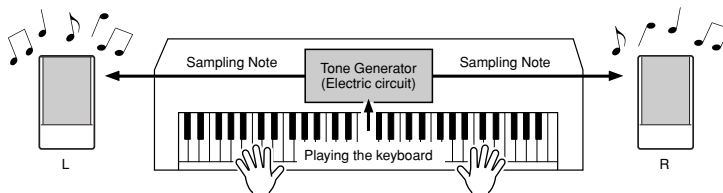

Based on playing information from the keyboard, a sampling note stored in the tone generator is played through the speakers.

As shown in the illustration above, in an electronic instrument the sampling note (previously recorded note) stored in the tone generator section (electronic circuit) is played based on information received from the keyboard. So then what is the information from the keyboard that becomes the basis for note production?

For example, let's say you play a “C” quarter note using the grand piano sound on the Tyros2 keyboard. Unlike an acoustic instrument that puts out a resonated note, the electronic instrument puts out information from the keyboard such as “with what voice,” “with which key,” “about how strong,” “when was it pressed” and “when was it released.” Then each piece of information is changed into a number value and sent to the tone generator. Using these numbers as a basis, the tone generator plays the stored sampling note.

● Example of Keyboard Information

Voice number (with what voice)	01 (grand piano)
Note number (with which key)	60 (C3)
Note on (when was it pressed) and note off (when was it released)	Timing expressed numerically (quarter note)
Velocity (about how strong)	120 (strong)

As described above, your keyboard performance and panel operations such as voice selection are handled as MIDI events. All the data of Style, Song, and Multi Pad played back or recorded consist of MIDI messages.

MIDI (Musical Instrument Digital Interface) allows electronic musical instruments to communicate with each other, by sending and receiving compatible Note, Control Change, Program Change and various other types of MIDI data, or messages. The Tyros2 can control a MIDI device by transmitting note related data and various types of controller data. The Tyros2 can be controlled by the incoming MIDI messages which automatically determine tone generator mode, select MIDI channels, voices and effects, change parameter values and of course play the voices specified for the various parts. MIDI messages can be divided into two groups: Channel messages and System messages.

Below is an explanation of the various types of MIDI messages which the Tyros2 can receive/transmit.

● Channel Messages

The Tyros2 is an electronic instrument that can handle 32 channels (16 channels x 2 ports). This is usually expressed as “it can play 32 instruments at the same time.” Channel messages transmit information such as Note ON/OFF, Program Change, for each of the 32 channels.

Message Name	Tyros2 Operation/Panel Setting
Note ON/OFF	Messages which are generated when the keyboard is played. Each message includes a specific note number which corresponds to the key which is pressed, plus a velocity value based on how hard the key is played.
Program Change	Voice selecting
Control Change	Volume, panpot (Mixing Console), etc.
Pitch Bend	Pitch Bend Wheel operation
After Touch	Messages which are generated when pressure is applied to a key after the notes are played.

● System Messages

This is data that is used in common by the entire MIDI system. System messages include messages like System Exclusive Messages that transmit data unique to each instrument manufacturer and Realtime Messages that control the MIDI device.

Message Name	Tyros2 Operation/Panel Setting
System Exclusive Message	Effect type settings (Mixing Console), etc.
Realtime Messages	Clock setting, Start/stop operation

MIDI channels

MIDI performance data is assigned to one of sixteen MIDI channels. Using these channels, 1–16, the performance data for sixteen different instrument parts can be simultaneously sent over one MIDI cable.

Think of the MIDI channels as TV channels. Each TV station transmits its broadcasts over a specific channel. Your home TV set receives many different programs simultaneously from several TV stations and you select the appropriate channel to watch the desired program.

MIDI operates on the same basic principle. The transmitting instrument sends MIDI data on a specific MIDI channel (MIDI Transmit Channel) via a single MIDI cable to the receiving instrument. If the receiving instrument's MIDI channel (MIDI Receive Channel) matches the Transmit Channel, the receiving instrument will sound according to the data sent by the transmitting instrument.

For example, several parts or channels can be transmitted simultaneously, including the style data (as shown at right).

As you can see, it is essential to determine which data is to be sent over which MIDI channel when transmitting MIDI data (page 215). The Tyros2 also allows you to determine how the received data is played back (page 216).

Though MIDI is designed to handle up to sixteen channels, the use of separate MIDI "ports" allows for even more. The Tyros2 has two MIDI ports, allowing simultaneous use of thirty-two channels.

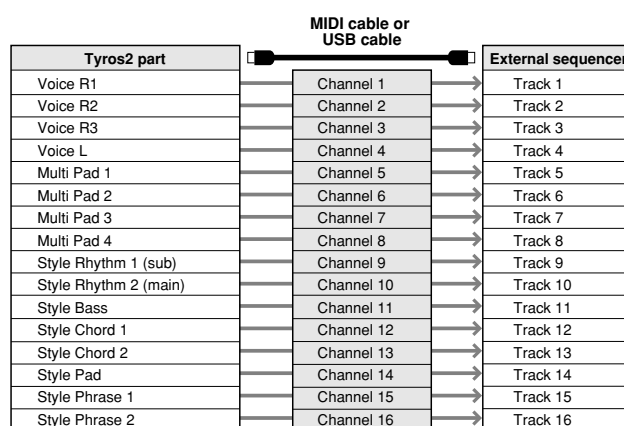
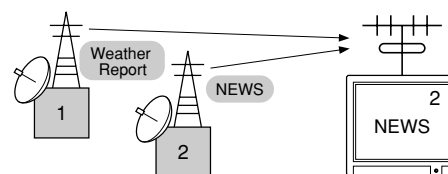

MIDI connection between the Tyros2 and other MIDI instruments

MIDI messages (events) described above are transmitted or received via two sets of MIDI terminals (MIDI A IN/OUT, MIDI B IN/OUT) or the USB connector.

- **MIDI IN** Receives MIDI data from another MIDI device. Two ports (A, B) are provided and each can receive MIDI messages of 16 channels.
- **MIDI OUT** Transmits the Tyros2's keyboard information as MIDI data to another MIDI device. Two ports (A, B) are provided and each can transmit MIDI messages of 16 channels.
- **USB** Transmits and receives MIDI data to and from a computer. Both MIDI ports are accessible over USB.

To transmit/receive MIDI data between two devices, a proper cable connection is needed. You can connect the Tyros2 to another device by MIDI cables (using the MIDI terminals) or by a USB cable (using the USB connectors). (See page 66.)

MIDI connection via MIDI cable

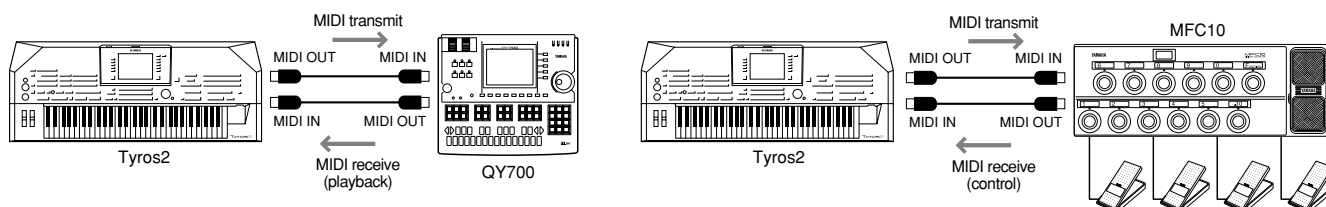

MIDI connection via USB cable

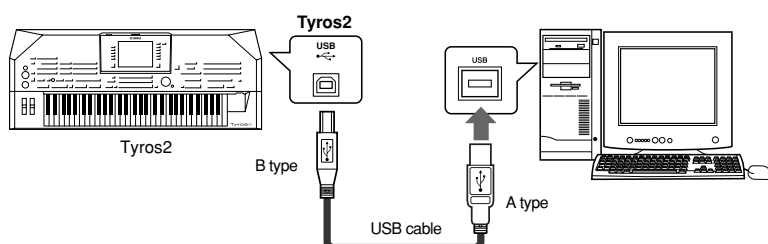

MIDI Data Compatibility

This section covers basic information on data compatibility: whether or not other MIDI devices can playback the data recorded by Tyros2, and whether or not the Tyros2 can playback commercially available song data or song data created for other instruments or on a computer. Depending on the MIDI device or data characteristics, you may be able to playback the data without any problem, or you may have to perform some special operations before the data can be played back. If you run into problems playing back data, please refer to the information below.

Sequence format

Song data is recorded and stored in a variety of different systems, referred to as “sequence formats.” Playback is only possible when the sequence format of the Song data matches that of the MIDI device.

● SMF (Standard MIDI File)

This is the most common sequence format. Standard MIDI Files are generally available as one of two types: Format 0 or Format 1. Many MIDI devices are compatible with Format 0, and most commercially available software is recorded as Format 0. The Tyros2 is compatible with both Format 0 and Format 1. Song data recorded on the Tyros2 is automatically recorded as SMF Format 0.

● ESEQ

This sequence format is compatible with many of Yamaha’s MIDI devices, including the Tyros2 series instruments. This is a common format used with various Yamaha software. The Tyros2 is compatible with ESEQ.

● XF

The Yamaha XF format enhances the SMF (Standard MIDI File) standard with greater functionality and open-ended expandability for the future. The Tyros2 is capable of displaying lyrics when an XF file containing lyric data is played.

● STYLE FILE

The Style File Format—SFF—is Yamaha’s original style file format which uses a unique conversion system to provide high-quality automatic accompaniment based on a wide range of chord types. The Tyros2 uses the SFF internally, reads optional SFF style disks, and creates SFF styles using the Style Creator function.

Voice allocation format

With MIDI, voices are assigned to specific numbers, called “program numbers.” The numbering standard (order of voice allocation) is referred to as the “voice allocation format.” Voices may not play back as expected unless the voice allocation format of the song data matches that of the compatible MIDI device used for playback.

● GM System Level 1

“GM System Level 1” is a standard specification that defines the arrangement of voices in a tone generator and its MIDI functionality, ensuring that data can be played back with substantially the same sounds on any GM-compatible tone generator, regardless of its manufacturer or model.

● GM System Level 2

“GM System Level 2” is a standard specification that enhances the original “GM System Level 1” and improves song data compatibility. It provides for increased polyphony, greater voice selection, expanded voice parameters, and integrated effect processing.

● XG

“XG” is a tone generator format that expands the voice arrangement of the “GM System Level 1” specification to meet the ever-increasing demands of today’s computer peripheral environment, providing richer expressive power while maintaining upward compatibility of data. “XG” greatly expands “GM System Level 1” by defining the ways in which voices are expanded or edited and the structure and type of effects. When commercially available song data bearing the XG logo is played back on a tone generator which bears the XG logo, you will enjoy a full musical experience that includes unlimited expansion voices and effect functions.

● GS

GS was developed by the Roland Corporation. In the same way as Yamaha XG, GS is a major enhancement of the GM specifically to provide more Voices and Drum kits and their variations, as well as greater expressive control over Voices and effects.

Preset MIDI settings (templates)

The Tyros2 gives you a set of comprehensive, flexible MIDI controls. It also gives you a set of ten pre-programmed templates that let you instantly and easily reconfigure the instrument to match your particular MIDI application or external device. Call up these templates from the [FUNCTION] → MIDI display (next page).

Template name	Descriptions
ALL PARTS	Transmits all parts including the keyboard parts (RIGHT 1, 2, 3, LEFT).
KBD & STYLE	Basically the same as "ALL PARTS" with the exception of how keyboard parts are managed. The right-hand parts are handled as a "UPPER" instead of RIGHT 1–3 and the left-hand part is handled as a "LOWER."
Master KBD1	In this setting, the Tyros2 functions as a "master" keyboard, playing and controlling one or more connected tone generators or other devices (such as a computer/sequencer).
Master KBD2	Basically the same as "Master KBD1" above, with the exception that Aftertouch messages are not transmitted.
Clock Ext.A	Playback or recording (Song, Style, Multi Pad, etc.) synchronizes with an external MIDI clock instead of the Tyros2's internal clock. This template is called up when you wish to set the tempo on the MIDI device connected to the Tyros2. Playback or Recording of the Tyros2 synchronizes with an external clock received via MIDI A.
MIDI Accord1	MIDI accordions allow you to transmit MIDI data and play connected tone generators from the keyboard and bass/chord buttons of the accordion. This template lets you play melodies from the keyboard and control style playback on the Tyros2 with the left-hand buttons.
MIDI Accord2	Basically the same as "MIDI Accord1" above, with the exception that the chord/bass notes you play with your left hand on the MIDI Accordion are recognized also as MIDI note events.
MIDI Pedal1	MIDI pedal units allow you play connected tone generators with your feet (especially convenient for playing single note bass parts). This template lets you play/control the chord root in style playback with a MIDI pedal unit (connected to MIDI B only).
MIDI Pedal2	This template lets you play the bass part for style playback by using a MIDI pedal unit (connected to MIDI B only).
MIDI OFF	No MIDI signals are sent or received.

Basic Procedure (Function MIDI)

1 Press the [FUNCTION] button.

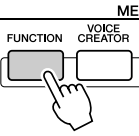

2 Select "MIDI."

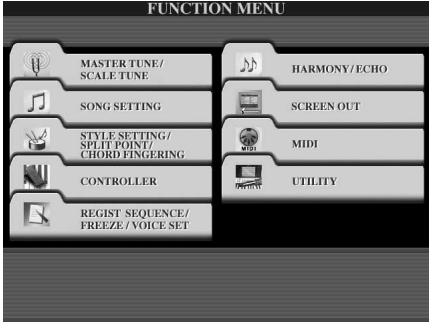

3 Select a MIDI template (page 213).



4 Press the [EDIT] LCD button to call up the display for setting the MIDI parameters. Here you can see and edit the detailed settings that correspond to the MIDI template selected in step #3.

5 As desired, set the MIDI parameters.

MIDI System Settings (page 215)

MIDI Transmit Settings (page 215)

MIDI Receive Settings (page 216)

Setting the Chord Root for Style Playback via MIDI receive (page 217)

Setting the Chord Type for Style Playback via MIDI receive (page 217)

Settings for a connected MFC10 MIDI Foot Controller (page 217)



6 Press the [EXIT] button to return to the MIDI template display.



7 Save the MIDI settings on the displays in step #5 to the USER page as a MIDI template.

MIDI System Settings

The explanations here apply when you call up the SYSTEM page in step #5 of the Basic Procedure on page 214.

Local Control.....

Turns the Local Control for each part on or off. When Local Control is set to “ON,” the keyboard of the Tyros2 controls its own (local) internal tone generator, allowing the internal voices to be played directly from the keyboard. If you set Local to “OFF,” the keyboard and controllers are internally disconnected from the Tyros2’s tone generator section so that no sound is output when you play the keyboard or use the controllers. For example, this allows you to use an external MIDI sequencer to play the Tyros2’s internal voices, and use the Tyros2 keyboard to record notes to the external sequencer and/or play an external tone generator.

Clock setting, etc.....

● CLOCK

Determines whether the Tyros2 is controlled by its own internal clock or a MIDI clock signal received from an external device. INTERNAL is the normal Clock setting when the Tyros2 is being used alone. If you are using the Tyros2 with an external sequencer, MIDI computer, or other MIDI device, and you want to synchronize it to that device, set this parameter to the appropriate setting: MIDI A, MIDI B, USB 1, or USB 2. Make sure that the external device is connected properly (e.g., to the Tyros2’s MIDI IN terminal), and that it is properly transmitting a MIDI clock signal.

● TRANSMIT CLOCK

Turns MIDI clock transmission on or off. When set to OFF, no MIDI clock or START/STOP data is transmitted even if song or style is played back.

● RECEIVE TRANSPOSE

Determines whether the Tyros2’s transpose setting (page 88) is applied to the note events the Tyros2 received via MIDI or not.

● START/STOP

Determines whether incoming FA (start) and FC (stop) messages affect song or style playback.

Message Switch.....

● SYS/EX.

The “Tx” setting turns MIDI transmission of MIDI system exclusive messages on or off.

The “Rx” setting turns MIDI reception and recognition of MIDI system exclusive messages generated by external equipment on or off.

● CHORD SYS/EX.

The “Tx” setting turns MIDI transmission of MIDI chord exclusive data (chord detect—root and type) on or off.

The “Rx” setting turns MIDI reception and recognition of MIDI chord exclusive data generated by external equipment on or off.

MIDI Transmit Settings

The explanations here apply when you call up the TRANSMIT page in step #5 of the Basic Procedure on page 214. This determines which parts will send MIDI data and over which MIDI channel the data will be sent.

Select the part for changing transmit settings. With the exception of the two parts below, see page 179 for details about the parts.

• UPPER

A keyboard part played on the right side of the keyboard from the split point for the voices instead of RIGHT 1, 2, and 3.

• LOWER

A keyboard part played on the left side of the keyboard from the split point for the voices instead of LEFT. This part is not affected by the on/off status of the [ACMP] button.

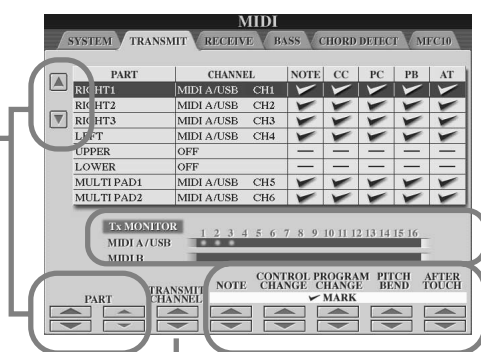

Select a channel via which the selected part will be transmitted.

Turns transmission of the specified data type (MIDI message) on or off. See below and page 132 for details.

NOTE

- If the same transmit channel is assigned to several different parts, the transmitted MIDI messages are merged to a single channel—resulting in unexpected sounds and possible glitches in the connected MIDI device.
- GS songs transmitted via MIDI are played back appropriately by using an XG sound source that supports the GS bank (76H and 77H).
- Write-protected songs cannot be transmitted even if the proper song channels 1–16 are set to be transmitted.

The dots corresponding to each channel (1-16) flash briefly whenever any data is transmitted on the channel(s).

■ MIDI messages which can be transmitted or received (recognized).....

The following MIDI messages can be set on the TRANSMIT/RECEIVE display.

- NOTE.....page 132
- CC (Control Change).....page 132
- PC (Program Change).....page 132
- PB (Pitch Bend).....page 132
- AT (Aftertouch).....page 132

MIDI Receive Settings

The explanations here apply when you call up the RECEIVE page in step #5 of the Basic Procedure on page 214. This determines which parts will receive MIDI data and over which MIDI channels the data will be received.

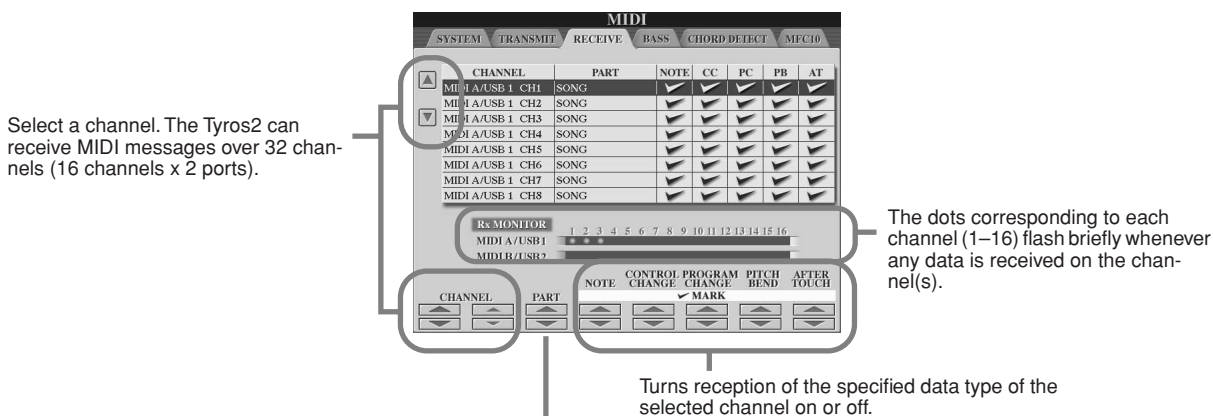

Determines the part to which the received MIDI messages of the selected channel are assigned. With the exception of the two parts below, see page 179 for details about the parts.

- **KEYBOARD**
The received note messages control the Tyros2's keyboard performance.
- **EXTRA PART1–4**
There are four parts specially reserved for receiving and playing MIDI data. Normally, these parts are not used by the instrument itself. The Tyros2 can be used as a 32-channel multi-timbral tone generator by using these four parts in addition to the parts (except for the microphone sound) described on page 179.

NOTE

To switch the desired Registration Memory via MIDI

- (1) Set "PART" to "KEYBOARD."
- (2) Send the following MIDI messages from an external device in the following sequence.

BANK MSB/LSB: Target Registration Memory Bank File number(*)

* File Number corresponds to the sorted order of the current drive. The value of the first file is 00H.

Program number (PC): Target [REGISTRATION MEMORY] button number (0–7)

Example: When selecting [REGISTRATION MEMORY] button number 4 of the 3rd Registration Memory Bank File, the values are: MSB/LSB/PC = 00H: 02H: 03H

■ MIDI transmission/reception via the USB terminal and MIDI terminals.....

The relationship between the MIDI terminals and the USB terminal which can be used for transmitting/receiving 32 channels (16 channels x 2 ports) of the MIDI messages is as follows:

● MIDI reception

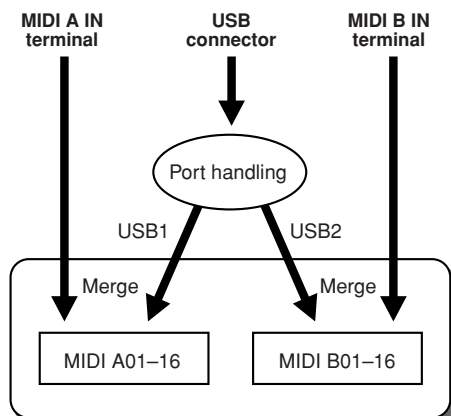

● MIDI transmission

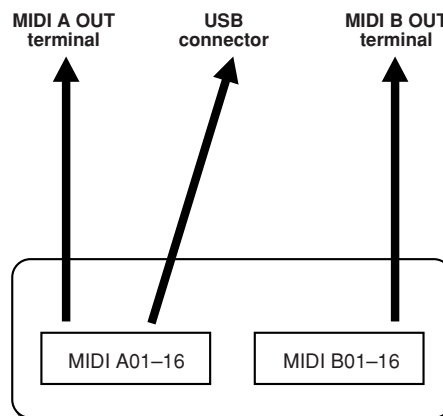

Setting the Chord Root for Style Playback via MIDI receive

The explanations here apply when you call up the BASS page in step #5 of the Basic Procedure on page 214. These settings let you determine the chord root for style playback, based on the note messages received via MIDI.

The note on/off messages received at the channel(s) set to “ON” are recognized as the root notes in the chord section. The root notes will be detected regardless of the [ACMP] on/off and split point settings. When several channels are simultaneously set to “ON,” the root note is detected from merged MIDI data received over the channels.

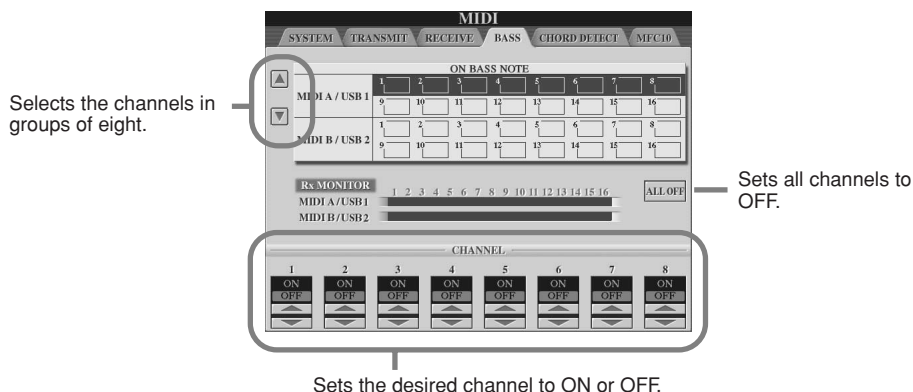

Setting the Chord Type for Style Playback via MIDI receive

The explanations here apply when you call up the CHORD DETECT page in step #5 of the Basic Procedure on page 214. These settings let you determine the chord type for style playback, based on the note messages received via MIDI.

The note on/off messages received at the channel(s) set to “ON” are recognized as the chord notes in the chord section. The chords to be detected depend on the fingering type. The chord types will be detected regardless of the [ACMP] on/off and split point settings. When several channels are simultaneously set to “ON,” the chord type is detected from merged MIDI data received over the channels.

The operation procedure is basically the same as that of the BASS display above.

MFC10 Settings

The explanations here apply when you call up the MFC10 page in step #5 of the Basic Procedure on page 214.

By connecting an optional MFC10 MIDI Foot Controller to the Tyros2, you can conveniently control a wide range of operations and functions by using your feet—perfect for changing settings and controlling the sound while you perform live. Different functions can be assigned to each of the footswitches and up to five foot controllers (optional) can be connected to the MFC10, for additional sound-shaping possibilities.

To assign the desired functions to the appropriate footswitches/foot controllers on the Tyros2, select [FUNCTION] → MIDI → EDIT → MFC10. Two settings (below) can be made from this display.

- Each footswitch (F00–F29) on the MFC10 sends a note number to the Tyros2, and the Tyros2 determines how it responds to (which function is executed by) that note number.
- Each foot controller on the MFC10 sends control change messages over a specific control change number to the Tyros2, and the Tyros2 determines how it responds to (which parameter is changed by) that control change number.

▶ 1 Connect the MIDI IN terminal of the MFC10 to one of the MIDI OUT terminals of the Tyros2 by using a MIDI cable.

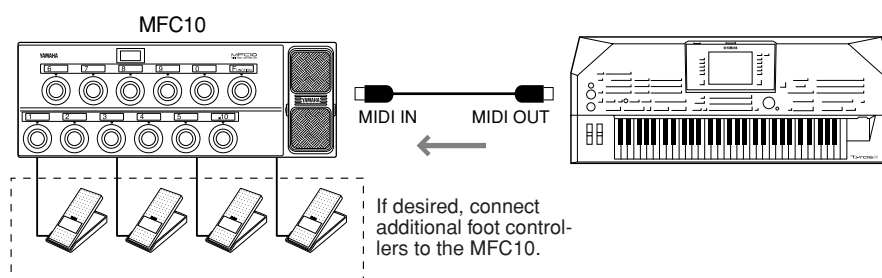

NOTE

- Do not connect the MIDI OUT terminal of the MFC10 to the MIDI IN of the Tyros2 in this step.

- ▶ **2** Set the MFC10 to the normal mode and turn the [FUNCTION] lamp of the MFC10 on.
- ▶ **3** Perform steps #1 through #5 of the Basic Procedure on page 214 to call up the MFC10 display.
- ▶ **4** Set the parameters on this display as desired and press the [SEND MFC10 SETUP] LCD button to send the settings here to the MFC10.

Select "FOOT SWITCH" or "FOOT CONTROLLER."

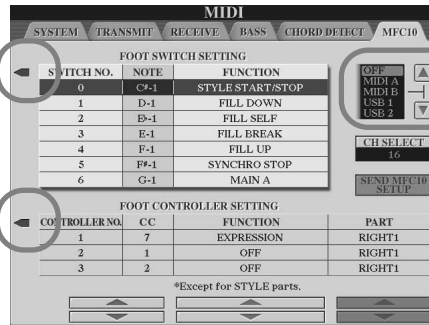

Select a footswitch number (F00–F29) or a foot controller number (1–5) to which the function is assigned. Please note that a note number is assigned to each footswitch and a control change number is assigned to each foot controller beforehand and you cannot change the settings.

NOTE

- See page 189 for details about the functions which can be assigned to the footswitch or foot controller.

Determines the function assigned to the footswitch (actually the note number), or the function assigned to the foot controller (actually the control change number).

Determines the part to which the function assigned to the foot controller in the row is applied.

Determines the MIDI port which is to be used when communicating with the MFC10. Here, the USB port (USB1, USB2) can be selected even though the MFC10 does not have the USB connector. This is because the computer can be used instead of the MFC10. (The computer can transmit the data equivalent to the data the MFC10 transmits to the Tyros2. For details, see the bottom of this page.)

Determines the MIDI channel which is to be used when communicating with the MFC10.

Transmit the settings on this display to the MFC10.

NOTE

- Actually the pair of the footswitch number and the note number, the pair of the foot controller number and the control change number, and the MIDI channel for communication set above are transmitted to the MFC10.

- ▶ **5** Disconnect the MIDI cable from the Tyros2 and the MFC10, and connect the MIDI OUT terminal of the MFC10 to the MIDI IN terminal of the Tyros2 according to the setting above by using the MIDI cable.

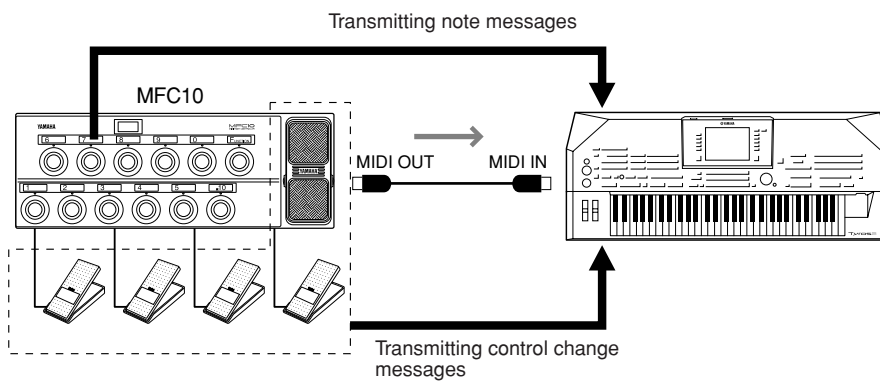

NOTE

- Do not connect the MIDI IN terminal of the MFC10 to the MIDI OUT of the Tyros2 in this step.

- ▶ **6** Operate the MFC10 to confirm whether you can properly control the Tyros2 from the MFC10 as set in step #4.
- ▶ **7** Go back to the MIDI template selection display and save the settings above to the User drive if necessary.

■ Using a computer or another MIDI instrument instead of the MFC10.....

The following two settings on the [FUNCTION] → MIDI → EDIT → MFC10 display can be saved not to the MFC10 but to internal memory (flash ROM) in the Tyros2 as a MIDI template.

- Note number/Tyros2 function assignment pairs
- Control change number/Tyros2 parameter change assignment pairs

If you are not using an MFC10, you can have note numbers and control change messages from any other appropriate MIDI device (such as a computer, sequencer or master keyboard) control the Tyros2. Make sure to set the appropriate channel in this display for control by the external device.

Appendix

Installing the Optional Speakers

Make sure that you have all of the parts below, included in the TRS-MS02 speaker package.

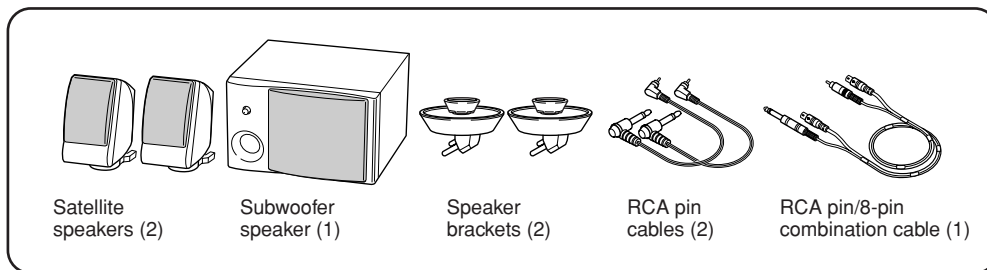

- ▶ **1** Turn the Tyros2's power off, and disconnect the AC power cord. Also, make sure to disconnect the keyboard from any other external devices.
- ▶ **2** Insert the two speaker brackets to the rear panel of the Tyros2.



NOTE

- Either bracket can be fastened to either location.

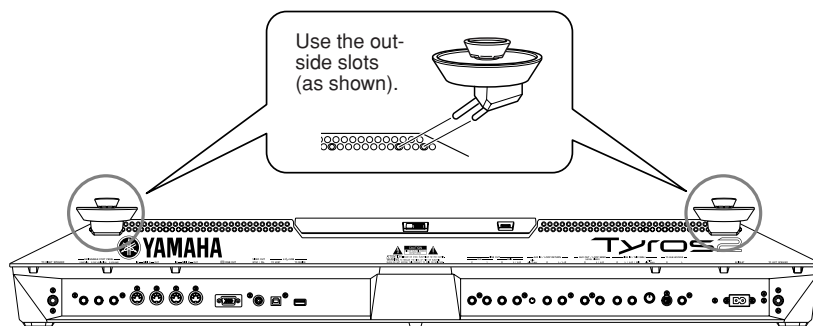

- ▶ **3** Fasten the satellite speakers to the left and right brackets.

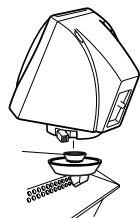

Place the speaker on the bracket.

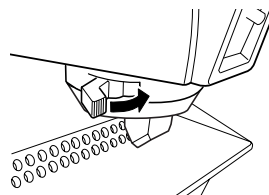

Adjust the direction of the speaker as desired, then fasten it securely to the bracket.



NOTE

- Either speaker can be placed on either bracket.
- If you want to change the direction of the satellite speaker, unfasten it from the bracket by rotating the lever, then adjust the speaker position as desired, and fasten it to the bracket again.

- ▶ **4** Use the RCA pin cables to connect the speakers to the respective outputs on the Tyros2.



NOTE

- Either cable can be used for either location.

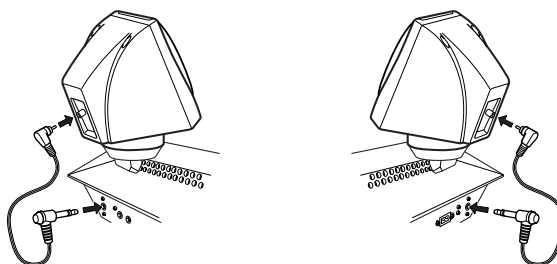

- ▶ **5** Use the RCA pin/8-pin combination cable to connect the subwoofer speaker to the respective outputs on the Tyros2.

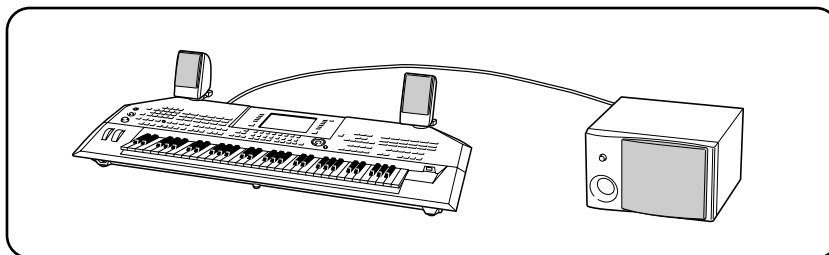
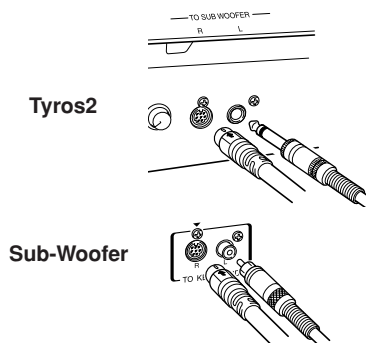

- ▶ **6** Connect the power plugs of the Tyros2 and the subwoofer to an appropriate AC outlet.
- ▶ **7** First, set the volume controls (**MASTER VOLUME** on the Tyros2 and **BASS** on the subwoofer) to minimum. Finally, turn on the power of the subwoofer, then the Tyros2.

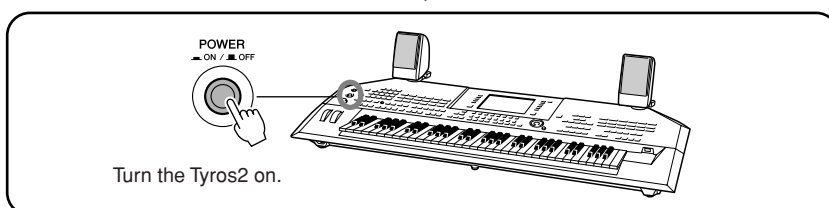
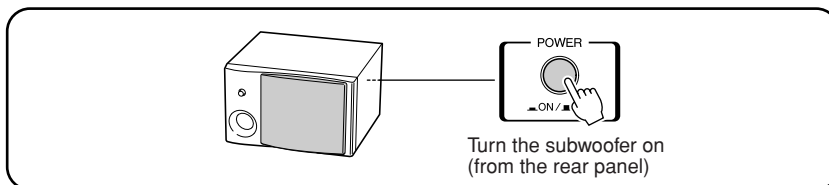
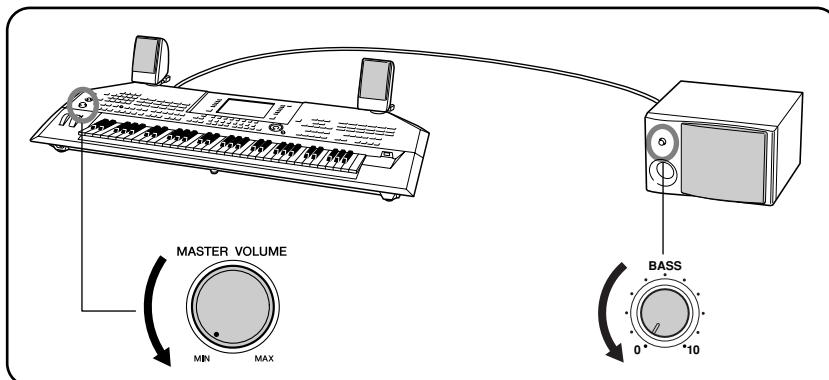

- ▶ **8** Adjust the volume controls (**MASTER VOLUME** on the Tyros2 and **BASS** on the subwoofer) to appropriate levels.

Installing an Optional Hard Disk

By installing an optional hard disk drive to the Tyros2, you can vastly expand the data storage capacity—letting you use the Hard Disk Recorder function or create a large library of your important data. The hard disk used must be a 2.5-inch IDE-compatible; however, not all such drives may be installable.

⚠ WARNING

- Before beginning installation, switch off the power to the Tyros2 and connected peripherals, and unplug them from the power outlet. Then remove all cables connecting the Tyros2 to other devices. (Leaving the power cord connected while working can result in electric shock. Leaving other cables connected can interfere with work.)
- Be careful not to drop any screws inside the instrument during installation (this can be prevented by keeping the optional units and cover away from the instrument while attaching). If this does happen, be sure to remove the screw(s) from inside the unit before turning the power on. Loose screws inside the instrument can cause improper operation or serious damage. If you are unable to retrieve a dropped screw, consult your Yamaha dealer for advice.
- Install the optional units carefully as described in the procedure below. Improper installation can cause shorts which may result in irreparable damage and pose a fire hazard.
- Do not disassemble, modify, or apply excessive force to board areas and connectors on optional hard disk units. Bending or tampering with boards and connectors may lead to electric shock, fire, or equipment failures.

⚠ CAUTION

- It is recommended that you wear gloves to protect your hands from metallic projections on optional units and other components. Touching leads or connectors with bare hands may cause finger cuts, and may also result in poor electrical contact or electrostatic damage.
- Handle the optional hard disk unit with care. Dropping or subjecting them to any kind of shock may cause damage or result in a malfunction.
- Be careful of static electricity. Static electricity discharge can damage the IC chips on the hard disk or the instrument. Before you handle the optional hard disk, to reduce the possibility of static electricity, touch the metal parts other than the painted area or a ground wire on the devices that are grounded.
- Do not touch the exposed metal parts in the circuit board. Touching these parts may result in a faulty contact.
- Be careful not to misplace any of the screws since all of them are used.
- Do not use any screws other than what are installed on the instrument and included.

🔧 NOTE

- Hard disk drives thicker than 12.7 mm cannot be installed to the Tyros2.
 - For information on the hard disk recommendations, ask your nearest Yamaha representative or an authorized distributor listed at the end of this owner's manual. Install a hard disk at your own risk. Yamaha will not be held responsible for any damage or injury resulting from improper installation or the use of a hard disk other than one of the types recommended by Yamaha.
- <http://music.yamaha.com/tyros2>

Before following the steps below, make sure you have an appropriate hard disk drive, Phillips screwdriver and the included four screws.

- ▶ **1** Turn the Tyros2's power off, and disconnect the AC power cord. Also, make sure to disconnect the keyboard from any other external devices.
- ▶ **2** Turn the Tyros2 face down on a blanket or some soft surface, giving you direct access to the bottom of the instrument.

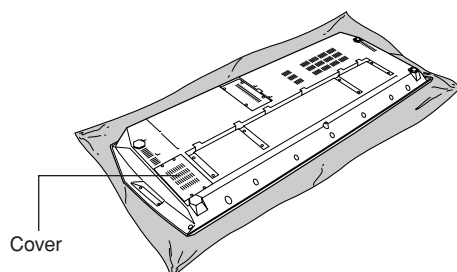

- ▶ **3** Remove the four screws from the cover.

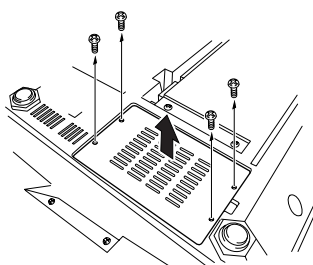

- ▶ **4** Remove the screw from the hard disk cover inside.

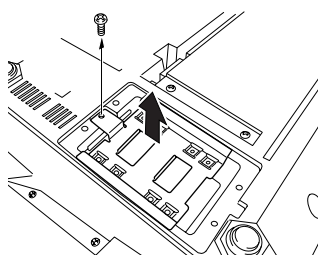

- ▶ **5** Attach the hard disk unit to the hard disk cover using the included four screws.

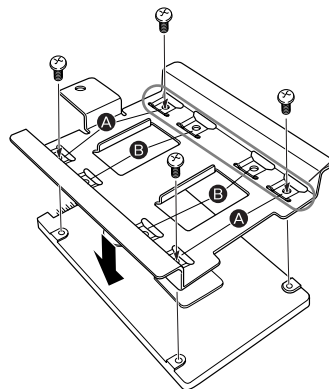

You should tighten these two screws first.

Make sure the bottom of the hard disk is facing up. Depending on the type of hard disk drive you plan to install, select holes (A) or holes (B) to attach the hard disk drive.

* Holes (A) are used in this illustration.

- ▶ **6** Replace the hard disk drive and cover (included with the hard disk) by fitting it into the Tyros2 as shown in the illustration.

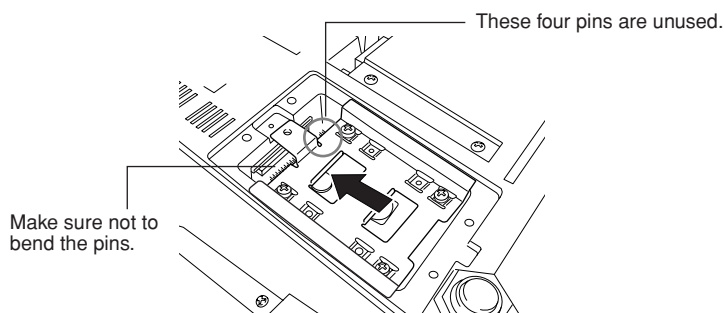

- ▶ **7** Attach the hard disk cover with the screw removed in step #4.

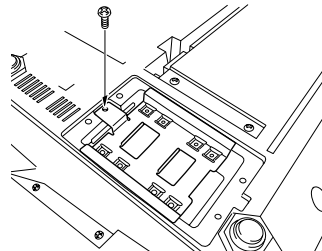

- ▶ **8** Replace the cover and attach it with the four screws removed in step #3.

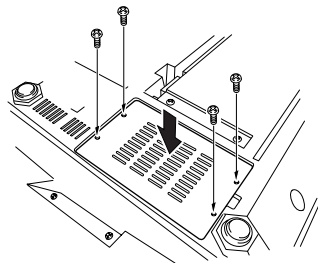

- ▶ **9** Check that the installed hard disk is functioning properly.

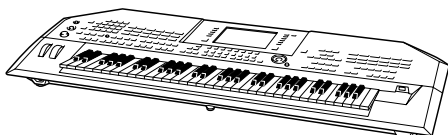

If the HD drive tab appears on the Open/Save display, the hard disk is OK. If the drive has multiple partitions, these will be shown as different HD drive tabs in the display.

NOTE

- If you have installed the hard disk that was once used for the PSR-9000/9000Pro/Tyros and turn the Tyros2's power on, you can immediately view the files on the hard disk and use the song files from the PSR-9000/9000Pro/Tyros. However, to properly use the style, Multi Pad, and Registration Memory files from the PSR-9000/9000Pro/Tyros, you will need to convert the data using a computer and the File Converter software (available for free download on the Tyros2 website).

Installing the Optional DIMMs

Installing optional DIMMs to the Tyros2 allows you to save large amounts of voice data created by the Voice Creator function. This section explains how to install DIMM memory modules to the Tyros2.

⚠ WARNING

- Before beginning installation, switch off the power to the Tyros2 and connected peripherals, and unplug them from the power outlet. Then remove all cables connecting the Tyros2 to other devices. (Leaving the power cord connected while working can result in electric shock. Leaving other cables connected can interfere with work.)
- Be careful not to drop any screws inside the instrument during installation (this can be prevented by keeping the optional units and cover away from the instrument while attaching). If this does happen, be sure to remove the screw(s) from inside the unit before turning the power on. Loose screws inside the instrument can cause improper operation or serious damage. If you are unable to retrieve a dropped screw, consult your Yamaha dealer for advice.
- Install the optional units carefully as described in the procedure below. Improper installation can cause shorts which may result in irreparable damage and pose a fire hazard.

⚠ CAUTION

- Do not touch the exposed metal parts in the circuit board. Touching these parts may result in a faulty contact.
- Be careful not to misplace any of the screws since all of them are used.
- Be careful of static electricity. Static electricity discharge can damage the DIMMs or the instrument. Before you handle the DIMMs, to reduce the possibility of static electricity, touch some unpainted metal surface or a ground wire on a device that is grounded.
- Do not use any screws other than what are installed on the instrument.

■ Compatible DIMMs

The Tyros2 does not necessarily support all commercially available DIMMs. Yamaha cannot guarantee operation of DIMMs that you purchase. Before purchasing DIMMs, please consult your Yamaha dealer, or an authorized Yamaha distributor (see list at end of the Owner's Manual) for advice, or see the following page:

<http://music.yamaha.com/tyros2>

■ DIMM Type and DIMM Configuration

- Yamaha recommends that you purchase DIMMs that conform to the JEDEC* standard. Please be aware, however, that conformance to this standard does not constitute a guarantee that the DIMMs will operate correctly on the Tyros2.
* JEDEC (Joint Electron Device Engineering Council) sets standards for terminal configurations within electronic devices.
- Use only 168-pin DIMMs of 64, 128, 256 or 512 MB capacity (synchronized DRAM; PC100 or PC133).
- Use only DIMMs that have a height 38.2 mm or less.
- When installing DIMMs, make sure to install them in a matched pair of the same capacity. You cannot install only one module and leave the second memory socket open. Also make sure each DIMM in the pair is of the same manufacturer and the same type. DIMMs of different makers and configurations may not work together.
- When purchasing DIMMs, make sure that the DIMM design does not utilize more than 18 memory chips per module. (DIMMs comprised of more than 18 chips do not operate correctly on the Tyros2.)

■ DIMM Installation

Before following the steps below, make sure you have appropriate DIMMs and a Phillips screwdriver.

- ▶ **1** Turn the Tyros2's power off, and disconnect the AC power cord. Also, make sure to disconnect the keyboard from any other external devices.
- ▶ **2** Turn the Tyros2 face down on a blanket or some soft surface, giving you direct access to the bottom of the instrument.

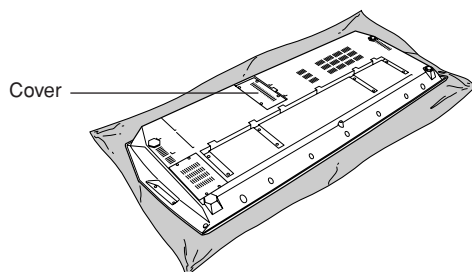

- ▶ **3** Remove the four screws from the cover.

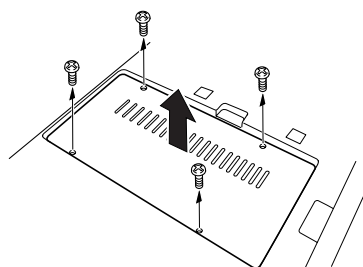

▶ **4** Insert the two DIMMs into the DIMM sockets.

168-pin DIMMs

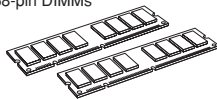

Location for DIMM installation

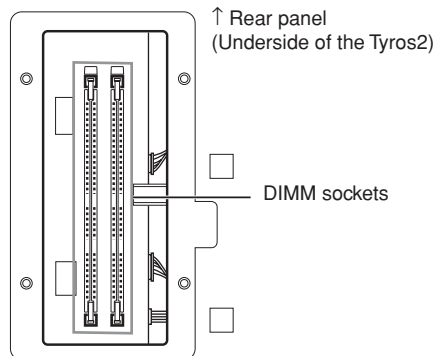

Installing the DIMM modules to the sockets

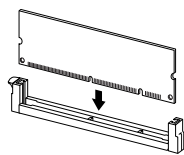
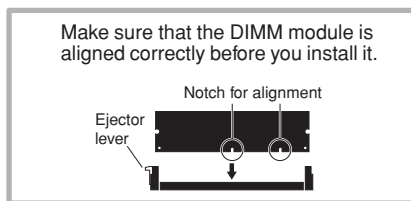

Insert the DIMM vertically in the socket, aligning the notches to the corresponding protrusions.

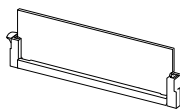

Press it in firmly until it "snaps" or locks in place.

▶ **5** Re-install the cover you removed in step #3, in reverse order.

▶ **6** Check that the installed DIMMs are functioning properly.

Set the Tyros2 right-side up, and connect the power cord to the rear-panel AC INLET jack and an AC outlet. Turn on the power and check the WAVE RAM in the PROPERTY pop-up of the Voice Creator function (page 103). If the DIMMs have been installed properly, the appropriate available memory size is indicated in the display.

■ **Removing DIMMs**

Press the ejector lever until the DIMM unlocks.

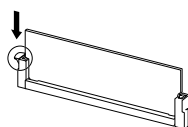

Pull the DIMM vertically out of the socket.

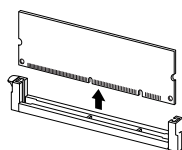

Troubleshooting

PROBLEM	POSSIBLE CAUSE/SOLUTION
When using a mobile phone, noise is produced.	Using a mobile phone in close proximity to the Tyros2 may produce interference. To prevent this, turn off the mobile phone or use it further away from the Tyros2.
No sound results.	<ul style="list-style-type: none"> • The RIGHT 1/RIGHT 2/RIGHT 3/LEFT voice volume settings on the BALANCE pop-up window could be set too low. Make sure the voice volumes are set at appropriate levels (page 36). • The Local Control function could be turned off. Make sure Local Control is turned on (page 215). • The [MASTER VOLUME] controls or foot volume are turned all the way down. Set the [MASTER VOLUME] controls and foot volume to a reasonable listening level. • Are the desired keyboard parts turned on? ([PART ON/OFF] button—page 80) • Are the desired parts or channels turned on? ([CHANNEL ON/OFF] button—page 37) • A pair of headphones is plugged into the PHONES jack. Unplug the headphones. • A plug is inserted in the LOOP SEND jacks. Unplug the LOOP SEND jacks. • Is the Footswitch connected to the appropriate connector (page 16)? • The [FADE IN/OUT] button (page 154) is on and has reached the end of its duration, muting the sound. Press the [FADE IN/OUT] button so that its indicator goes out. • Check whether the external speaker is connected properly. • Has an empty voice been selected from the Custom Voice Bank (page 102) or is the link to the Custom Voice Bank broken (page 108)?
The voice selected from the Open/Save display will not be sounded.	Check whether or not the selected part is turned on (page 80).
Not all simultaneously-played notes sound.	You are probably exceeding the maximum polyphony of the Tyros2. The Tyros2 can play up to 128 notes at the same time—including voice RIGHT 2, voice RIGHT 3, voice LEFT, style, song, and multi pad notes. When the maximum polyphony is exceeded, the earliest played notes will stop sounding, letting the latest played notes sound. This is referred to as “last-note priority.”
Style playback seems to “skip” when the keyboard is played.	
The style or song does not play back even when pressing the [START/STOP] or [PLAY/PAUSE] button.	Make sure the MIDI clock is set to “INTERNAL” (page 215).
The Multi Pads do not play back, even when one of the MULTI PAD buttons is pressed.	
The style does not start, even when Synchro Start is in standby condition and a key is pressed.	You may be trying to start style by playing a key in the right-hand range of the keyboard. To start the style with Synchro Start, make sure to play a key in the left-hand (chord) range of the keyboard.
Only the rhythm channel of style plays.	Make sure the [ACMP] is turned on.
Certain notes sound at the wrong pitch.	Make sure that the scale tuning value for those notes is set to “0” (page 187).
Style chords are recognized regardless of the split point or where chords are played on the keyboard.	Check whether the fingering mode is set to “Full Keyboard” or not. If the Full Keyboard fingering mode is selected, chords are recognized over the entire range of the keyboard, irrespective of the split point setting.
Song playback does not start.	<ul style="list-style-type: none"> • In the case a song to which write-protect has been applied (“Prot. 2 Edit” is shown at the upper left of the song name), the original file may not be in the same folder. It cannot be played back unless the original file (showing “Prot.2 Orig” at the upper left of the song name) is in the same folder. • In case of a song to which write-protect has been applied (“Prot. 2 Edit” is shown at the upper left of the song name), the original file name may have been changed. Rename the file with the original file name (so that “Prot.2 Orig” is shown at the upper left of the song name). • In case of a song to which write-protect has been applied (“Prot. 2 Edit” is shown at the upper left of the song name), the file icon may have been changed. songs to which write-protect has been applied cannot be played back when the file icon of the original has been changed. • MIDI Clock may be set to “EXTERNAL.” Make sure this is set to “INTERNAL” (page 215).
An audio song cannot be copied or cut.	The audio song file name (which contains the file path, internally) may be too long. Shorten the song name or copy/paste to an upper folder level.
An audio song cannot to be selected in the Playlist, even when it contains data.	If you change the file icon after adding to the Playlist, the song cannot be recognized from the Playlist. Add the file to the list again.

PROBLEM	POSSIBLE CAUSE/SOLUTION
In the Hard Disk Recorder function, an error message appears and audio cannot be recorded to the installed hard disk drive.	The data on the hard disk drive is fragmented and cannot be used as is. Since there is no Defrag function in the Hard Disk Recorder, the drive can only be defragmented by formatting it. To do this, first back up the data to a computer by using the USB storage mode (page 67), then format the drive, and finally copy the data back to the drive (using the USB storage mode again). Performing this copy/restore operation effectively defragments the drive, allowing you to use it again.
The Vocal Harmony effect sounds distorted or out-of-tune.	Your vocal microphone may be picking up extraneous sounds, such as the style sound from the Tyros2. In particular, bass sounds can cause mistracking of the Vocal Harmony. To remedy this: <ul style="list-style-type: none"> • Sing as closely to the microphone as possible. • Use a directional microphone. • Turn down the MASTER VOLUME, style volume, or song volume control. • Separate the microphone from the external speakers as much as possible. • Cut the Low band via the 3 Band EQ function in the MIC SETUP display (page 177).
When a voice is changed, the previously selected effect is changed.	This is normal, each voice has its own suitable preset values which are automatically recalled when the corresponding Voice Set parameters are turned on (page 188).
There is a slight difference in sound quality between notes played on the keyboard.	This is normal and is a result of the Tyros2's sampling system.
Some voices have a looping sound.	
Some noise or vibrato is noticeable at higher pitches, depending upon the voice.	
Some voices jump an octave in pitch when played in the upper or lower registers.	Some voices have a pitch limit which, when reached, causes this type of pitch shift. This is normal.
The style chord does not change even when a different chord is played or the chord is not recognized.	<ul style="list-style-type: none"> • Are you sure you're playing on the left-hand section of the keyboard? • You may be using single-finger type fingering (page 153).
The displayed disk free area value does not coincide with the actual value.	The displayed value is an approximate value.
Appropriate harmony notes are not produced by the Vocal Harmony feature.	Make sure you are using the appropriate method to specify the harmony notes for the current Vocal Harmony mode. See page 178.
The voice produces excessive noise.	Certain voices may produce noise, depending on the Filter (Harmonic Content/Brightness) or EQ settings of the Mixing Console Filter. This is unavoidable due to the sound generation and processing system of the Tyros2. To avoid noise, change the above mentioned settings.
The sound is distorted or noisy.	<ul style="list-style-type: none"> • The MASTER VOLUME control may be turned up too high. • This may be caused by the effects. Try cancelling all unnecessary effects, especially distortion-type effects. • Some filter resonance settings in the Voice Set display can result in distorted sound. • Is the gain of the Low band set too high in the Master EQ display (Mixing Console—page 184)?
A strange “flanging” or “doubling” sound occurs.	<ul style="list-style-type: none"> • Are the RIGHT 1 and RIGHT 2 parts set to “ON”, for example, and both parts set to play the same voice? • If you are routing the MIDI OUT on the Tyros2 to a sequencer and back to the MIDI IN, you may want to set Local Control (page 215) to “off” to avoid MIDI “feedback.”
The sound is slightly different each time the keys are played.	
The Main display does not appear even when turning the power on.	This may occur if a hard disk has been installed to the Tyros2. Installation of some hard disk units may result a long interval between turning the power on and appearance of the Main display.
The function assigned to the pedal does not operate correctly.	You can assign some functions to the pedal—punch in/out of Song/Hard Disk Recorder (pages 122, 143), Registration Sequence (page 173) and many functions from the Function display (page 189). If you assign multiple functions to the pedal, the priority is: Punch in/out of Song or Hard Disk Recorder > Registration Sequence > Functions

Glossary

A

Auto Accompaniment (Style playback)

A function that generates pre-programmed rhythm, bass and chord backing in response to specific notes/chords played (or received via MIDI).

C

Chorus

One of the Effect types.

Depending on the particular chorus type and parameters, this can make a voice sound “larger,” as if several identical instruments were playing in unison, or it can give a voice greater warmth and depth.

Clock

[1]

A unit of note resolution for MIDI Sequence data.

The sequencer determines the playback position of the Song or Pattern (MIDI sequence data) by using the following three parameters: Measure, Beat, and Clock.

[2]

Also referred to as “MIDI Clock,” defined as System Real-time Message in MIDI. This message is transmitted with a fixed interval (24 times per 1/4 note) to synchronize connected MIDI instruments.

On MIDI Sequencers, you can select whether the instrument’s internal clock will be used as the Timing Clock, or external Timing Clock messages received via MIDI IN will be used.

Control Change

A set of MIDI Channel messages that allow for control of a wide variety of sound parameters, including modulation, pan, volume, expression, brightness, effect depth, and others.

These can be adjusted using physical controllers, such as the Modulation Wheel and the Foot Controller.

D

Depth

Refers to the amount or degree to which a parameter setting changes the original sound.

E

Effect

On the Tyros2, an “Effect” is a processing block that alters the sound output from the tone generator block of the instrument, using DSP (Digital Signal Processing) circuitry to change the sound in various ways. The Tyros2 provides two types of effects: the DSP effects described above (such as Reverb, Chorus, DSP and DSP variation) and other effects (such as Harmony/Echo, Initial Touch, Sustain, and Poly/Mono).

Event List

A useful Song/Style/Multi Pad Creator tool that arranges all events in a song in chronological order (in measures, beats, clocks), and allows you to make detailed changes to those events.

F

Factory Reset

Refers to the original, factory-programmed settings of User drive memory, loaded to the instrument before it is shipped.

Flash ROM

ROM that can be overwritten allowing you to store your own original data, unlike conventional ROM.

G

Gate Time

In sequence recording, this determines the actual length of time a note sounds.

When entering the note events in Step Recording of the MIDI sequencer, Gate time is determined as a percent value of the step time. A setting of approximately 50% produces a staccato sound, values between about 80% and 90% produce normal note length, and a value of 100% will produce a slur.

L

Left-hand section of the keyboard

The section of keys to the left of the split point. Besides being used to play the LEFT voice, they can also be used to indicate/play chords for style playback as well as the Harmony and Vocal Harmony effects.

LFO

An abbreviation for low frequency oscillator, which generates a low frequency signal on the tone generator block. The signal from the LFO can be used to modulate the pitch, filter, and amplitude. Modulating the pitch produces a vibrato effect, modulating the filter produces a wah effect, and modulating the amplitude produces a tremolo effect.

Lower

A keyboard part played on the left side of the keyboard from the split point for the voices instead of LEFT. This part is not affected by the on/off status of the [ACMP] button.

N

Note On/Off

MIDI messages which represent notes played on a keyboard or other instrument. Pressing a key produces a Note On message, and a Note Off message is produced when the key is released.

Note On message includes a specific note number which corresponds to the key which is pressed, plus a velocity value based on how hard the key is struck.

P**Path**

Refers to the location of the folders and files currently indicated on the LCD display.

Pop-up window

A “small” window that appears on the LCD display temporarily.

Program Change

A MIDI channel message that determines the voice number by specifying the program number. Combining this with Bank Select messages allows you to select any of the voices via MIDI.

Preset

Preset Data supplied with the internal memory of the Tyros2 shipped from the factory. There are various types of Preset data, such as Preset voices, Preset songs, Preset waves—as opposed to User data, which is your own originally created data.

R**RAM**

An acronym for Random Access Memory that allows both reading and writing of data. This can be used for the Edit Buffer and the data created by editing or recording.

Reverb

Also called “reverberation,” this refers to the sound energy remaining in a room or closed space after the original sound stops. Similar to yet different from echo, reverb is the indirect, diffuse sound of reflections from the walls and ceiling that accompany the direct sound. The characteristics of this indirect sound depends on the size of the room or space and the materials and furnishings in the room. Reverb Effect types use digital signal processing to simulate these characteristics.

Right-hand section of the keyboard

The section of keys to the right of the split point, used to play the RIGHT 1–3 voices.

Revoice

A function that changes the voice for each part or channel of the selected style or song to one of the specially created voices of the Tyros2.

ROM

An acronym for “Read Only Memory.” This type of memory can be read from but not written to or erased. All preset data supplied with the instrument is contained on ROM.

S**Song Position**

Refers to the place within song data at which playback is started, being done, or where notes are input in step recording. This is indicated in units of Measure (Bar), Beat, Clock.

U**Upper**

A keyboard part played on the right side of the keyboard from the split point for the voices instead of RIGHT 1, 2, and 3.

User

Refers to the data you create via various functions of the Tyros2. There are various types of User data, such as User voices, User songs, User waves—as opposed to Preset data, which is factory-programmed data built into the Tyros2.

V**Velocity**

A parameter within the MIDI Note On message that conveys the force of the note.

Vibrato

A quavering, vibrating sound that is produced by regularly modulating the pitch of the voice.

Specifications

Sound Source		AWM Dynamic Stereo Sampling	
Keyboard		61 keys (C1 – C6) Initial touch/Aftertouch	
LCD Display		640 x 480 dots VGA Color LCD	
	Music Score, Lyrics	Yes	
	Text	Yes	
	RAM Capacity per a text	approx. 60 KB	
	Wallpaper Customize	Yes	
Voice	Polyphony (max)	128	
	Voice Selection	504 voices (486 Normal + 18 Mega) + 10 Organ Flute + 480 XG voices + 256 GM2 Voices + 22 Drum kits + 6 SFX Kits (And GS Voices for GS Song playback)	
	MegaVoices	(18 voices) Small Strings, Large Strings, Brass, Tenor Sax, Trumpet, Nylon Guitar, Solid Guitar 1/2, Steel Guitar, Hi String Guitar, 12Strings Guitar, Clean Guitar, Overdrive, Distortion, Acoustic Bass, Finger Bass, Pick Bass, Fretless Bass	
	Sweet! Voices	(23 voices) Jazz/Pop/Ballad TenorSax, Growl Sax, Tenor Sax, Alto Sax, Soprano Sax, Jazz/Silver/Golden Trumpet, Cornet, Trumpet, Mute Trumpet, Flugel Horn, Trombone, Violin, Harmonica, Mandolin, Oboe, Clarinet, Flute, Pan Flute, Classical Flute	
	Live! Voices	(58 voices) Dynamic Strings, Spiccato, Dynamic Brass, Power Brass, French Horn, Sax Section, Dynamic Steel Guitar, Grand Piano, Dynamic Nylon Guitar, Gospel Choir, etc.	
	Live! Drums	(9 drum kits) Live! PowerKit 1/2, Live! Studio, Live! Standard 1/2, Live! Brush, Live! Symphony, Live! PopLatin, Live! Cuban	
	Cool! Voices	(39 voices) Sparkle Stack, Curved Bars, Slide Solid, Clean Guitar, Jazz Guitar, Power Lead, etc.	
	Organ Flutes!	10 presets	
Super Articulation Voices		(42 voices) Concert Strings, Tremolo Bowing 1/2, Big Band Brass, Brass Fall f/mf, Trumpet, Trumpet Shake1/2, Saxophone, Concert Guitar, Flamenco Guitar, Steel Guitar, Warm Solid, Guitar Hero, Feedbacker, Magic Bell, etc.	
Orchestration	Upper	Right 1 – 3	
	Lower	Left	
	Split	Left (default point: F#2) Style (default point: F#2) Right 3 (default point: G2)	
Voice Expandability	Function	Voice setting Editor / Voice Creator with Wave Assign	
	Pre- Installed Memory size	4 MB	
	Additional Memory	Maximum size	1024 MB (Optional)
		Slot	168 pin DIMM x 2
Hard Disk Recorder	Control	PLAY, PAUSE, STOP, REC, PREV, NEXT	
	Playlist	Repeat, Sort, Shuffle, Marking	
	File format	Wave (16-bit, 44.1 kHz, stereo)	
Effects	Effect Blocks	Reverb/Chorus/DSP	6
		Microphone	1
	Effect Types	Reverb/Chorus/DSP	Reverb: 34 presets + 3 users Chorus: 30 presets + 3 users DSP Effect For Style: 189 presets + 3 users DSP Effect For R1/R2/R3/Left: 189 presets + 10 users DSP Effect For Mic: 189 presets + 10 users
		Mic Effects	Noise Gate x 1, Compressor x 1, 3Band EQ x 1
		Master EQ (5 band)	5 presets + 2 users
		Master Compressor	5 presets + 5 users
		Part EQ (2 band)	29 Parts (R1, R2, R3, Left, MultiPad, Style x 8, Song x 16)
		Poly/Mono	ON/OFF
	Vocal Harmony	60 presets + 10 users	
	Harmony/Echo	17 presets	
	Upper Octave	-1, 0, +1	
	Part Octave	-2, -1, 0, +1, +2	
	Pitch Bend Wheel	Available	
	Modulation Wheel	Available	

Accompaniment Style	Accompaniment Styles	400 (11 categories)	
		Pro Styles	357
		Session Styles	43
	MegaVoice Styles	(Using by preset styles)	
	Fingering	Single Finger, Fingered, Fingered On Bass, Multi Finger, AI Fingered, Full Keyboard, AI Full Keyboard	
	Control	Intro x 3, Fill In x 4, Main x 4, Break x 1, Ending x 3, Fade In/Out, Tap Tempo	
	Style Creator	YES	
	OTS (One Touch Setting)	4 for Each Style (Programmable)	
	OTS Link	YES	
	Music Finder	Preset	1,835 records
	Edit	Programmable. Up to 2,500 records.	
	RAM Capacity per a style	approx. 120 KB	
Song	Preset Songs	5	
	Control	PLAY, PAUSE, STOP, REC, FF, REW	
	Song Position Jump	4 point / Loop	
	Tracks	16	
	Guide	Follow Lights, Any Key, Karao-Key, Vocal CueTIME	
	Performance assistant Technology	YES	
	Recording	Quick Recording, Multi Recording, Step Recording, Song Editing	
	Record Channels	16	
	RAM Capacity per a song	approx. 300 KB	
Multi Pad	Preset	120	
	Control	Pad 1 – 4, Stop, Select	
Tempo		5 – 500, Tap Tempo	
Transpose		-12 – 0 – 12 (Assignable Keyboard/Song/Master)	
Tuning		414.8 – 440 – 466.8 Hz	
Internet Direct Connection		External Adapter (via USB to DEVICE)	
Memory Device	Internal Flash Memory for user drive	3.2 MB	
	Hard Disk Drive (Internal)	2.5-inch IDE (Optional)	
	Storage devices (via USB to DEVICE)	USB Flash Memory, USB Hard Disk Drive, etc.	
Registration Memory	Buttons	8	
	Control	Bank +/-, Regist Sequence, Freeze	
Others	Demo	YES	
	Language for Display	5 Languages (English, German, French, Spanish, Italian)	
	Direct Access	YES	
	Scale Type	9 presets	
	Metronome	YES	
Terminals	USB to HOST	YES	
	USB to DEVICE	YES (2 terminals: Front / Back)	
	MIDI	MIDI A (IN/OUT), MIDI B (IN/OUT)	
	Control	Foot Pedal 1 (Sustain) / 2 (S. Articulation) / 3 (Volume) Function Assignable	
	Video Out	NTSC / PAL Composite	
	RGB Out	YES	
	Audio	PHONES	
		Main Line Output (L/L+R, R)	
		Sub Output 1, Sub Output 2	
		Loop Send (L/L+R, R) / AUX Out (Level Fixed): Selectable	
		Loop Return (L/L+R, R) / Aux In	
		MIC / LINE IN (Stereo)	
For Option Speaker	To Satellite Speaker (L/R), To Sub Woofer (L/R)		
Power Supply	AC (Inlet)		
Dimensions [W x D x H] (with the Music Rest)		1,140 x 450 x 137 mm (1,140 x 536 x 371 mm)	
Weight (with the Music Rest)		14.5 kg (15.5 kg)	
Optional Accessories	Speaker	TRS-MS02	
	Headphones	HPE-150/HPE-160/HPE-170	
	Foot Switch	FC4/FC5	
	Foot Controller	FC7	
	MIDI Foot Controller	MFC-10	
	Floppy Disk Drive	UD-FD01	
	Keyboard Stand	L-7/L-7S	

* Specifications and descriptions in this owner's manual are for information purposes only. Yamaha Corp. reserves the right to change or modify products or specifications at any time without prior notice. Since specifications, equipment or options may not be the same in every locale, please check with your Yamaha dealer.

Handling the floppy disk drive (FDD) and floppy disks

An optional floppy disk drive UD-FD01 can be connected to this instrument. It lets you save original data you've created on the instrument to floppy disk, and allows you to load data from floppy disk to the instrument.

Be sure to handle floppy disks and treat the disk drive with care. Follow the important precautions below.

* The optional floppy disk drive UD-FD01 contains a drive case which is used in installation. However, on the Tyros2, the drive is to be installed directly without use of the case.

■ Floppy disk compatibility

- 3.5" 2DD and 2HD type floppy disks can be used.

■ Formatting a floppy disk

- If you find that you are unable to use new, blank disks or old disks that have been used with other devices, you may need to format them. For details on how to format a disk, see page 194. Keep in mind that all data on the disk will be lost after formatting. Make sure to check beforehand whether or not the disk contains important data.

NOTE:

- *Floppy disks formatted on this device may or may not be useable as is on other devices.*

■ Inserting/removing Floppy Disks

● Inserting a floppy disk into the disk drive

- Hold the disk so that the label of the disk is facing upward and the sliding shutter is facing forward, towards the disk slot. Carefully insert the disk into the slot, slowly pushing it all the way in until it clicks into place and the eject button pops out.

NOTE:

- *Never insert anything but floppy disks into the disk drive. Other objects may cause damage to the disk drive or floppy disks.*

● Removing a floppy disk

- After checking that the instrument is not accessing* the floppy disk (checking that the use lamp on the floppy disk drive is off), firmly press the eject button at the upper right of the disk slot all the way in. When the floppy disk is ejected, pull it out of the drive. If the floppy disk cannot be removed because it is stuck, do not try to force it, but instead try pressing the eject button again, or try re-inserting the disk and attempt to eject it again.

* *Access of the disk indicates an active operation, such as recording, playback, or deletion of data. If a floppy disk is inserted while the power is on, the disk is automatically accessed, since the instrument checks whether the disk has data.*

⚠ CAUTION

- **Do not remove the floppy disk or turn off the instrument itself while the disk is being accessed. Doing so may result not only in loss of data on the disk but also damage to the floppy disk drive.**

- Be sure to remove the floppy disk from the disk drive before turning off the power. A floppy disk left in the drive for extended periods can easily pick up dust and dirt that can cause data-read and -write errors.

■ Cleaning the disk drive read/write head

- Clean the read/write head regularly. This instrument employs a precision magnetic read/write head which, after an extended period of use, will pick up a layer of magnetic particles from the disks used that will eventually cause read and write errors.
- To maintain the disk drive in optimum working order Yamaha recommends that you use a commercially-available dry-type head cleaning disk to clean the head about once a month. Ask your Yamaha dealer about the availability of proper head-cleaning disks.

■ About floppy disks

● Handle floppy disks with care, and follow these precautions:

- Do not place heavy objects on a disk or bend or apply pressure to the disk in any way. Always keep floppy disks in their protective cases when they are not in use.
- Do not expose the disk to direct sunlight, extremely high or low temperatures, or excessive humidity, dust or liquids.
- Do not open the sliding shutter and touch the exposed surface of the floppy disk inside.
- Do not expose the disk to magnetic fields, such as those produced by televisions, speakers, motors, etc., since magnetic fields can partially or completely erase data on the disk, rendering it unreadable.
- Never use a floppy disk with a deformed shutter or housing.
- Do not attach anything other than the provided labels to a floppy disk. Also make sure that labels are attached in the proper location.

● To protect your data (write-protect tab):

- To prevent accidental erasure of important data, slide the disk's write-protect tab to the "protect" position (tab open). When saving data, make sure that the disk's write-protect tab is set to the "overwrite" position (tab closed).

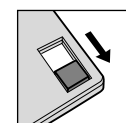
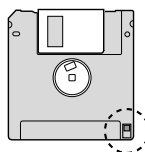

Write-protect tab
ON (locked or
write protected)

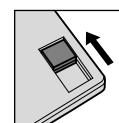

Write-protect tab
OFF (unlocked or
write enabled)

● Data backup

- For maximum data security Yamaha recommends that you keep two copies of important data on separate floppy disks. This gives you a backup if one disk is lost or damaged.

Index

Numbers

3BAND EQ 177

A

AC INLET 17

Accent Type..... 164

Accompaniment 31

ACMP 31, 81

After Touch 210

Aftertouch 87, 191

AI Fingered 153

AI Full Keyboard..... 153

Amplitude 92

Any Key 49

APPEND 172

ARABIC..... 188

ASSEMBLY..... 83, 159, 163

ASSIGN 192

ASSIGNABLE FOOT PEDAL..... 16

AT 216

Attack 93

AUTO FILL IN 34, 81

AUX IN 17

AUX OUT..... 17

B

Backup 196

BALANCE..... 36, 46, 82

Bank 53

Bar Clear 165

Bar Copy 165

BASIC..... 83, 161

Basic Operations 68

BASS 82

BASS HOLD 190

Beat 125, 127

Beat Converter 164

Bookmarks 202

BREAK 34, 81

Brightness 92, 180

C

CC..... 216

CD-ROM 6

CHANNEL 83, 123

Channel Message..... 210

CHANNEL ON/OFF..... 37, 46, 82

Channel Transpose..... 124

CHORD..... 83, 125, 152, 166

CHORD DETECT 82

CHORD FINGERING..... 82, 153

Chord Match..... 38, 170

CHORD NOTE ONLY 192

Chord Tutor 152

Chordal 178

Chorus..... 181

Clock 125, 127, 215

CMP 82, 185

Compressor 178

Computer 66

CONFIG..... 82, 193

Control Change 132, 210

CONTROLLER 82

Controls..... 14, 15

Cool! voices 86

Copy 74

Current 119

Cursor 79

Custom Voice..... 85, 94, 196

Custom Voice Bank Edit 83

Custom Voice Edit via PC 83

Custom! voices 86

CustomWA! voices 86

Cut 74

Cutoff Frequency 92

D

DATA ENTRY 68

Decay 93

Delay 93

Delete..... 75, 123

DEMO 24, 81

Depth 93

Destination..... 124

DIGITAL RECORDING
..... 83, 121, 159, 161, 169

DIMM Installation 223

Direct Access..... 70

Disk..... 231

DORIAN 166

Downloading Data 201

Drum Kit 85

Drums 86

DSP 39, 83, 87

DSP Type..... 90

DSP VARIATION..... 39, 87, 190

DSP1-6..... 181

Dynamics..... 163

E

Echo Types..... 192

EDIT..... 83, 170

EFFECT 81, 82, 175, 181

EG..... 93

ENDING 34, 81, 190

ENTER 68

Entering Characters..... 76

Entering Characters
(Internet Direct Connection) 199

Envelope Generator..... 93

EQ..... 82, 184

EQUAL TEMPERAMENT 188

Equalizer 184

ESEQ..... 212

Event List 121, 125, 127, 162, 170

Exclusive Messages 210

EXIT..... 69

F

Factory Reset..... 196

FADE IN TIME 193

FADE IN/OUT.. 35, 81, 154, 190, 193

FADE OUT HOLD TIME 193

FADE OUT TIME 193

FF (Fast Forward)..... 43, 81, 117

File 71

FILE ACCESS 81, 156

FILL BREAK 190

FILL DOWN 190

FILL IN..... 34

FILL SELF 190

FILL UP 190

- FILTER 82, 92, 180
 Fine 164
 FINGERD/FING ON BASS 190
 Fingered 153
 Fingered On Bass 153
 Fingering 152
 Floppy Disk Drive 231
 Folder 71
 Follow Lights 49, 50
 FOOT PEDAL 82, 189
 Foot Volume 189
 Footage 89
 Footswitch 189
 Format 194
 FREEZE 54, 82, 173
 Full Keyboard 153
 FUNCTION 82, 187
 Function Tree 81
- G**
 GLIDE 189
 GM 85
 GM2 85
 GROOVE 83, 163
 GS 212
 GUIDE 49, 81
- H**
 HARD DISK
 RECORDER 59, 83, 135
 Harmonic Content 92, 180
 HARMONIC MINOR 166
 Harmony Mode 48
 Harmony Types 192
 HARMONY/ECHO .. 39, 83, 190, 191
 HD drive 29, 71
 HDR PLAY/PAUSE 190
 HIGH KEY 160, 167
- I**
 IDC (Internet Direct Connection) ... 197
 INDIVIDUAL LOAD 83, 104
 INITIAL TOUCH 39, 83, 87
 Initializing Internet Settings 208
 INPUT VOLUME 47, 81, 175
 Insertion Effect 182
- Installing a Hard Disk 221
 Internet Connection 197
 Internet Glossary 209
 Internet Settings 205
 INTRO 34, 81
- J**
 Jump 44
 Jump Marker 117
- K**
 Karao-key 49
 Kbd. Vel (Keyboard Velocity) 128
 Key Signature 113, 133
 Keyboard 14, 80, 87
 Keyboard Part 84, 179
 Keyboard Transpose 88
 Keyword 41
- L**
 Language 23, 119, 195
 LCD 68, 188
 LCD buttons 68
 LCD contrast 21
 LEFT 27, 80, 190
 Left Hold 84
 Length 90
 LFO 92
 LIBRARY LOAD 83, 106
 LIBRARY SAVE 83, 108
 LINE IN 17
 LINE OUT 17, 82, 185
 Live! voices 86
 Live!Drums voices 86
 Live!SFX voices 86
 Local Control 215
 LOOP 43, 44, 81
 Loop End Marker 117
 Loop Recording 160
 LOOP RETURN 17
 LOOP SEND 17
 Lower 215
 LYRICS 83, 114, 188
 Lyrics Background Picture 71
 LYRICS PAGE +/- 190
 LYRICS/TEXT 81, 114, 115
- M**
 MAIN 190
 MAIN (LINE OUT) 17
 Main display 22
 MAIN jacks 186
 Main Picture 71, 195
 MAIN VARIATION 34, 81
 Marker 44, 133
 Master Compressor 181, 185
 Master EQ 181, 184
 Master Transpose 88
 MASTER TUNE 82, 187
 MASTER VOLUME 20, 81
 Maximum Polyphony 86
 MEAN-TONE 188
 Measure 125, 127
 MEDIA 82, 194
 MegaVoice 86
 MELODIC MINOR 166
 MEMORY 52, 82
 Memory Drive 70
 Message 69
 Message Switch 215
 Meta Event 133
 Metronome 81, 193
 MFC10 16, 82, 217
 MIC 17, 175
 MIC SETTING 81
 MIC/LINE IN 17, 47, 81, 175
 Microphone 47, 175
 MIDI 82, 210
 MIDI A IN/OUT 16
 MIDI B IN/OUT 16
 MIDI Channel 211
 MIDI Setup 71, 196
 MIDI Template 71, 214
 Mix 124
 MIXING CONSOLE 82, 179
 Mode 90
 MODULATION
 wheel 83, 88, 92, 190, 191
 Monitor 116
 MONO 39, 83, 87, 91
 Multi Assign 192
 Multi Finger 153

- Multi Pad 38, 71, 169
Multi Pad Bank 71
MULTI PAD CONTROL .. 38, 82, 169
Multi Recording 57
Music Finder 40, 71, 171, 196
Music Rest 14, 19
- N**
Name 76
NATURAL MINOR 166
New Song 55, 57
Next/Cancel 118
Noise Gate 178
Normalize 143
Note 132
Note Limit 160, 167
Note Name 84, 113
Note Number 210
Note Off 210
Note On 210
Note Transposition 160
NTR 160, 166
NTSC 16
NTT 160, 166
- O**
Octave 27, 91, 180
ONE TOUCH SETTING 36, 155
Open/Save display 29, 72, 77
Organ Flutes 28, 85, 89
Organ Flutes! voices 86
Organ Type 89
OTS 155, 190
OTS LINK 81, 155
OTS Link Timing 157
OVER 47, 175
Overdub Recording 160
OWNER 82, 195
Owner Name 195
- P**
P.A.T. 81, 120
PAL 16
Panpot 180
PARAMETER 83, 165
Parameter Lock 193
Part 179
Part EQ 181
PART ON/OFF 25, 80, 83, 84
Part On/Off 158
PART SELECT 25, 83, 84
Part Settings 180
Paste 74
Path 78
PB 216
PC 216
PEDAL PUNCH IN/OUT 122
PERCUSSION 190
performance assistant Technology .. 120
Phrase Mark 117, 119
PITCH BEND 189
Pitch Bend 210
Pitch Bend Range 180
PITCH BEND wheel 83, 88
PLAY/PAUSE 83
Playlist 147
Poly 87, 91
Poly/Mono 87
Polyphony 86
PORTAMENTO 189
Portamento 87
Portamento Time 91, 180
POWER ON/OFF 20, 22, 81
Preset drive 29, 71
Program Change 132, 210
Property 65, 77, 136
PUNCH IN AT 122
Punch In/Out 121
PUNCH OUT AT 122
PURE MAJOR 188
PURE MINOR 188
PYTHAGORIAN 188
- Q**
Quantize 123
Quick Recording 55
Quick Start 119
- R**
Random 119
Realtime Message 210
Realtime Recording 121
REC 55, 81, 83
REC END 122
REC MODE 83, 122
REC START 122
RECEIVE 82
Receive Transpose 215
RECORD 83, 169
Record (Music Finder) 40, 171
Recording 55
REGIST BANK 53, 82
REGISTRATION
MEMORY 52, 82, 173
Registration Memory Bank 71
REGISTRATION MEMORY
CONTENTS 52, 82
Registration Sequence 54, 173
Release 93
Repeat 119, 170
Repeat Folder 119
Repertoire 33
REPLACE 172
REPLACE ALL 122
Resonance 92
Response 90
Reverb 181
REW (Rewind) 43, 81, 117
RGB OUT 16
RIGHT 1 25, 80, 190
RIGHT 2 26, 80, 190
RIGHT 3 80, 190
rit. 34
ROOT FIXED 166
ROOT TRANS 166
Rotary Speaker Speed 89
RTR 160, 167
- S**
S. ARTICULATION 16, 190
S. Articulation! voices 86
Save 75
SCALE TUNE 82, 187
SCORE 81, 112
SCORE PAGE +/- 190
SCREEN OUT 82, 188
Search 41

- Section 34
- Section Set 158
- SELECT 38, 82, 83
- Sequence Format 212
- SETTING 83
- Setup 124
- SFX 86
- SIGNAL 47, 175
- Single Finger 153
- Sleep Time 194
- SMF 212
- SOFT 189
- SONG 43, 71, 78, 81, 112
- Song Auto Open 194
- Song Auto Revoice 181
- SONG CONTROL 43
- SONG CREATOR 83, 121
- Song Position 117
- Song Position Marker 117, 133
- SONG SETTING 82, 118
- Song Transpose 88
- SOSTENUTO 189
- Source 124
- Source Chord 160, 166
- Source Pattern 160
- Source Root 160, 166
- SP (Song Position) 43, 81
- Speaker 18, 193, 219
- SPEED 192
- Split Point 31, 80, 158
- START/STOP 81, 215
- Step Recording 121
- STOP 81, 82, 83
- Stop Accompaniment 33, 157
- STRENGTH 123
- STYLE 31, 71, 81, 152, 156
- STYLE CONTROL 34, 81
- STYLE CREATOR 83, 159
- Style Touch 157
- SUB 17
- SUB jacks 186
- Super Articulation 86
- SUSTAIN 16, 39, 83, 87, 189
- Sweet! voices 86
- Swing 164
- SYNC START 31, 80, 81, 155, 190
- SYNC STOP 35, 81, 155, 190
- Synchro Stop Window 157
- SYS/EX 83, 215
- SYSTEM 82, 215
- System Effect 182
- System Exclusive Message 210
- System Message 210
- SYSTEM RESET 82, 196
- System Setup 71, 196
- T**
- TAB 69
- TALK 81, 190
- Talk Setting 177
- Tap 35, 154
- TAP TEMPO 81, 154, 190
- TEMPO 81, 133, 154, 158
- Terminals 16, 17
- Text 115
- TEXT PAGE +/- 190
- Time Signature 133
- TO DEVICE 16
- TO HOST 16
- TO LEFT SPEAKER 17
- TO RIGHT SPEAKER 16
- TO SUB WOOFER 17
- TOUCH LIMIT 192
- Touch Sense 91
- TRANSMIT 82, 215
- TRANSMIT CLOCK 215
- TRANSPOSE 81, 88, 180
- TRANSPOSE ASSIGN 191
- TRIM 17
- TUNE 82
- Tuning 180, 187
- U**
- Upper 215
- UPPER OCTAVE 27, 83, 88
- USB 16
- USB drive 29, 71
- USB Storage Device 64
- USB TO DEVICE 15, 16, 64
- USB TO HOST 16, 66
- User drive 29, 71
- User Effect 71, 183, 196
- User Master Compressor 71, 185
- User Master EQ 71, 184
- UTILITY 82, 193
- V**
- Velocity 210
- Version Number 195
- VH TYPE SELECT 48, 81, 175
- Vibrato 93
- Vibrato Depth 89
- Vibrato On/Off 89
- Vibrato Speed 90
- VIDEO OUT 16, 188
- VIEW 77
- Vocal Cue Time 49, 51
- VOCAL
- HARMONY 48, 81, 181, 190
- Vocal Harmony Mode 178
- Vocal Harmony Type 48
- Vocoder 178
- VOICE 25, 71, 83, 84, 85
- Voice Allocation Format 212
- VOICE CREATOR 83, 95
- Voice Editor 111
- VOICE EFFECT 39, 83, 87
- Voice Information 25
- Voice Number 193
- VOICE SET 82, 89, 91, 188
- VOL/VOICE 82, 180
- VOLUME 16, 90, 91, 189, 192
- W**
- WAVE IMPORT 83, 94
- X**
- XG 85

Limited Warranty

90 DAYS LABOR

1 YEAR PARTS

Yamaha Corporation of America, hereafter referred to as Yamaha, warrants to the original consumer of a product included in the categories listed below, that the product will be free of defects in materials and/or workmanship for the periods indicated. This warranty is applicable to all models included in the following series of products:

DIGITAL WORKSTATION

If during the first 90 days that immediately follows the purchase date, your new Yamaha product covered by this warranty is found to have a defect in material and/or workmanship, Yamaha and/or its authorized representative will repair such defect without charge for parts or labor.

If parts should be required after this 90 day period but within the one year period that immediately follows the purchase date, Yamaha will, subject to the terms of this warranty, supply these parts without charge. However, charges for labor, and/or any miscellaneous expenses incurred are the consumers responsibility. Yamaha reserves the right to utilize reconditioned parts in repairing these products and/or to use reconditioned units as warranty replacements.

THIS WARRANTY IS THE ONLY EXPRESS WARRANTY WHICH YAMAHA MAKES IN CONNECTION WITH THESE PRODUCTS. ANY IMPLIED WARRANTY APPLICABLE TO THE PRODUCT, INCLUDING THE WARRANTY OF MERCHANTABILITY IS LIMITED TO THE DURATION OF THE EXPRESS WARRANTY. YAMAHA EXCLUDES AND SHALL NOT BE LIABLE IN ANY EVENT FOR INCIDENTAL OR CONSEQUENTIAL DAMAGES.

Some states do not allow limitations that relate to implied warranties and/or the exclusion of incidental or consequential damages. Therefore, these limitations and exclusions may not apply to you.

This warranty gives you specific legal rights. You may also have other rights which vary from state to state.

CONSUMERS RESPONSIBILITIES

If warranty service should be required, it is necessary that the consumer assume certain responsibilities:

1. Contact the Customer Service Department of the retailer selling the product, or any retail outlet authorized by Yamaha to sell the product for assistance. You may also contact Yamaha directly at the address provided below.
2. Deliver the unit to be serviced under warranty to: the retailer selling the product, an authorized service center, or to Yamaha with an explanation of the problem. Please be prepared to provide proof purchase date (sales receipt, credit card copy, etc.) when requesting service and/or parts under warranty.
3. Shipping and/or insurance costs are the consumers responsibility.* Units shipped for service should be packed securely.

*Repaired units will be returned PREPAID if warranty service is required within the first 90 days.

IMPORTANT: Do NOT ship anything to ANY location without prior authorization. A Return Authorization (RA) will be issued that has a tracking number assigned that will expedite the servicing of your unit and provide a tracking system if needed.

4. Your owners manual contains important safety and operating instructions. It is your responsibility to be aware of the contents of this manual and to follow all safety precautions.

EXCLUSIONS

This warranty does not apply to units whose trade name, trademark, and/or ID numbers have been altered, defaced, exchanged removed, or to failures and/or damages that may occur as a result of:

1. Neglect, abuse, abnormal strain, modification or exposure to extremes in temperature or humidity.
2. Improper repair or maintenance by any person who is not a service representative of a retail outlet authorized by Yamaha to sell the product, an authorized service center, or an authorized service representative of Yamaha.
3. This warranty is applicable only to units sold by retailers authorized by Yamaha to sell these products in the U.S.A., the District of Columbia, and Puerto Rico. This warranty is not applicable in other possessions or territories of the U.S.A. or in any other country.

Please record the model and serial number of the product you have purchased in the spaces provided below.

Model _____ Serial # _____ Sales Slip # _____

Purchased from _____ Date _____
(Retailer)

YAMAHA CORPORATION OF AMERICA
Electronic Service Division
6600 Orangethorpe Avenue
Buena Park, CA 90620

KEEP THIS DOCUMENT FOR YOUR RECORDS. DO NOT MAIL!

FCC INFORMATION (U.S.A.)

1. IMPORTANT NOTICE: DO NOT MODIFY THIS UNIT!

This product, when installed as indicated in the instructions contained in this manual, meets FCC requirements. Modifications not expressly approved by Yamaha may void your authority, granted by the FCC, to use the product.

2. IMPORTANT: When connecting this product to accessories and/or another product use only high quality shielded cables. Cable/s supplied with this product MUST be used. Follow all installation instructions. Failure to follow instructions could void your FCC authorization to use this product in the USA.

3. NOTE: This product has been tested and found to comply with the requirements listed in FCC Regulations, Part 15 for Class "B" digital devices. Compliance with these requirements provides a reasonable level of assurance that your use of this product in a residential environment will not result in harmful interference with other electronic devices. This equipment generates/uses radio frequencies and, if not installed and used according to the instructions found in the users manual, may cause interference harmful to the operation of other electronic devices. Compliance with FCC regulations does

not guarantee that interference will not occur in all installations. If this product is found to be the source of interference, which can be determined by turning the unit "OFF" and "ON", please try to eliminate the problem by using one of the following measures:

Relocate either this product or the device that is being affected by the interference.

Utilize power outlets that are on different branch (circuit breaker or fuse) circuits or install AC line filter/s.

In the case of radio or TV interference, relocate/reorient the antenna. If the antenna lead-in is 300 ohm ribbon lead, change the lead-in to co-axial type cable.

If these corrective measures do not produce satisfactory results, please contact the local retailer authorized to distribute this type of product. If you can not locate the appropriate retailer, please contact Yamaha Corporation of America, Electronic Service Division, 6600 Orangethorpe Ave, Buena Park, CA90620

The above statements apply ONLY to those products distributed by Yamaha Corporation of America or its subsidiaries.

* This applies only to products distributed by YAMAHA CORPORATION OF AMERICA.

(class B)

IMPORTANT NOTICE FOR THE UNITED KINGDOM Connecting the Plug and Cord

IMPORTANT. The wires in this mains lead are coloured in accordance with the following code:

BLUE : NEUTRAL
BROWN : LIVE

As the colours of the wires in the mains lead of this apparatus may not correspond with the coloured markings identifying the terminals in your plug proceed as follows:

The wire which is coloured BLUE must be connected to the terminal which is marked with the letter N or coloured BLACK.

The wire which is coloured BROWN must be connected to the terminal which is marked with the letter L or coloured RED.

Making sure that neither core is connected to the earth terminal of the three pin plug.

* This applies only to products distributed by Yamaha-Kemble Music (U.K.) Ltd. (2 wires)

This product contains a high intensity lamp that contains a small amount of mercury. Disposal of this material may be regulated due to environmental considerations.

For disposal information in the United States, refer to the Electronic Industries Alliance web site:

www.eiae.org

* This applies only to products distributed by YAMAHA CORPORATION OF AMERICA.

(mercury)

CAUTION: TO PREVENT ELECTRIC SHOCK, MATCH WIDE BLADE OF PLUG TO WIDE SLOT, FULLY INSERT.

ATTENTION: POUR ÉVITER LES CHOCS ÉLECTRIQUES, INTRODUIRE LA LAME LA PLUS LARGE DE LA FICHE DANS LA BORNE CORRESPONDANTE DE LA PRISE ET POUSSER JUSQU'AU FOND.

* This applies only to products distributed by Yamaha Canada Music Ltd. (polarity)
* Ceci ne s'applique qu'aux produits distribués par Yamaha Canada Musique Ltée.

COMPLIANCE INFORMATION STATEMENT (DECLARATION OF CONFORMITY PROCEDURE)

Responsible Party : Yamaha Corporation of America
Address : 6600 Orangethorpe Ave., Buena Park,
Calif. 90620

Telephone : 714-522-9011

Type of Equipment : DIGITAL WORKSTATION

Model Name : Tyros2

This device complies with Part 15 of the FCC Rules.

Operation is subject to the following conditions:

- 1) this device may not cause harmful interference, and
- 2) this device must accept any interference received including interference that may cause undesired operation.

See user manual instructions if interference to radio reception is suspected.

* This applies only to products distributed by YAMAHA CORPORATION OF AMERICA.

(FCC DoC)

For details of products, please contact your nearest Yamaha representative or the authorized distributor listed below.

Pour plus de détails sur les produits, veuillez-vous adresser à Yamaha ou au distributeur le plus proche de vous figurant dans la liste suivante.

Die Einzelheiten zu Produkten sind bei Ihrer unten aufgeführten Niederlassung und bei Yamaha Vertragshändlern in den jeweiligen Bestimmungsländern erhältlich.

Para detalles sobre productos, contacte su tienda Yamaha más cercana o el distribuidor autorizado que se lista debajo.

NORTH AMERICA

CANADA

Yamaha Canada Music Ltd.
135 Milner Avenue, Scarborough, Ontario,
M1S 3R1, Canada
Tel: 416-298-1311

U.S.A.

Yamaha Corporation of America
6600 Orangethorpe Ave., Buena Park, Calif. 90620,
U.S.A.
Tel: 714-522-9011

CENTRAL & SOUTH AMERICA

MEXICO

Yamaha de México S.A. de C.V.
Calz. Javier Rojo Gómez #1149,
Col. Guadalupe del Moral
C.P. 09300, México, D.F., México
Tel: 55-5804-0600

BRAZIL

Yamaha Musical do Brasil Ltda.
Av. Reboucas 2636-Pinheiros CEP: 05402-400
Sao Paulo-SP. Brasil
Tel: 011-3085-1377

ARGENTINA

Yamaha Music Latin America, S.A.
Sucursal de Argentina
Viamonte 1145 Piso2-B 1053,
Buenos Aires, Argentina
Tel: 1-4371-7021

PANAMA AND OTHER LATIN AMERICAN COUNTRIES/ CARIBBEAN COUNTRIES

Yamaha Music Latin America, S.A.
Torre Banco General, Piso 7, Urbanización Marbella,
Calle 47 y Aquilino de la Guardia,
Ciudad de Panamá, Panamá
Tel: +507-269-5311

EUROPE

THE UNITED KINGDOM

Yamaha-Kemble Music (U.K.) Ltd.
Sherbourne Drive, Tilbrook, Milton Keynes,
MK7 8BL, England
Tel: 01908-366700

IRELAND

Danfay Ltd.
61D, Sallynoggin Road, Dun Laoghaire, Co. Dublin
Tel: 01-2859177

GERMANY

Yamaha Music Central Europe GmbH
Siemensstraße 22-34, 25462 Rellingen, Germany
Tel: 04101-3030

SWITZERLAND/LIECHTENSTEIN

Yamaha Music Central Europe GmbH,
Branch Switzerland
Seefeldstrasse 94, 8008 Zürich, Switzerland
Tel: 01-383 3990

AUSTRIA

Yamaha Music Central Europe GmbH,
Branch Austria
Schleiergasse 20, A-1100 Wien, Austria
Tel: 01-60203900

CZECH REPUBLIC/SLOVAKIA/ HUNGARY/SLOVENIA

Yamaha Music Central Europe GmbH,
Branch Austria, CEE Department
Schleiergasse 20, A-1100 Wien, Austria
Tel: 01-602039025

POLAND

Yamaha Music Central Europe GmbH
Sp.z o.o. Oddział w Polsce
ul. 17 Stycznia 56, PL-02-146 Warszawa, Poland
Tel: 022-868-07-57

THE NETHERLANDS/ BELGIUM/LUXEMBOURG

Yamaha Music Central Europe GmbH,
Branch Benelux
Clarissenhof 5-b, 4133 AB Vianen, The Netherlands
Tel: 0347-358 040

FRANCE

Yamaha Musique France
BP 70-77312 Marne-la-Vallée Cedex 2, France
Tel: 01-64-61-4000

ITALY

Yamaha Musica Italia S.P.A.
Viale Italia 88, 20020 Lainate (Milano), Italy
Tel: 02-935-771

SPAIN/PORTUGAL

Yamaha-Hazen Música, S.A.
Ctra. de la Coruna km. 17, 200, 28230
Las Rozas (Madrid), Spain
Tel: 91-639-8888

GREECE

Philippos Nakas S.A. The Music House
147 Skiathou Street, 112-55 Athens, Greece
Tel: 01-228 2160

SWEDEN

Yamaha Scandinavia AB
J. A. Wettergrens Gata 1
Box 30053
S-400 43 Göteborg, Sweden
Tel: 031 89 34 00

DENMARK

YS Copenhagen Liaison Office
Generatorvej 6A
DK-2730 Herlev, Denmark
Tel: 44 92 49 00

FINLAND

F-Musiikki Oy
Kluuvikatu 6, P.O. Box 260,
SF-00101 Helsinki, Finland
Tel: 09 618511

NORWAY

Norsk filial av Yamaha Scandinavia AB
Grini Næringspark 1
N-1345 Østerås, Norway
Tel: 67 16 77 70

ICELAND

Skifan HF
Skeifan 17 P.O. Box 8120
IS-128 Reykjavik, Iceland
Tel: 525 5000

OTHER EUROPEAN COUNTRIES

Yamaha Music Central Europe GmbH
Siemensstraße 22-34, 25462 Rellingen, Germany
Tel: +49-4101-3030

AFRICA

Yamaha Corporation,
Asia-Pacific Music Marketing Group
Nakazawa-cho 10-1, Hamamatsu, Japan 430-8650
Tel: +81-53-460-2312

MIDDLE EAST

TURKEY/CYPRUS

Yamaha Music Central Europe GmbH
Siemensstraße 22-34, 25462 Rellingen, Germany
Tel: 04101-3030

OTHER COUNTRIES

Yamaha Music Gulf FZE
LB21-128 Jebel Ali Freezone
P.O.Box 17328, Dubai, U.A.E.
Tel: +971-4-881-5868

ASIA

THE PEOPLE'S REPUBLIC OF CHINA

Yamaha Music & Electronics (China) Co.,Ltd.
25/F., United Plaza, 1468 Nanjing Road (West),
Jingan, Shanghai, China
Tel: 021-6247-2211

HONG KONG

Tom Lee Music Co., Ltd.
11/F., Silvercord Tower 1, 30 Canton Road,
Tsimshatsui, Kowloon, Hong Kong
Tel: 2737-7688

INDONESIA

PT. Yamaha Music Indonesia (Distributor)
PT. Nusantik
Gedung Yamaha Music Center, Jalan Jend. Gatot
Subroto Kav. 4, Jakarta 12930, Indonesia
Tel: 21-520-2577

KOREA

Yamaha Music Korea Ltd.
Tong-Yang Securities Bldg. 16F 23-8 Yoido-dong,
Youngdungpo-ku, Seoul, Korea
Tel: 02-3770-0660

MALAYSIA

Yamaha Music Malaysia, Sdn., Bhd.
Lot 8, Jalan Perbandaran, 47301 Kelana Jaya,
Petaling Jaya, Selangor, Malaysia
Tel: 3-78030900

PHILIPPINES

Yupangco Music Corporation
339 Gil J. Puyat Avenue, P.O. Box 885 MCPO,
Makati, Metro Manila, Philippines
Tel: 819-7551

SINGAPORE

Yamaha Music Asia Pte., Ltd.
#03-11 A-Z Building
140 Paya Lebor Road, Singapore 409015
Tel: 747-4374

TAIWAN

Yamaha KHS Music Co., Ltd.
3F, #6, Sec.2, Nan Jing E. Rd. Taipei.
Taiwan 104, R.O.C.
Tel: 02-2511-8688

THAILAND

Siam Music Yamaha Co., Ltd.
891/1 Siam Motors Building, 15-16 floor
Rama 1 road, Wangmai, Pathumwan
Bangkok 10330, Thailand
Tel: 02-215-2626

OTHER ASIAN COUNTRIES

Yamaha Corporation,
Asia-Pacific Music Marketing Group
Nakazawa-cho 10-1, Hamamatsu, Japan 430-8650
Tel: +81-53-460-2317

OCEANIA

AUSTRALIA

Yamaha Music Australia Pty. Ltd.
Level 1, 99 Queensbridge Street, Southbank,
Victoria 3006, Australia
Tel: 3-9693-5111

NEW ZEALAND

Music Houses of N.Z. Ltd.
146/148 Captain Springs Road, Te Papapa,
Auckland, New Zealand
Tel: 9-634-0099

COUNTRIES AND TRUST TERRITORIES IN PACIFIC OCEAN

Yamaha Corporation,
Asia-Pacific Music Marketing Group
Nakazawa-cho 10-1, Hamamatsu, Japan 430-8650
Tel: +81-53-460-2312



Yamaha Home Keyboards Home Page (English Only)
<http://music.yamaha.com/homekeyboard>

Yamaha Manual Library
<http://www.yamaha.co.jp/manual/>

U.R.G., Pro Audio & Digital Musical Instrument Division, Yamaha Corporation
© 2005 Yamaha Corporation

WE86550 | 602POCP4.3-03C0
Printed in Japan