



# *RX-V665*

---

*AV Receiver*

OWNER'S MANUAL



# IMPORTANT SAFETY INSTRUCTIONS

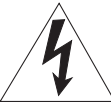

**CAUTION**  
**RISK OF ELECTRIC SHOCK**  
**DO NOT OPEN**



CAUTION: TO REDUCE THE RISK OF ELECTRIC SHOCK, DO NOT REMOVE COVER (OR BACK). NO USER-SERVICEABLE PARTS INSIDE. REFER SERVICING TO QUALIFIED SERVICE PERSONNEL.

## • Explanation of Graphical Symbols

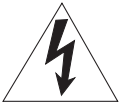

The lightning flash with arrowhead symbol, within an equilateral triangle, is intended to alert you to the presence of uninsulated "dangerous voltage" within the product's enclosure that may be of sufficient magnitude to constitute a risk of electric shock to persons.



The exclamation point within an equilateral triangle is intended to alert you to the presence of important operating and maintenance (servicing) instructions in the literature accompanying the appliance.

### Note to CATV system installer:

This reminder is provided to call the CATV system installer's attention to Article 820-40 of the NEC that provides guidelines for proper grounding and, in particular, specifies that the cable ground shall be connected to the grounding system of the building, as close to the point of cable entry as practical.

- 1 Read these instructions.
- 2 Keep these instructions.
- 3 Heed all warnings.
- 4 Follow all instructions.
- 5 Do not use this apparatus near water.
- 6 Clean only with dry cloth.
- 7 Do not block any ventilation openings. Install in accordance with the manufacturer's instructions.
- 8 Do not install near any heat sources such as radiators, heat registers, stoves, or other apparatus (including amplifiers) that produce heat.
- 9 Do not defeat the safety purpose of the polarized or grounding-type plug. A polarized plug has two blades with one wider than the other. A grounding type plug has two blades and a third grounding prong. The wide blade or the third prong are provided for your safety. If the provided plug does not fit into your outlet, consult an electrician for replacement of the obsolete outlet.
- 10 Protect the power cord from being walked on or pinched particularly at plugs, convenience receptacles, and the point where they exit from the apparatus.
- 11 Only use attachments/accessories specified by the manufacturer.
- 12 Use only with the cart, stand, tripod, bracket, or table specified by the manufacturer, or sold with the apparatus. When a cart is used, use caution when moving the cart/apparatus combination to avoid injury from tip-over.
- 13 Unplug this apparatus during lightning storms or when unused for long periods of time.
- 14 Refer all servicing to qualified service personnel. Servicing is required when the apparatus has been damaged in any way, such as power-supply cord or plug is damaged, liquid has been spilled or objects have fallen into the apparatus, the apparatus has been exposed to rain or moisture, does not operate normally, or has been dropped.



## FCC INFORMATION (for US customers)

### 1 IMPORTANT NOTICE: DO NOT MODIFY THIS UNIT!

This product, when installed as indicated in the instructions contained in this manual, meets FCC requirements. Modifications not expressly approved by Yamaha may void your authority, granted by the FCC, to use the product.

- 2 **IMPORTANT:** When connecting this product to accessories and/or another product use only high quality shielded cables. Cable/s supplied with this product **MUST** be used. Follow all installation instructions. Failure to follow instructions could void your FCC authorization to use this product in the USA.

- 3 **NOTE:** This product has been tested and found to comply with the requirements listed in FCC Regulations, Part 15 for Class "B" digital devices. Compliance with these requirements provides a reasonable level of assurance that your use of this product in a residential environment will not result in harmful interference with other electronic devices.

This equipment generates/uses radio frequencies and, if not installed and used according to the instructions found in the users manual, may cause interference harmful to the operation of other electronic devices.

Compliance with FCC regulations does not guarantee that interference will not occur in all installations. If this product is found to be the source of interference, which can be determined by turning the unit "OFF" and "ON", please try to eliminate the problem by using one of the following measures:

Relocate either this product or the device that is being affected by the interference.

Utilize power outlets that are on different branch (circuit breaker or fuse) circuits or install AC line filter/s.

In the case of radio or TV interference, relocate/reorient the antenna. If the antenna lead-in is 300 ohm ribbon lead, change the lead-in to coaxial type cable.

If these corrective measures do not produce satisfactory results, please contact the local retailer authorized to distribute this type of product. If you can not locate the appropriate retailer, please contact Yamaha Electronics Corp., U.S.A. 6660 Orangethorpe Ave, Buena Park, CA 90620.

The above statements apply **ONLY** to those products distributed by Yamaha Corporation of America or its subsidiaries.

# Caution: Read this before operating your unit.

- 1 To assure the finest performance, please read this manual carefully. Keep it in a safe place for future reference.
- 2 Install this sound system in a well ventilated, cool, dry, clean place – away from direct sunlight, heat sources, vibration, dust, moisture, and/or cold. Allow ventilation space of at least 30 cm on the top, 20 cm on the left and right, and 20 cm on the back of this unit.
- 3 Locate this unit away from other electrical appliances, motors, or transformers to avoid humming sounds.
- 4 Do not expose this unit to sudden temperature changes from cold to hot, and do not locate this unit in an environment with high humidity (i.e. a room with a humidifier) to prevent condensation inside this unit, which may cause an electrical shock, fire, damage to this unit, and/or personal injury.
- 5 Avoid installing this unit where foreign objects may fall onto this unit and/or this unit may be exposed to liquid dripping or splashing. On the top of this unit, do not place:
  - Other components, as they may cause damage and/or discoloration on the surface of this unit.
  - Burning objects (i.e. candles), as they may cause fire, damage to this unit, and/or personal injury.
  - Containers with liquid in them, as they may fall and liquid may cause electrical shock to the user and/or damage to this unit.
- 6 Do not cover this unit with a newspaper, tablecloth, curtain, etc. in order not to obstruct heat radiation. If the temperature inside this unit rises, it may cause fire, damage to this unit, and/or personal injury.
- 7 Do not plug in this unit to a wall outlet until all connections are complete.
- 8 Do not operate this unit upside-down. It may overheat, possibly causing damage.
- 9 Do not use force on switches, knobs and/or cords.
- 10 When disconnecting the power cable from the wall outlet, grasp the plug; do not pull the cable.
- 11 Do not clean this unit with chemical solvents; this might damage the finish. Use a clean, dry cloth.
- 12 Only voltage specified on this unit must be used. Using this unit with a higher voltage than specified is dangerous and may cause fire, damage to this unit, and/or personal injury. Yamaha will not be held responsible for any damage resulting from use of this unit with a voltage other than specified.
- 13 To prevent damage by lightning, keep the power cord and outdoor antennas disconnected from a wall outlet or the unit during a lightning storm.
- 14 Do not attempt to modify or fix this unit. Contact qualified Yamaha service personnel when any service is needed. The cabinet should never be opened for any reasons.
- 15 When not planning to use this unit for long periods of time (i.e. vacation), disconnect the AC power plug from the wall outlet.
- 16 Install this unit near the AC outlet and where the AC power plug can be reached easily.
- 17 Be sure to read the “Troubleshooting” section on common operating errors before concluding that this unit is faulty.
- 18 Before moving this unit, press **Ⓐ MAIN ZONE ON/OFF** to set this unit to the standby mode, and disconnect the AC power plug from the wall outlet in the main room and Zone2.
- 19 **VOLTAGE SELECTOR** (Asia and General models only)  
The **VOLTAGE SELECTOR** on the rear panel of this unit must be set for your local main voltage **BEFORE** plugging into the AC wall outlet. Voltages are:
  - .....AC 110/120/220/230–240 V, 50/60 Hz (General model)
  - ..... AC 220/230–240 V, 50/60 Hz (Asia model)
- 20 The batteries shall not be exposed to excessive heat such as sunshine, fire or like.
- 21 Excessive sound pressure from earphones and headphones can cause hearing loss.
- 22 When replacing the batteries, be sure to use batteries of the same type. Danger of explosion may happen if batteries are incorrectly replaced.

## WARNING

TO REDUCE THE RISK OF FIRE OR ELECTRIC SHOCK, DO NOT EXPOSE THIS UNIT TO RAIN OR MOISTURE.

As long as this unit is connected to the AC wall outlet, it is not disconnected from the AC power source even if you turn off this unit by **Ⓐ MAIN ZONE ON/OFF**. In this state, this unit is designed to consume a very small quantity of power.

## FOR CANADIAN CUSTOMERS

To prevent electric shock, match wide blade of plug to wide slot and fully insert.  
This Class B digital apparatus complies with Canadian ICES-003.

## POUR LES CONSOMMATEURS CANADIENS

Pour éviter les chocs électriques, introduire la lame la plus large de la fiche dans la borne correspondante de la prise et pousser jusqu'au fond.  
Cet appareil numérique de la classe B est conforme à la norme NMB-003 du Canada.

## IMPORTANT

Please record the serial number of this unit in the space below.

MODEL:

Serial No.:

The serial number is located on the rear of the unit. Retain this Owner's Manual in a safe place for future reference.

# Contents

INTRODUCTION

PREPARATION

OPERATION

ADVANCED OPERATION

APPENDIX

English

## INTRODUCTION

Features.....	2
About this manual.....	3
Supplied accessories.....	3
Part names and functions.....	4
Front panel.....	4
Rear panel.....	5
Front panel display.....	6
Remote control.....	7
Quick start guide.....	8

## PREPARATION

Preparing remote control.....	9
Installing batteries in the remote control.....	9
Using the remote control.....	9
Connections.....	10
Placing speakers.....	10
Connecting speakers.....	11
Information on jacks and cable plugs.....	13
Connecting a TV monitor or projector.....	14
Connecting other components.....	15
Connecting an external amplifier.....	16
Using REMOTE IN/OUT jacks.....	17
Connecting a Yamaha iPod universal dock or Bluetooth™ wireless audio receiver.....	17
Using the VIDEO AUX jacks on the front panel.....	17
Connecting the FM and AM antennas.....	18
Connecting the power cable.....	18
Turning this unit on and off.....	18
Optimizing the speaker setting for your listening room (YPAO).....	19
Using Auto Setup.....	19
When an error message is displayed during measurement.....	21
When a warning message is displayed after measurement.....	21

## BASIC OPERATION

Playback.....	22
Basic procedure.....	22
Using the SCENE function.....	22
Muting audio output temporarily (MUTE).....	23
Adjusting high/low frequency sound (tone control).....	23
Enjoying pure hi-fi sound.....	23
Using your headphones.....	23
Displaying input signal information.....	24
Changing information on the front panel display.....	24
Using the sleep timer.....	24
Enjoy the sound field programs.....	25
Selecting sound field programs.....	25
Enjoying unprocessed input sources (Straight decoding mode).....	28
Enjoying sound field programs without surround speakers (Virtual CINEMA DSP).....	28
Enjoy sound field programs with headphones (SILENT CINEMA™).....	28
Using CINEMA DSP 3D mode.....	28
FM/AM tuning.....	29
Tuning in to the desired FM/AM station (Frequency tuning).....	29
Registering FM/AM stations and tuning in (Preset tuning).....	29
XM® Satellite Radio tuning (U.S.A. model only) .....	31
Connecting XM Mini-Tuner Home Dock.....	31
Activating XM Satellite Radio.....	31
XM Satellite Radio® operations.....	32
Registering XM Satellite Radio channels.....	33
Displaying the XM Satellite Radio™ information.....	34

SIRIUS Satellite Radio™ tuning (U.S.A. model only).....	35
Connecting the SiriusConnect™ tuner.....	35
Activating SIRIUS Satellite Radio™ subscription.....	35
SIRIUS Satellite Radio™ operations.....	35
Registering the SIRIUS Satellite Radio™ channels .....	37
Setting the Parental Lock.....	38
Displaying the SIRIUS Satellite Radio™ information .....	39
Using iPod™.....	40
Controlling iPod™.....	40
Using Bluetooth™ components.....	42
Pairing the Bluetooth™ wireless audio receiver and your Bluetooth component.....	42
Playback of the Bluetooth™ component.....	42

## ADVANCED OPERATION

Setting the option menu for each input source (OPTION menu).....	43
OPTION menu items.....	43
Outputting a video signal input from another input source during reproducing a multi-channel audio signal.....	45
Editing surround decoders/sound field programs .....	46
Selecting a decoder used with a sound field program .....	46
Setting sound field parameters.....	46
Sound field parameters.....	46
Operating various settings for this unit (Setup menu).....	50
Basic operation of the setup menu.....	51
Speaker Setup.....	51
Sound Setup.....	53
Function Setup.....	54
DSP Parameter.....	56
Memory Guard.....	56
Using multi-zone configuration.....	57
Connecting Zone2.....	57
Controlling Zone2.....	58
Controlling other components with the remote control.....	59
Setting remote control codes.....	59
Resetting all remote control codes.....	59
Advanced setup.....	60

## APPENDIX

Troubleshooting.....	61
General.....	61
HDMI.....	64
Tuner (FM/AM).....	64
XM Satellite Radio (U.S.A. model only).....	65
SIRIUS Satellite Radio (U.S.A. model only).....	66
Remote control.....	67
iPod™.....	68
Bluetooth™.....	68
Auto Setup (YPAO).....	69
Glossary.....	71
Sound field program information.....	73
Information on HDMI™.....	74
Specifications.....	75
Index.....	76

(at the end of this manual)

List of remote control codes.....	i
-----------------------------------	---

# INTRODUCTION

## Features

### ■ Built-in 7-channel power amplifier

- Minimum RMS Output Power (1 kHz, 0.9% THD, 8 Ω)
- FRONT L/R: 90 W + 90 W
- CENTER: 90 W
- SURROUND L/R: 90 W + 90 W
- SURROUND BACK L/R: 90 W + 90 W

### ■ Speaker/Preout outputs

- Speaker jacks (7-channel), preout output jacks (7.1-channel)

### ■ Input/Output terminals

#### Input terminals

- HDMI input x 4
- Audio/Visual input
  - [Audio] Digital input (coaxial) x 2, digital input (optical) x 2, analog input x 2
  - [Video] Component video x 2, composite video x 4
- Audio input (analog) x 2
- Dock input x 1
- V-AUX input
  - [Audio] Analog x 1
  - [Video] Composite video x 1

#### Output terminals

- Monitor output
  - [Audio/Video] HDMI x 1
  - [Video] Component video x 1, Composite video x 1
- Audio/Visual output
  - [Audio] Analog x 1
  - [Video] Composite video x 1
- Audio output
  - Analog x 1
- Zone2 output
  - Analog x 1

#### Other terminals

Remote input x 1, Remote output x 1  
Trigger output x 1

### ■ Proprietary Yamaha technology for the creation of sound fields

- CINEMA DSP 3D
- Compressed Music Enhancer mode
- Virtual CINEMA DSP
- SILENT CINEMA

### ■ Digital audio decoders

- Dolby TrueHD, Dolby Digital Plus decoder
- DTS-HD Master Audio, DTS-HD High Resolution Audio, DTS Express
- Dolby Digital/Dolby Digital EX decoder
- DTS, DTS 96/24 decoder, DTS-ES Matrix 6.1, DTS-ES Discrete 6.1
- Dolby Pro Logic/Dolby Pro Logic II/Dolby Pro Logic IIx decoder
- DTS NEO:6 decoder

- Neural Surround decoder (U.S.A. model only)

### ■ Radio tuners

- FM/AM tuning capability
- XM Satellite Radio tuning capability, using XM Mini-Tuner and Home Dock, sold separately (U.S.A. model only).
- SIRIUS Satellite Radio tuning capability, using SiriusConnect tuner, sold separately (U.S.A. model only).

### ■ HDMI™

#### (High-Definition Multimedia Interface)

- HDMI interface for standard, enhanced or high-definition video as well as multi-channel digital audio.
  - Automatic audio and video synchronization (lip sync) information capability
  - Deep Color video signal (30/36 bit) transmission capability
  - “x.v.Color” video signal transmission capability
  - High refresh rate and high resolution video signals capability
  - High definition digital audio format signals capability
- Analog video to HDMI digital video up-conversion (composite video → HDMI, component video → HDMI) capability for monitor out
- Analog video input up-scaling for HDMI digital video output 480i or 480p → 720p, 1080i or 1080p

### ■ DOCK terminal

- DOCK terminal to connect a Yamaha iPod universal dock (such as YDS-11, sold separately) or Bluetooth wireless audio receiver (such as YBA-10, sold separately)





### ■ Automatic speaker setup features

- “YPAO” (Yamaha Parametric Room Acoustic Optimizer) for automatically optimizing speaker outputs suitable for listening environments.

### ■ Other features

- 192-kHz/24-bit D/A converter
- OSD (on-screen display) menus that allow you to optimize this unit to suit your individual audiovisual system
- Pure Direct mode for pure hi-fi sound for all sources
- Adaptive dynamic range controlling capability
- Sleep timer
- Multi-zone function

# About this manual

-  indicates a tip for your operation.
- Some operations can be performed by using either the keys on the front panel or the ones on the remote control. In case the key names differ between the front panel and the remote control, the key name on the remote control is given in parentheses.
- This manual is printed prior to production. Design and specifications are subject to change in part as a result of improvements, etc. In case of differences between the manual and product, the product has priority.
- “ **MAIN ZONE ON/OFF**” or “ **HDMI 1**” (example) indicates the name of the parts on the front panel or the remote control. Refer to the attached sheet or the pages at the end of this manual for the information about each position of the parts.
-  indicates the page describing the related information.



Manufactured under license from Dolby Laboratories.  
Dolby, Pro Logic and the double-D symbol are trademarks of Dolby Laboratories



Manufactured under license under U.S. Patent No's:  
5,451,942;5,956,674;5,974,380;5,978,762;6,226,616;6,487,535 &  
other U.S. and worldwide patents issued & pending. DTS is a  
registered trademark and the DTS logos, Symbol, DTS-HD and DTS-  
HD Master Audio are trademark of DTS, Inc. © 1996-2007 DTS, Inc.  
All Rights Reserved.



Neural Surround™ name and related logos are trademarks owned  
by Neural Audio Corporation.

### iPod™

“iPod” is a trademark of Apple Inc., registered in the U.S. and other  
countries.

### Bluetooth™

Bluetooth is a registered trademark of Bluetooth SIG and is used by  
Yamaha in accordance with a license agreement.

## HDMI

“HDMI,” the “HDMI” logo and “High-Definition Multimedia  
Interface” are trademarks, or registered trademarks of HDMI  
Licensing LLC.

### x.v.Color™

“x.v.Color” is a trademark of Sony Corporation. “SILENT CINEMA”  
is a trademark of Yamaha Corporation.

### SILENT™ CINEMA

“SILENT CINEMA” is a trademark of Yamaha Corporation.



SIRIUS, XM and all related marks and logos are trademarks of Sirius  
XM Radio Inc. and its subsidiaries. All rights reserved. **Service not  
available in Alaska and Hawaii.**

## Supplied accessories

Check that you received all of the following parts.

- Remote control
- Batteries (2) (AAA, R03, UM-4)
- Optimizer microphone
- AM loop antenna
- Indoor FM antenna

# Part names and functions

## Front panel

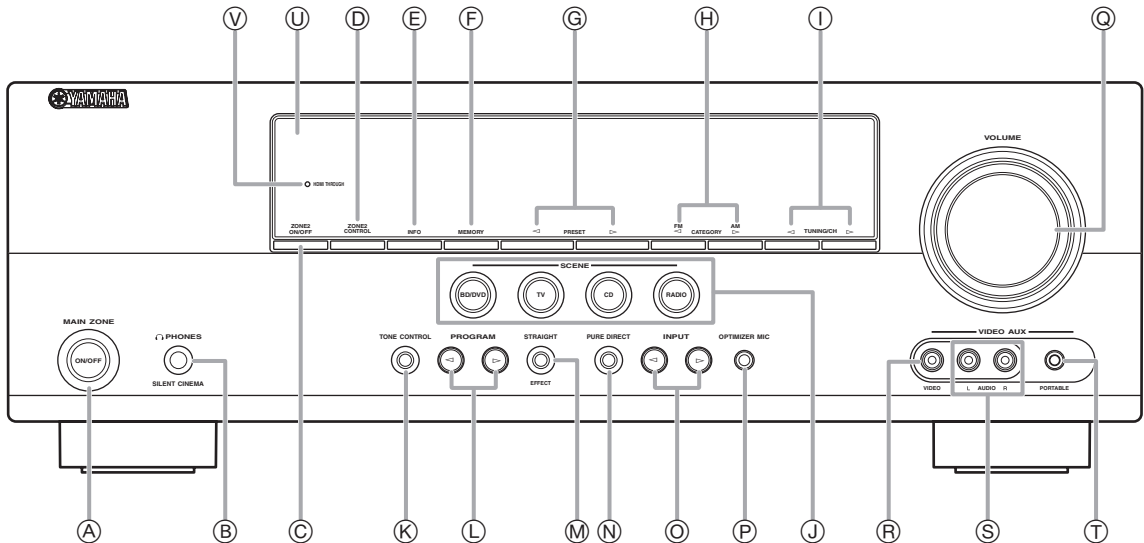

- (A) MAIN ZONE ON/OFF**  
Switches this unit between on and off (see page 18).
- (B) PHONES jack**  
For plugging headphones (see page 23).
- (C) ZONE2 ON/OFF**  
Switches the zone function on and off (see page 58).
- (D) ZONE2 CONTROL**  
Enables operation of a receiver set in Zone2, including input source switching, volume control and tuner operation, with the main amplifier or remote control after this key is pressed.
- (E) INFO**  
Changes information display screens on the front panel display (see page 24).
- (F) MEMORY**  
Registers FM/AM stations as preset stations (see page 30) or XM/SIRIUS channels as preset channels (see page 33).
- (G) PRESET </>**  
Selects an FM/AM preset station (see page 30) or an XM/SIRIUS preset channel (see page 33).
- (H) FM/AM (CATEGORY </>)**  
Change the tuner bands between FM and AM.  
Select a channel category for a XM/SIRIUS.
- (I) TUNING/CH </>**  
Changes FM/AM frequencies or XM/SIRIUS tuner channels.
- (J) SCENE**  
Switches between linked sets of input sources and sound field programs (see page 22).
- (K) TONE CONTROL**  
Adjusts high-frequency/low-frequency output of speakers (see page 22).
- (L) PROGRAM </>**  
Changes sound field programs (see page 25).
- (M) STRAIGHT**  
Changes a sound field program to straight decoding mode (see page 28).
- (N) PURE DIRECT**  
Changes mode to Pure Direct mode (see page 23). This key lights up when Pure Direct mode is on.
- (O) INPUT </>**  
Selects an input source (see page 22).
- (P) OPTIMIZER MIC jack**  
For connecting the supplied optimizer microphone and adjusting output characteristics of speakers (see page 19).
- (Q) VOLUME control**  
Controls the volume of this unit (see page 22).
- (R) VIDEO (VIDEO AUX) jack**  
For connecting the video output cable of a camcorder or game console (see page 17).
- (S) AUDIO L/R (VIDEO AUX) jack**  
For connecting the audio output cable of a camcorder or game console (see page 17).
- (T) PORTABLE (VIDEO AUX) jack**  
For connecting the audio output cable of a portable music player (see page 17).
- (U) Front panel display**  
Displays information on this unit (see page 6).
- (V) HDMI THROUGH**  
Lights up during pass-through output of an HDMI signal input to this unit while this unit is on standby (see page 54).



## Rear panel

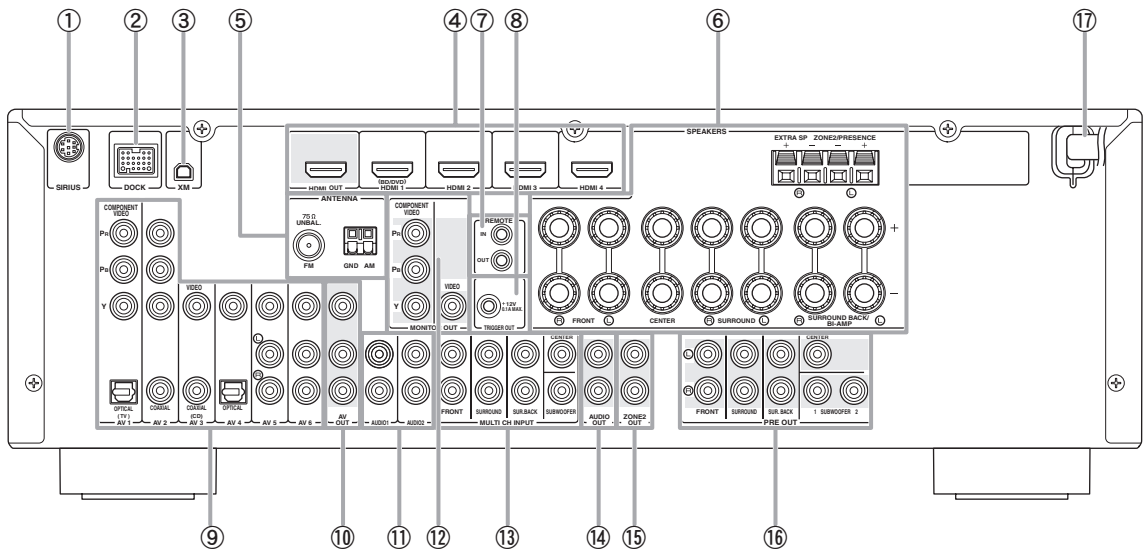

- ① **SIRIUS terminal**  
For connecting a SiriusConnect tuner (separately sold) (see page 35).
- ② **DOCK terminal**  
For connecting an optional Yamaha iPod universal dock (YDS-11) or Bluetooth wireless audio receiver (YBA-10) (see page 17).
- ③ **XM terminal**  
For connecting XM Mini-Tuner in XM Mini-Tuner Home Dock (separately sold) (see page 31).
- ④ **HDMI OUT/HDMI 1-4**  
For connecting an HDMI-compatible video monitor or external components for HDMI inputs 1-4 (see page 15).
- ⑤ **ANTENNA jack**  
For connecting supplied FM and AM antennas (see page 18).
- ⑥ **SPEAKERS terminal**  
For connecting front right and left, center, surround and surround back speakers (see page 11). Connect the presence speakers (see page 11) or the speakers for Zone2 (see page 57) to EXTRA SP terminals.
- ⑦ **REMOTE IN/OUT terminals**  
For connecting an external component that supports the remote control function (see page 17).
- ⑧ **TRIGGER OUT terminal**  
For connecting an external terminal with a trigger input terminal to operate it linked with operation of this unit. For example, when an electric screen that supports a trigger input is connected, it opens and closes linked with operation of an input source selected in this unit.
- ⑨ **AV 1-6**  
For connecting external components for audio/visual inputs 1-6 (see page 15).
- ⑩ **AV OUT**  
Outputs audio/visual signals from a selected analog input source to an external component (see page 16).
- ⑪ **AUDIO 1/2**  
For connecting external components for audio inputs 1-2 (see page 16).
- ⑫ **MONITOR OUT**  
Outputs visual signals from this unit to a video monitor, such as a TV (see page 14).
- ⑬ **MULTI CH INPUT terminals**  
For connecting a player that supports a multi-channel output (see page 16).
- ⑭ **AUDIO OUT**  
Outputs audio signals from a selected analog input source to an external component (see page 16).
- ⑮ **ZONE2 OUT jacks**  
Outputs sound of this unit to an external amplifier set in a different zone.
- ⑯ **PRE OUT**  
Outputs multi-channel signals from up to 7.1 channels to an external amplifier (see page 16).
- ⑰ **Power Cable**  
Connect this cable to an AC wall outlet (see page 18).

## Front panel display

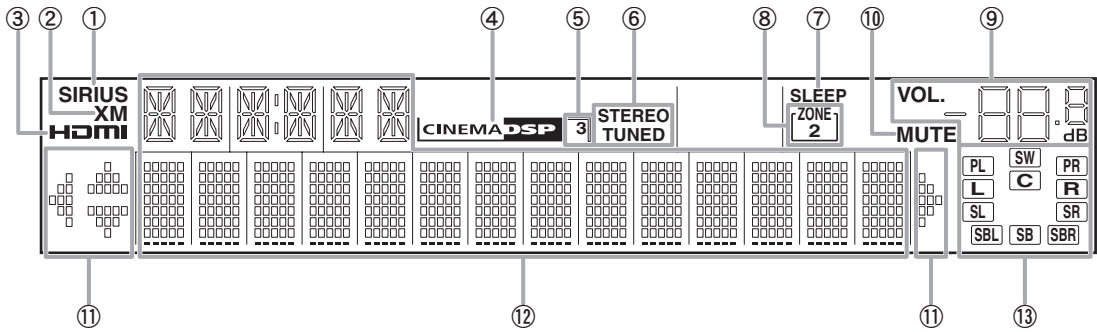

- ① **SIRIUS indicator**  
Lights up when a SiriusConnect tuner is selected as an input source.
- ② **XM indicator**  
Lights up when an XM tuner is selected as an input source.
- ③ **HDMI indicator**  
Lights up during normal communication when HDMI is selected as an input source.
- ④ **CINEMA DSP indicator**  
Lights up when a sound field program that uses CINEMA DSP is selected.
- ⑤ **CINEMA DSP 3D indicator**  
Lights up when CINEMA DSP 3D is activated.
- ⑥ **Tuner indicator**  
Lights up during receiving radio broadcast signals from an FM/AM station (see page 29).
- ⑦ **SLEEP indicator**  
Lights up when the sleep timer is activated (see page 24).
- ⑧ **ZONE2 indicator**  
Lights up when the zone functions is turned on.
- ⑨ **VOLUME indicator**  
Displays volume levels.
- ⑩ **MUTE indicator**  
Flashes when audio is muted.
- ⑪ **Cursor indicators**  
Light up if corresponding cursors on the remote control are available for operations.
- ⑫ **Multi information display**  
Displays menu items and settings for the current operation.
- ⑬ **Speaker indicators**  
Indicate speaker terminals from which signals are currently output.

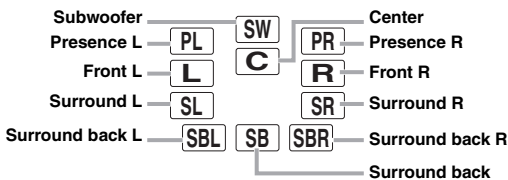

## Remote control

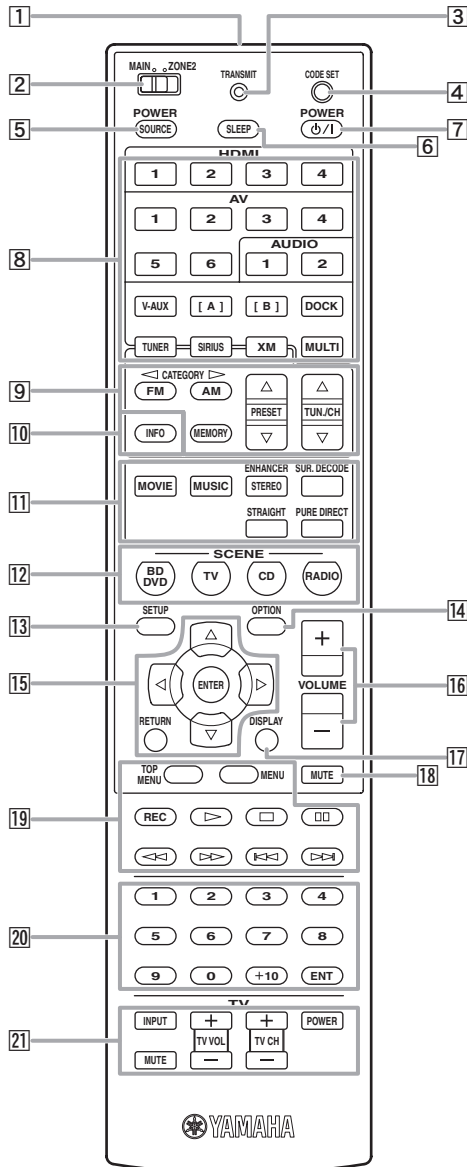

- 1 Remote control signal transmitter**  
Transmits infrared signals.
- 2 MAIN/ZONE2**  
Switches amplifiers (Main or Zone2) to be operated by the remote control (see page 58).
- 3 TRANSMIT**  
Lights up when a signal is output from the remote control.
- 4 CODE SET**  
Sets remote control codes for external component operations (see page 59).
- 5 SOURCE POWER**  
Switches an external component on and off.
- 6 SLEEP**  
Switches the sleep timer operations (see page 24).
- 7 POWER**  
Switches this unit on and standby.

- 8 Input selection keys**
- HDMI 1-4** Selects HDMI inputs 1 through 4.
- AV 1-6** Selects AV inputs 1 through 6.
- AUDIO 1/2** Selects AUDIO inputs 1 and 2.
- V-AUX** Selects the V-AUX jack on the front panel of this unit.
- [A]/[B]** To control external components using the external control keys separately from operations of this unit (see page 59).
- DOCK** Selects a Yamaha iPod universal dock/Bluetooth wireless audio receiver connected to the DOCK jack.
- TUNER** Selects the FM/AM tuner.
- SIRIUS** Selects a SiriusConnect tuner as an input source.
- XM** Selects an XM tuner as an input source.
- MULTI** Selects a signal input from the MULTI CH INPUT jack on the rear panel as an input source.
- 9 Tuner keys**
- FM** Switches a band between FM and AM.
- AM**
- (CATEGORY </>)** Select a channel category for a XM/SIRIUS.
- MEMORY** Presets radio stations.
- PRESET  $\Delta$  /  $\nabla$**  Selects a preset station.
- TUN./CH  $\Delta$  /  $\nabla$**  Changes FM/AM frequencies or XM/SIRIUS tuner channels.
- 10 INFO**  
Changes the information shown on the front panel display (see page 24).
- 11 Sound selection keys**  
Selects sound field programs (see page 25).
- 12 SCENE**  
Switches between linked sets of input sources and sound field programs (see page 22).
- 13 SETUP**  
Displays the setup menu (see page 51).
- 14 OPTION**  
Displays the option menu (see page 43).
- 15 Cursors  $\Delta$  /  $\nabla$  /  $\triangleleft$  /  $\triangleright$  / ENTER / RETURN**
- Cursors  $\Delta$  /  $\nabla$  /  $\triangleleft$  /  $\triangleright$**  Select menu items displayed on the front panel display or on a video monitor, or change settings.
- ENTER** Confirms a selected item.
- RETURN** Returns to the previous screen or ends the menu display.
- 16 VOLUME +/-**  
Adjust the volume of this unit (see page 22).
- 17 DISPLAY**  
Displays or not display the OSD on the video monitor  
When an iPod is connected: Changes the operation mode of the iPod connected to the Yamaha iPod universal dock (see page 40).
- 18 MUTE**  
Turns the mute function of the sound output on and off (see page 23).
- 19 External component operation keys**  
Operate recording, playback etc. of external components (see page 59).
- 20 Numeric keys**  
Enter numbers.
- 21 TV control keys**  
Enables operations of a monitor such as a TV and a projector.

# Quick start guide

When you use this product for the first time, perform setup following the steps below. See the related pages for details on operations and settings.

## Step 1: Prepare items for setup

Prepare speakers, DVD player, cables, and other items necessary for setup.

For example, prepare the following items for setting up a 5.1-channel sound system.

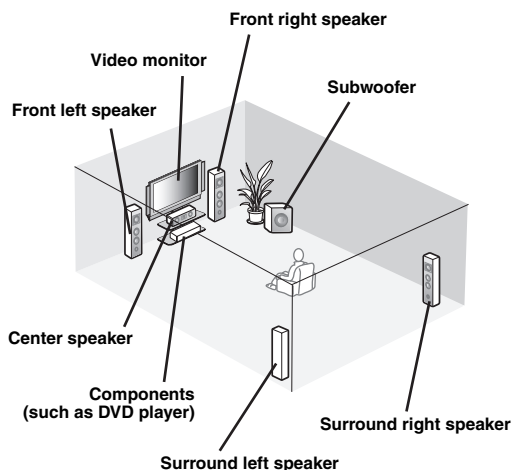

Requirements		qty.
Speakers	Front speaker	2
	Center speaker	1
	Surround speaker	2
Active subwoofer		1
Speaker cable		5
Subwoofer cable		1
Reproduction component such as DVD player		1
Video monitor such as TV		1
Video cable or HDMI cable		2
Audio cable		2



- Prepare two magnetically shielded speakers (for front). The priority of the requirement of other speakers is as follows:
  - Two surround speakers
  - One center speaker
  - One (or two) surround back speaker(s)
- If your video monitor is a CRT, we recommend that you use magnetically shielded speakers.

## Step 2: Set up your speakers

Place your speakers in the room and connect them to this unit.

- Placing speakers P. 10
- Connecting speakers P. 11



- This unit has a YPAO (Yamaha Parametric Room Acoustic Optimizer) that automatically optimizes this unit based on room acoustic characteristics (audio characteristics of the speakers, speaker positions, and room acoustics, etc.). You can enjoy good balanced sound without special knowledge by using the YPAO technology (see page 19).

## Step 3: Connect your components

Connect your TV, DVD player, or other components.

- Connecting a TV monitor or projector P. 14
- Connecting other components P. 15
- Connecting a multi-format player or an external decoder P. 16
- Connecting an external amplifier P. 16
- Connecting a Yamaha iPod universal dock or Bluetooth wireless audio receiver P. 17
- Connecting the FM and AM antennas P. 18
- Connecting an XM Mini-Tuner Home Dock P. 31
- Connecting a SiriusConnect tuner P. 35

## Step 4: Turn on the power

Connect the power cable and turn on this unit.

- Connecting the power cable P. 18
- Turning this unit on and off P. 18

## Step 5: Select the input source and start playback

Select the component connected in the step 3 as an input source and start playback.

- Basic procedure P. 22
- Selecting sound field programs P. 25



- This unit supports the SCENE function that changes the input source and sound field program at one time. Four scenes are preset for different purposes for Blu-ray disc, DVD and CD, and you can select from a scene from those just by pressing a remote control key. See page 22 for details.

# PREPARATION

## Preparing remote control

### Installing batteries in the remote control

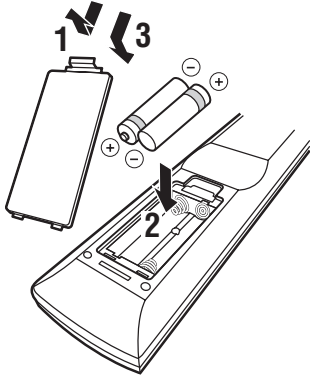

- 1 Take off the battery compartment cover.**
- 2 Insert the two supplied batteries (AAA, R03, UM-4) according to the polarity markings (+ and -) on the inside of the battery compartment.**
- 3 Snap the battery compartment cover back into place.**

#### Notes

- Change all batteries if you notice the following conditions:
  - the operation range of the remote control narrows
  - the transmit indicator does not flash or is dim
- Do not use old batteries together with new ones.  
This may shorten the life of the new batteries or cause old batteries to leak.
- Do not use different types of batteries (such as alkaline and manganese batteries) together. Specification of batteries may be different even though they look the same.
- If you find leaking batteries, discard the batteries immediately, taking care not to touch the leaked material. If the leaked material comes into contact with your skin or gets into your eyes or mouth, rinse it away immediately and consult a doctor. Clean the battery compartment thoroughly before installing new batteries.
- Dispose of the old batteries correctly in accordance with your local regulations.
- If the remote control is without batteries for more than 2 minutes, or if exhausted batteries remain in the remote control, the contents of the memory may be cleared. In such a case, install new batteries and set the remote control code.

### Using the remote control

The remote control transmits a directional infrared ray. Be sure to aim the remote control directly at the remote control sensor on this unit during operation.

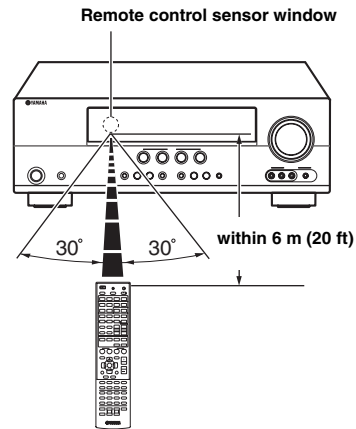

#### Notes

- Do not spill water or other liquids on the remote control.
- Do not drop the remote control.
- Do not leave or store the remote control in the following conditions:
  - places of high humidity, such as near a bath
  - places of high temperatures, such as near a heater or stove
  - places of extremely low temperatures
  - dusty places
- ☀️ You can operate external components with this remote control by setting the remote control code. See page 59 for details.

## Placing speakers

This unit supports up to 7.1-channel surround. We recommend the following speaker layout in order to obtain the optimum surround effect.

### 7.1-channel speaker layout

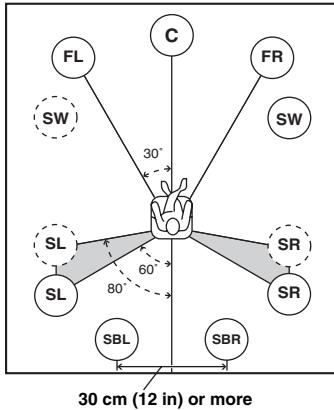

### 6.1-channel speaker layout

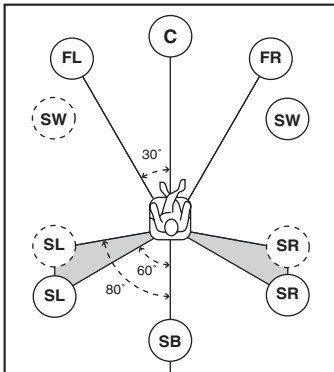

### 5.1-channel speaker layout

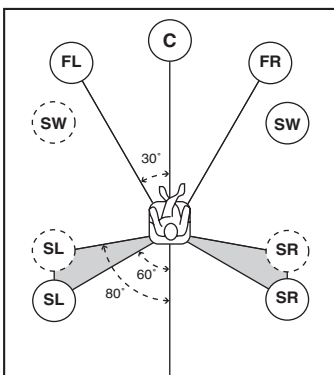

### Speaker channels

#### ■ Front left and right speakers (FL and FR)

The front speakers are used for the front channel sounds (stereo sound) and effect sounds. Place these speakers at an equal distance from the ideal listening position. When using a screen, the appropriate top positions of the speakers are about 1/4 of the screen from the bottom.

#### ■ Center speaker (C)

The center speaker is for the center channel sounds (dialog, vocals, etc.). Place it halfway between the left and right speakers. When using a TV, place the speaker just above or just under the center of the TV with the front surfaces of the TV and the speaker aligned. When using a screen, place it just under the center of the screen.

#### ■ Surround left and right speakers (SL and SR)

The surround speakers are used for effect and surround sounds.

Place them at the rear left and rear right facing the listening position.

To obtain a natural sound flow in the 5.1-channel speaker layout, place them slightly further back than in the 7.1-channel speaker layout.

#### ■ Surround back left and right speakers (SBL and SBR) / Surround back speaker (SB)

The surround back left and right speakers are used for rear effect sounds. Place them at the rear of the room facing the listening position at least 30 cm away from each other, ideally at the same distance as that between the front left and right speakers.

In the 6.1-channel speaker layout, surround back left and right channel sound signals are mixed down and output from the single surround back speaker.

In the 5.1-channel speaker layout, surround back left and right channel sound signals are output from the surround left and right speakers.

#### ■ Subwoofer (SW)

The subwoofer speaker is used for bass sounds and low-frequency effect (LFE) sounds included in Dolby Digital and DTS signals. Use a subwoofer with a built-in amplifier, such as the Yamaha Active Servo Processing Subwoofer System. Place it exterior to the front left and right speakers facing slightly inward to reduce reflections from a wall.

## ■ Presence left and right speakers (PL and PR)

The presence speakers supplement the sound from the front speakers with extra ambient effects produced by the sound field programs (see page 25). We recommend that you use the presence speakers especially for the CINEMA DSP sound field programs. To use the presence speakers, connect the speakers to EXTRA SP terminals and then set “Extra SP Assign” to “Presence” (see page 51).

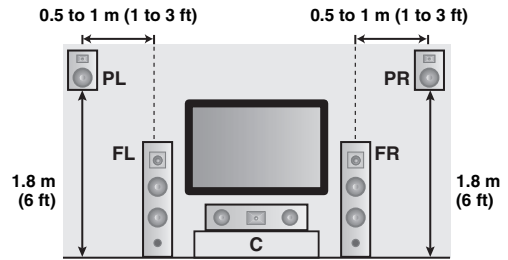

## Connecting speakers

When you connect speakers, connect them to the respective terminals as follows, according to your speaker layout.



- Connect optional presence speakers or Zone2 speakers (see page 57) to the EXTRA SP jacks.
- You can connect up to two subwoofers. When two subwoofers are connected, the same sound is output from them.

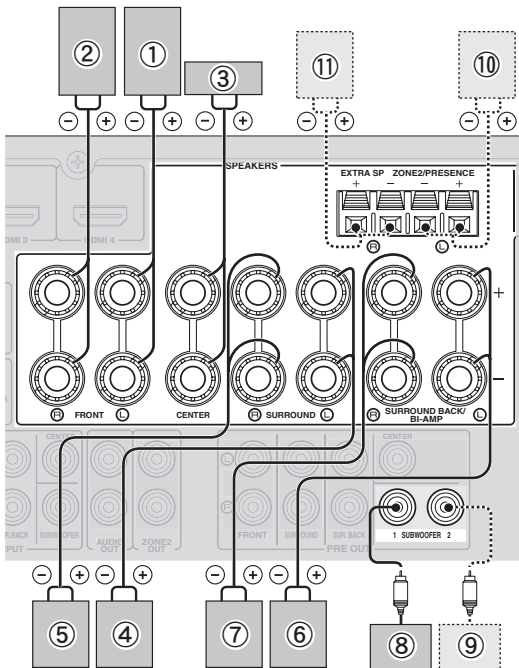

## ■ 9.1-channel (When using presence speakers)

Speakers	Jacks on this unit
① Front speaker L	FRONT (L)
② Front speaker R	FRONT (R)
③ Center speaker	CENTER
④ Surround speaker L	SURROUND (L)
⑤ Surround speaker R	SURROUND (R)
⑥ Surround back speaker L	SURROUND BACK/BI-AMP (L)
⑦ Surround back speaker R	SURROUND BACK/BI-AMP (R)
⑧ Subwoofer 1	SUB WOOFER 1
⑨ Subwoofer 2 (optional)	SUB WOOFER 2
⑩ Presence speaker L (optional)	EXTRA SP (L)
⑪ Presence speaker R (optional)	EXTRA SP (R)

## ■ 6.1-channel (When using the Multi-zone function)

Speakers	Jacks on this unit
① Front speaker L	FRONT (L)
② Front speaker R	FRONT (R)
③ Center speaker	CENTER
④ Surround speaker L	SURROUND (L)
⑤ Surround speaker R	SURROUND (R)
⑥ Surround back speaker	SURROUND BACK/BI-AMP (L)
⑧ Subwoofer 1	SUB WOOFER 1
⑨ Subwoofer 2 (optional)	SUB WOOFER 2
⑩ Zone2 speaker L (optional)	EXTRA SP (L)
⑪ Zone2 speaker R (optional)	EXTRA SP (R)

## ■ 5.1-channel (When using the Multi-zone function)

Speakers	Jacks on this unit
① Front speaker L	FRONT (L)
② Front speaker R	FRONT (R)
③ Center speaker	CENTER
④ Surround speaker L	SURROUND (L)
⑤ Surround speaker R	SURROUND (R)
⑧ Subwoofer 1	SUB WOOFER 1
⑨ Subwoofer 2 (optional)	SUB WOOFER 2
⑩ Zone2 speaker L (optional)	EXTRA SP (L)
⑪ Zone2 speaker R (optional)	EXTRA SP (R)

## Connecting the speaker cable

### Caution

- A speaker cable is a pair of insulated cables running side by side in general. One of the cables is colored differently or striped to indicate a polarity. Connect one end of the colored/striped cable to the “+” (red) terminal of this unit and the other end to that of your speaker, and connect one end of the other cable to the “-” (black) terminal of this unit and the other end to that of your speaker.
- Before connecting the speakers, be sure to disconnect the power cable.
- Do not let the bare speaker wires touch each other or any metal part of this unit. This could damage this unit and/or speakers. If the circuit shorts out, “CHECK SP WIRES!” appears on the front panel display when this unit is turned on.
- Use magnetically shielded speakers. If images on the monitor are still distorted even when you use the magnetically shielded speakers, place the speakers away from the monitor.
- Use speakers with an impedance of 6-ohm or larger. Set speaker impedance in “ADVANCED SETUP” before connecting the speakers (see page 60).

### ■ Connecting to the FRONT, CENTER, SURROUND and SURROUND BACK/BI-AMP terminals

- 1 Remove approximately 10 mm (0.4 in) of insulation from the end of each speaker cable and then twist bare wires of the cable together so that they will not cause a short circuits.

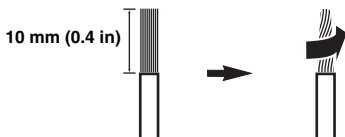

- 2 Loosen the knob, insert the twisted bare wires into the hole, and then tighten the knob.

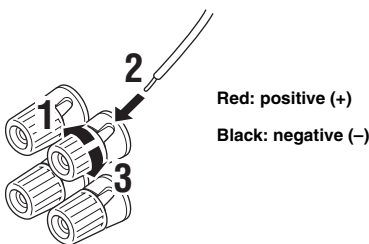

### Connecting the banana plug (Except U.K., Europe, Asia and Korea models)

Tighten the knob, and then insert the banana plug into the end of the terminal.

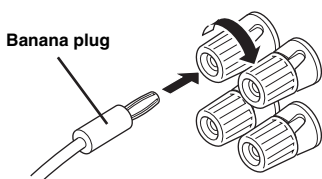

### ■ Connecting to the EXTRA SP terminals

- 1 Press down the tab and insert the bare end of the speaker cable into the hole in the terminal.

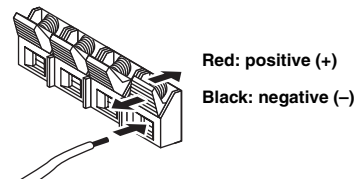

- You can connect the presence speakers (see page 11) or the speakers in the second zone (Zone2) (see page 57) to EXTRA SP terminals.

- 2 Release the tab to secure the wire.

### Using bi-amplification connections

You can connect speakers that support bi-amplification connections to this unit. Before connecting the speakers, set this unit to enable bi-amplification connections in “ADVANCED SETUP” (see page 60), and connect the speakers to this unit as shown below.

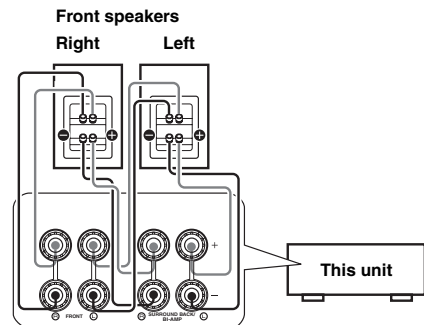

### Caution

Before making bi-amplification connections, remove any or cables that connect a woofer with a tweeter. Refer to the instruction manuals of speakers for details. When not making bi-amplification connections, make sure that the brackets or cables are connected before connecting the speaker cables.



## Information on jacks and cable plugs

This unit has the following input and output jacks. Use jacks and cables appropriate for components that you are connecting.

### ■ Audio jacks

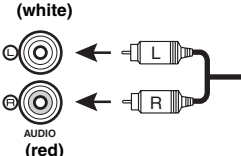
Jack and cables	Description
<b>AUDIO jacks</b> (white) 	To transmit conventional analog left and right audio signals. Use stereo pin cables. Connect red plugs to red jacks (R) and white plugs to white jacks (L).

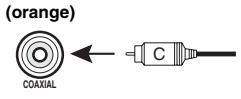
<b>COAXIAL jacks</b> (orange) 	To transmit coaxial digital audio signals. Use pin cables for digital audio signals.
---	--

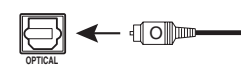
<b>OPTICAL jacks</b> 	To transmit optical digital audio signals. Use optical fiber cables for optical digital audio signals.
---	--

### ■ Video jacks

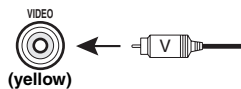
Jack and cables	Description
<b>VIDEO jacks</b> VIDEO (yellow) 	To transmit conventional composite video signals. Use video pin cables.

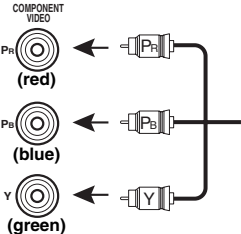
<b>COMPONENT VIDEO jacks</b> COMPONENT VIDEO Pr (red) Pb (blue) Y (green) 	To transmit component video signals that include luminance (Y), chrominance blue (PB) and chrominance red (PR) components. Use component video cables.
--	--

### ■ Video/audio jacks

Jack and cables	Description
<b>HDMI jacks</b> 	To transmit digital video and digital audio signals. Use HDMI cables.



- We recommend that you use a commercially available 19-pin HDMI cable no longer than 5 meters (16 feet) with the HDMI logo printed on it.
- You can check the potential problem about the HDMI connection (see page 74).
- You can check error information on HDMI connections (see page 74).

A video signal input to this unit is output from the output terminals in MONITOR OUT for the same kind of signal as the input signal.

For example, if a VCR with a composite output signal and a DVD player with a COMPONENT VIDEO output signal are connected, connect both VIDEO jack and COMPONENT VIDEO jack in MONITOR OUT to the video monitor.

If an HDMI input compatible monitor is connected, this unit automatically converts an analog signal that is input from a video input terminal to a digital video signal, and then output it from the HDMI OUT jack.

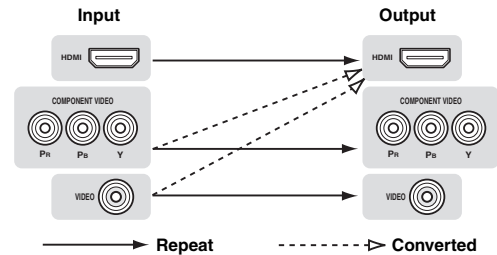

## Connecting a TV monitor or projector

Connect a video monitor such as a TV or projector to an output terminal of this unit. You can select one of the following three types according to the input signal format supported by the video monitor.

### Note

- When you connect this unit to the video monitor, make sure that this unit is on standby.

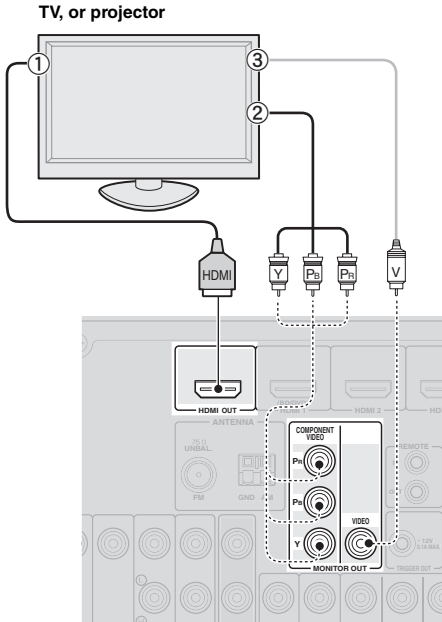

### ■ To connect an HDMI video monitor

Jacks on components	Jacks on this unit
① HDMI input	HDMI OUT

### ■ To connect component video monitor

#### Note

- Only video signals input from this unit via the component input terminal are output from the component output terminal.

Jacks on components	Jacks on this unit
② Component video output	MONITOR OUT (COMPONENT VIDEO)

### ■ To connect composite video monitor

#### Note

- Only video signals input from this unit via the composite video input terminal are output from the composite video output terminal.

Jacks on components	Jacks on this unit
③ Video input (composite)	MONITOR OUT (VIDEO)

## Outputting sound of a TV from this unit

To output sound of a TV from this unit, make connection between the AV input 1-6 and an audio output terminal. If the TV supports an optical digital output, we recommend that you use the AV input 1. Connecting to the AV input 1 allows you to switch an input source to the AV input 1 with a just a single key operation using the SCENE function (see page 22).

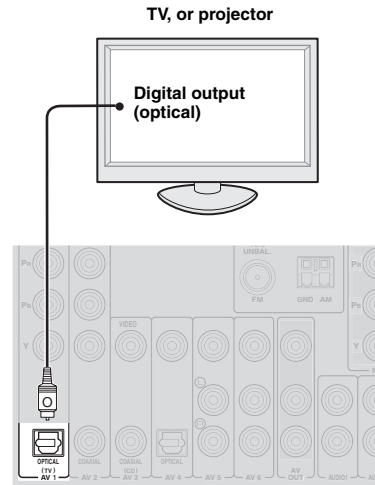

## Connecting other components

This unit has input and output terminals for respective input and output sources. You can reproduce sound and movies from input sources selected with the front panel display or remote control.

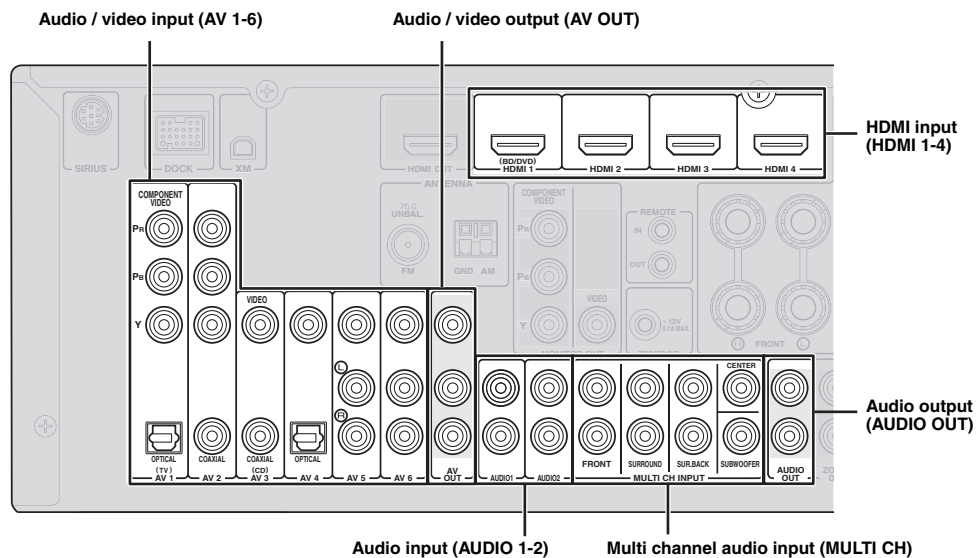

### ■ Audio and video player / Set-top box

Output jacks on the connected external component			Input sources/jacks of this unit	
External components	Signals	Output jacks		
External component with HDMI output	Audio/Video	HDMI output	HDMI 1 (BD/DVD)	HDMI 1
			HDMI 2	HDMI 2
			HDMI 3	HDMI 3
			HDMI 4	HDMI 4
External component with component video output	Audio	Optical digital output	AV 1 (TV)	OPTICAL
		Component video		COMPONENT VIDEO
	Video	Coaxial digital output	AV 2	COAXIAL
		Component video output		COMPONENT VIDEO
External component with composite video output	Audio	Coaxial digital output	AV 3 (CD)	COAXIAL
		Composite output		VIDEO
	Video	Optical digital output	AV 4	OPTICAL
		Composite output		VIDEO
	Audio	Analog audio output	AV 5	AUDIO
		Composite output		VIDEO
	Video	Analog audio output	AV 6	AUDIO
		Composite output		VIDEO



- Input sources in parentheses are recommended to connect to the respective jacks. If your Yamaha component has the Remote in/out terminal, you can switch the input source to that component with a single key operation using the SCENE function (see page 22).
- You can change the name of the input source displayed on the front panel display or the OSD on the video monitor as necessary (see page 55).
- See page 57 on how to use ZONE2 OUT terminals.

■ Audio player

Output jacks on the connected external component		Input sources/jacks of this unit	
External components	Output jacks		
External component with optical digital output	Optical digital output	AV 1 (TV)	OPTICAL
		AV 4	OPTICAL
External component with coaxial digital output	Coaxial digital output	AV 2	COAXIAL
		AV 3 (CD)	COAXIAL
External component with analog audio output	Analog audio output	AV 5	AUDIO
		AV 6	AUDIO
		AUDIO 1	AUDIO
		AUDIO 2	AUDIO



- We recommend connecting the coaxial digital output terminal of a CD player to the AV3 jack.

**About audio/video output terminals**

Among the analog audio and analog video signals input to this unit via input terminals, the audio/video signals of the selected input sources are output from the AV OUT jack and AUDIO OUT jack. An HDMI input signal, COMPONENT VIDEO input signal or digital audio input signal cannot be output.

When using the AV OUT jack: connect an external component to the composite or analog audio terminal.

When using the AUDIO OUT jack: connect an external component to the analog audio terminal.

**Connecting a multi-format player or an external decoder**

This unit is equipped with 8 additional input jacks (Front L/R, Center, Surround L/R, Surround Back L/R and SUBWOOFER) for discrete multi-channel input from a multi-format player, external decoder, etc. If you set input source to “MULTI CH,” the analog audio input jacks assigned as “Front Input” can be used as the front channel input jacks.

**Notes**

- When you select “MULTI CH” as the input source, the digital sound field processor is automatically disabled.
- Since this unit does not redirect signals input at the MULTI CH INPUT jacks to accommodate for missing speakers, connect at least a 5.1-channel speaker system when using this feature.
- When the input source is switched to “MULTI CH,” images input from a component connected to “AV1-6” or “V-AUX” (see page 45). If your DVD player does not support multi-channel digital output, connect it to these input jacks.

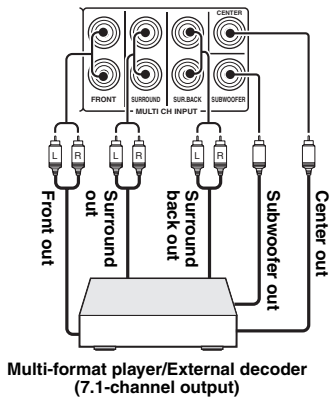

**Connecting an external amplifier**

This unit has more than enough power for any home use. However, if you want to add more power to the speaker output or if you want to use another amplifier, connect an external amplifier to the PRE OUT jacks. Each PRE OUT jack outputs the same channel signals as the corresponding SPEAKERS terminals.

**Note**

- When you make connections to the PRE OUT jacks, do not make any connections to the SPEAKERS terminals.

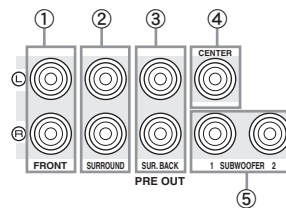

- FRONT PRE OUT jacks**  
Front channel output jacks.
- SURROUND PRE OUT jacks**  
Surround channel output jacks.
- SUR. BACK PRE OUT jacks**  
Surround back output jacks. When you only connect one external amplifier for the surround back channel, connect it to the single SUR. BACK jack.  
 To output surround back channel signals at these jacks, set “Sur. Back” to any parameter except “None” (see page 52).
- CENTER PRE OUT jack**  
Center channel output jack.
- SUBWOOFER PRE OUT 1/2 jack**  
Connect a subwoofer with a built-in amplifier.

## Using REMOTE IN/OUT jacks

When the components are the Yamaha products and have the capability of the transmission of the remote control signals, connect the REMOTE IN and REMOTE OUT jacks to the remote control input and output jack with the monaural analog mini cable as follows.

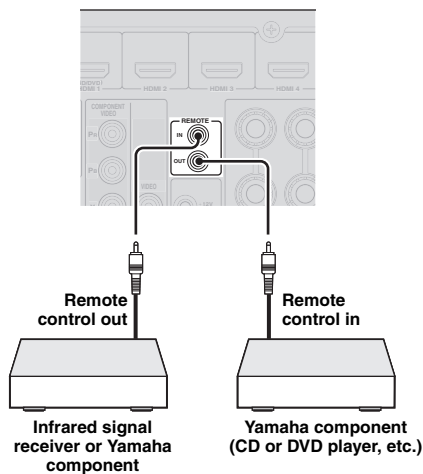

## Connecting a Yamaha iPod universal dock or Bluetooth™ wireless audio receiver

This unit has the DOCK jack, to which you can connect a Yamaha iPod universal dock (YDS-11, sold separately) or a Bluetooth wireless audio receiver (YBA-10, sold separately). You can play an iPod or a Bluetooth component with this unit by connecting it to the DOCK jack.

Use a dedicated cable for connection between the dock/receiver and this unit.

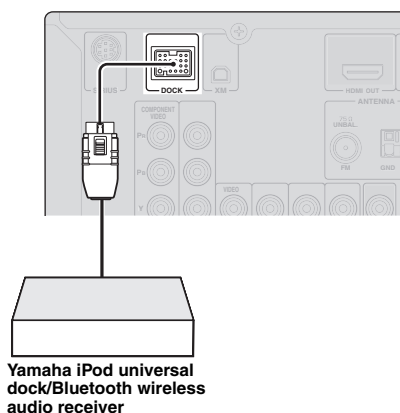

## Using the VIDEO AUX jacks on the front panel

Use the VIDEO AUX jacks on the front panel to connect a game console or a video camera to this unit. Be sure to turn down the volume of this unit and other components before making connections.

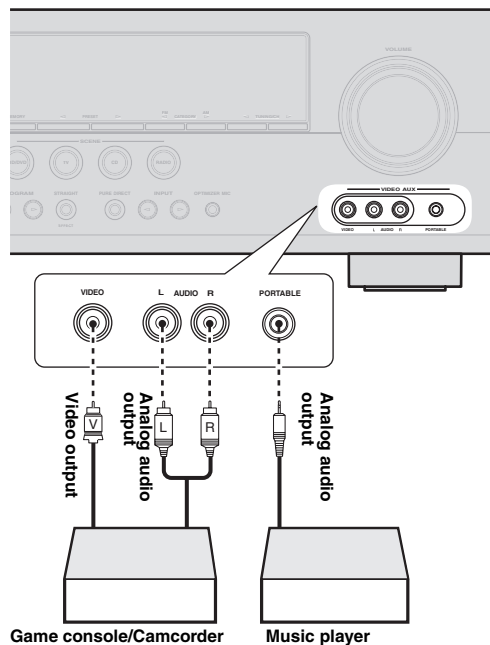

### Note

- When external components are connected both the PORTABLE jack and AUDIO jack, sound input from the PORTABLE jack is output.

## Connecting the FM and AM antennas

An indoor FM antenna and an AM loop antenna are supplied with this unit. Connect these antennas properly to the respective jacks.

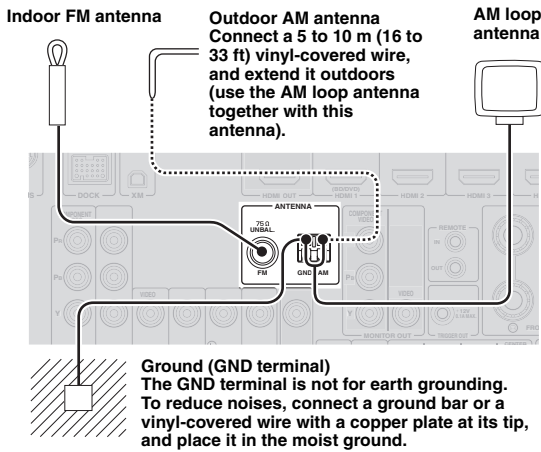

- The supplied antennas are normally sensitive enough to obtain good reception.
- Position the AM loop antenna away from this unit.
- If you cannot get good reception, we recommend that you use an outdoor antenna. For more details, consult the nearest authorized Yamaha dealer or service center.
- Always use the AM loop antenna even when the outdoor antenna is connected.

### Assembling the AM loop antenna

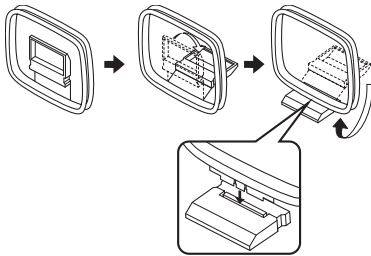

### Connecting the AM loop antenna

The wires of the AM loop antenna have no polarity. You can connect either wire to the AM terminal and the other to the GND terminal.

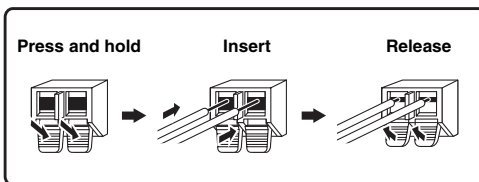

## Connecting the power cable

After all connections are complete, plug the AC power cable of this unit into an AC wall outlet.

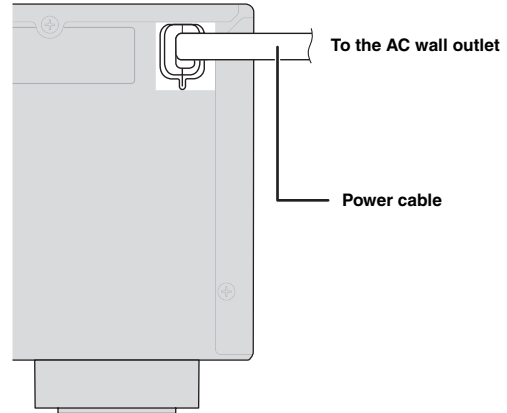

## Turning this unit on and off

- 1 Press **Ⓐ MAIN ZONE ON/OFF** on the front panel (or **Ⓩ POWER** on the remote control) to turn on this unit.
- 2 Press **Ⓐ MAIN ZONE ON/OFF** (or **Ⓩ POWER**) again to turn off this unit (standby mode).



- The unit needs a few seconds until ready to play back.
- You can also turn on this unit by pressing **Ⓜ SCENE** (or **Ⓜ SCENE**).
- This unit consumes a small amount of electricity even in the standby mode. We recommend disconnecting the power cable from the AC wall outlet.

### Caution

Do not unplug this unit while it is turned on. Doing so may damage this unit or cause the settings of this unit to be saved incorrectly.

# Optimizing the speaker setting for your listening room (YPAO)

This unit has a Yamaha Parametric Acoustic Optimizer (YPAO). With the YPAO, this unit automatically adjusts the output characteristics of your speakers based on speaker position, speaker performance, and the acoustic characteristics of the room. We recommend that you first adjust the output characteristics with the YPAO when you use this unit.

## Caution

- Be advised that it is normal for loud test tones to be output during the “Auto Setup” procedure. Do not allow small children to enter the room during the procedure.
- To achieve the best results, make sure the room is as quiet as possible while the “Auto Setup” procedure is in progress. If there is too much ambient noise, the results may not be satisfactory.



- See page 51 for the “Manual Setup” procedure.

“MIC ON. View OSD MENU” appears on the front panel display.

The following menu screen appears on the video monitor.

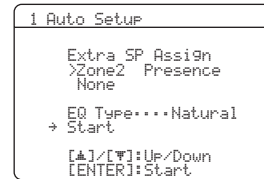

- You can bring up the above menu screen from the setup menu (see page 51).

## Using Auto Setup

### 1 Check the following points.

Before starting the automatic setup, check the following.

- All speakers and subwoofer are connected properly.
- Headphones are disconnected from this unit.
- The video monitor is connected properly.
- This unit and the video monitor are turned on.
- This unit is selected as the video input source of the video monitor.
- The connected subwoofer is turned on and the volume level is set to about half way (or slightly less).
- The crossover frequency controls of the connected subwoofer are set to the maximum.

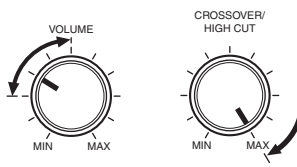

Subwoofer

### 3 Place the optimizer microphone at your normal listening position on a flat level surface with the omni-directional microphone heading upward.

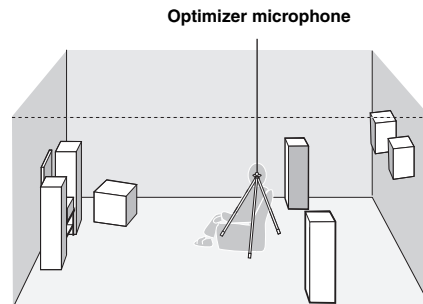

- It is recommended that you use a tripod or something similar to fix the optimizer microphone at the same height as your ears would be when seated in your listening position. You can fix the optimizer microphone to the tripod with the attaching screw of the tripod.

### 2 Connect the supplied optimizer microphone to the OPTIMIZER MIC jack on the front panel.

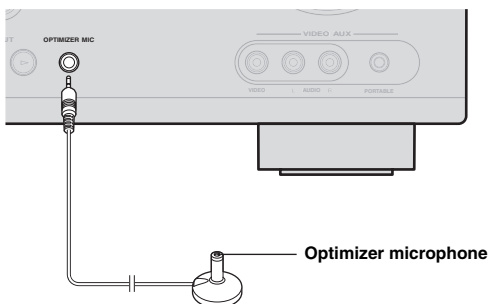

### 4 When the speakers are connected to EXTRA SP terminals, press **[15]Cursor** **▲** repeatedly to select “Extra SP Assign,” and then press **[15]Cursor** **</>** to select how to use EXTRA SP terminals from “Zone2,” “Presence” or “None.”

If this unit does not work when you press **[15]Cursor**, press **[13]SETUP** once and then operate this unit.

**5 To select a sound character for adjustment, press [F5]Cursor ▾ to select “EQ Type” and then press [F5]Cursor </>.**

If this unit does not work when you press [F5]Cursor, press [F3]SETUP once and then operate this unit. This unit has a parametric equalizer that adjusts the output levels for each frequency range. The equalizer is adjusted to produce a cohesive sound field based on automatically measured speaker characteristics. In “EQ Type,” you can select the following parametric equalizer characteristics suitable for the desired sound characteristics.

**Natural**

This adjusts all speakers to achieve natural sound. Select this if sounds in the high frequency range seem too strong when “EQ Type” is set to “Flat.”

**Flat**

This adjusts each speaker to obtain the same characteristics. Select this if your speakers have similar qualities.

**Front**

This adjusts each speaker to obtain the same characteristics as the front left and right speakers. Select this if your front left and right speakers have significantly better qualities than the other speakers.

**6 Press [F5]Cursor ▾ to select “Start” and then press [F5]ENTER to start the setup procedure.**

A countdown starts and a measurement starts in 10 seconds. A loud test tone is output during measurement.

**Notes**

- During the automatic setup procedure, do not perform any operation on this unit.
- Press [F5]Cursor ▲ to cancel the automatic setup procedure.

Measurement takes about 3 minutes. To obtain precise results, stay where you will not disturb the measurement, such as to the side of or behind the speakers or outside the room.

When measurement is successfully completed, “YPAO Complete” appears on the front panel display and the results appear on the monitor.

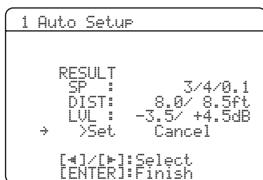

**SP**

Displays the number of speakers connected to this unit in the following order:  
Total of Front and Center/Total of Surround and Surround Back/Subwoofer

**DIST**

Displays the speaker distance from the listening position in the following order:

Closest speaker distance/Farthest speaker distance

**LVL**

Displays the speaker output levels in the following order:

Lowest speaker output level/Highest speaker output level

**Notes**

- If “ERROR” appears on the video monitor during “Auto Setup,” measurement is canceled and the type of error is displayed. For details, see “When an error message is displayed during measurement” (page 21).
- If problems occur during measurement, “WARNING (XX)” (xx indicates the number of warning) appears above “RESULT” (see page 21).

**7 Press [F5]ENTER to confirm the settings.**

The speaker characteristics are adjusted according to measurement results.

To cancel the operation, press [F5]Cursor </> to select “Cancel” and press [F5]ENTER.

When the following screen appears, remove the optimizer microphone. “Auto Setup” is now complete.



The optimizer microphone is sensitive to heat. Store it in a cool place and away from direct sunlight after measurement. Do not leave it in a place where it will be subjected to high temperatures such as on an AV component.

**☀**

- If you do not want to apply the measurement results, select “Cancel.”
- Perform “Auto Setup” again if you change the number or positions of speakers.
- If you press [F5]ENTER before removing the optimizer microphone, “1 Auto Setup” of “Speaker Setup” in the setup menu (see page 51) is displayed.



## When an error message is displayed during measurement

Select “Retry” or “Exit” using **[F5]Cursor** </> and then press **[F5]ENTER**.

```

ERROR
→ E-9:USER CANCEL
   Don't operate
   any function

>Retry  Exit
[←]/[→]:Select
[ENTER]:Return
  
```

### Retry

Performs “Auto Setup” again.

### Exit

Terminates the measurement and “Auto Setup.”



- See page 69 for details on error messages.
- When “E-5:NOISY” appears, you can continue measurement. To continue measurement, select “Proceed.” However, we recommend that you solve the problem first and then perform measurement again.

## When a warning message is displayed after measurement

If a problem occurs during measurement, “WARNING” is displayed on the result display screen. Check the error and solve the problems.

```

WARNING

W-1:OUT OF PHASE
Reverse channel
FL  ---
CENTER ---
SL  ---
SBL ---

[←]/[→]:Select
[ENTER]:Return
  
```



- See page 70 for details on warning messages.
- Optimization will not be performed while a warning message is displayed. We recommend that you solve the problem and perform “Auto Setup” again.

### 1 Check if “→” is displayed on the left of “WARNING” and press **[F5]ENTER**.

Details of the warning message are displayed. If there are multiple warning messages, you can display the next message using **[F5]Cursor** >.

### 2 To return to the top result display, press **[F5]ENTER** again.

# BASIC OPERATION

## Playback

### Basic procedure

- 1 Turn on external components (TV, DVD player, etc.) connected to this unit.
- 2 Press **◀/▶** INPUT (or **8** Input selection keys) to select an input source. The name of the selected input source is displayed for a few seconds.

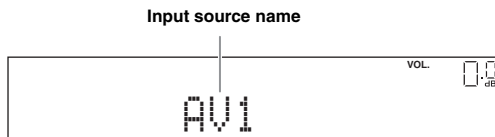

- You can change the input source name displayed on the front panel display or the OSD on the video monitor as necessary (see page 55).

- 3 Play the external component that you have selected as the source input, or select a radio station on the tuner.

Refer to the operating instructions of the external component for details on playback. For selecting radio stations or playback of an iPod or Bluetooth component using this unit, see the following.

- FM/AM radio tuning (see page 29)
- Bluetooth component playback (see page 42)
- iPod playback (see page 40)

- 4 Turn the **◂** VOLUME control to adjust the volume (or press **16** VOLUME +/-).

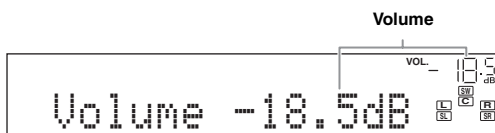

#### Note

When you play back a DTS-CD, noise may be output in some conditions, which may cause a speaker malfunction. Make sure that the volume is set to low before starting playback. If noise is output, do the following.

- 1) When only noise is output  
If a DTS bitstream signal is not properly input to this unit, only noise is output. Connect the playback component to this unit by digital connection and play back the DTS-CD. If the condition is not improved, the problem may result from the playback component. Consult the manufacturer of the playback component.
- 2) When noise is output during playback or skip operation  
Before playing back the DTS-CD, display the option menu after selecting the input source and set "Decoder Mode" to "DTS" (see page 44).

### Using the SCENE function

This unit has a SCENE function that allows you to change input sources and sound field programs with one key. Four scenes are available for different usages, such as playing movies or music. The following input sources and sound field programs are provided as the initial factory settings.

	Input source	Sound field program
BD/DVD	HDMI 1	Straight
TV	AV 1	Straight
CD	AV 3	Straight
RADIO	TUNER	7ch Enhancer



- When this unit is on standby, you can turn on this unit by pressing the SCENE key.
- When connecting a Yamaha DVD/CD player that has the REMOTE OUT jack of this unit, you can play back a DVD/CD on the player by selecting BD/DVD or CD SCENE function.

### Selecting a SCENE

Press **◂** SCENE (or **12** SCENE).

### Registering input source/sound field program

Select the desired input source/sound field program, and press down **◂** SCENE (or **12** SCENE) until "SET Complete" appears on the front panel display.

While display in the OPTION menu or SETUP menu, "SCENE Setting Complete" appears on the video monitor (OSD).

### Switching remotely controlled external components linked to scene selections

You can operate an external component with the remote control of this unit by setting a remote control code for the external component for each input source. Setting remote control codes for desired input sources allows you to switch between external components linked to scene selections.

- 1 Register the remote control code of an external component to the desired input source (see page 59).

#### Note

- Remote control codes cannot be registered to TUNER, SIRIUS, or XM input sources.

- 2** Press **[8]** **Input selection keys** on the remote control for the input source whose remote control code was registered in step 1 for about 3 seconds while pressing down **[12]** **SCENE** key whose assignment you want to change. The external component can now be controlled remotely just by selecting a scene.

From now on the external component can be remotely controllable just by selecting a scene.

### Muting audio output temporarily (MUTE)

- 1** Press **[18]** **MUTE** on the remote control to mute the audio output.

The MUTE indicator on the front panel display flashes while audio output is muted.

- 2** Press **[18]** **MUTE** again to resume audio output.

### Adjusting high/low frequency sound (tone control)

You can adjust the balance of the high frequency range (Treble) and low frequency range (Bass) of sounds output from the front left and right speakers to obtain desired tone.

- 1** Press **[K]** **TONE CONTROL** on the front panel repeatedly to select “Treble” or “Bass.”

The current setting is displayed on the front panel display.

Treble 0.0dB

- 2** Adjust the frequency range using

**[L]** **PROGRAM** **</>**.

Control range: -10.0 dB to +10.0 dB

The display returns the previous screen soon after you release the key.

#### Notes

- The tone control settings are not effective during playback in Pure Direct mode.
- If you set the balance extremely off, sounds may not match those from other channels well.

### Enjoying pure hi-fi sound

Use Pure Direct mode to enjoy the pure high fidelity sound of the selected source. When Pure Direct mode is activated, this unit plays back the selected source with the least circuitry.

Press **[N]** **PURE DIRECT** (or **[11]** **PURE DIRECT**) to turn the Pure Direct mode on or off.

**[N]** **PURE DIRECT** lights up when you set Pure Direct mode on.

The front panel display turns off while the Pure Direct mode is on. It turns on temporarily when you control this unit (such as volume control). The front panel display turns on again once you set the Pure Direct mode to off.

The following features are disabled in Pure Direct mode.

- sound field program, tone control
- display and operation of the option menu and setup menu
- multizone function

### Using your headphones

Plug your headphones in the **[B]** **PHONES** jack on the front panel.

When you select a sound field program while using the headphones, the mode is automatically set to SILENT CINEMA mode.

#### Notes

- When you connect headphones, no signals are output at the speaker terminals.
- When multi-channel signals are processed, sounds in all channels are divided to left and right channels. When the input source is set to “MULTI CH,” only front L/R sound is output from the headphones.

## Displaying input signal information

When HDMI1-4 or AV1-4 is selected as the input source, you can display audio/video signal information.



- Input signal information is displayed on both a video monitor and the front panel display.
- Information on the input signal is also displayed on the front panel display. You can select the desired item using **[5]Cursor**  $\Delta$  /  $\nabla$ .

### 1 Select the desired input source, and press **[4]OPTION**.

The option menu for the selected input source is displayed (see page 43).

### 2 Press **[5]Cursor** $\Delta$ / $\nabla$ to select “Signal Info,” and press **[5]ENTER**.

Information on input signals is displayed. See page 44 on messages displayed on the screen.

#### Note

- If an HDMI related error occurs, error information is displayed at the bottom of the screen.
- Information on the input signal is also displayed on the front panel display. You can select the desired item using **[5]Cursor**  $\Delta$  /  $\nabla$ .

### 3 To end the information display, press **[4]OPTION**.

## Changing information on the front panel display

Information displayed on the front panel display can be changed by pressing **[E]INFO** (or **[10]INFO**). The following information can be displayed according to the input source. For example, if you select HDMI1 input and display “DSP Program,” the following screen appears on the front panel display.

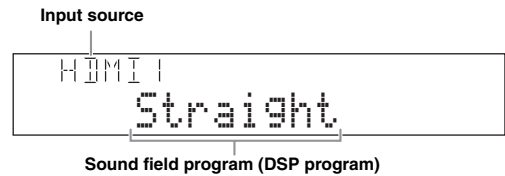

HDMI1-4:	Input, DSP Program, Audio Decoder
AV1-6:	Input, DSP Program, Audio Decoder
AUDIO1-2:	Input, DSP Program, Audio Decoder
MULTI CH:	Input
V-AUX:	Input, DSP Program, Audio Decoder
FM/AM:	Frequency, DSP Program, Audio Decoder
XM:	Channel, Category, Song, Antenna, DSP Program, Audio Decoder
SIRIUS:	Channel, Category, Artist / Song, Composer, Antenna, DSP Program, Audio Decoder
iPod (Simple remote mode):	Input, DSP Program, Audio Decoder
iPod (Menu browse mode):	(in PlayInfo displayed) Artist, Album, Song, DSP Program, Audio Decoder (in Play menu displayed) List
Bluetooth:	Input, DSP Program, Audio Decoder

## Using the sleep timer

The sleep timer is useful if you want to go to sleep while this unit is playing or recording a source.

Press **[6]SLEEP** repeatedly to set the amount of time.

Each time you press **[6]SLEEP**, the front panel display changes as shown below.

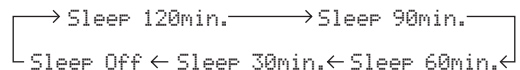

When the sleep timer is set, the SLEEP indicator on the front panel display lights up.

Press **[6]SLEEP** on the remote control repeatedly until “Sleep Off” appears on the front panel display.

# Enjoy the sound field programs

This unit is also equipped with a Yamaha digital sound field processing (DSP) chip. You can enjoy multi-channel sounds for almost all input sources using various sound field programs stored on the chip and a variety of surround decoders.

## Selecting sound field programs

### ■ Selecting a sound field program on the front panel

Press **PROGRAM** </> repeatedly to select a desired sound field program.

### ■ Selecting a sound field program with the remote control

Perform the following operations depending on the category of the sound field programs.

- Sound field programs for movies/TV programs..... Press **MOVIE** repeatedly.
- Sound field programs for music ..... Press **MUSIC** repeatedly.
- Stereo reproduction ..... Press **STEREO** repeatedly.
- Multi-channel stereo reproduction ..... Press **STEREO** repeatedly.
- Compressed music enhancer ..... Press **STEREO** repeatedly.
- Surround decoder ..... Press **SUR.DECODE** repeatedly.

For example, if you select “Sci-Fi” in “movie/TV program,” the following screen appears on the front panel display.

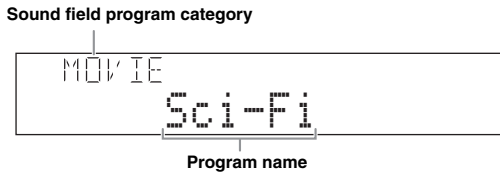

### Notes

- Sound field programs are stored for each input source. When you change the input source, the sound field program previously selected for that input source is applied again.
- When you play back the Dolby Digital Plus, Dolby TrueHD, DTS Express, DTS-HD Master Audio, or DTS-HD High Resolution Audio sources, this unit does not apply any sound field program other than the surround decoder and they are played back in straight decode mode.
- If the sampling frequency of an input source is higher than 96 kHz, this unit does not apply any sound field programs.

## Sound field program descriptions

This unit provides sound field programs for multiple categories including music, movies and stereo reproduction. Select a sound field program based on your listening preference, not merely on the name of the program, etc.



- You can check what speakers are currently outputting signals with the speaker indicators on the front panel display (see page 6).
- Each program can adjust sound field elements (sound field parameters). For details, see page 46.
- **CINEMA DSP** in the table indicates the sound field program with CINEMA DSP.

## For movie/TV program sources **CINEMA DSP**

Program	Descriptions
<b>Standard</b>	This program creates a sound field emphasizing the surrounding feeling without disturbing the original acoustic positioning of multi-channel audio such as Dolby Digital and DTS. It has been designed with the concept of “an ideal movie theater,” in which the audience is surrounded by beautiful reverberations from the left, right and rear.
<b>Spectacle</b>	This program represents the spectacular feeling of large-scale movie productions. It reproduces a broad theater sound field matching the cinemascope and wider-screen movies with an excellent dynamic range from very small to extremely large sound.
<b>Sci-Fi</b>	This program clearly reproduces the finely elaborated sound design of the latest science fiction and special effects-featuring movies. You can enjoy a variety of cinematographically created virtual spaces reproduced with clear separation between dialog, sound effects and background music.
<b>Adventure</b>	This program is ideal for precisely reproducing the sound design of action and adventure movies. The sound field restrains reverberations but puts emphasis on reproducing a powerful space expanded widely to the left and right. The reproduced depth is also restrained relatively to ensure the separation between audio channels and the clarity of the sound.

Program	Descriptions
<b>Drama</b>	This sound field features stable reverberations that match a wide range of movie genres from serious dramas to musicals and comedies. The reverberations are modest but offer an optimum 3D feeling, reproducing effects tones and background music softly but cubically around clear words and center positioning in a way that does not fatigue the listener even after long hours of viewing.
<b>Mono Movie</b>	This program is provided for reproducing monaural video sources such as a classic movie in an atmosphere of a good old movie theater. The program produces the optimum expansion and reverberation to the original audio to create a comfortable space with a certain sound depth.
<b>Sports</b>	This program allows the listeners to enjoy stereo sport broadcasts and studio variety programs with enriched live feeling. In sports broadcasts, the voices of the commentator and sportscaster are positioned clearly at the center while the atmosphere of the stadium expands in an optimum space to offer the listeners with a feeling of presence in the stadium.
<b>Action Game</b>	This sound field has been suitable for action games such as car racing and FPS games. It uses the reflection data that limits the effects range per channel in order to offer a powerful playing environment with a being-there feeling by enhancing various effects tones while maintaining a clear sense of directions.
<b>Roleplaying Game</b>	This sound field has been suitable for role-playing and adventure games. It combines the sound field effects for movies and the sound field designs for “Action Game” to represent the depth and 3D feeling of the field during play, while offering movie-like surround effects in the movie scenes in the game.

**For audio music sources**



Program	Descriptions
<b>Hall in Munich</b>	This sound field simulates a concert hall with approximately 2500 seats in Munich, using stylish wood for the interior finishing as normal standards for European concert halls. Fine, beautiful reverberations spread richly, creating a calming atmosphere. The listener’s virtual seat is at the center left of the arena.
<b>Hall in Vienna</b>	This is an approximately 1700-seated, middle-sized concert hall with a shoebox shape that is traditional in Vienna. Pillars and ornate carvings create extremely complex reflections from all around the audience, producing a very full, rich sound.
<b>Chamber</b>	This program creates a relatively wide space with a high ceiling like an audience hall in a palace. It offers pleasant reverberations that are suitable for courtly music and chamber music.
<b>Cellar Club</b>	This program simulates a live house with a low ceiling and homey atmosphere. A realistic, live sound field features powerful sound as if the listener is in a row in front of a small stage.
<b>The Roxy Theatre</b>	This is the sound field of a rock music live house in Los Angeles, with approximately 460 seats. The listener’s virtual seat is at the center left of the hall.
<b>The Bottom Line</b>	This is the sound field at stage front in The Bottom Line, that was a famous New York jazz club once. The floor can seat 300 people to the left and right in a sound field offering real and vibrant sound.
<b>Music Video</b>	This sound field offers an image of a concert hall for live performance of pop, rock and jazz music. The listener can indulge oneself in a hot live space thanks to the presence sound field that emphasizes the vividness of vocals and solo play and the beat of rhythm instruments, and to the surround sound field that reproduces the space of a big live hall.

**For stereo reproduction**

Program	Descriptions
<b>2ch Stereo</b>	Use this program to mix down multi-channel sources to 2 channels.



- When multi-channel signals (Dolby Digital and DTS) are input, they are downmixed to 2 channels and output from the front left and right speakers.

## For Multi-channel stereo reproduction



Program	Descriptions
<b>7ch Stereo</b>	Use this program to output sound from all speakers. When you play back multi-channel sources, this unit downmixes the source to 2 channels, and then outputs the sound from all speakers. This program creates a larger sound field and is ideal for background music at parties, etc.

## The Compressed Music Enhancer

Program	Descriptions
<b>Straight Enhancer</b>	Use this program to enhance the sound nearest to the original depth and width of the 2-channel or multi-channel compression artifacts.
<b>7ch Enhancer</b>	Use this program to play back compression artifacts in 7-channel stereo.

## Surround decode mode

Select this program to playback sources with selected decoders. You can playback 2-channel sources on multi-channels. See page 45 for details.

Decoder	Descriptions
<b>Pro Logic</b>	Dolby Pro Logic decoder suitable for all kinds of sources.
<b>PLIIX Movie / PLII Movie</b>	Dolby Pro Logic IIX (or Dolby Pro Logic II) decoder suitable for movies. If your listening environment is as follows, you cannot select the Dolby Pro Logic IIX decoder. <ul style="list-style-type: none"> <li>• When the surround back speakers are not connected</li> <li>• When headphones are connected</li> </ul>
<b>PLIIX Music / PLII Music</b>	Dolby Pro Logic IIX (or Dolby Pro Logic II) decoder suitable for music. If your listening environment is as follows, you cannot select the Dolby Pro Logic IIX decoder. <ul style="list-style-type: none"> <li>• When the surround back speakers are not connected</li> <li>• When headphones are connected</li> </ul>
<b>PLIIX Game / PLII Game</b>	Dolby Pro Logic IIX (or Dolby Pro Logic II) decoder suitable for games. If your listening environment is as follows, you cannot select the Dolby Pro Logic IIX decoder. <ul style="list-style-type: none"> <li>• When the surround back speakers are not connected</li> <li>• When headphones are connected</li> </ul>
<b>Neo:6 Cinema</b>	DTS decoder suitable for movies.
<b>Neo:6 Music</b>	DTS decoder suitable for music.
<b>Neural Sur. (U.S.A. model only)</b>	Neural Surround processing for any sources. The Neural Surround decoder is compatible with PCM signals and analog 2-channel input sources. When Neural Surround-incompatible signals are being input while the Neural Surround decoder is selected, multi-channel sources are decoded straight into the appropriate channels without any additional effect processing and the Neural Surround-incompatible PCM signals are reproduced in stereo. The Neural Surround decoder is especially suitable for the XM HD Surround program of XM Satellite Radio.



- An input source is played back in straight decode mode (see page 28) when multi-channel audio signal is input.

## Enjoying unprocessed input sources (Straight decoding mode)

In straight decoding mode, sounds are reproduced without sound field effect. 2-channel stereo sources are output from only the front left and right speakers. Multi-channel input sources are decoded straight into the appropriate channels and multi-channel sounds are reproduced without a sound field effect.

### 1 To enable straight decoding mode, press

**M** **STRAIGHT** (or **II** **STRAIGHT**).

“Straight” appears on the front panel display.

### 2 To cancel straight decoding mode, press

**M** **STRAIGHT** (or **II** **STRAIGHT**) again.

A sound field program name appears on the front panel display, and sound is reproduced with that sound field effect.

## Enjoying sound field programs without surround speakers (Virtual CINEMA DSP)

Virtual CINEMA DSP allows you to enjoy DSP sound field surround effects even without any surround speakers by using virtual surround speakers. You can even enjoy Virtual CINEMA DSP using a minimal two-speaker system that does not include a center speaker.

When “Sur. L/R SP” in the setup menu is set to “None” (see page 52), this unit operates in Virtual CINEMA DSP mode.

### Note

- Virtual CINEMA DSP is not available in the following conditions even if you set “Sur. L/R SP” to “None” (see page 52).
  - headphone plug is connected to the PHONES jack.
  - 7ch Stereo of the field sound program is selected.
  - Pure Direct mode or straight decoding mode is used.

## Enjoy sound field programs with headphones (SILENT CINEMA™)

SILENT CINEMA allows you to enjoy multi-channel sources with your headphones. SILENT CINEMA mode is automatically selected when you connect the headphone plug to the PHONES jack.

### Note

- SILENT CINEMA mode is not available in the following conditions.
  - 2ch Stereo of the sound field program is selected.
  - Pure Direct mode or straight decoding mode is selected.

## Using CINEMA DSP 3D mode

CINEMA DSP 3D mode creates the intensive and accurate stereoscopic sound field in the listening room. To use this unit in CINEMA DSP 3D mode, presence speakers are required. Connect the presence speakers to the EXTRA SP jacks, perform the following settings and select a CINEMA DSP related sound field program.

- Set the “Extra SP Assign” to “Presence” (see page 51).
- Enables the CINEMA DSP 3D in the setup menu (see page 47).
- Disconnect the headphones from the PHONES jack.

When the sound field program runs in CINEMA DSP 3D mode, the 3D indicator on the front panel lights up.



# FM/AM tuning

The FM/AM tuner of this unit provides the following two modes for tuning.

## ■ Frequency tuning mode (Auto tuning/Manual tuning)

You can tune in to a desired FM/AM station by searching or specifying its frequency.

## ■ Preset tuning mode (Preset tuning)

You can preset the frequencies of FM/AM stations by registering them to specific numbers, and later just select those numbers to tune in.

### Note

- Adjust the FM/AM antennas connected to this unit for the best reception.

## Tuning in to the desired FM/AM station (Frequency tuning)

- 1 Press **INPUT**  $\triangleleft/\triangleright$  (or **TUNER**) repeatedly and switch the input source to "TUNER."
- 2 Press **FM** (**FM**) or **AM** (**AM**) to select a band.  
"FM" or "AM" appears on the front panel display according to the band that you have selected.
- 3 Press **TUNING/CH**  $\triangleleft/\triangleright$  (or **TUN./CH**  $\triangle/\nabla$ ) to specify the frequency.  
To adjust the frequency to a higher range, press  $\triangleright$  (or  $\triangle$ ). To adjust it to the lower range, press  $\triangleleft$  (or  $\nabla$ ). The TUNED indicator on the front panel display lights up when the tuner is tuned in to a station. The STEREO indicator also lights up if the program being broadcasted is in stereo.



The frequency changes in the following manner according to how you press **TUNING/CH**  $\triangleleft/\triangleright$  (or **TUN./CH**  $\triangle/\nabla$ ).

### When you press the key more than 1 second

The tuner searches the frequency of a station that is detectable around the current frequency. This is effective when the tuner can receive strong signals without any interference. Once the search starts, release the key. When you keep holding the key, the search continues even when a station is detected. This is useful when you want to tune in to a specific station.

### When you press and release the key

The tuner increases or decreases the frequency in steps. Use this method when the tuner cannot receive strong signals and stations are skipped during the search. You can listen to better quality sound even when the tuner cannot receive a strong signal.



- You can switch between stereo and monaural for FM broadcast in the option menu (see page 44).

## 4 To tune in by direct frequency tuning, enter the frequency of the desired station using the numeric keys on the remote control.

Enter only integers. For example, if you want to set the frequency to 88.9 MHz, enter "889" using **Numeric keys**.

### Note

- "Wrong Station!" appears on the front panel display when you enter a frequency that is out of receivable range. Make sure that the entered frequency is correct.

## Registering FM/AM stations and tuning in (Preset tuning)

You can register up to 40 FM/AM stations (Preset) using "Automatic station preset" or "Manual station preset."

### Registering stations by automatic station preset

The tuner automatically detects FM stations with strong signals and registers up to 40 stations. AM stations cannot be automatically registered. Use manual station preset.

- 1 Press **INPUT**  $\triangleleft/\triangleright$  repeatedly (or press **TUNER**) to switch the input source to "TUNER."
- 2 Press **OPTION** on the remote control.  
The option menu screen for setting options of tuner input appears on the front panel display.  

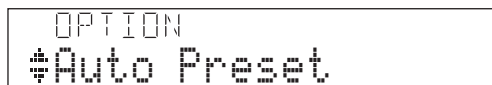
  - For details on the option menu, see page 43.
  - The option menu is displayed on monitor components.
- 3 Select "Auto Preset," and press **ENTER**.



Automatic station preset starts about 5 seconds later from the lowest frequency upwards.

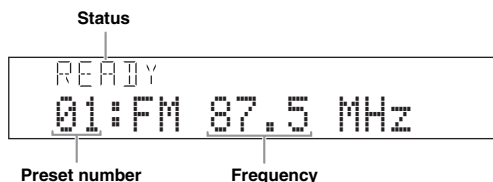

- You can select the preset number at which the preset starts by pressing **PRESET**  $\triangle/\nabla$  or **Cursor**  $\triangle/\nabla$  while the front panel display is in the state as shown in the below figure.
- To cancel registration, press **RETURN** on the remote control.



During the automatic station preset, the upper area of the screen changes as follows: READY → SEARCH → MEMORY each time a station is registered.

When registration is complete, “FINISH” appears and the option menu screen automatically reappears.

When you press **[14]OPTION** on the remote control, the screen returns to the original state.

### Registering stations by manual station preset

You can manually register AM stations or FM stations with weak signals.

**1 Tune in to a station referring to “Tuning in to the desired FM/AM station (Frequency tuning)” (see page 29).**

**2 Press **[F]MEMORY** (or **[9]MEMORY**).**  
“Manual Preset” appears on the front panel display, followed soon by the preset number to which the station will be registered.



- By pressing down **[F]MEMORY** (or **[9]MEMORY**) for more than 2 seconds, you can skip step 3 and register the preset number to be one higher than the last preset number.

**3 Press **[G]PRESET** </> (or **[9]PRESET** Δ / ▽) on the remote control to select the preset number to which the station will be registered.**

When you select a preset number to which no station is registered, “Empty” appears on the display. When you select a registered preset number, a registered frequency is displayed on the right of the preset number.

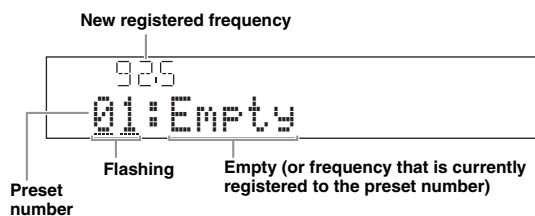

- You can select a preset number using the **[20]Numeric keys**.

**4 Press **[F]MEMORY** (or **[9]MEMORY**) again to register.**

When registration is complete, the screen returns to the original state.

To end the operation, press **[14]OPTION**.



- To cancel registration, press **[15]RETURN** on the remote control or leave the tuner without any operations for about 30 seconds.

### Calling a preset station (Preset tuning)

You can call preset stations registered by automatic station preset or manual station preset.

**Press **[G]PRESET** </> (or **[9]PRESET** Δ / ▽) to select a preset number.**



- Preset numbers to which no stations are registered will be skipped.
- When “No Presets” or “No Presets in Memory” is displayed it means that no stations are registered. See page 29 and register stations.
- You can directly select a preset number by pressing a **[20]Numeric keys** while calling a preset station. “Empty” appears on the display if you enter a preset number to which no station is registered. “Wrong Num.” appears if you enter an invalid number.

### Clearing the preset station

**1 Press **[I]INPUT** </> repeatedly (or press **[8]TUNER**) to switch the input source to “TUNER.”**

**2 Press **[14]OPTION** on the remote control.**  
The option menu screen for setting options of tuner input appears on the front panel display.

**3 Display “Clear Preset” using the **[15]Cursor** Δ / ▽ and press **[15]ENTER**.**

The following screen appears on the display.

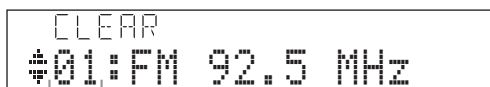

Preset number of the registered station you want to clear.



- You can cancel the operation and return to the option menu screen by pressing **[15]RETURN** on the remote control.

**4 Select the preset number of the registered station you want to clear using the **[15]Cursor** Δ / ▽ and press **[15]ENTER**.**

The preset station registered to the selected preset number is cleared. To clear the registration of multiple preset numbers, repeat the above steps. To end the operation, press **[14]OPTION**.

# XM® Satellite Radio tuning (U.S.A. model only)

## Listening to Satellite Radio

To listen to Satellite Radio, you'll need to connect either a SIRIUS or XM Satellite Radio tuner (sold separately) to your satellite-ready receiver. Satellite Radio is available to residents of the US (except Alaska and Hawaii).

Satellite Radio delivers a variety of commercial-free music from categories ranging from Pop, Rock, Country, R&B, Dance, Jazz, Classical and many more plus coverage of all the top professional and college sports including play by play games from select leagues and teams. Additional programming includes expert sports talk, uncensored entertainment, comedy, family programming, local traffic and weather and news from your most trusted sources.

Whether you purchase a SIRIUS or XM tuner, you'll need to activate and subscribe to begin enjoying the service. Easy to follow installation and setup instructions are provided with the satellite tuners. Whichever service you choose, there are a variety of programming packages available, including the option of adding "The Best of SIRIUS" programming to your XM tuner or "The Best of XM" programming to your SIRIUS tuner, enabling you to enjoy the most popular programming among both services. Family friendly packages are also available to restrict channels featuring content that may be inappropriate for children.

To subscribe to XM, U.S. customers should visit [xmradio.com](http://xmradio.com) or call 1-800-XMRADIO (1-800-967-2346).

To subscribe to SIRIUS, U.S. customers can call 1-888-539-SIRI (1-888-539-7474) or visit [sirius.com](http://sirius.com) (US).

### SIRIUS XM Radio Legal

SIRIUS, XM and all related marks and logos are trademarks of Sirius XM Radio Inc. and its subsidiaries. All other marks and logos are the property of their respective owners. All rights reserved. SIRIUS and XM subscriptions sold separately. Taxes and a one-time activation fee may apply. XM tuners and home docks or SIRIUS tuners (each sold separately) are required to receive the SIRIUS or XM satellite radio service. All programming and fees subject to change. It is prohibited to copy, decompile, disassemble, reverse engineer, hack, manipulate or otherwise make available any technology or software incorporated in receivers compatible with the SIRIUS or XM Satellite Radio Systems. **Service not available in Alaska and Hawaii.**

## Connecting XM Mini-Tuner Home Dock

Connect XM Mini-Tuner and XM Mini-Tuner Home Dock (sold separately) to the XM jack on the rear panel of this unit. For details, see the operating instructions provided with the XM Mini-Tuner Home Dock.

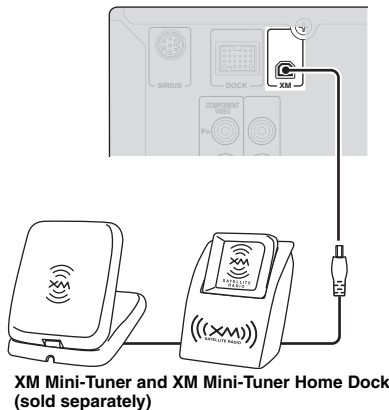

- To ensure optimal reception of the XM Satellite Radio signals, the XM Mini-Tuner Home Dock must be placed at or near a southerly facing window with no obstacles in the path to the sky. You can mount it indoors or outdoors. Use the "Antenna" information on the front panel display or on the OSD screen (see page 34) to check the antenna reception level and adjust the orientation of the antenna.

### Notes

- If "CHECK ANTENNA," "CHECK XM TUNER" or "NO SIGNAL" appears on the front panel display, the connection and setting of the antenna, XM Mini-Tuner Home Dock, or XM Mini-Tuner may not be correct.
- When "UPGRADE XM TUNER" is displayed, it means that the connected antenna is old. See page 65 for details.

## Activating XM Satellite Radio

Once you have installed the XM Mini-Tuner Home Dock, inserted the XM Mini-Tuner, connected the XM Mini-Tuner Home Dock to your XM Ready® home audio system, and installed the antenna, you are ready to subscribe and begin receiving XM programming. There are three places to find your eight character XM Radio ID: on the XM Mini-Tuner, on the XM Mini-Tuner package, and on XM Channel 0. Record the XM Radio ID in the following eight squares for reference.

□	□	□	□	□	□	□	□
---	---	---	---	---	---	---	---

### Note

- The XM Radio ID does not use the letters "I," "O," "S" or "F." Activate your XM Satellite Radio service in the U.S. online at <http://activate.xmradio.com/> or call 1-800-XM-RADIO (1-800-967-2346). You will need a major credit card. XM will send a signal from the satellites to activate the full channel lineup. Activation normally takes 10 to 15 minutes, but during peak busy periods you may need to keep your XM Ready home audio system on for up to an hour. When you can access the full lineup on your XM Ready home audio system you are done.

## XM Satellite Radio® operations

### 1 Press the **Ⓢ** INPUT </> (or press **Ⓢ** XM) to select “XM” as the input source.

The XM Satellite Radio information (such as channel number, channel name, category, artist name, or song title) for the currently selected channel appears on the front panel display and video monitor (see page 34).

#### Search mode



Channel number      Channel name



- When you select “XM” as the input source, this unit automatically recalls the previously selected channel.

#### Note

- If a status message or an error message appears on the front panel display or on the OSD, see “XM Satellite Radio” (see page 65).

### 2 Search for a channel by using one of the XM Satellite Radio search modes.

- To select a channel from the all channel list, see “All Channel Search mode” on this page.
- To select a channel by category, see “Category Search mode” on this page.
- To select the desired channel directly by entering the channel number, see “Direct number access mode” on this page.
- To select a channel from the preset channels, see “Calling a preset channel (Preset Search mode)” (page 33).



- You can display the XM Satellite Radio information on the front panel display or in the video monitor (see page 34).
- You can set the XM Satellite Radio preset channels (see page 33).

#### ■ All Channel Search mode

Press **Ⓢ** TUNING/CH </> (or **Ⓢ** TUN./CH  $\Delta$  /  $\nabla$ ) repeatedly to search for a channel within all channels.

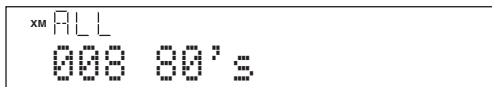

- You can search for a channel quickly by pressing and holding **Ⓢ** TUNING/CH </> (or **Ⓢ** TUN./CH  $\Delta$  /  $\nabla$ ).
- You can skip channels to the previous or next category by pressing **Ⓢ** CATEGORY </> (or **Ⓢ** CATEGORY </>).

#### ■ Category Search mode

### 1 Press **Ⓢ** CATEGORY </> (or **Ⓢ** CATEGORY </>) to select the channel category.

“CAT” is displayed on the front panel display during the channel category selection. When you select the category, the first channel in the category is selected.

Category search mode      The first channel in the category



Category name

#### Note

- If you don't operate within 10 seconds, the category search mode returns to “ALL (All Channel Search).”

### 2 While “CAT” is displayed on the front panel display, press **Ⓢ** TUNING/CH </> (or **Ⓢ** TUN./CH $\Delta$ / $\nabla$ ) repeatedly to search for a channel within the selected channel category.



- You can search for a channel quickly by pressing and holding **Ⓢ** TUNING/CH </> (or **Ⓢ** TUN./CH  $\Delta$  /  $\nabla$ ).

#### Note

- This unit skips the channels when this unit is in the All Channel Search mode or Category Search mode in the following cases (it is not malfunction of this unit):
  - the channel is out of service.
  - you do not subscribe to the channel.

#### ■ Direct number access mode

Press the **Ⓢ** Numeric keys to enter the desired three-digit channel number.

For example, to enter the number 123, press the **Ⓢ** Numeric keys as “1,” “2” and “3.”



- To display the Radio ID number displayed on the front panel display, select channel “0.”
- To enter a one-digit or two-digit channel number, press the **Ⓢ** Numeric keys on the remote control and then press **Ⓢ** ENT to confirm the input number.
- Instead of pressing **Ⓢ** ENT to tune into the channel immediately, you can wait a few seconds until this unit confirms the entered channel number.
- If no key is pressed within a few seconds after you enter a one-digit or two-digit number, this unit automatically confirms the entered channel number.
- If the selected channel is not available, an advisory message may appear. For details, see “XM satellite radio” on page 65.
- If you operate **Ⓢ** Numeric keys in preset search mode (see next page), a preset number is selected. If you want to directly select a channel number, press **Ⓢ** TUNING/CH </> (or **Ⓢ** TUN./CH  $\Delta$  /  $\nabla$ ) to switch to All Channel Search mode and enter the number.

## Registering XM Satellite Radio channels

You can use this feature to store up to 40 XM Satellite Radio channels. You can then recall any preset channel easily by selecting the preset channel as described in “Calling a preset channel (Preset Search mode)” on this page.

### Registering preset channels

#### 1 Search a channel you want to set as a preset channel in one of the XM Satellite Radio search modes.

For details, see “XM Satellite Radio operations” (see page 32).

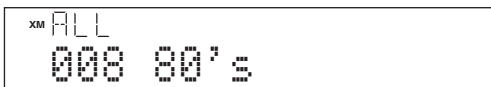

#### 2 Press **MEMORY** (or **MEMORY**).

The indicator on the front panel display changes as follows.

Currently registered channel number  
(or “----” if empty)



Channel number to be registered

Preset number to which new channel number is registered



- To store the selected channel under an empty preset number automatically, press and hold **MEMORY** (or **MEMORY**) for more than 2 seconds instead of step 2. In this case, the following steps are unnecessary.
- To cancel the preset operation, press **RETURN**.

#### 3 Press **PRESET** </> (or **PRESET** Δ / ▽) to select the stored preset station number.

##### Note

- You can also select a preset number by pressing the **Numeric keys**.

#### 4 Press **MEMORY** (or **MEMORY**).

## Calling a preset channel (Preset Search mode)

Prior to selecting a preset channel in the Preset Search mode, you must preset XM channels. For details, see “Registering preset channels” on this page.

Preset channel number



Press **PRESET** </> (or **PRESET** Δ / ▽) repeatedly to change the preset channel number (1 to 40).



- You can directly select a preset number by pressing a **Numeric keys** while calling a preset channel.

### Clearing preset channels

You can clear the assignments of preset XM Satellite Radio channels.

#### 1 Press **OPTION** on the remote control.

The option menu is displayed on the front panel display.

#### 2 Press **Cursor** ▽ repeatedly to select “Clear Preset” and then press **ENTER**.

#### 3 Press **Cursor** Δ / ▽ to select the preset station number that you want to clear.

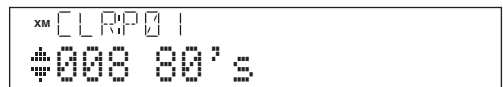

#### 4 Press **ENTER** to execute the clearing of the selected preset channel.

To clear the registration of multiple preset numbers, repeat the above steps. To end the operation, press **OPTION**.

## Displaying the XM Satellite Radio™ information

Use this feature to display the XM Satellite Radio information on the front panel display or on the OSD.

### Note

- If a status message or an error message appears on the front panel display or video monitor, see “XM Satellite Radio” (see page 65).

### ■ Front panel display

Press **Ⓢ** **INFO** (or **Ⓢ** **INFO**) repeatedly to toggle the following XM Satellite Radio information display modes.

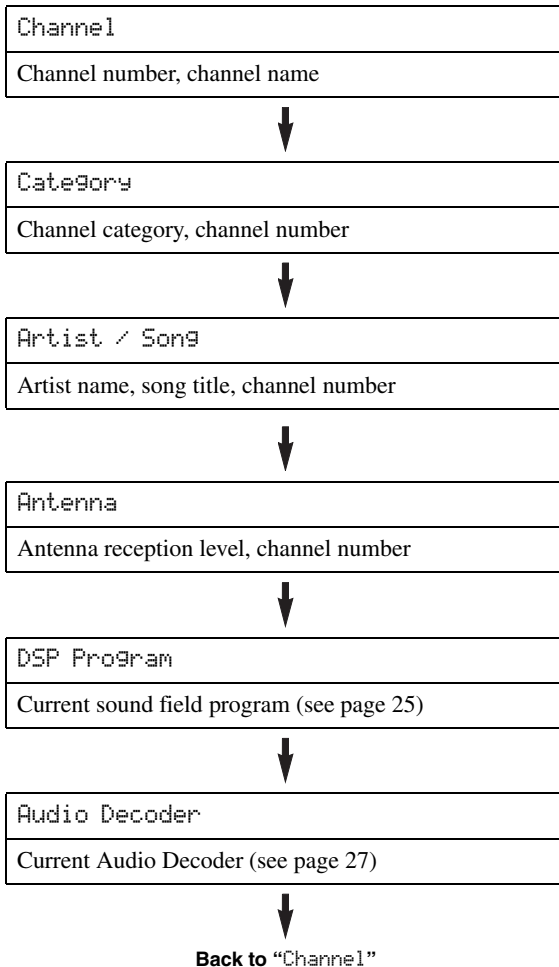

### Front Panel Display (example)



- If the XM Satellite Radio information contains a character that cannot be recognized by this unit, the character will be displayed with a space.
- When an information is unavailable, “—” appears.

### ■ Video monitor (OSD)

The following information is displayed on the OSD.

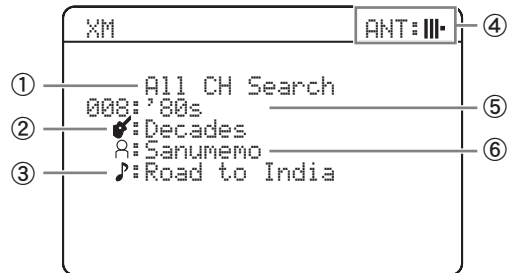

- ① Search mode (see page 32)
- ② Channel category
- ③ Song title
- ④ Antenna reception level
- ⑤ Channel number/name
- ⑥ Artist name



- To turn off the OSD, press **Ⓢ** **DISPLAY**.
- You can hold the music information screen or release it by **Ⓢ** **ENTER**.

# SIRIUS Satellite Radio™ tuning (U.S.A. model only)

## Connecting the SiriusConnect™ tuner

Connect the SiriusConnect tuner (sold separately) to the SIRIUS jack on the rear panel of this unit. For details, see the operating instructions provided with the SiriusConnect tuner.

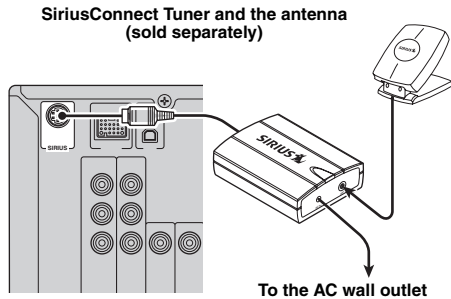

- To ensure optimal reception of the SIRIUS Satellite Radio signals, the antenna of the SiriusConnect tuner must be placed at or near a window with no obstacles in the path to the sky. The orientation of the antenna for the best reception differs depending on the area. Refer to the instruction manuals supplied with the SiriusConnect tuner for the installation of the antenna. You can mount it indoors or outdoors.
- Use the “Antenna” information in the front panel or “SIRIUS Information” screen in the video monitor (see page 39) to check the antenna reception level and adjust the orientation of the antenna.
- You need to connect the SiriusConnect tuner to the AC wall outlet.

### Notes

- If “CHECK SR TUNER” or “ANTENNA ERROR” appears on the front panel display, the connection of the SiriusConnect tuner or antenna is incorrect. In such cases, check the connection of the SiriusConnect tuner and the antenna.
- If “NOT SUPPORTED” appears on the front panel display, this unit does not support the connected SiriusConnect tuner.

## Activating SIRIUS Satellite Radio™ subscription

Before using the SIRIUS Satellite Radio feature, you need to activate your SIRIUS Satellite Radio subscription. To activate the subscription you need the Sirius ID which is uniquely assigned to the SiriusConnect tuner. Sirius ID is 12-digit number and it appears on the package of the SiriusConnect tuner, on the label of the SiriusConnect tuner, and when you tune into the SIRIUS Satellite Radio channel “0” (see below).

## Displaying the Sirius ID of your SiriusConnect tuner

- Press the **⊙INPUT**  $\triangleleft/\triangleright$  (or press **8[SIRIUS]**) to select “SIRIUS” as the input source.
- Press **200** and then **20ENT** to display the Sirius ID of your SiriusConnect tuner. “000 Sirius ID” and “xxxxxxxxxxxxx” (“xxxxxxxxxxxxx” indicates the 12-digit Sirius ID of your SiriusConnect tuner) appears alternately on the front panel display. Write the Sirius ID below.  
ID: \_\_\_\_\_

- Contact SIRIUS Satellite Radio to activate your subscription.

### SIRIUS Satellite Radio online information

Contact for activation

URL: <https://activate.siriusradio.com/>

Phone: 1-888-539-SIRIUS (1-888-539-7474)



- Status messages appear on the front panel display or OSD during the activation. For details, see “SIRIUS Satellite Radio” (see page 66). Once the activation is finished, “SUB UPDATED” appears.

## SIRIUS Satellite Radio™ operations

- Press the **⊙INPUT**  $\triangleleft/\triangleright$  (or press **8[SIRIUS]**) to select “SIRIUS” as the input source.

The cursor on the left of the SIRIUS indicator lights up on the front panel display and the SIRIUS Satellite Radio information (such as channel number, channel name, category, artist name, or song title) for the currently selected channel appears on the front panel display.

Search mode



Channel number      Channel name



- When you select “SIRIUS” as the input source, this unit automatically recalls the previously selected channel.

### Notes

- When you have not activated your subscription yet, you can only select “184” or “000.”
- If a status message or an error message appears on the front panel display or on the OSD, see “SIRIUS Satellite Radio” (see page 66).



## 2 Search for a channel by using one of the SIRIUS Satellite Radio search modes.

- To select a channel from the all channel list, see “All Channel Search mode” on this page.
- To select a channel by category, see “Category Search mode” on this page.
- To select the desired channel directly by entering the channel number, see “Direct number access mode” on this page.
- To select a channel from the preset channels, see “Calling a preset channel (Preset Search mode)” (page 37).



- You can display the SIRIUS Satellite Radio information on the front panel display or in the video monitor (see page 39).
- If you tune into a channel that you do not subscribe, “CALL SIRIUS on the front panel display” or “CALL 888-539-SIRIUS TO SUBSCRIBE on the OSD” appears.
- You can set the SIRIUS Satellite Radio preset channels (see page 37).

### ■ All Channel Search mode

Press **Ⓜ TUNING/CH** </> (or **Ⓜ TUN./CH** Δ / ▽) repeatedly to search for a channel within all channels.



- You can search for a channel quickly by pressing and holding **Ⓜ TUNING/CH** </> (or **Ⓜ TUN./CH** Δ / ▽).
- You can skip channels to the previous or next category by pressing **Ⓜ CATEGORY** </> (or **Ⓜ CATEGORY** </>).

### ■ Category Search mode

#### 1 Press **Ⓜ CATEGORY** </> (or **Ⓜ CATEGORY** </>) to select the channel category.

“CAT” is displayed on the front panel display during channel category selection. When you select the category, the first channel in the category is selected.

Category search mode    The first channel in the category

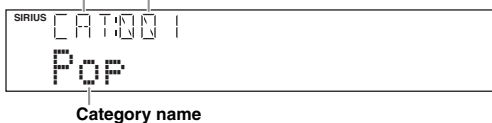

#### Note

- If you don't operate within 10 seconds, the category search mode returns to “ALL (All Channel Search).”

#### 2 While “CAT” is displayed on the front panel display, press **Ⓜ TUNING/CH** </> (or **Ⓜ TUN./CH** Δ / ▽) repeatedly to search for a channel within the selected channel category.



- You can search for a channel quickly by pressing and holding **Ⓜ TUNING/CH** </> (or **Ⓜ TUN./CH** Δ / ▽).

#### Note

- This unit skips the channels when this unit is in the All Channel Search mode or Category Search mode in the following cases (it is not malfunction of this unit):
  - the channel is locked (see page 38).
  - the channel is out of service.
  - you do not subscribe to the channel.

### ■ Direct number access mode

Press the **Ⓜ Numeric keys** to enter the desired three-digit channel number.

For example, to enter the number 123, press the **Ⓜ Numeric keys** as “1,” “2” and “3.”



- To display the Sirius ID number displayed on the front panel display, select channel “0.”
- To enter a one-digit or two-digit channel number, press the **Ⓜ Numeric keys** on the remote control and then press **Ⓜ ENT** to confirm the input number.
- Instead of pressing **Ⓜ ENT** to tune into the channel immediately, you can wait a few seconds until this unit confirms the entered channel number.
- If no key is pressed within a few seconds after you enter a one-digit or two-digit number, this unit automatically confirms the entered channel number.
- If the selected channel is locked, “PIN:\_\_\_” appears on the front panel display. Enter the four-digit Parental Lock code number by using the **Ⓜ Numeric keys** or press **Ⓜ ENT** to cancel (see page 38).
- If the selected channel is not available, an advisory message may appear. For details, see “SIRIUS Satellite Radio” on page 66.
- If you operate **Ⓜ Numeric keys** in preset search mode (see next page), a preset number is selected. If you want to directly select a channel number, press **Ⓜ TUNING/CH** </> (or **Ⓜ TUN./CH** Δ / ▽) to switch to All Channel Search mode and enter the number.



## Registering the SIRIUS Satellite Radio™ channels

You can use this feature to store up to 40 SIRIUS Satellite Radio channels. You can then recall any preset channel easily by selecting the preset channel group and number as described in “Calling a preset channel (Preset Search mode)” on this page.

### Registering preset channels

#### 1 Search a channel you want to set as a preset channel in one of the SIRIUS Satellite Radio search modes.

For details, see “SIRIUS Satellite Radio operations” (see page 35).

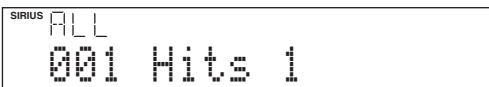

#### 2 Press **MEMORY** (or **MEMORY**).

The indicator on the front panel display changes as follows.

Currently registered channel number  
(or “----” if empty)



Channel number to be registered

Preset number to which new channel number is registered



- To store the selected channel under an empty preset number automatically, press and hold **MEMORY** (or **MEMORY**) for more than 2 seconds instead of step 2. In this case, the following steps are unnecessary.
- To cancel the preset operation, press **RETURN**.

#### 3 Press **PRESET** $\triangleleft/\triangleright$ (or **PRESET** $\triangle/\nabla$ ) to select the stored preset station number.

##### Notes

- You can also select a preset number by pressing the **Numeric keys**.
- If you select a preset number being used (“\*” appears next to the preset number), the current preset channel will be overwritten.

#### 4 Press **MEMORY** (or **MEMORY**).

The selected channel is stored as a preset channel.

## Calling a preset channel (Preset Search mode)

Prior to selecting a preset channel in the Preset Search mode, you must preset SIRIUS channels. For details, see “Registering preset channels” on this page.

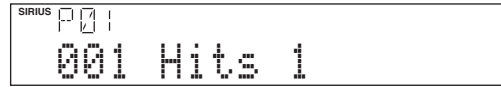

Press **PRESET**  $\triangleleft/\triangleright$  (or **PRESET**  $\triangle/\nabla$ ) repeatedly to change the preset channel number (1 to 40).

### Clearing preset channels

You can clear the assignments of preset SIRIUS Satellite Radio channels.

#### 1 Press **OPTION** on the remote control.

The option menu is displayed on the front panel display.

#### 2 Press **Cursor** $\nabla$ repeatedly to select “Clear Preset” and then press **ENTER**.

#### 3 Press **Cursor** $\triangle/\nabla$ to select the preset station number that you want to clear.

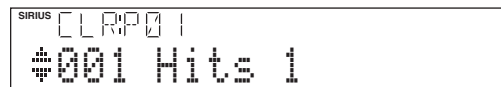

#### 4 Press **ENTER** to execute the clearing of the selected preset channel.

To clear the registration of multiple preset numbers, repeat the above steps. To end the operation, press **OPTION**.

## Setting the Parental Lock

You can use the Parental Lock feature to limit the access to the desired SIRIUS Satellite channels. This unit automatically skips the locked channels when this unit is in the All Channel Search mode or Category Search mode and you search a channel by pressing **1** **TUNING/CH**  $\triangleleft/\triangleright$  (or **9** **TUN./CH**  $\triangle/\nabla$ ).

### Setting the code number and the locking channels

Use this feature to set the Parental Lock code number (PIN) and select the channels to be locked.

- 1** Press **14** **OPTION** on the remote control. The option menu is displayed on the front panel display and video monitor.
- 2** Press **15** **Cursor**  $\nabla$  repeatedly to select “Parental Lock” and then press **15** **ENTER**.
- 3** Enter the desired 4-digit code number by using the **15** **Cursor**  $\triangle/\nabla$   $\triangleleft/\triangleright$ .  
If you have entered a code number before, enter the same code number.

The entered code number is needed for tuning in the channel or unlocking the channel. Write it down the space provided below.  
Code number: \_\_\_\_\_

- 4** Press **15** **ENTER** twice to confirm the code number.  
A confirmation screen appears with the first press. When you press again, “OK” and then the SIRIUS Satellite Radio channel list appears.

#### Note

- If a code number is already registered and you enter the different number, “Wrong” appears and the screen returns to step 3. Enter the correct code number.

- 5** Press **15** **Cursor**  $\triangleleft/\triangleright$  to select a category of that channel and a channel you want to lock.

Page number in the category

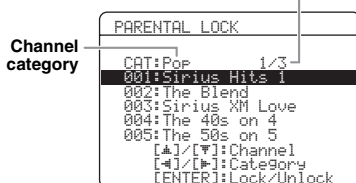

- 6** Press **15** **Cursor**  $\triangle/\nabla$  to select a channel you want to lock.

### Notes

- You can also select a channel by using **9** **CATEGORY**  $\triangleleft/\triangleright$  or **9** **TUN./CH**  $\triangle/\nabla$ .
- While the SIRIUS Satellite Radio channel list screen is displayed, sound of the selected channel is output even the channel is locked.

- 7** Press **15** **ENTER** to lock the selected channel.

A check mark appears next to the locked channel on the video monitor. You can toggle channel lock and unlock as you press **15** **ENTER**.

Locked channel

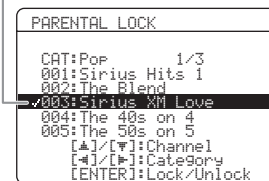

- 8** Repeat steps 5 and 7 to lock all the desired channels.

- 9** Press **15** **RETURN** repeatedly to exit the “PARENTAL LOCK” screen.

This unit is tuned into the last channel you select in the “PARENTAL LOCK” screen. If the channel is locked, this unit is tuned into “184 SIRIUS Weather & Emergency” or “000 Sirius ID.”



- If you forget the Parental lock code or want to change it, reset it using “SR PIN” (see page 60).

### Tuning into the locked channels

If you want to tune in the locked channels, set this unit to Direct number access mode or preset tuning mode. When you tune into the locked channel, “LOCKED” appears on the front panel display and video monitor, followed by the following message. Enter the set Parental lock code by using the **20** **Numeric keys**. To cancel this operation, press **20** **ENT**.

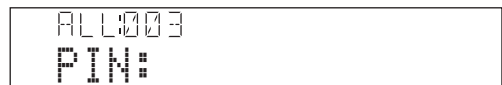

#### Note

- If an incorrect number is entered, “Wrong” appears on the front panel display or the video monitor and this unit is tuned into the previously selected channel.

## Displaying the SIRIUS Satellite Radio™ information

Use this feature to display the SIRIUS Satellite Radio information on the front panel display or on the OSD.

### Note

- If a status message or an error message appears on the front panel display or video monitor, see “SIRIUS Satellite Radio” (see page 66).

### ■ Front panel display

Press **Ⓜ** **INFO** (or **Ⓜ** **INFO**) repeatedly to toggle the following SIRIUS Satellite Radio information display modes.

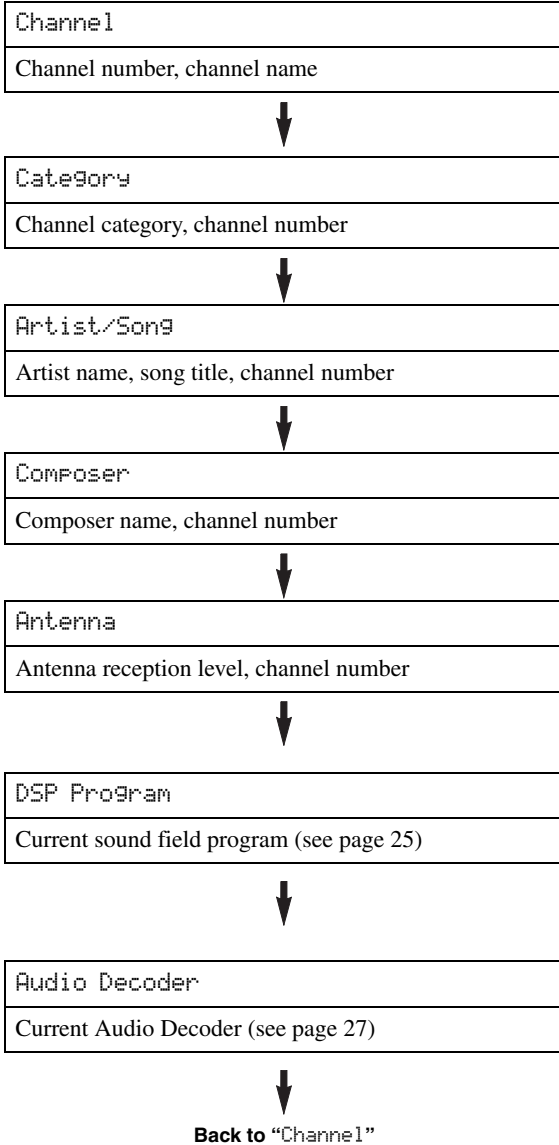

### Front Panel Display (example)



- If the SIRIUS Satellite Radio information contains a character that cannot be recognized by this unit, the character will be displayed with a space.
- When the antenna of the SiriusConnect tuner cannot receive the signals, “ACQUIRING” appears on the front panel display.
- When an information is unavailable, “—” appears.

### ■ Video monitor (OSD)

Press **Ⓜ** **DISPLAY** on the remote control to turn on or off the information display.

The following information is displayed on the OSD.



- ① Search mode (see page 35)
- ② Channel category
- ③ Song title
- ④ Antenna reception level
- ⑤ Channel number/name
- ⑥ Artist name
- ⑦ Composer name



- To turn off the OSD, press **Ⓜ** **DISPLAY**.
- You can hold the music information screen or release it by **Ⓜ** **ENTER**.

# Using iPod™

Once you have stationed your iPod in a Yamaha iPod universal dock (such as the YDS-11, sold separately) connected to the DOCK terminal on the rear panel of this unit (see page 17), you can enjoy playback of your iPod using the supplied remote control or the menu displayed on the video monitor. You can also use the Compressed Music Enhancer mode of this unit to improve the sound quality of the compression artifacts (such as MP3 format) stored on your iPod (see page 27).

## Notes

- iPod touch, iPod (Click and Wheel including iPod classic), iPod nano, and iPod mini are supported.
- Some features may not be compatible depending on the model or the software version of your iPod.
- Some features may not be available depending on the model of Yamaha iPod universal dock. The following sections describe the procedure when using the YDS-11.



- Once the connection between your iPod and this unit is complete, “iPod connected” appears on the front panel display.
- For a complete list of status messages that appear on the front panel display and on the video monitor, see the “iPod” section on page 68.

## Controlling iPod™

You can control your iPod when you set it in the iPod universal dock and switch the input source to DOCK. The operations of your iPod can be done with the aid of the video display (menu browse mode) or without it (simple remote mode).

When you connect your iPod to this unit, you can perform the following operations with the remote control.

key	Function
ENTER	Subsequent menu
△	Menu up
[15] ▽	Menu down
◀	Previous menu
▶	Subsequent menu
◀◀	Search backward (Press and hold)
▶▶	Search forward (Press and hold)
▶▶	Skip forward
◀◀	Skip backward
[19] □	Stop
⏸	Pause (Menu browse mode) Play/Pause (Simple remote mode)
▶	Play (Menu browse mode) Play/Pause (Simple remote mode)
[17] DISPLAY	Switch between Menu browse mode and Simple remote mode

## Controlling iPod in simple remote mode

You can perform basic iPod operations (play, stop, skip, etc.) using the supplied remote control without displaying the menu on the video monitor. You can also directly control your iPod in this mode.

## Controlling iPod in menu browse mode

You can perform advanced iPod operations using the remote control while looking at the menu displayed on the video monitor. You can browse the song files or video files stored on your iPod and displayed on the monitor, and change the settings of your iPod to suit your personal preferences. You cannot directly control your iPod in this mode.



- “\_” (underscore) is displayed for characters that this unit cannot display.

**1** Change the input source to “iPod (DOCK)” using **ⓄINPUT** </> (or **[8]DOCK**).

**2** Press **[17]DISPLAY** on the remote control.

The following screen appears on the video monitor.



**3** Press **[15]Cursor** △ / ▽ to select “Music,” “Videos” or “Settings” and press **[15]Cursor** ▶.

- Select “Music” to browse music files.
- Select “Videos” to browse video files.

## Note

- “Videos” will not be displayed when your iPod or Yamaha iPod universal dock do not support the browser function for browsing video files.

- 4 Press **[15]Cursor**  $\Delta$  /  $\nabla$  /  $\triangleleft$  /  $\triangleright$  to select a menu item and then **[15]ENTER** to start playback.

#### Menu items of “Music”

Playlists, Artists, Albums, Songs, Genres, Composers

- Playlists > Songs
- Artists > Albums > Songs
- Albums > Songs
- Songs
- Genres > Artists > Albums > Songs
- Composers > Albums > Songs

#### Menu items of “Videos”

Menu items vary depending on the files stored on your iPod.

#### ■ Description of the play information display



- ① Track number/total tracks
- ② Artist name
- ③ Album title
- ④ Song title
- ⑤ Progress bar
- ⑥ Elapsed time
- ⑦ Shuffle and repeat icons
- ⑧  $\blacktriangleright$  (playback),  $\mathbb{I}$  (pausing),  $\blacktriangleright\blacktriangleright$  (search forward) and  $\blacktriangleleft\blacktriangleleft$  (search backward)
- ⑨ Remaining time



- You can change information screens on the front panel display using **[15]INFO** (or **[10]INFO**) (see page 24). Items displayed on the front panel display vary depending on mode that is currently selected.

## Shuffle/repeat playback

You can use a special playback function such as shuffle playback and repeat playback by setting the option menu.

- 1 Press **[17]DISPLAY** to switch to menu browse mode while “DOCK” is selected as the input source.

The option menu can be displayed only in menu browse mode. Press **[17]DISPLAY** to switch to menu browse mode before starting shuffle or repeat playback.

- 2 Press **[14]OPTION**.

The option menu is displayed.

- 3 Press **[15]Cursor**  $\Delta$  /  $\nabla$  to select the desired playback function, Shuffle or Repeat, then press **[15]ENTER**.

The following playback styles are available depending on the playback function selected.

**Shuffle:** Plays back songs or albums in random order (Choices: Off, Songs, Albums).

- Select “Off” if you do not want to play back in random order.
- Select “Songs” to play back songs in random order.
- Select “Albums” to play back albums in random order.

**Repeat:** Plays back songs or albums repeatedly (Choices: Off, One, All).

- Select “Off” if you do not want to play back repeatedly.
- Select “One” to repeat each song.
- Select “All” to repeat all songs.

- 4 Select the desired style using **[15]Cursor**  $\triangleleft$  /  $\triangleright$ .

The style is selected. Playback starts with the function selected in step 2.

To return to the previous screen, press **[15]RETURN**. To return to the previous playback function, redo the above steps.



- When the shuffle function is on, “ $\mathbb{I}$ ” appears on the video monitor.
- When “Repeat” is set to “One” or “All,” “ $\phi$ ” or “ $\phi_{All}$ ” appears on the video monitor.

# Using Bluetooth™ components

You can connect a Yamaha Bluetooth wireless audio receiver (such as YBA-10, sold separately) to the DOCK terminal of this unit and enjoy the music contents stored in your Bluetooth component (such as a portable music player) without wiring between this unit and the Bluetooth component. You need to perform “Pairing” the connected Bluetooth wireless audio receiver and your Bluetooth component in advance.

## Note

- This unit supports A2DP (Advanced Audio Distribution Profile) of the Bluetooth profile.

## Pairing the Bluetooth™ wireless audio receiver and your Bluetooth component

“Pairing” refers to the operation of registering a Bluetooth component for Bluetooth communications. Pairing must be performed when using a Bluetooth component with the Bluetooth wireless audio receiver connected to this unit for the first time or if the pairing data has been deleted.



- You only need the pairing operation for the first time that you use the Bluetooth component with the Bluetooth wireless audio receiver.
- Pairing requires operations on this unit and on the other component with which Bluetooth communications are to be established. If necessary, refer to the other component’s operating instructions.

### ■ Pairing the Bluetooth™ wireless audio receiver and your Bluetooth™ component

To ensure security, a time limit of 8 minutes is set for the pairing operation. You are recommended to read and fully understand all the instructions before starting.

**1** Change the input source to “DOCK” using **⊙**INPUT </> (or **Ⓚ**DOCK).

**2** Turn on the Bluetooth component you want to pair with and set it to pairing mode.

For details on operation of the Bluetooth component, refer to its operating instructions.

**3** Press **Ⓛ**OPTION.

The option menu for DOCK input appears on the video monitor.

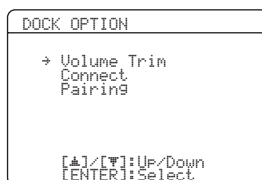

**4** Press **Ⓛ**Cursor ▾ to select “Pairing” and press **Ⓛ**ENTER.

“Searching” appears on the front panel display and the pairing operation starts.



- To cancel pairing, press **Ⓛ**RETURN.
- You can also start pairing operation by pressing and holding **Ⓛ**MEMORY on the front panel.

**5** Make sure the Bluetooth component recognizes the Bluetooth wireless audio receiver.

If the Bluetooth have recognized the Bluetooth wireless audio receiver, “YBA-10 YAMAHA,” for instance, is displayed in the Bluetooth device list.

**6** Select the Bluetooth wireless audio receiver from the Bluetooth device list, and enter a path key “0000” into the Bluetooth component.

When pairing is complete, “Completed” appears on the front panel display.



- The Yamaha Bluetooth wireless audio receiver can be paired with up to eight Bluetooth components. When pairing is conducted successfully with a ninth component and the pairing data is registered, the pairing data for the least recently used other component is cleared.

## Playback of the Bluetooth™ component

**1** Change the input source to “DOCK” using **⊙**INPUT </> (or **Ⓚ**DOCK).

**2** Press **Ⓛ**OPTION.

**3** Press **Ⓛ**Cursor ▾ repeatedly to select “Connect” and press **Ⓛ**ENTER.

After you execute “Connect,” communication with the Bluetooth component is established. When the connected Bluetooth wireless audio receiver recognizes the Bluetooth component, “BT Connected” appears on the front panel display.



- When you press **Ⓛ**ENTER on the remote control, the connected Bluetooth wireless audio receiver searches and connects to the last connected Bluetooth component. If the Bluetooth wireless audio receiver cannot find the Bluetooth component, “Not found” appears on the front panel display.
- To disconnect the Bluetooth wireless audio receiver from the Bluetooth component, display the option menu again, select “Disconnect,” and press **Ⓛ**ENTER.

**4** Start playback of the Bluetooth component.

# ADVANCED OPERATION

## Setting the option menu for each input source (OPTION menu)

This unit has an OPTION menu of frequently used menu items for input sources compatible with this unit. The procedure for setting the OPTION menu items is described below.

**1 Select an input source using **Ⓢ**INPUT </> (or **Ⓢ**Input selection keys).**

**2 Press **Ⓢ**OPTION on the remote control.**

The OPTION menu appears. The displayed OPTION menu items differ depending on the input source. For details, see the following section.

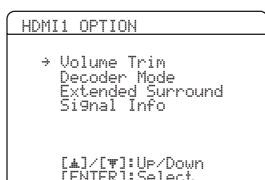

**3 Select the desired menu item using **Ⓢ**Cursor ▲ / ▼, and press **Ⓢ**ENTER.**

Parameters of the selected menu item are displayed.

**4 Change the setting of the selected menu item (or enable a function) using **Ⓢ**Cursor ▲ / ▼ / </> and **Ⓢ**ENTER.**

Details of the selected menu item are displayed.

Parameters you can set differ depending on the menu items.

**5 To close the OPTION menu, press **Ⓢ**OPTION.**

You can also use **Ⓢ**RETURN to return to the previous screen or close the OPTION menu.



- When **Ⓢ**Cursor or other keys do not work after completing the menu, select the input source again using **Ⓢ**Input selection keys.

### OPTION menu items

The following menu items are provided for each input source.

Input Source	Menu item			
HDMI1-4	Volume Trim	Decoder Mode	Extended Surround	Signal Info
AV1-4	Volume Trim	Decoder Mode	Extended Surround	Signal Info
AV5-6	Volume Trim			
AUDIO1-2	Volume Trim			
V-AUX	Volume Trim			
TUNER	Volume Trim	FM Mode	Auto Preset	Clear Preset
XM	Volume Trim	Clear Preset		
SIRIUS	Volume Trim	Parental Lock	Clear Preset	
iPod (DOCK)	Volume Trim	Shuffle	Repeat	
Bluetooth (DOCK)	Volume Trim	Connect/ Disconnect	Pairing	
MULTI CH	Volume Trim	Video Out		

Details of the menu items are as follows:



- The default settings are marked with “\*.”

#### ■ Volume Trim

**Input source:** All

**Adjustable range:** -6.0 dB to 0.0 dB\* to +6.0 dB  
(in 0.5 dB steps)

Reduces any change in volume when switching input sources by correcting volume differences between input sources.

You can set this parameter for each input source.

## ■ Decoder Mode

**Input source:** HDMI1-4, AV1-4

**Choices:** Auto\*/DTS

Selects DTS digital audio signals for reproduction.

**Auto** Automatically selects audio input signals.

**DTS** Selects DTS signals only. Other input signals are not reproduced.

## ■ Extended Surround

**Input source:** HDMI1-4, AV1-4

**Choices:** Auto\*/PLIIXMovie/PLIIXMusic/EX/ES/Off

Selects whether to reproduce multi-channel input signals in 6.1- or 7.1-channel when surround back speakers are used.

**Auto** Automatically selects the most suitable decoder according to whether a flag for reproducing surround back channel is present, and reproduces the signals in 6.1- or 7.1-channel.

**PLIIXMovie** Always reproduces signals in 6.1- or 7.1-channel using the PLIIXMovie decoder whether or not surround back channel signals are contained. You can select this parameter when one or two speakers are connected.

**PLIIXMusic** Always reproduces signals in 6.1- or 7.1-channel using the PLIIXMusic decoder whether or not surround back channel signals are contained. You can select this parameter when one or two speakers are connected.

**EX/ES** Automatically selects the most suitable decoder for input signals whether or not the flag for reproducing surround back channel is present, and always reproduces signals in 6.1-channel.

**Off** Always reproduces signals in 5.1-channel whether or not the flag for reproducing surround back channel is present.

## ■ Signal Info

**Input source:** HDMI1-4, AV1-4

Displays information on audio and video signals on the video monitor and front panel display. You can change items to be displayed using **[F5]Cursor**  $\Delta$  /  $\nabla$ .

### Signal Info parameters

#### ■ Audio information

Information	Description
Format	Format of digital audio signals.
Channel	The number of input signal channels (front/surround/LFE). For example, if input signal channels are 3 front channels, 2 surrounds and LFE, "3/2/0.1" is displayed. If a channel that cannot be expressed as the above, a total number of channels such as "5.1ch" may be displayed.
Sampling	The sampling frequency per second in analog-to-digital conversion.
Bitrate	The bit rate of input signal per second.

#### Notes

- "No Signal" is displayed when no signals are input and "---" is displayed when signals that this unit cannot recognize are input.
- The bit rate may vary during playback.

#### ■ Video information

Information	Description
In	Format and resolution of video input signal.
Out	Format and resolution of video output signal.
Message	Error messages about HDMI signals and HDMI components. See the following for details of the error messages.

#### HDMI error message

(appears only when an error has occurred)

HDCP Error	HDCP authentication failed.
Device Over	The number of HDMI components connected is over the limit.
Out of Res.	The connected monitor is not compatible with the video input signal.

## ■ FM Mode

**Input source:** TUNER

**Choices:** Stereo\*/Mono

Sets FM broadcasting receiving mode.

**Stereo** Receives in stereo mode.

**Mono** Receives in monaural mode. You can get a better reception in MONO mode.



### ■ Auto Preset

**Input source:** TUNER

Automatically detects radio stations in the FM frequency band and registers them as preset stations (see page 29).

### ■ Clear Preset

**Input source:** TUNER, XM, SIRIUS

When TUNER is selected: See page 30.

When XM is selected: See page 33.

When SIRIUS is selected: See page 37.

### ■ Parental Lock

**Input source:** SIRIUS

Set the Parental Lock (see page 38).

### ■ Shuffle

**Input source:** iPod (DOCK)

**Choices:** Off\*/Songs/Albums

Changes the shuffle playback style (see page 41).

### ■ Repeat

**Input source:** iPod (DOCK)

**Choices:** Off\*/One/All

Changes the repeat playback style (see page 41).

### ■ Connect/Disconnect

**Input source:** Bluetooth (DOCK)

Switches communication with a Bluetooth component on and off (see page 42).

### ■ Pairing

**Input source:** Bluetooth (DOCK)

Performs pairing of this unit and a Bluetooth component (see page 42).

### ■ Video Out

**Input source:** MULTI CH

**Choices:** AV1 to 6/U-AUX/Off\*

When the multi-channel input is selected, an input signal input from another terminal is outputted to the video monitor. See “Outputting a video signal input from another input source during reproducing a multi-channel audio signal” on this page.

## Outputting a video signal input from another input source during reproducing a multi-channel audio signal

When “MULTI” is selected as the input source, a video signal input from another terminal can be output to the video monitor. For example, even if an audio and video component such as a DVD player that does not support a multi-channel digital audio output, the video signal can be output to the video monitor while reproducing a multi-channel analog audio signal.

- 1 Press **Ⓞ**INPUT </> (or **Ⓜ**MULTI) to change the input source to “MULTI CH.”
- 2 Press **Ⓟ**OPTION on the remote control. The OPTION menu appears.
- 3 Press **Ⓛ**Cursor  $\Delta$  /  $\nabla$  to display “Video,” and press **Ⓛ**ENTER.

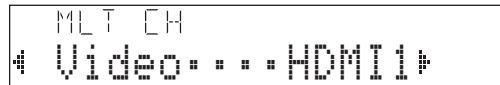

- 4 Press **Ⓛ**Cursor </> to select a video input terminal from the following to input a video signal that is output to the video monitor during reproducing a multi-channel audio signal.
  - AV1-2 (COMPONENT VIDEO terminal)
  - AV3-6 (COMPOSIT terminal)
  - V-AUX (COMPOSIT terminal)
  - Off (no video output)
- 5 To end the setting, press **Ⓟ**OPTION.

# Editing surround decoders/sound field programs

## Selecting a decoder used with a sound field program

When using sound field programs for movies or TV programs (except for Mono Movie), you can select a surround decoder to be used with the sound field program after setting the parameters from the following decoders. To set the parameters for sound field programs, see the following section.

### Decoders that can be used with a sound field program

- PLIIx Movie (PLII Movie)
- Neo:6 Cinema

## Setting sound field parameters

Although the field sound programs would satisfy you as they are with the default parameters, you can arrange sound effect or decoders suitable for acoustical conditions of sources or rooms by setting the parameters (sound field elements).



- You can protect the sound field against the changes of parameters the sound fielded parameters when “Memory Guard” of the setup menu is set to “On” (see page 56). To change the parameters, set it to “Off.”

**1 Turn on the video monitor connected to this unit.**

**2 Press [F3]SETUP on the remote control.**  
The setup menu appears on the monitor.

**3 Press [F5]Cursor  $\Delta$  /  $\nabla$  to select “DSP Parameter” and press [F5]ENTER.**

The screen changes as follows.

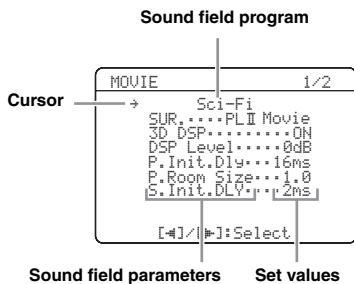

**4 Press [F5]Cursor  $\Delta$  /  $\nabla$  to move “→” to the sound field program and press [F5]Cursor  $\triangleleft$  /  $\triangleright$  to select the sound field program.**

**5 Press [F5]Cursor  $\Delta$  /  $\nabla$  to select the parameter that you want to change, and press [F5]Cursor  $\triangleleft$  /  $\triangleright$  to change the parameter.**

An asterisk (\*) appears on the left of the sound field parameter name displayed on the monitor when you change the parameter from its default setting. For details on functions and adjustable ranges of the sound field parameters, see “Sound field parameters” on this page.



- Repeat steps 4 and 5 to change other sound field program parameters.
- A complete list of the parameters of some sound field programs may exceed one page. In this case, press [F5]Cursor  $\Delta$  /  $\nabla$  to scroll through pages.

**6 To end the edit, press [F3]SETUP.**

To initialize the parameters of the selected sound field program, [F5]Cursor  $\nabla$  repeatedly to select “Initialize” and then press, [F5]Cursor  $\triangleright$ . When the confirmation screen appears on the monitor, press [F5]Cursor  $\triangleright$  to confirm the initialization or [F5]Cursor  $\triangleleft$  to cancel it.

## Sound field parameters



- The default settings are marked with “\*.”

### CINEMA DSP basic parameters

#### DSP Level

**Adjustable range:** -6 dB to 0 dB\* to +3 dB

Fine adjusts an effect level (level of the sound field effect to be added). You can adjust the level of the sound field effect while checking sound levels. Adjust “DSP Level” as follows.

- The effect sound is too soft.  
→Increase the effect level.
- There are no differences between effects of the sound field programs.
- The sound is dull.  
→Reduce the effect level.
- The sound field effect is added too much.  
→Reduce the effect level.

## Dialog Lift

Choices: 0\* to 5

Use this feature to adjust the vertical position of the dialogues in movies. The ideal position of the dialogues is at the center of the video monitor screen.

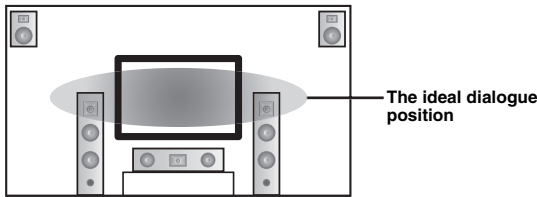

If the dialogues are heard at the lower position of the video monitor screen, increase the value of "Dialog Lift."

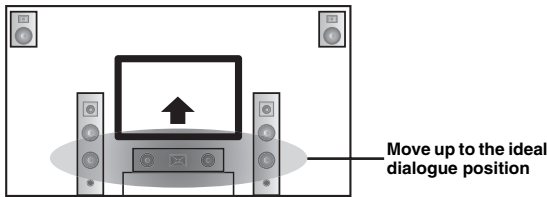

When the value is set to zero, the position is at the lowest. The position gets higher as you increase the value.

### Notes

- "Dialog Lift" is displayed only when the presence speakers are available.
- You cannot move the dialogue position lower than the default setting.

## Sound field parameters for the advanced configurations

### ■ Parameter for CINEMA DSP 3D

#### 3D DSP

Choices: On\* / Off

When CINEMA DSP 3D is enabled, sets whether to use sound field programs in 3D mode.

### Note

- When the presence speakers are not used, the 3D DSP parameters are not displayed.

### ■ Parameters for adjusting early-reflected sound

Parameter	Adjustable range
Init.Dly	1 to 99ms
P.Init.Dly	1 to 99ms
S.Init.Dly	1 to 49ms
SB Init.Dly	1 to 49ms

Adjusts attenuation characteristics of early-reflected sound. You can create a lively sound field (with a high reverberant sound level) as you increase the value, and a dead sound field (with a low reverberant sound level) as you decrease the value. Creating either a lively sound field or a dead sound field in an actual music hall is determined by the acoustic absorption characteristics of reflection surfaces. A dead sound field is created when the attenuation time is short while a lively sound field is created when the attenuation time is long.

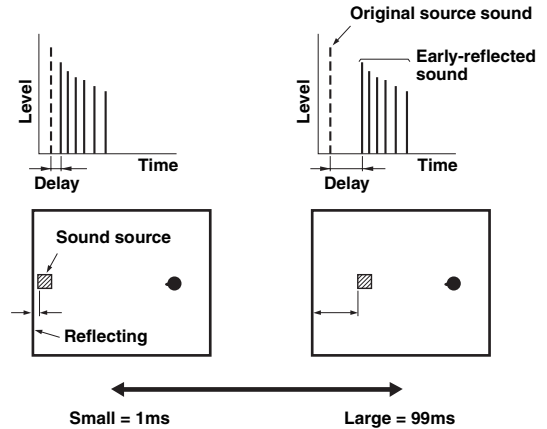

- We recommend that you adjust the size of corresponding sound field when you adjust the delay time.

### ■ Parameters for specifying room size

Parameter	Adjustable range
Room Size,	0.1 to 2.0
P.Room Size,	
S.Room Size,	
SB Room Size	

Produces different senses of sound expansion according to room sizes specified. In a large size room such as a music hall, the duration from when reflected sound is heard until when the next reflected sound is heard is long. Thus, different senses of sound expansion can be created by changing the duration. 1.0 is the original room size. When this parameter is set to 2.0, each side of the room is defined as twice larger than the original room size.

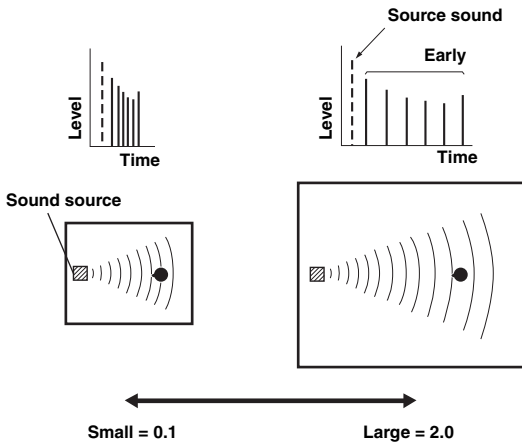

**Parameters for defining attenuation characteristics of early-reflected sound**

Parameter	Adjustable range
Liveness	0 to 10
S.Liveness	0 to 10
SB Liveness	0 to 10

Adjusts the attenuation of reflected sound. You can create a lively sound field (with a high reverberant sound level) as you increase the value, and a dead sound field (with a low reverberant sound level) as you decrease the value. Creating either a lively sound field or a dead sound field in an actual music hall is determined by the acoustic absorption characteristics of reflection surfaces. A dead sound field is created when the attenuation time is short while a lively sound field is created when the attenuation time is long.

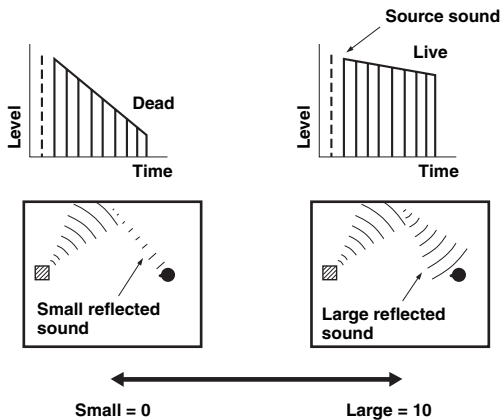

**Parameters for adjusting reverberant sound**

Parameter	Adjustable range
Rev.Time	1.0 to 5.0s
Rev.Delay	0 to 250ms
Rev.Level	0 to 100%

Rev.Time parameter adjusts the attenuation time of the rear reverberant sound based on the time that about 1kHz reverberant sound takes for 60dB of attenuation. Reverberant sound attenuates faster as you decrease the value. Rev.Time adjustment allows you to create a natural reverberant sound, by setting the attenuation time longer for a sound source or room with less echo, or shorter for a sound source or room with more echo.

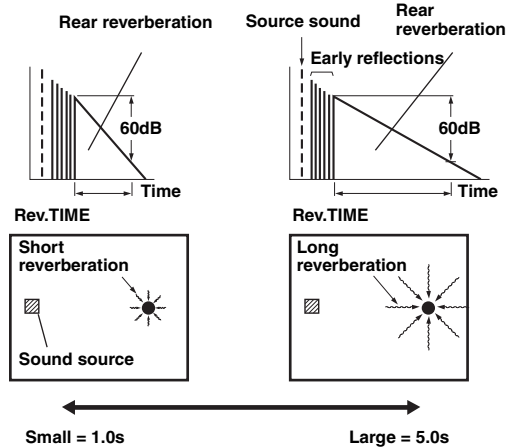

Rev.Delay parameter adjusts the time difference between the beginning of the direct sound and the beginning of the reverberation sound. The larger the value, the later the reverberation sound begins. Increasing the value of Rev.Delay allows you to create a reverberant sound in a wider area for the same Rev.Time.

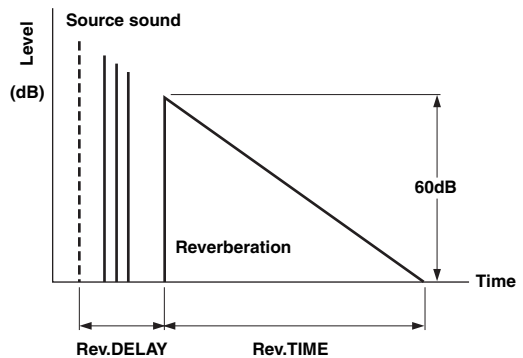

Rev.Level parameter adjusts the reverberation sound level. Increasing the value of Rev.Level makes the reverberation sound level higher, which allows you to create more echo.

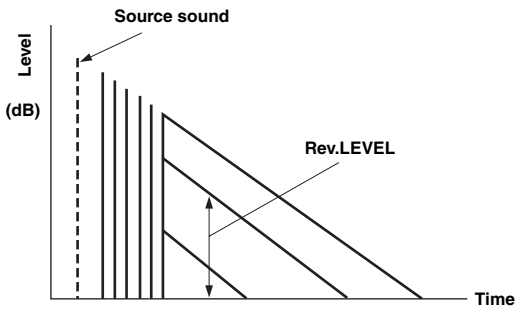

### Parameters only usable in certain sound field programs

#### 2ch Stereo only

##### Direct

**Choices:** Auto\*/Off

Automatically bypasses the DSP circuit and tone control circuit when an analog sound source is selected as the input source. You can enjoy a higher quality sound.

**Auto** Outputs sound by bypassing the DSP circuit and tone control circuit when the “Bass” and “Treble” tone controls are both set to 0 dB.

**Off** Do not bypass the DSP circuit and tone control.

#### 7ch Stereo only

##### CT Level/SL Level/SR Level/ SB Level

**Adjustable range:** 0 to 100%

Adjusts the volume of the center (CT), surround L (SL), surround R (SR) and surround back (SB) channels in the 7ch Stereo program. The available parameters differ depending on the setting of the speakers.

#### Straight Enhancer/7ch Enhancer only

##### Effect Level

**Choices:** High\*/Low

Adjusts the Compressed Music Enhancer effect level. When the high-frequency signals of the source is emphasized too much, set the effect level to “Low.” To reduce the effect, set this parameter to “Low.” To increase the effect, set it to “High.”

### Decoder parameters

You can customize decoder effects by setting the following parameters. For kinds of decoders, see page 27.

#### When PLIIx Music/PLII Music is selected

##### Panorama

**Choices:** Off\*/On

Adjusts the soundscape of the front sound field. Sends stereo signals to the surround speakers as well as the front speakers for a wraparound effect.

##### Dimension

**Adjustable range:** -3 to STD\* to +3

Adjusts the difference in level between the front sound field and the surround sound field. You can adjust the difference in level created by the software being played back to obtain the preferred sound balance. The surround sound gets stronger as you make the value more negative and the front sound gets stronger as you make the value more positive.

##### Center Width

**Adjustable range:** 0 to 3\* to 7

You can spread the center sound toward left and right according to your preference. Set this parameter to 0 for outputting the center sound from the center speaker only, or to 7 for outputting it from the front left/right speaker.

#### When Neo:6 Music is selected

##### C. Image

**Adjustable range:** 0.0 to 0.3\* to 1.0

Adjusts the front left and right channel output relative to the center channel to make the center channel more or less dominant as necessary.

# Operating various settings for this unit (Setup menu)

You can call the setup menu using the remote control and change the settings of various menus.

You can change the following settings in the setup menu. For details, read “Basic operation of the setup menu” first, and see the respective pages.

Menu/Submenu	Function	Page
Speaker Setup	Sets items for speakers.	51
1 Auto Setup (YPAO)	Automatically adjusts output characteristics of speakers.	51
2 Manual Setup	Manually adjusts output characteristics of speakers.	51
A)Config	Sets speaker configurations, such as connection status of speaker and a size of the connected speaker (sound reproduction capacity), suitable for the listening environment.	51
B)Level	Separately adjusts volume of each speaker.	53
C)Distance	Adjusts timing at which each speaker outputs sound based on distances between speakers and the listening position.	53
D)Equalizer	Selects an equalizer that adjusts speaker output characteristics.	53
E)Test Tone	Generates test tones.	53
Sound Setup	Sets various items for sound outputs.	53
1 Dynamic Range	Adjusts dynamic ranges of speakers and headphones.	53
2 Lipsync	Adjusts delay in output timing between video signals and audio signals.	54
HDMI Auto	Sets on or off of automatic adjustments for delay between output timing between video signals input from the HDMI jack and audio signals.	54
Auto Delay	Fine adjusts a delay time of HDMI Auto.	54
Manual Delay	Manually fine adjusts the delay of audio and visual output.	54
Function Setup	Set various items for HDMI and display.	54
1 HDMI	Sets various items for input sources.	54
Standby Through	Selects on or off of output of HDMI signals input from the HDMI IN jack to the HDMI OUT jack when this unit is on standby.	54
Audio Output	Selects this unit or a component connected to this unit via the HDMI OUT jack of this unit for reproducing sound signals input from the HDMI IN jack.	54
Resolution	Sets resolution of the HDMI output that is converted from analog visual input signals.	54
Aspect	Set an aspect ratio of images reproduced by HDMI signals converted from analog video input signals.	54
2 Display	Set items for a monitor or the front panel display.	55
Dimmer	Sets brightness of the front panel display.	55
FL Scroll	Selects the way to display characters on the front panel display.	55
OSD Shift	Adjusts top and bottom positions of the screen displayed on the video monitor.	55
3 Volume	Sets items for volumes.	55
Adaptive DRC	Adjust the dynamic range (difference between the maximum volume and the minimum volume) in conjunction with the volume level.	55
Max Volume	Sets the maximum volume level so that the volume will not be accidentally increased.	55
Init. Volume	Sets the volume at the time this unit is turned on.	55
4 Input Rename	Changes input source names to be displayed on a video monitor or the front panel display.	55
5 Zone2	Sets the maximum volume level and initial volume level of Zone2.	56
Max Volume	Sets the maximum volume level so that the volume will not be accidentally increased.	56
Init. Volume	Sets the volume at the time this unit is turned on.	56
DSP Parameter	Sets parameters for the sound field programs.	56
Memory Guard	Protects some settings against accidental alteration.	56

## Basic operation of the setup menu

The setup menu screen appears on both video display (OSD) and front panel display.

### Video display (OSD)



### Front panel display



In this section, procedures of setting menus using the video monitor are described.

#### 1 Press **SETUP** on the remote control.

The setup menu screen appears.

#### 2 Select a menu using **Cursor** $\Delta$ / $\nabla$ , and press **ENTER**.

Items of the selected menu are displayed. For example, the following screen appears when you select “Function Setup.”

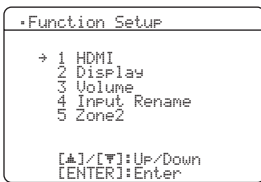

You can return to the previous screen by pressing **RETURN**.

#### 3 To display submenus, select a menu that you want to set using **Cursor** $\Delta$ / $\nabla$ , and press **ENTER**.

For example, the following screen appears when you select “2 Display.”

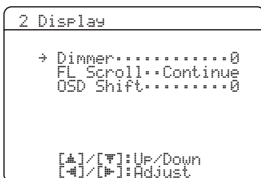

#### 4 Select an item using **Cursor** $\Delta$ / $\nabla$ , and change the setting of the item using **Cursor** $\leftarrow$ / $\rightarrow$ .

Some items in the Manual Setup menu of Speaker Setup take up a full screen. To display other items in the Manual Setup menu, press **Cursor**  $\Delta$  /  $\nabla$ .

### “A)Config” display (example)

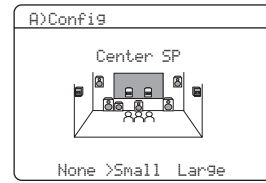

You can change other items by repeating step 4.

### 5 To finish the setting, press **SETUP**.



When **Cursor** or other keys do not work after completing the menu, select the input source again using **Input selection keys**.

## Speaker Setup

You can set various items for speakers. Two kinds of adjustments are available. One is “Auto Setup (YPAO)” for automatic adjustment and another is “Manual Setup” for manual adjustment.



The default settings are marked with “\*.”

### 1 Auto Setup

Automatically adjusts output characteristics of speakers to obtain optimum balance for the output sound based on positions and performances of the speakers and acoustic characteristics of the room, which are automatically measured. For details on operations, see page 19.

### 2 Manual Setup

Adjusts output characteristics of speakers based on manually set parameters.

After Auto Setup (YPAO) is performed, you can check automatically adjusted parameters in the Manual Setup menu. Fine adjust the parameters for your preference if necessary.

#### A)Config

Sets speaker configurations, such as connection status of speaker and a size of the connected speaker (sound reproduction capacity), suitable for the listening environment.



The speaker configuration includes items for defining a speaker size: Large or Small. Large and Small refer to speakers with woofer diameters 16 cm or larger and smaller than 16 cm, respectively.

#### Extra SP Assign

**Choices:** Zone2/Presence/None\*

Selects the application for EXTRA SP terminals.

**Zone2** Assigns the EXTRA SP terminals for the speakers in the second zone.

**Presence** Assigns the EXTRA SP terminals for the Presence speaker.

**None** Disables the EXTRA SP terminals.

#### Note

When setting “Extra SP Assign” to “Zone2” or “Presence,” the surround back channel signals for main output is separately output from other channels.

## LFE/Bass Out

**Choices:** SWFR/Front/Both\*

Selects speaker(s) for outputting low-frequency components of the LFE (low-frequency effect sound) channel or other channels. The output status is as follows.

### LFE channel signals

Parameter	Subwoofer	Front speakers	Other speakers
Both	Output	Not output	Not output
SWFR	Output	Not output	Not output
Front	Not output	Output	Not output

### Low-frequency components of other channel signals

Parameter	Subwoofer	Front speakers	Other speakers
Both	[1]	[2]	[3]
SWFR	[4]	[3]	[3]
Front	Not output	[1]	[3]

- [1] Outputs low-frequency components of the front left and right channels and the channel of speaker, the size of which is set to "Small."
- [2] Outputs low-frequency components of the front left and right channels.
- [3] Outputs low frequency components when the sizes of speakers are set to "Large."
- [4] Outputs low-frequency components of the channel of speaker, the size of which is set to "Small."

## Front SP

**Choices:** Small/Large\*

Sets the sizes of front left and right speakers.

- Small** Select this when small speakers are connected. Low-frequency components of the front left and right channels are output from a subwoofer.
- Large** Select this when large speakers are connected.

### Note

- When "LFE/Bass Out" is set to "Front," you can only select "Large." If "LFE/Bass Out" is changed to "Front," "Front SP" automatically switches to "Large" even when it is set to "Small."

## Center SP

**Choices:** None/Small\*/Large

Sets the size of center speaker.

- None** Select this when no center speaker is connected. Center channel signals are spread to front left and right speakers.
- Small** Select this when a small center speaker is connected. Low-frequency components of center channel are output from a subwoofer. If a subwoofer is not connected they are output from front speakers.
- Large** Select this when a large center speaker is connected.

## Sur. L/R SP

**Choices:** None/Small\*/Large

Sets sizes of left and right surround speakers.

- None** Select this when no surround speakers are connected. Surround channel signals are spread to front left and right speakers. "Sur.B L/R SP" automatically switches to "None" when this is selected.
- Small** Select this when small surround speakers are connected. Low-frequency components of surround channels are output from a subwoofer. If a subwoofer is not connected they are output from front speakers.
- Large** Select this when large surround speakers are connected.



- When "None" is selected, the sound field programs automatically enter the Virtual CINEMA DSP mode.

## Sur. B L/R SP

**Choices:** None/SMLx1/SMLx2\*/LRGx1/LRGx2

Sets sizes of left and right surround back speakers.

- None** Select this when no surround back speaker are connected. Surround back channel signals are output from the surround L/R speakers and subwoofer. If the subwoofer is disabled, they are output from the surround L/R speakers and front speakers.
- SMLx1** Select this when one small surround back speaker is connected.
- SMLx2** Select this when two small surround back speakers are connected.
- LRGx1** Select this when one large surround back speaker is connected.
- LRGx2** Select this when two large surround back speakers are connected.



- When "None" is selected, "PLIIX Movie" or "PLIIX Music" cannot be selected.



### Crossover Freq.

**Choices:** 40Hz/60Hz/80Hz\*/90Hz/100Hz/110Hz/120Hz/  
160Hz/200Hz

Sets the lower limit of the low frequency component output from a speaker with a size set to "Small (SMLx1/SMLx2)." Sound with a frequency below that limit is output from a subwoofer or front speakers.

If your subwoofer has a volume control or a crossover frequency control, set the volume to half or the crossover frequency at the maximum.

### Subwoofer Phase

**Choices:** Normal\*/Reverse

Sets the phase of your subwoofer if bass sounds are lacking or unclear.

**Normal** Select this not to change the phase of your subwoofer.

**Reverse** Select this to reverse the phase of your subwoofer.

### B)Level

**Adjustable range:** -10.0dB to +10.0dB (0.5 dB step)

**Defaults:** "FR. L/FR. R/SWFR" 0dB\*  
"CNTR/SUR. L/SUR. R/SBL/SBR" -1.0dB

Separately adjusts volume of each speaker so that the sounds from speakers are at the same volume at the listening position. Items to be displayed vary depending on the number of speakers connected.



- When only one surround back speaker is connected, "SB" appears instead of "SBL" and "SBR."
- You can adjust the volume listening to test tones when you set "Test Tone" to "On" (see page 53).
- If your subwoofer has a volume control or a crossover frequency control, set the volume to half or the crossover frequency at the maximum.

### C)Distance

Adjusts timing at which each speaker outputs sound so that sounds from speakers reach the listening position at the same time. Set unit (Unit) first and set the distance of each speaker.

#### Unit

**Choices:** meters (m)/feet (ft)\*

meters (m) Displays the speaker distance in meters.

feet (ft) Displays the speaker distance in feet.

Front L/Front R/Center/Sur. L/  
Sur. R/Sur. B L/Sur. B R/SWFR/PRNS  
L/PRNS R

**Adjustable range:** 0.30m to 24.00m (1.0ft to 80.0ft)

**Defaults:** 3.00m (10.0ft) "Front L/Front R/  
SWFR"  
2.60m (8.5ft) "Center"  
2.40m (8.0ft) "Sur. L/Sur. R/  
Sur. B L/Sur. B R/PRNS L/PRNS R"



- Different items are displayed depending on settings of "A)Config" (see page 51).
- When only one surround back speaker is connected, "Sur.B" appears instead of "Sur.B L" and "Sur.B R."

### D)Equalizer

Adjusts sound quality and tone using a parametric graphic equalizer.

#### EQ Type Select

**Choices:** Auto PEQ/GEQ\*/Off

Select an equalizer type.

**Auto PEQ** Uses a parametric equalizer selected in "Auto Setup." Characteristics of the currently used parametric equalizer (see page 19) are displayed below "Auto PEQ."

**GEQ** Uses a graphic equalizer. Press **[F5]ENTER** to adjust the characteristics of the graphic equalizer.

**Off** Not use a graphic equalizer.

#### GEQ

**Choices:** 63Hz/160Hz/400Hz/1kHz/2.5kHz/  
6.3kHz/16kHz

**Adjustable range:** -6.0dB to 0dB\* to +6.0dB (0.5 dB step)

Adjusts sound quality of each speaker using a graphic equalizer. The graphic equalizer of this unit can adjust signal levels in 7 frequency ranges.

To adjust the signal level within each range, select the desired speaker with **[F5]Cursor </>** while "→" is displayed next to "Channel," then the desired frequency band with **[F5]Cursor Δ / ∇**, and adjust the signal level with **[F5]Cursor </>**.

### E)Test Tone

**Choices:** Off\*/On

Switches between on and off of an oscillator that generates test tones. To turn on the oscillator, select "On" using **[F5]Cursor </>**. When "On" is selected, you can adjust the settings of "2 Manual Setup" while listening to a test tone.

**Off** Not generate test tones.

**On** Generates test tones.

## Sound Setup

You can set various items for sound outputs.

### 1 Dynamic Range

**Choices:** Min/Auto/STD/Max\*

Selects the dynamic range adjustment method for reproducing bitstream signals.

**Min/Auto** (Min) Sets the dynamic range suitable for low volume or a quiet environment, such as at night, for bitstream signals except for Dolby TrueHD signals.

(Auto) Adjusts the dynamic range for Dolby TrueHD signals based on input signal information.

**STD** Sets the standard dynamic range recommended for regular home use.

**Max** Outputs sound without adjusting the dynamic range of the input signals.

## ■ 2 Lipsync

Adjusts delay between video output and audio output.

### HDMI Auto

**Choices:** Off\*/On

Automatically adjusts output timing of audio and video signals when a monitor that supports an automatic lip-sync function is connected to this unit.

**Off** Select this when the connected monitor does not support the automatic lip-sync function or you do not use the automatic lip-sync function. Set the correction time in "Manual Delay."

**On** Select this when the connected monitor supports the automatic lip-sync function. Fine adjust the correction time in "Auto Delay."

### Auto Delay

**Adjustable range:** 0\* to 240ms (1 ms step)

Fine adjust the correction time when "HDMI Auto" is set to "On." The actual correction time is displayed under in "Auto Delay" field and an offset time set by the user in "Offset" field.

### Manual Delay

**Adjustable range:** 0\* to 240ms (1 ms step)

Manually fine adjusts the correction time. Select this when the connected monitor does not support the automatic lip-sync function or you set "HDMI Auto" to "Off."

## Function Setup

You can set various items for HDMI and display.

### 1 HDMI

You can set items for HDMI.

#### ■ Standby Through

**Choices:** On/Off\*

Selects on or off of output of HDMI signals input from the HDMI IN jack to the HDMI OUT jack when this unit is on standby. When this parameter is set to "On" signals input from the HDMI 1-4 jacks can be output to a monitor component.

**On** Outputs the HDMI signals to the HDMI OUT jack.

**Off** Not output the HDMI signals to the HDMI OUT jack.



- To enables pass-through output, any one of the input sources connected to the HDMI1-4 must be selected before switching to standby.
- When Standby Through turns on, the HDMI THROUGH indicator on the front panel display lights up. While the indicator lights up, this unit consumes up to 3W of power even on standby.

## ■ Audio Output

**Choices:** AMP\*/TV/AMP+TV

Selects this unit or a component connected to this unit via the HDMI OUT jack of this unit for reproducing sound signals input from the HDMI IN jack.

**AMP** Outputs HDMI sound signals form the speakers connected to this unit.

**TV** Outputs HDMI sound signals from the speakers of a TV connected to this unit. Sound output from the speakers connected to this unit is muted.

**AMP+TV** Outputs HDMI sound signals from the speakers connected to this unit and the speakers of a TV connected to this unit.

### Note

- Signal formats of audio and visual signals output from this unit to the monitor vary depending on specifications of the monitor.

## ■ Resolution

**Choices:** Thru9h\*/480P/720P/1080i/1080P

Upscales the resolution of HDMI output that is converted from analog video input signals and output from the HDMI OUT jack.

### Notes

- Resolution of the HDMI output converted from 720p or 1080i analog video signals cannot be upscaled.
- When a video monitor is connected to this unit via the HDMI jack, this unit automatically detects a resolution that the monitor supports. An asterisk (\*) appears on the left of the detected resolution.
- If this unit cannot detect the resolution that the monitor supports, set "MON.CHK" in the advanced setup menu to "SKIP" (see page 60) and try it again.

## ■ Aspect

**Choices:** Thrh9h\*/16:9/Smart

Set a horizontal to vertical ratio (aspect ratio) of images reproduced by HDMI signals output from the HDMI OUT jack when the HDMI signals are converted from analog video input signals by a video conversion function.

**Thrh9h** Outputs the video signals without changing the aspect ratio.

**16:9** Outputs the video signals that displays 4:3 images on a 16:9 monitor with black bands on the right and left sides of the monitor screen.

**Smart** Outputs the video signals that displays 4:3 images on a 16:9 monitor by stretching right and left of images to fit on the monitor screen.

### Notes

- You cannot change the aspect ratio of the screen when "Resolution" is set to "Thrh9h."
- The setting is not effective for inputs with the aspect ratio other than 4:3.
- You cannot obtain an effect of the aspect ratio when visual signals are input from the HDMI IN jack or 720p, 1080i or 1080p signals are input.

## 2 Display

You can set items for a monitor or the front panel display.

### ■ Dimmer

**Adjustable range:** -4 to 0\*

Sets brightness of the front panel display. As the value is lowered, the brightness of the front panel display is darkened.

#### Note

- The brightness of display does not become bright in Pure Direct mode even if the value is increased.

### ■ FL Scroll

**Choices:** Continue\*/Once

Selects the way to scroll the screen when a total number of characters exceed a display area of the front panel display.

- Continue** Repeatedly displays all characters by scrolling.
- Once** Displays all characters by scrolling once, halts scrolling, and then displays first 14 characters.

### ■ OSD Shift

**Adjustable range:** -5 to 0\* to +5

Adjusts top and bottom positions of the screen displayed on the video monitor. To move up the screen, set this value larger. To move down the screen, set it smaller.

## 3 Volume

You can set items for volumes.

### ■ Adaptive DRC

**Choices:** Auto/Off\*

Adjust the dynamic range in conjunction with the volume level. This feature is useful when you are listening at lower volumes or at night. When this function is enabled, the dynamic range is adjusted as follows.

If the VOLUME setting is low: the dynamic range is narrow

If the VOLUME setting is high: the dynamic range is wide

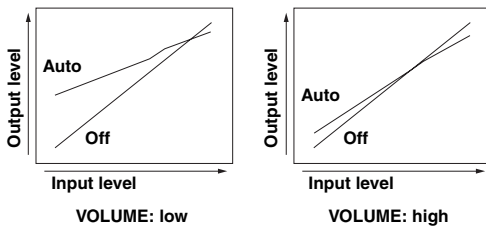

- Auto** Adjusts the dynamic range automatically.
- Off** Not adjust the dynamic range automatically.



- The Adaptive DRC setting is effective for headphones.

### ■ Max Volume

**Adjustable range:** -30.0dB to +15.0dB/+16.5dB\* (5.0 dB step)

Sets the maximum volume level so that the volume will not be accidentally increased. For example, you can adjust the volume between -80.0 dB and -5.0 dB when you set this parameter to “-5.0dB.” The volume increases to the maximum level when this parameter is set to +16.5 dB (default).

### ■ Init. Volume

**Choices:** Off\*/Mute/-80.0dB to +16.5dB (0.5 dB step)

Sets the volume at the time this unit is turned on. When this parameter is set to “Off,” the volume is set to a level that last time this unit is set to standby.

#### Note

- When you set “Max Volume” and “Init. Volume,” the setting of “Max Volume” becomes effective. For example, when you set “Max Volume” to “-30.0dB” and “Init. Volume” to “0.0dB,” the volume is automatically set to “-30.0dB” at the next time this unit is turned on.

## 4 Input Rename

Changes input source names to be displayed on the front panel display.

You can select an input source that you want to change the name to be displayed using **[F5]Cursor**.

### Selecting a name to be displayed from templates

Select an input source that you want to change the name, and select a name from the following templates using **Cursor**.

- Blu-ray
- DVD
- SetTopBox
- Game
- TV
- DVR
- CD
- CD-R
- Satellite
- VCR
- Tape
- MD
- PC
- iPod
- HD DVD
- “blank”

### Entering an original name

Select an input source that you want to name, and press **[F5]ENTER**. You can enter up to 9 characters by selecting one character at a time with the following keys according to the following operation.

- [F5]Cursor** < / > For selecting characters that you want to change
- [F5]Cursor** Δ / ∇ For selecting characters to be entered
- [F5]ENTER** For entering the selected characters

The following characters are available for input.

A to Z, 0 to 9, a to z, symbols (#, \*, -, +, etc.) and space

## 5 Zone2

Sets the maximum volume level and initial volume level of Zone2.



- This item is displayed only when “Extra SP Assign” is set to “Zone2.”

### ■ Max Volume

**Adjustable range:** -30.0dB to +15.0dB / +16.5dB\*  
(5.0 dB step)

Sets the maximum volume level of Zone2, so that the volume will not be accidentally increased. For example, you can adjust the volume between -80.0 dB and -5.0 dB when you set this parameter to “-5.0dB.”

### ■ Init. Volume

**Choices:** Off\*/Mute/-30.0dB to +16.5dB (0.5 dB step)

Use this feature to set the volume level of Zone2 when the power of Zone2 unit is turned on.

#### **Note**

- When you set “Max Volume” and “Init. Volume,” the setting of “Max Volume” becomes effective. For example, when you set “Max Volume” to “-30.0dB” and “Init. Volume” to “0.0dB;” the volume is automatically set to “-30.0dB” at the next time this unit is turned on.

## DSP Parameter

You can set parameters for the sound field programs. For details, see page 46.

## Memory Guard

**Choices:** Off\*/On

Protects settings of setup menu against accidental alteration.

Off	Not protect settings.
On	Protects the settings of the setup menu (except for the Memory Guard setting).

#### **Note**

- When this parameter is switched to “On,” “G” appears while the setup menu is displayed on the video monitor.

# Using multi-zone configuration

This unit allows you to configure a multi-zone audio system. The Zone2 feature allows you to set this unit to reproduce separate input sources in the main zone and the second zone (Zone2). You can control this unit from the second zone using the supplied remote control.

Only analog signal can be sent to Zone2. If you want to output the sound from Zone2, connect an external component to AV5-6 or AUDIO1-2 by analog connection. For example, if you want to output sound from an HDMI DVD player in Zone2, you must connect the component to this unit by both HDMI and analog connections.

## Connecting Zone2

You need the following additional equipment to use the multi-zone functions of this unit:

- An infrared signal receiver in the second zone.
- An infrared signal emitter in the main zone. This emitter transmits infrared signals from the remote control to a CD player or a DVD player, etc. in the main zone via the infrared signal receiver in the second zone.
- An amplifier and speakers in the second zone.



- Since there are many possible ways to connect and use this unit in a multi-zone configuration, we recommend that you consult with your nearest authorized Yamaha dealer or service center about the Zone2 connections that best meet your requirements.
- Some Yamaha models can be directly connected to the REMOTE jacks of this unit. You may not need use an infrared signal emitter for these products. Up to 6 Yamaha components can be connected as shown below.

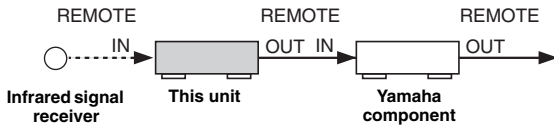

## Note

- To avoid unexpected noise, DO NOT USE the Zone2 feature with CDs encoded in DTS.

## Using the internal amplifier of this unit

### Important safety notice

The EXTRA SP speaker terminals of this unit should not be connected to a Passive Loudspeaker Selector Box or more than one loudspeaker per channel. Connection to a Passive Loudspeaker Selector Box or multiple speakers per channel could create an abnormally low impedance load resulting in amplifier damage. See this owner's manual for correct usage. Compliance with minimum speaker impedance information for all channels must be maintained at all times. This information is found on the back panel of your unit.

Connect the speakers in the second zone to the EXTRA SP terminals and then set the "Extra SP Assign" to "Zone2" (see page 51).

## Using the external amplifier

Connect the amplifier/receiver in the second zone and other components to this unit as follows.

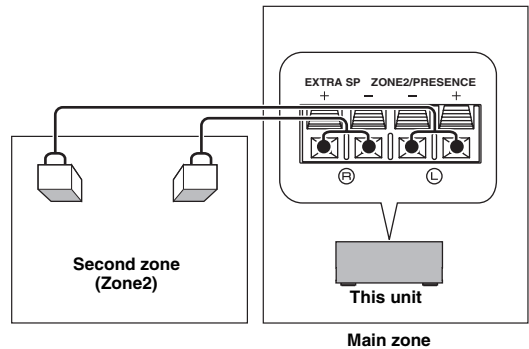
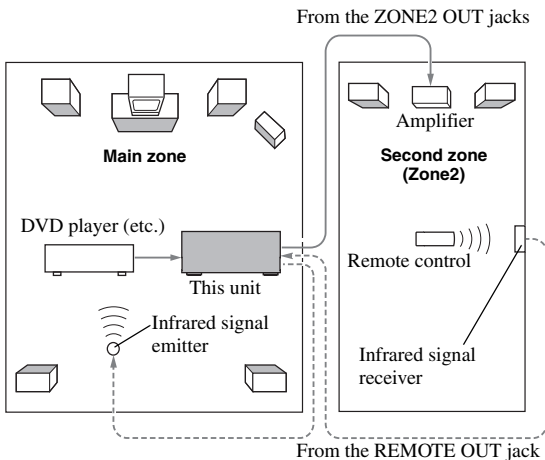

- You can use the speakers connected to EXTRA SP speaker terminals as the front speaker system of another zone. Set "EXTRA SP ASSIGN" to "Zone2" (see page 51).
- When you use the internal amplifiers for the Zone2 speakers, you can adjust the volume level and set the initial volume and maximum volume of the Zone2 speakers (see page 56).

## Controlling Zone2

You can select and control Zone2 by using the control keys on the front panel or on the remote control. The available operations are as follows:

- Selecting the input source (AV5-6, AUDIO1-2, V-AUX) of Zone2.
- Adjusting the volume of Zone2 (when a Zone2 speaker is connected to the EXTRA SP jack).
- Tuning into FM or AM when “TUNER” is selected as the input source of Zone2 (see page 29).
- Tuning into XM Satellite Radio when “XM” is selected as the input source of Zone2 (see page 31) (U.S.A. model only).
- Tuning into SIRIUS Satellite Radio when “SIRIUS” is selected as the input source of Zone2 (see page 35) (U.S.A. model only).
- Playing back music stored on your iPod stationed in a Yamaha iPod universal dock (such as YDS-10 sold separately) connected to the DOCK terminal.

### Note

- You must complete each step while the ZONE2 indicator is flashing on the front panel display. Otherwise, the Zone2 mode is automatically canceled and this unit returns to the normal operation mode. In this case, repeat the Zone2 selection procedure.

## Controlling Zone2 with the front panel

### ■ Turning on Zone2

Press **Ⓞ ZONE2 ON/OFF** to turn on Zone2.

### ■ Activating the Zone2 operation mode

Press **Ⓢ ZONE2 CONTROL** to control Zone2.

The ZONE2 indicator flashes on the front panel display for approximately 10 seconds.

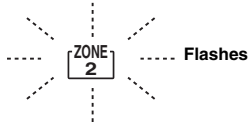

### ■ Operating Zone2

Press **Ⓢ INPUT** **</>** to select the desired input source while the ZONE2 indicator is flashing on the front panel display.

- When AV5-6, AUDIO1-2 or V-AUX is selected, you can listening to the input source in Zone2.
- Select “TUNER” as the input source to use the TUNER features in Zone2. For details about the TUNER operations, see “FM/AM tuning” on page 29.
- Select “XM” as the input source to use the XM Satellite Radio features in Zone2. For details about the XM Satellite Radio operations, see “XM Satellite Radio tuning” on page 31.

- Select “SIRIUS” as the input source to use the SIRIUS Satellite Radio features in Zone2. For details about the SIRIUS Satellite Radio operations, see “SIRIUS Satellite Radio tuning” on page 35.
- Select “DOCK” as the input source to use iPod features in Zone2. For details about the iPod operations, see “Using iPod” on page 40.
- Select “DOCK” as the input source to use Bluetooth component features in Zone2. For details about the Bluetooth component operations, see “Using Bluetooth components” on page 42.

### ■ Set Zone2 to the standby mode

Press **Ⓞ ZONE2 ON/OFF** to set Zone2 to the standby mode.

## Controlling Zone2 with the remote control

### ■ Turning on Zone2

Switches **[2] MAIN/ZONE2** to **ZONE2** position, and press **[7] POWER**.

### ■ Operating Zone2

Switches **[2] MAIN/ZONE2** to **ZONE2** position, and press one of the input selection keys to select the desired input source of Zone2.

### Note

- **[18] MUTE** and **[16] VOLUME +/-** are available to control Zone2 with same procedure as mentioned above.

### ■ Setting Zone2 to the standby mode

Switches **[2] MAIN/ZONE2** to **ZONE2** position, and press **[7] POWER** and to set ZONE2 to the standby mode.

# Controlling other components with the remote control

You can control external components for a selected input source with the remote control. The keys available for controlling external components are as follows:

## 5 SOURCE POWER

Turns on and off an external component.

## 15 Cursor, ENTER, RETURN

Operates the menus of external components.

## 17 DISPLAY

Switches between the screens of external components.

## 19 External component operation keys

Function as a recording or playback key of an external component, or a menu display key.

## 20 Numeric keys

Function as numeric keys of an external component.

## 21 TV control keys

**INPUT** Switches visual inputs of TV

**MUTE** Mute audio of TV

**TV VOL +/-** Controls the volume of TV

**TV CH +/-** Switches channels of TV

**POWER** Turns on and off TV



- You can use **21 TV control keys** only for controls of TV regardless of selected input sources.
- You need to set the remote control code first to control external components.
- The remote control keys for controlling external components are available only when the external components have corresponding control keys.

The following remote control codes are assigned to input sources as factory default settings. For a complete list of available remote control codes, refer to “List of remote control codes” at the end of this manual.

### ■ Default remote control code settings

Input source	Category	Manufacturer	Default code
[HDMI1]	Blu-ray Disc	Yamaha	2018
[HDMI2]	—	—	—
[HDMI3]	—	—	—
[HDMI4]	—	—	—
[AV1]	—	—	—
[AV2]	—	—	—
[AV3]	CD	Yamaha	5013
[AV4]	—	—	—
[AV5]	—	—	—
[AV6]	—	—	—
[AUDIO1]	—	—	—
[AUDIO2]	—	—	—
[V-AUX]	—	—	—
[TUNER]	Tuner	Yamaha	5007

Input source	Category	Manufacturer	Default code
[DOCK]	DOCK	Yamaha	5011
[A]/[B]	—	—	—

“—” indicates no assignment



- An external component that is controlled by the remote control can be automatically selected according to selection of the scenes (see page 22).

## Setting remote control codes

You can control other components by setting the appropriate remote control codes. For a complete list of available remote control codes, refer to “List of remote control codes” at the end of this manual.

- Press **4 CODE SET** on the remote control using a pointed object such as the tip of a ballpoint pen.  
**3 TRANSMIT** on the remote control blinks twice.

- Press **8 Input selection keys**.

- Enter a remote control code using **20 Numeric keys**.  
Once the remote control code is registered, **3 TRANSMIT** on the remote control blinks twice. If it fails, **3 TRANSMIT** blinks six times. Repeat from step 1.

## Resetting all remote control codes

You can clear all the remote control codes previously set, and reset all of them to the initial factory settings.

- Press **4 CODE SET** on the remote control using a pointed object such as a tip of a ballpoint pen.  
**3 TRANSMIT** on the remote control blinks twice.
- Press **13 SETUP** on the remote control.
- Enter “9981” using **20 Numeric keys**.  
Once the initialization is complete, **3 TRANSMIT** on the remote control blinks twice. If it fails, **3 TRANSMIT** blinks six times. Repeat from step 1.

# Advanced setup

In the advanced setup, you can set basic operations of this unit, such as on and off of a bi-amp connection, or initialize user settings. Perform the following steps to change settings.

- 1 Set this unit to the standby mode.**
- 2 Press **Ⓐ**MAIN ZONE ON/OFF while pressing and holding **Ⓜ**STRAIGHT on the front panel.**  
The advanced setup menu appears on the front panel display.



ADVANCED SETUP

- 3 Press **Ⓛ**PROGRAM </> repeatedly to select the parameter you want to change.**

The default setting are marked with “\*.”



- Set values are placed in XXX of the following parameters on an actual display screen.

SP IMP. -XXX

**Choices:** 6ΩMIN/8ΩMIN\*

Selects output impedance of this unit according to connected speakers.

REMOTE ID -XXX

**Choices:** ID1\*/ID2

Sets a remote control ID. When using multiple Yamaha AV receivers, you can operate them with a single remote control by setting the receiver IDs to the same setting.

SR PIN -XXX

**Choices:** RESET/CANCEL

Resets Parental lock cord when using SIRIUS Satellite tuner.

BI AMP - XXX

**Choices:** ON/OFF\*

Switches on and off of bi-amp connection of main speakers. For bi-amp connection, see page 12.

SCENE IR -XXX

**Choices:** ON\*/OFF

Selects whether or not to transmit the control signals to an external component connected to the REMOTE jacks on this unit when BD/DVD or CD SCENE function is selected.

MON. CHK - XXXX

**Choices:** YES\*/SKIP

Adds upscaling limitation on output signals to a video monitor connected to this unit via the HDMI OUT jack.

INIT-XXXXXXXXXX

**Choices:** DSP PARAM/VIDEO/ALL/CANCEL

Initializes various settings stored in this unit. You can select an initialization method from the following.

DSP PARAM: All parameters of sound field programs

VIDEO: Video conversion settings (resolution/aspect) in the setup menu and the OSD display position

ALL: Reset this unit to initial factory settings

CANCEL: Cancellation of initialization

- 4 Press **Ⓜ**STRAIGHT a few times to select the value you want to change.**

The value selected here becomes effective when this unit is turned on the next time. You can change multiple settings by repeating steps 3 and 4.

- 5 Press **Ⓐ**MAIN ZONE ON/OFF, turns off this system, and press **Ⓐ**MAIN ZONE ON/OFF again.**

The value set in step 3 becomes effective, and this unit turns on. When you select initialization in step 3, the initialization is performed.

## Setting a remote control ID

Two IDs are provided for the remote control of this unit. If another Yamaha amplifier is in the same room, setting a different remote control ID to this unit prevents unwanted operation of the other amplifier.

ID1 is set for both remote control and amplifier by default. When you change the remote control ID, display “Advance Setup” (see the previous section) and change the ID for the amplifier too.

- 1 Press **4**CODE SET on the remote control using a pointed object such as the tip of a ballpoint pen.**

**3**TRANSMIT blinks twice.

- 2 Press **13**SETUP on the remote control.**

- 3 Enter the desired remote control ID code.**

To switch to ID1:

Enter “5019” using **20**Numeric keys.

To switch to ID2:

Enter “5020” using **20**Numeric keys.

Once the remote control code is registered,

**3**TRANSMIT blinks twice.

If it fails, **3**TRANSMIT blinks six times. Repeat from step 1.



- Initializing the remote control code (see page 59) returns it to ID1.



# APPENDIX

## Troubleshooting

Refer to the table below when this unit does not function properly. If the problem you are experiencing is not listed below or if the instruction below does not help, turn off this unit, disconnect the power cable, and contact the nearest authorized Yamaha dealer or service center.

### General

Problem	Cause	Remedy	See page
<b>This unit fails to turn on or enters the standby mode soon after the power is turned on.</b>	The power cable is not connected or the plug is not completely inserted.	Connect the power cable properly to an AC wall outlet.	—
	The speaker impedance setting is incorrect.	Set the speaker impedance to match your speakers.	60
	(When this unit is turned back on and “CHECK SP WIRES!” is displayed.) The protection circuitry has been activated because this unit was turned on while a speaker cable was shorted.	Make sure that all speaker cables between this unit and speakers are connected properly.	11
<b>This unit cannot be turned off.</b>	The internal microcomputer is frozen due to an external electric shock (such as lightning or excessive static electricity) or by a drop in power supply voltage.	Disconnect the power cable from the AC wall outlet, wait about 30 seconds and then plug it in again.	—
<b>No sound.</b>	“Audio Output” in “1 HDMI” Function Setup is set to “TV.”	Select a choice for “Audio Output” (Function Setup → 1 HDMI → Audio Output) other than “TV.”	54
	A proper audio decoder is not selected.	Display the OPTION menu and set “Decoder Mode” to “Auto.”	44
	Incorrect input or output cable connections.	Connect the cables properly. If the problem persists, the cables may be defective.	14-17
	No appropriate input source has been selected.	Select an appropriate input source with <b>Ⓢ</b> INPUT < / > or the <b>Ⓢ</b> Input selector keys on the remote control.	22
	Speaker connections are not secure.	Secure the connections.	11
	The volume is turned down or muted.	Turn up the volume.	—
	Signals this unit cannot reproduce are being input from a source component, such as a CD-ROM.	Display Signal info of the option menu and check the input signal format. If “No Signal” is displayed, check if the playback component is properly connected to this unit (or a proper input source is selected). If “___” is displayed, the input signal in that format cannot be reproduced by this unit.	—
	The HDMI components connected to this unit do not support the HDCP copy protection standards.	Connect HDMI components that support the HDCP copy protection standards.	74

<b>Problem</b>	<b>Cause</b>	<b>Remedy</b>	<b>See page</b>
<b>No picture.</b>	An appropriate video input is not selected on the monitor.	Select an appropriate video input on the monitor.	—
	The composite output terminals are used to output a component video signal, or the COMPONENT VIDEO jacks are used to output a composite video signal.	If your monitor does not support the HDMI connection, connect it to the COMPONENT OUT jacks or the composite output terminals and select an appropriate video input on the monitor.	14
	This unit outputs the video signals are not supported on the video monitor connected to the HDMI OUT jack.	Displays the advanced setup menu and select “VIDEO” in “INIT” to reset the video parameters.	60
		Displays the advanced setup menu and set “MON.CHK” to “YES.”	60
	Non-standard video signals are input.	Connect the monitor to this unit via the COMPONENT OUT jacks or the composite output terminals.	14
<b>The sound suddenly goes off.</b>	The protection circuitry has been activated because of a short circuit, etc.	Check that the speaker impedance setting is correct.	60
		Check that the speaker wires are not touching each other and then turn this unit back on.	—
	The sleep timer has turned off this unit.	Turn on this unit, and play the source again.	—
<b>Sound is heard from the speaker on one side only.</b>	The playback component or speakers are not connected properly.	Connect the cables properly. If the problem persists, the cables may be defective.	11
	The speaker level settings are incorrect.	Adjust “B)Level” settings.	53
<b>Only the center speaker outputs substantial sound.</b>	When a monaural source sound field program is applied, sound of all channels are output from the center speaker for some surround decoders.	Try another sound field program.	25
<b>No sound is output from a specific speaker.</b>	Output from that speaker is disabled.	Check the Speaker indicators on the front panel display. If the corresponding indicator is turned off, try the following. 1) Change the input source to another one. 2) With the selected sound field program, sound is not output from that speaker. Select another sound field program. 3) “None” may have been selected for that speaker on this unit. Display Speaker Setup in the Setup menu and enables output of that speaker.	6, 22, 25, 52
		The volume of that speaker is set to minimum in Speaker Setup in the Setup menu.	Display Speaker Setup in the Setup menu and adjust the volume (Manual Setup → B)Level).
	This unit or speaker is malfunction.	Check the Speaker indicators on the front panel display. If the corresponding indicator lights up, connect another speaker and check if sound is output. If sound is not output, this unit may be malfunction.	6, 10
<b>No sound is heard from the presence speakers.</b>	This unit is in the “STRAIGHT” mode.	Press <b>Ⓜ</b> STRAIGHT or the <b>Ⓜ</b> STRAIGHT on the remote control to turn off the “STRAIGHT” mode.	28
	Sound may not be output from certain channels depending on the input source or sound field program.	Try another sound field program.	25

Problem	Cause	Remedy	See page
<b>No sound is heard from the surround speakers.</b>	This unit is in the “STRAIGHT” mode and a monaural source is being played back.	Press <b>Ⓜ</b> STRAIGHT or the <b>Ⓜ</b> STRAIGHT on the remote control to turn off the “STRAIGHT” mode.	28
	Sound may not be output from certain channels depending on input sources or sound field programs.	Try another sound field program.	25
<b>No sound is heard from the subwoofer.</b>	“LFE/Bass Out” of “A)Config” in “Speaker Setup” of the setup menu (Speaker Setup→Manual Setup→A)Config) is set to “Front” when a Dolby Digital, DTS or AAC signal is being played.	Set “LFE/Bass Out” to “SWFR” or “Both.”	52
	“LFE/Bass Out” of “A)Config” in “Speaker Setup” of the setup menu (Speaker Setup→Manual Setup→A)Config) is set to “SWFR” or “Front” when a 2-channel source is being played.	Set “LFE/Bass Out” to “Both.”	52
	The source does not contain low frequency signals.		
<b>No sound is heard from the surround back speakers.</b>	“Extended Surround” in the OPTION menu is set to “Off,” or an input signal does not contain a surround back flag with “Extended Surround” set to “Auto.”	Set “Extended Surround” other than “Off” or “Auto.”	44
<b>The audio input sources cannot be played in the desired digital audio signal format.</b>	The connected component is not set to output the desired digital audio signals.	Set the playback component properly referring to its operating instructions.	—
<b>Noise/hum noise is heard.</b>	Incorrect cable connection.	Connect the audio cables properly. If the problem persists, the cables may be defective.	—
	A DTS-CD is being played back.	1) When only noise is output If a DTS bitstream signal is not properly input to this unit, only noise is output. Connect the playback component to this unit by digital connection and play back the DTS-CD. If the condition is not improved, the problem may results from the playback component. Consult the manufacturer of the playback component. 2) When noise is output during playback or skip operation Before playing back the DTS-CD, display the option menu after selecting the input source and set “Decoder Mode” to “DTS.”	15, 44
<b>“Memory Guard!” is displayed and the setting cannot be changed.</b>	“Memory Guard” in “Set Menu” is set to “On.”	Set “Memory Guard” to “Off.”	56
<b>This unit does not operate properly.</b>	The internal microcomputer is frozen due to an external electric shock (such as lightning or excessive static electricity) or by a drop in power supply voltage.	Disconnect the power cable from the AC wall outlet, wait about 30 seconds and then plug it in again.	—

Problem	Cause	Remedy	See page
<b>“CHECK SP WIRES!” appears on the front panel display.</b>	Speaker cables are short-circuited.	Make sure all speaker cables are connected correctly.	12
<b>There is noise interference from digital or radio frequency equipment.</b>	This unit is too close to other digital or radio frequency equipment.	Move this unit further away from such equipment.	—
<b>The picture is disturbed.</b>	The video software is copy-protected.		
<b>This unit suddenly enters the standby mode.</b>	The internal temperature becomes too high and the overheat protection circuitry has been activated.	Wait about 1 hour for this unit to cool down and then turn it back on.	—

## HDMI

Problem	Cause	Remedy	See page
<b>No picture or sound.</b>	The number of the connected HDMI components is over the limit.	Disconnect some of the HDMI components.	—
	The connected HDMI component does not support high-bandwidth digital copyright protection (HDCP).	Connect an HDMI component that supports HDCP.	15

## Tuner (FM/AM)

Problem	Cause	Remedy	See page
<b>FM</b>	You are too far from the station transmitter or the input from the antenna is weak.	Check the antenna connections.	18
		Replace the outdoor antenna with a more sensitive multi-element antenna.	—
		Switch to monaural mode.	44
<b>There is distortion, and clear reception cannot be obtained even with a good FM antenna.</b>	There is multi-path interference.	Adjust the antenna height or orientation, or place it in a different location.	—
<b>The desired station cannot be tuned into with the automatic tuning method.</b>	You are in an area far from a station or an input from the antenna is weak.	Replace an outdoor antenna with more sensitive multi element antenna.	—
		Tune in manually or by direct frequency tuning.	29

	Problem	Cause	Remedy	See page
AM	<b>The desired station cannot be tuned into with the automatic tuning method.</b>	The signal is weak or the antenna connections are loose.	Adjust the AM loop antenna orientation.	18
			Use the manual tuning method.	29
	<b>There are continuous crackling and hissing noises.</b>	Supplied AM loop antenna is not connected.  The noises may be caused by lightning, fluorescent lamps, motors, thermostats and other electrical equipment.	Connect the AM loop antenna correctly even if you use an outdoor antenna.	18
			It is difficult to completely eliminate noise, but it can be reduced by installing and properly grounding an outdoor AM antenna.	18
<b>There are buzzing and whining noises.</b>	A TV set is being used nearby.	Move this unit away from the TV set.	—	

### XM Satellite Radio (U.S.A. model only)

If an operation takes longer than usual or an error occurs, one of the following messages may appear on the front panel display. In this case, read the cause and follow the corresponding remedies.

	Status message	Cause	Remedy	See page
	CHECK XM TUNER	The XM Mini-Tuner is not installed in the XM Mini-Tuner Home Dock or the XM Mini-Tuner Home Dock is not connected to this unit.	Confirm the XM Mini-Tuner is fully seated in the dock and check the XM Mini-Tuner Home Dock cable is connected to this unit.	31
	CHECK ANTENNA	The XM antenna is not connected to the XM Mini-Tuner Home Dock or the XM antenna cable has become damaged.	Check that the XM antenna is securely connected to the XM Mini-Tuner Home Dock and check the antenna cable for damage. Replace the XM antenna if the cable is damaged.	31
	LOADING XM	The XM Mini-Tuner is acquiring audio or program information from the XM satellite signal. This message can also occur in weak XM signal conditions. Note that this unit may not respond to some operations while this message is displayed.	This message should disappear in a few seconds in good signal conditions. If you see this message often, reposition the XM antenna to get better signal reception. Use the “ANTENNA INFO” information on the front panel display or “XM Information” screen in the video monitor to check the antenna reception level.	34
	NO SIGNAL	The XM Mini-Tuner is not receiving the XM satellite signal. Something may be blocking the XM antenna’s view of the satellites or the antenna is not properly aimed.	Check for antenna obstructions and reposition the XM antenna to get better signal reception. Use the “ANTENNA INFO” information on the front panel display or “XM Information” screen in the video monitor to check the antenna reception level. See instructions supplied with the XM Mini-Tuner and Dock for antenna installation information.	34
	CH OFF AIR	The XM channel you selected is not currently broadcasting.	Check back at a later time; in the meantime, select another channel.	—
	CH UNAUTH	You may be attempting to tune to an XM channel that is blocked or that you cannot receive with your XM subscription package.	Consult the latest channel guide at <a href="http://www.xmradio.com/">http://www.xmradio.com/</a> for the current list of channels. For information on receiving this channel, visit <a href="http://www.xmradio.com/">http://www.xmradio.com/</a> or contact XM Satellite Radio at 1-800-967-2346.	31

Status message	Cause	Remedy	See page
CH UNAVAIL	The selected channel is not available. The channel may have been reassigned to a different channel number. This message may occur initially with a new XM Mini-Tuner or an XM Mini-Tuner that has not received XM's signal for an extended period.	Consult the latest channel guide at <a href="http://www.xmradio.com/">http://www.xmradio.com/</a> for the current list of channels. For cases of a new XM Mini-Tuner or an XM Mini-Tuner that has not received XM's signal for an extended period, allow the XM Mini-Tuner to receive the XM satellite signal for at least 5 minutes and then try to select the channel again.	—
UPGRADE XM TUNER	This unit has detected a XM CNP1000 which is not compatible with this unit.	If you have connected the XM Mini-Tuner (CNP2000) and see this message, set this unit to standby, disconnect and reconnect the XM Mini-Tuner Home Dock and re-install the Mini-Tuner in the Home Dock and turn on this unit. If you continue to see this message with the XM Mini-Tuner, contact XM Satellite Radio at <a href="http://xmradio.com/">http://xmradio.com/</a> or 1-800-XMRADIO (1-800-967-2346). If you have an incompatible XM CNP1000, contact XM for information on upgrading to the XM Mini-Tuner.	—
- - - -	No artist name or song title is available for this selection.	No action required.	—

### **SIRIUS Satellite Radio (U.S.A. model only)**

If an operation takes longer than usual or an error occurs, one of the following messages may appear on the front panel display. In this case, read the cause and follow the corresponding remedies.

Status message	Cause	Remedy	See page
ANTENNA ERROR	The antenna is not connected to the SiriusConnect tuner properly.	Check the connection of the antenna and SiriusConnect tuner.	35
SIRIUS LOADING	This unit is communicating with the SiriusConnect tuner.	The message disappears normally within several tens of seconds.	—
CHECK SR TUNER	The SiriusConnect tuner is not connected to the SIRIUS jack of this unit correctly.	Check the connection of the SiriusConnect tuner and this unit.	35
	The SiriusConnect tuner is not connected to the AC wall outlet.	Connect the power cable of the SiriusConnect tuner to the AC wall outlet.	35
NOT SUPPORTED	This unit does not support the connected SIRIUS Satellite Radio tuner.	Connect the SiriusConnect tuner that this unit supports,	35
ACQUIRING	The signal is too weak.	Adjust the orientation of the antenna of the SiriusConnect tuner. Use the "Antenna" information on the front panel display or "SIRIUS Information" screen in the video monitor to check the antenna reception level.	39
UPDATING	The SiriusConnect tuner is updating the channel list.	Wait until the updating is complete.	—
	The period of the subscription is end.	Contact SIRIUS Satellite Radio to renew the subscription.	35
F/W UPDATING	The SiriusConnect tuner is updating the firmware.	Wait until the updating is complete.	—

Status message	Cause	Remedy	See page
CALL SIRIUS (CALL 888-539- SIRIUS TO SUBSCRIBE)	The selected channel is not subscribed.	Contact SIRIUS Satellite Radio to subscribe the selected channel. URL: <a href="https://activate.siriusradio.com/">https://activate.siriusradio.com/</a> Phone: 1-888-539-SIRIUS (1-888-539-7474)	35
		Select another channel.	35
SUB UPDATED	The subscription information is updated.		
INVALID	The selected channel is currently out of service.	Select another channel.	35
Not Available	The operation you made is not available.		

## Remote control

Problem	Cause	Remedy	See page
<b>The remote control does not work or function properly.</b>	Wrong distance or angle.	The remote control will function within a maximum range of 6 m (20 ft) and no more than 30 degrees offaxis from the front panel.	9
	Direct sunlight or lighting (from an inverter type of fluorescent lamp, strobe light, etc.) is striking the remote control sensor of this unit.	Adjust the lighting angle or reposition this unit.	—
	The batteries are weak.	Replace all batteries.	9
	The remote control ID of the remote control and this unit do not match.	Match the remote control ID of this unit and the remote control.	60
	The remote control code is not correctly set.	Set the remote control code correctly using “List of remote control codes” at the end of this manual.	59
		Try setting another code of the same manufacturer using “List of remote control codes” at the end of this manual.	59
		If this unit does not work when you press <b>15</b> <b>Cursor</b> , do the following. When the key does not work during DVD disc menu operation: press the <b>8</b> <b>Input selection keys</b> on the remote control again. When the key does not work during OPTION menu/ SETUP menu operation: press the key applicable for the current menu operation again.	—
	Even if the remote control code is correctly set, there are some models that do not respond to the remote control.		

## iPod™

### Note

- In case of a transmission error without a status message appearing on the front panel display and on the OSD, check the connection of your iPod (see page 17).

Problem	Cause	Remedy	See page
Loading...	<p>This unit is in the middle of recognizing the connection with your iPod.</p> <p>This unit is in the middle of acquiring song lists from your iPod.</p>		
Connect error	There is a problem with the signal path from your iPod to this unit.	<p>Turn off this unit and reconnect the Yamaha iPod universal dock to the DOCK terminal of this unit.</p> <p>Remove your iPod in the Yamaha iPod universal dock and then place it back in the dock.</p>	<p>17</p> <p>17</p>
Unknown iPod	The iPod being used is not supported by this unit.	This unit supports iPod (Click Wheel), iPod nano and iPod mini.	—
iPod Connected	Your iPod is properly placed in the Yamaha iPod universal dock.		
Disconnected	Your iPod is removed from the Yamaha iPod universal dock.	Place your iPod in the Yamaha iPod universal dock.	17
Unable to Play	This unit cannot play back the songs currently stored on your iPod.	<p>Check that the songs currently stored on your iPod are playable.</p> <p>Store some other playable music files on your iPod.</p>	<p>—</p> <p>—</p>

## Bluetooth™

Problem	Cause	Remedy	See page
Searching...	<p>The Bluetooth wireless audio receiver and the Bluetooth component are in the middle of the pairing.</p> <p>The Bluetooth wireless audio receiver and the Bluetooth component are in the middle of establishing the connection.</p>		
Completed	The pairing is completed.		
Canceled	The pairing is canceled.		
BT Connected	The connection between the Yamaha Bluetooth wireless audio receiver and the Bluetooth component is established.		
Disconnected	The Bluetooth component is disconnected from the Yamaha Bluetooth wireless audio receiver.		



## Auto Setup (YPAO)

### Notes

- If the “ERROR” or “WARNING” screen appears, resolve the problem and then run “Auto Setup” again.
- Warning message “W-2” or “W-3” indicates that the adjusted settings may not be optimal.
- Depending on the speakers, warning message “W-1” may appear even if the speaker connections are correct.
- If error message “E-10” occurs repeatedly, contact a qualified Yamaha service center.

### Before Auto Setup

Error message	Cause	Remedy	See page
Connect MIC!	Optimizer microphone is not connected.	Connect the supplied optimizer microphone to the OPTIMIZER MIC jack on the front panel.	19
Unplug HP!	Headphones are connected.	Unplug the headphones.	—
Memory Guard!	The parameters of this unit are protected.	Set “Memory Guard” to “Off.”	56

### During Auto Setup

Error message	Cause	Remedy	See page
E-1:NO FRONT SP	Front L/R channel signals are not detected.	Check the front L/R speaker connections.	11
E-2:NO SUR. SP	Only a signal from one of the surround channels are detected.	Check the surround L/R speaker connections.	11
E-3:NO PRNS SP	Only signals from one of the presence L/R channels are detected.	Check the presence L/R speaker connections.	11
E-4:SBR->SBL	Only right surround back channel signal is detected.	If you connect only one surround back speaker, connect it to the L-side (SINGLE) terminal.	11
E-5:NOISY	Measurement cannot be performed accurately due to loud ambient noise.	Try running “Auto Setup” in a quiet environment.	—
		Turn off noisy electric equipment like air conditioners or move them away from the optimizer microphone.	—
E-6:CHECK SUR.	Surround back speakers are connected, though surround L/R speakers are not.	When using surround back speakers, you need to connect surround L/R speakers.	11
E-7:NO MIC	The optimizer microphone was unplugged during the “Auto Setup” procedure.	Do not touch the optimizer microphone during “Auto Setup.”	19
E-8:NO SIGNAL	The optimizer microphone does not detect test tones.	Check whether the microphone is properly placed.	19
		Check whether the speakers are properly placed and connected.	11
		The optimizer microphone or OPTIMIZER MIC jack may be defective. Contact the nearest Yamaha dealer or service center.	19
E-9:USER CANCEL	“Auto Setup” was cancelled due to an inappropriate user operation.	Run “Auto Setup” again.	19
E-10:INTERNAL ERROR	An internal error occurred.	Run “Auto Setup” again.	19

## After Auto Setup

Error message	Cause	Remedy	See page
W-1: OUT OF PHASE	Speaker polarity is not correct. This message may appear depending on the speakers even when the speakers are connected correctly.	Check the polarities (+, -) of the displayed speaker. If they are correct, the speakers work properly even when this message is displayed.	11
W-2: OVER 24m (80ft.)	The distance between the speaker and the listening position is over 24 m (80 ft).	Bring the speaker within 24 m (80 ft.) area around the listening position.	—
W-3: LEVEL ERROR	The difference of volume level among speakers is excessive.	Recheck the speaker positions and make sure all speakers are placed in a similar environment.	—
		Check the polarities (+, -) of the speakers.	11
		We recommended that you use speakers with the same or similar specifications.	—
		Adjust the output volume of the subwoofer.	—
W-4: CHECK PRNS	Presence speakers were not detected during measurement with “Extra SP Assign” set to “Presence.”	Check the presence speaker connections and perform measurement again. If presence speakers are not connected, set the “Extra SP Assign” to other than “Presence.”	51
		If presence speakers are connected, set the “Extra SP Assign” to “Presence,” and retry Auto Setup.	51

## ■ Audio and video synchronization (lip sync)

Lip sync, an abbreviation for lip synchronization, is a technical term that involves both a problem and a capability of maintaining audio and video signals synchronized during post-production and transmission. Whereas the audio and video latency requires complex end-user adjustments, HDMI version 1.3 incorporates an automatic audio and video syncing capability that allows devices to perform this synchronization automatically and accurately without user interaction.

## ■ Bi-amplification connection

A bi-amplification connection uses two amplifiers for a speaker. One amplifier is connected to the woofer section of a loudspeaker while the other is connected to the combined mid and tweeter section. With this arrangement each amplifier operates over a restricted frequency range. This restricted range presents each amplifier with a much simpler job and each amplifier is less likely to influence the sound in some way.

## ■ Component video signal

With the component video signal system, the video signal is separated into the Y signal for the luminance and the PB and PR signals for the chrominance. Color can be reproduced more faithfully with this system because each of these signals is independent. The component signal is also called the “color difference signal” because the luminance signal is subtracted from the color signal. A monitor with component input jacks is required in order to output component signals.

## ■ Composite video signal

With the composite video signal system, the video signal is composed of three basic elements of a video picture: color, brightness and synchronization data. A composite video jack on a video component transmits these three elements combined.

## ■ Deep Color

Deep Color refers to the use of various color depths in displays, up from the 24-bit depths in previous versions of the HDMI specification. This extra bit depth allows HDTVs and other displays go from millions of colors to billions of colors and eliminate on-screen color banding for smooth tonal transitions and subtle gradations between colors. The increased contrast ratio can represent many times more shades of gray between black and white. Also Deep Color increases the number of available colors within the boundaries defined by the RGB or YCbCr color space.

## ■ Dolby Digital

Dolby Digital is a digital surround sound system that gives you completely independent multi-channel audio. With 3 front channels (front L/R and center), and 2 surround stereo channels, Dolby Digital provides 5 full-range audio channels. With an additional channel especially for bass effects, called LFE (Low Frequency Effect), the system has a total of 5.1-channels (LFE is counted as 0.1 channel). By using 2-channel stereo for the surround speakers, more accurate moving sound effects and surround sound environment are possible than with Dolby Surround. The wide dynamic range from maximum to minimum volume reproduced by the 5 full-range channels and the precise sound orientation generated using digital sound processing provide listeners with unprecedented excitement and realism. With this unit, any sound environment from monaural up to a 5.1-channel configuration can be freely selected for your enjoyment.

## ■ Dolby Digital Surround EX

Dolby Digital EX creates 6 full-bandwidth output channels from 5.1-channel sources.

For the best results, Dolby Digital EX should be used with movie sound tracks recorded with Dolby Digital Surround EX. With this additional channel, you can experience more dynamic and realistic moving sound especially with scenes with “fly-over” and “fly-around” effects.

## ■ Dolby Digital Plus

Dolby Digital Plus is an advanced audio technology developed for high-definition programming and media including HD broadcasts, and Blu-ray Disc. Selected as an optional audio standard for Blu-ray Disc, this technology delivers multichannel sound with discrete channel output. Supporting bitrates up to 6.0 Mbps, Dolby Digital Plus can carry up to 7.1 discrete audio channels simultaneously. Supported by HDMI version 1.3 and designed for the optical disc players and AV receivers/amplifiers of the future, Dolby Digital Plus also remains fully compatible with the existing multichannel audio systems that incorporate Dolby Digital.

## ■ Dolby Pro Logic II

Dolby Pro Logic II is an improved technique used to decode vast numbers of existing Dolby Surround sources. This new technology enables a discrete 5-channel playback with 2 front left and right channels, 1 center channel, and 2 surround left and right channels instead of only 1 surround channel for conventional Pro Logic technology. There are three modes available: “Music mode” for music sources, “Movie mode” for movie sources and “Game mode” for game sources.

## ■ Dolby Pro Logic IIx

Dolby Pro Logic IIx is a new technology enabling discrete multichannel playback from 2-channel or multi-channel sources. There are three modes available: “Music mode” for music sources, “Movie mode” for movie sources (for 2-channel sources only) and “Game mode” for game sources.

## ■ Dolby Surround

Dolby Surround is widely used with nearly all video tapes and laser discs, and in many TV and cable broadcasts as well. Dolby Surround uses a 4-channel analog recording system to reproduce realistic and dynamic sound effects: 2 front left and right channels (stereo), a center channel for dialog (monaural), and a surround channel for special sound effects (monaural). The surround channel reproduces sound within a narrow frequency range. The Dolby Pro Logic decoder built into this unit employs a digital signal processing system that automatically stabilizes the volume on each channel to enhance moving sound effects and directionality.

## ■ Dolby TrueHD

Dolby TrueHD is an advanced lossless audio technology developed for high-definition disc-based media including Blu-ray Disc. Selected as an optional audio standard for Blu-ray Disc, this technology delivers sound that is bit-for-bit identical to the studio master, offering a high-definition home theater experience. Supporting bitrates up to 18.0 Mbps, Dolby TrueHD can carry up to 8 discrete channels of 24-bit/96 kHz audio simultaneously. Dolby TrueHD also remains fully compatible with the existing multichannel audio systems and retains the metadata capability of Dolby Digital, allowing dialog normalization and dynamic range control.

## ■ DSD

Direct Stream Digital (DSD) technology stores audio signals on digital storage media, such as Super Audio CDs. Using DSD, signals are stored as single bit values at a high-frequency sampling rate of 2.8224 MHz, while noise shaping and oversampling are used to reduce distortion, a common occurrence with very high quantization of audio signals. Due to the high sampling rate, better audio quality can be achieved than that offered by the PCM format used for normal audio CDs. The frequency is equal to or higher than 100 kHz and the dynamic range is 120 dB. This unit can transmit or receive DSD signals via the HDMI jack.

## ■ DTS 96/24

DTS 96/24 offers an unprecedented level of audio quality for multi-channel sound on DVD video, and is fully backward-compatible with all DTS decoders. “96” refers to a 96 kHz sampling rate compared to the typical 48 kHz sampling rate. “24” refers to 24-bit word length. DTS 96/24 offers sound quality transparent to the original 96/24 master, and 96/24 5.1-channel sound with full-quality full-motion video for music programs and motion picture soundtracks on DVD video.

## ■ DTS Digital Surround

DTS digital surround was developed to replace the analog soundtracks of movies with a 5.1-channel digital sound track, and is now rapidly gaining popularity in movie theaters around the world. DTS, Inc. has developed a home theater system so that you can enjoy the depth of sound and natural spatial representation of DTS digital surround in your home. This system produces practically distortion-free 6-channel sound (technically, front left and right, center, surround left and right, and LFE 0.1 (subwoofer) channels for a total of 5.1 channels). This unit incorporates a DTS-ES decoder that enables 6.1-channel reproduction by adding the surround back channel to the existing 5.1-channel format.

## ■ DTS Express

This is an audio format for next-generation optical discs such as Blu-ray discs. It uses optimized low bit rate signals for network streaming. In the case of a Blu-ray disc, this format is used with secondary audio, enabling you to enjoy the commentary of the movie producer via the Internet while playing the main program.

## ■ DTS-HD High Resolution Audio

DTS-HD High Resolution Audio is a high resolution audio technology developed for high-definition disc-based media including Blu-ray Disc. Selected as an optional audio standard for Blu-ray Disc, this technology delivers sound that is virtually indistinguishable from the original, offering a high-definition home theater experience. Supporting bitrates up to 6.0 Mbps for Blu-ray Disc, DTS-HD High Resolution Audio can carry up to 7.1 discrete channels of 24-bit/96 kHz audio simultaneously.

DTS-HD High Resolution Audio also remains fully compatible with the existing multichannel audio systems that incorporate DTS Digital Surround.

## ■ DTS-HD Master Audio

DTS-HD Master Audio is an advanced lossless audio technology developed for high-definition disc-based media including Blu-ray Disc. Selected as an optional audio standard for Blu-ray Disc, this technology delivers sound that is bit-for-bit identical to the studio master, offering a high-definition home theater experience. Supporting bitrates up to 24.5 Mbps for Blu-ray Disc, DTS-HD Master Audio can carry up to 7.1 discrete channels of 24-bit/96 kHz audio simultaneously. Supported by HDMI version 1.3 and designed for the optical disc players and AV receivers/amplifiers of the future, DTS-HD Master Audio also remains fully compatible with the existing multichannel audio systems that incorporate DTS Digital Surround.

## ■ HDMI

HDMI (High-Definition Multimedia Interface) is the first industry-supported, uncompressed, all-digital audio/video interface. Providing an interface between any source (such as a set-top box or AV receiver) and an audio/video monitor (such as a digital television), HDMI supports standard, enhanced or high-definition video as well as multi-channel digital audio using a single cable. HDMI transmits all ATSC HDTV standards and supports 8-channel digital audio, with bandwidth to spare to accommodate future enhancements and requirements.

When used in combination with HDCP (High-bandwidth Digital Content Protection), HDMI provides a secure audio/video interface that meets the security requirements of content providers and system operators. For further information on HDMI, visit the HDMI website at “<http://www.hdmi.org/>”

## ■ LFE 0.1 channel

This channel reproduces low-frequency signals. The frequency range of this channel is from 20 Hz to 120 Hz. This channel is counted as 0.1 because it only enforces a low-frequency range compared to the full-range reproduced by the other 5/6 channels in Dolby Digital or DTS 5.1/6.1-channel systems.

## ■ Neural Surround

Neural Surround represents the latest advancement in surround technology and has been adopted by XM Satellite Radio for digital broadcast of surround recordings and live events in surround sound. Neural Surround employs psychoacoustic frequency domain processing which allows delivery of a more detailed sound stage with superior channel separation and localization of audio elements. System playback is scalable from 5.1 to 7.1 multi-channel surround playback.

## ■ Neo:6

Neo:6 decodes the conventional 2-channel sources for 6-channel playback by the specific decoder. It enables playback with the full-range channels with higher separation just like digital discrete signal playback. There are two modes available: “Music mode” for music sources and “Cinema mode” for movie sources.

## ■ PCM (Linear PCM)

Linear PCM is a signal format under which an analog audio signal is digitized, recorded and transmitted without using any compression. This is used as a method of recording CDs and DVD audio. The PCM system uses a technique for sampling the size of the analog signal per very small unit of time. Standing for “Pulse Code Modulation,” the analog signal is encoded as pulses and then modulated for recording.

## ■ Sampling frequency and number of quantized bits

When digitizing an analog audio signal, the number of times the signal is sampled per second is called the sampling frequency, while the degree of fineness when converting the sound level into a numeric value is called the number of quantized bits. The range of rates that can be played back is determined based on the sampling rate, while the dynamic range representing the sound level difference is determined by the number of quantized bits. In principle, the higher the sampling frequency, the wider the range of frequencies that can be played back, and the higher the number of quantized bits, the more finely the sound level can be reproduced.

## ■ “x.v.Color”

A color space standard supported by HDMI version 1.3. It is a more extensive color space than sRGB, and allows the expression of colors that could not be expressed before. While remaining compatible with the color gamut of sRGB standards, “x.v.Color” expands the color space and can thus produce more vivid, natural images. It is particularly effective for still pictures and computer graphics.

# Sound field program information

## ■ Elements of a sound field

What really creates the rich, full tones of a live instrument are the multiple reflections from the walls of the room. In addition to making the sound live, these reflections enable us to tell where the player is situated as well as the size and shape of the room in which we are sitting. There are two distinct types of sound reflections that combine to make up the sound field in addition to the direct sound coming straight to our ears from the player's instrument.

### Early reflections

Reflected sounds reach our ears extremely rapidly (50 ms to 100 ms after the direct sound), after reflecting from one surface only (for example, from a wall or the ceiling). Early reflections actually add clarity to the direct sound.

### Reverberations

These are caused by reflections from more than one surface (for example, from the walls, and/or the ceiling) so numerous that they merge together to form a continuous sonic afterglow. They are nondirectional and lessen the clarity of the direct sound.

Direct sound, early reflections and subsequent reverberations taken together help us to determine the subjective size and shape of the room, and it is this information that the digital sound field processor reproduces in order to create sound fields.

If you could create the appropriate early reflections and subsequent reverberations in your listening room, you would be able to create your own listening environment.

The acoustics in your room could be changed to those of a concert hall, a dance floor, or a room with virtually any size at all. This ability to create sound fields at will is exactly what Yamaha has done with the digital sound field processor.

## ■ CINEMA DSP

Since the Dolby Surround and DTS systems were originally designed for use in movie theaters, their effect is best felt in a theater having many speakers designed for acoustic effects. Since home conditions, such as room size, wall material, number of speakers, and so on, can differ so widely, it is inevitable that there are differences in the sound heard.

Based on a wealth of actually measured data, Yamaha CINEMA DSP provides the audiovisual experience of a movie theater in the listening room of your own home by using the Yamaha original sound field technology combined with various digital audio systems.

## ■ CINEMA DSP 3D

The actually measured sound field data contain the information of the height of the sound images. CINEMA DSP 3D feature achieves the reproduction of the accurate height of the sound images so that it creates the accurate and intensive stereoscopic sound fields in a listening room.

## ■ SILENT CINEMA

Yamaha has developed a natural, realistic sound effect DSP algorithm for headphones. Parameters for headphones have been set for each sound field so that accurate representations of all the sound field programs can be enjoyed on headphones.

## ■ Virtual CINEMA DSP

Yamaha has developed a Virtual CINEMA DSP algorithm that allows you to enjoy DSP sound field surround effects even without any surround speakers by using virtual surround speakers. It is even possible to enjoy Virtual CINEMA DSP using a minimal two-speaker system that does not include a center speaker.

## ■ Compressed Music Enhancer

The Compressed Music Enhancer feature of this unit enhances your listening experience by regenerating the missing harmonics in a compression artifact. As a result, flattened complexity due to the loss of high-frequency fidelity as well as lack of bass due to the loss of low-frequency bass is compensated, providing improved performance of the overall sound system.

# Information on HDMI™

## ■ HDMI signal compatibility

### Audio signals

Audio signal types	Audio signal formats	Compatible media
2ch Linear PCM	2ch, 32-192 kHz, 16/20/24 bit	CD, DVD-Video, DVD-Audio, etc.
Multi-ch Linear PCM	8ch, 32-192 kHz, 16/20/24 bit	DVD-Audio, Blu-ray Disc, HD DVD, etc.
DSD	2/5.1ch, 2.8224 MHz, 1 bit	SA-CD, etc.
Bitstream	Dolby Digital, DTS	DVD-Video, etc.
Bitstream (High definition audio)	Dolby TrueHD, Dolby Digital Plus, DTS-HD Master Audio, DTS-HD High Resolution Audio, DTS Express	Blu-ray Disc, HD DVD, etc.



- If the input source component can decode the bitstream audio signals of audio commentaries, you can play back the audio sources with the audio commentaries mixed down by using the following connections:
  - multi-channel analog audio input (see page 16)
  - DIGITAL INPUT OPTICAL (or COAXIAL)
- Refer to the supplied instruction manuals of the input source component, and set the component appropriately.

### Notes

- When CPPM copy-protected DVD-Audio is played back, video and audio signals may not be output depending on the type of the DVD player.
- This unit is not compatible with HDCP-incompatible HDMI or DVI components.
- To decode audio bitstream signals on this unit, set the input source component appropriately so that the component outputs the bitstream audio signals directly (does not decode the bitstream signals on the component). Refer to the supplied instruction manuals for details.
- This unit is not compatible with the audio commentary features (for example, the special audio contents downloaded via Internet) of Blu-ray Disc or HD DVD. This unit does not play back the audio commentaries of the Blu-ray Disc or HD DVD contents.

### Video signals

This unit is compatible with the video signals of the following resolutions:

- 480i/60 Hz
- 576i/50 Hz
- 480p/60 Hz
- 576p/50 Hz
- 720p/60 Hz, 50 Hz
- 1080i/60 Hz, 50 Hz
- 1080p/60 Hz, 50 Hz, 24 Hz

# Specifications

## AUDIO SECTION

- Minimum RMS Output Power for Front, Center, Surround, Surround back
  - [U.S.A. and Canada models]
    - 1 kHz, 0.9% THD, 8 Ω ..... 90 W
    - [Other models]
      - 1 kHz, 0.9% THD, 6 Ω ..... 90 W
  - Dynamic Power (IHF)
    - [U.S.A. and Canada models]
      - Front Speakers 8/6/4/2 Ω ..... 95/110/130/150 W
      - [Other models]
        - Front Speakers 6/4/2 Ω ..... 100/110/125 W
  - Maximum Useful Output Power (JEITA) [Australia, General and Asia models]
    - 1 kHz, 10% THD, 6 Ω ..... 115 W
  - Maximum Output Power [Russia and Asia models]
    - 1 kHz, 0.7% THD, 4 Ω ..... 105 W
  - Dynamic Headroom [U.S.A. and Canada models]
    - 8 Ω ..... 0.23 dB
  - IEC Output Power [Russia and Asia models]
    - Front Speakers 1 kHz, 0.9% THD, 6 Ω ..... 90 W
  - Input Sensitivity/Input Impedance
    - PHONO [Russia, Australia, General and Asia models]
      - ..... 3.5 mV/47 kΩ
      - AV5, etc. .... 200 mV/47 kΩ
      - MULTI CH INPUT ..... 200 mV/47 kΩ
  - Maximum Input Voltage
    - PHONO (1 kHz, 0.1% THD)
      - [Russia, Australia, General and Asia models]
        - ..... 60 mV or more
        - AV5, etc. (1 kHz, 0.5% THD) ..... 2.0 V or more
  - Rated Output Voltage/Output Impedance
    - AUDIO OUT ..... 200 mV/1.2 kΩ
    - PRE OUT ..... 1.0 V/1.2 kΩ
    - SUBWOOFER (2ch Stereo & Front: Small)
      - ..... 1.0 V/1.2 kΩ
      - ZONE2 OUT ..... 200 mV/1.2 kΩ
  - Headphone Jack Rated Output/Impedance
    - AV5, etc. (1 kHz, 50 mV, 8 Ω) ..... 100 mV/470 Ω
  - Frequency Response
    - AV5 to FRONT ..... 10 Hz to 100 kHz, +0/-3 dB
  - RIAA Equalization Deviation
    - [Russia, Australia, General and Asia models]
      - PHONO ..... 0 ± 0.5 dB
  - Total Harmonic Distortion
    - PHONO to AUDIO OUT
      - [Russia, Australia, General and Asia models]
        - (20 Hz to 20 kHz, 1 V) ..... 0.02% or less
        - AV5, etc. to FRONT, Pure Direct
          - [U.S.A. and Canada models]
            - (1 kHz, 50 W, 8 Ω) ..... 0.06% or less
            - [Other models]
              - (1 kHz, 50 W, 6 Ω) ..... 0.06% or less
    - Signal to Noise Ratio (IHF-A Network)
      - PHONO Input Shorted (5.0 mV to AUDIO OUT)
        - [General model]
          - ..... 80 dB or more
        - PHONO Input Shorted (5.0 mV to AUDIO OUT)
          - [Russia, Australia and Asia models]
            - ..... 86 dB or more
          - AV5, etc. Input Shorted (250 mV to Front Speakers)
            - ..... 100 dB or more
      - Residual Noise (IHF-A Network)
        - Front Speakers ..... 150 μV or less
      - Channel Separation (1 kHz/10 kHz)
        - PHONO (Input Shorted)
          - [Russia, Australia, General and Asia models]
            - ..... 60 dB/55 dB or more
            - AV5, etc. (5.1 kΩ shortened) ..... 60 dB/45 dB or more
      - Volume Control ..... MUTE / -80 dB to +16.5 dB
      - Tone Control (Front Speakers)

- BASS Boost/Cut ..... ±10 dB at 50 Hz
- BASS Turnover Frequency ..... 350 Hz
- TREBLE Boost/Cut ..... ±10 dB at 20 kHz
- TREBLE Turnover Frequency ..... 3.5 kHz
- Filter Characteristics (fc=40/60/80/90/100/110/120/160/200 Hz)
  - H.P.F. (Front, Center, Surround, Surround back: Small)
    - ..... 12 dB/oct.
    - L.P.F. (Subwoofer) ..... 24 dB/oct.

## VIDEO SECTION

- Video Signal Type (Gray Back)
  - [U.S.A., Canada and General models] ..... NTSC
  - [Other models] ..... PAL
- Video Signal Type (Video Conversion) ..... NTSC/PAL
- Signal Level
  - Composite ..... 1 Vp-p/75 Ω
  - S-video [Russia models]
    - ..... 1 Vp-p/75 Ω (Y), 0.286 Vp-p/75 Ω (C)
    - Component ..... 1 Vp-p/75 Ω (Y)
- Maximum Input Level (Video Conversion Off)
  - ..... 1.5 Vp-p or more
- Signal to Noise Ratio ..... 50 dB or more
- Frequency Response [MONITOR OUT]
  - Component (Video Conversion Off)
    - ..... 5 Hz to 60 MHz, -3 dB

## FM SECTION

- Tuning Range
  - [U.S.A. and Canada models] ..... 87.5 to 107.9 MHz
  - [Asia and General models] ..... 87.5/87.50 to 108.0/108.00 MHz
  - [Other models] ..... 87.50 to 108.00 MHz
- 50 dB Quieting Sensitivity (IHF)
  - Mono ..... 3.0 μV (20.8 dBf)
- Signal to Noise Ratio (IHF)
  - Mono/Stereo ..... 74 dB/69 dB
- Harmonic Distortion (1 kHz)
  - Mono/Stereo ..... 0.3/0.3%
- Antenna Input (unbalanced) ..... 75 Ω

## AM SECTION

- Tuning Range
  - [U.S.A. and Canada models] ..... 530 to 1710 kHz
  - [Asia and General models] ..... 530/531 to 1710/1611 kHz
  - [Other models] ..... 531 to 1611 kHz

## GENERAL

- Power Supply
  - [U.S.A. and Canada models] ..... AC 120 V, 60 Hz
  - [General model] ..... AC 110/120/220/230-240 V, 50/60 Hz
  - [Australia model] ..... AC 240 V, 50 Hz
  - [Russia model] ..... AC 230 V, 50 Hz
  - [Asia model] ..... AC 220/230-240 V, 50/60 Hz
- Power Consumption
  - [U.S.A. and Canada models] ..... 270 W/320 VA
  - [Other models] ..... 280 W
- Standby Power Consumption
  - Standby through off ..... 0.2 W or less
  - Standby through on ..... 3 W or less
- Maximum Power Consumption
  - [Asia and General models] ..... 490 W
- Dimensions (W x H x D) ..... 435 x 151 x 364 mm (17-1/8 x 6 x 14-3/8 in)
- Weight ..... 8.5 kg (18.7 lbs)

\* Specifications are subject to change without notice.

# Index

## ■ Numerics

1 Dynamic Range, sound setup	53
1 HDMI, function setup	54
2 Display, function setup	55
2 Lipsync, sound setup	54
2ch Stereo, sound field program	26
3 Volume, function setup	55
3D DSP, sound field parameter	47
4 Input Rename, function setup	55
5.1-channel speaker layout	10
6.1-channel speaker layout	10
7.1-channel speaker layout	10
7ch Enhancer, sound field program	27
7ch Stereo, sound field program	27

## ■ A

A)Config, speaker setup	51
Action Game, sound field program	26
Adaptive DRC, 3 Volume, function setup	55
Adjusting high frequency sound	23
Adjusting low frequency sound	23
Advanced setup	60
Adventure, sound field program	25
All Channel Search mode, SIRIUS satellite radio	36
All Channel Search mode, XM satellite radio	32
AM antenna connection	18
AM tuning	29
ANTENNA jack, rear panel	5
Aspect, 1 HDMI, function setup	54
AUDIO 1/2, rear panel	5
Audio and video player connection	15
AUDIO jack	13
Audio jack	13
AUDIO L/R jack, front panel	4
AUDIO OUT, rear panel	5
Audio Output, 1 HDMI, function setup	54
Audio player connection	16
Auto Delay, 2 Lipsync, sound setup	54
Auto Preset, OPTION menu	45
Auto Setup (YPAO), troubleshooting	69
Automatic setup	19
AV 1-6, rear panel	5
AV OUT, rear panel	5

## ■ B

B)Level, speaker setup	53
Basic operation, setup menu	51
BI-AMP connection switch, advanced setup	60
Bluetooth component playback	42
Bluetooth wireless audio receiver connection	17
Bluetooth, troubleshooting	68

## ■ C

C)Distance, speaker setup	53
C.Image, decoder parameter	49
Category Search mode, SIRIUS satellite radio	36
Category Search mode, XM satellite radio	32
Cellar Club, sound field program	26
Center SP, A)Config, speaker setup	52
Center speaker	10
Center width, decoder parameter	49
Center, C)Distance, speaker setup	53
Chamber, sound field program	26
Changing information on the front panel display	24
CINEMA DSP 3D indicator, front panel display	6
CINEMA DSP basic parameter	46
CINEMA DSP indicator, front panel display	6
Clear Preset, OPTION menu	45
COAXIAL jack	13

CODE SET, remote control	7
COMPONENT VIDEO jack	13
Connect, OPTION menu	45
Connecting AM antenna	18
Connecting audio and video player	15
Connecting audio player	16
Connecting Bluetooth wireless audio Receiver	17
Connecting external amplifier	16
Connecting external decoder	16
Connecting FM antenna	18
Connecting iPod universal dock	17
Connecting multi-format player	16
Connecting power cable	18
Connecting projector	14
Connecting set-top box	15
Connecting speaker	11
Connecting speaker cable	12
Connecting the SiriusConnect	35
Connecting the SiriusConnect tuner	35
Connecting TV monitor	14
Connecting XM Mini-Tuner Home Dock	31
Connecting Zone2	57
Connection	10
Controlling other component, remote control	59
Controlling Zone2	58
Crossover Freq., A)Config, speaker setup	53
CT Level, sound field parameter	49
Cursor indicator, front panel display	6
Cursors $\Delta$ / $\nabla$ / $\triangleleft$ / $\triangleright$ , remote control	7

## ■ D

D)Equalizer, speaker setup	53
Decoder Mode, OPTION menu	44
Decoder parameter	49
Dialog Lift, sound field parameter	47
Dimension, decoder parameter	49
Dimmer, 2 Display, function setup	55
Direct number access mode, SIRIUS satellite radio	36
Direct number access mode, XM satellite radio	32
Direct, sound field parameter	49
Disconnect, OPTION menu	45
DISPLAY, remote control	7
Displaying input signal information	24
Displaying the SIRIUS Satellite Radio information	39
Displaying the XM Satellite Radio information	34
DOCK terminal, rear panel	5
Drama, sound field program	26
DSP Level, sound field parameter	46
DSP Parameter, setup menu	56

## ■ E

E)Test Tone, speaker setup	53
Editing sound field program	46
Editing surround decoder	46
Effect Level, sound field parameter	49
ENTER, remote control	7
EQ Type Select, D)Equalizer, speaker setup	53
Extended Surround, OPTION menu	44
External component operation key, remote control	7
Extra SP Assign, A)Config, speaker setup	51

## ■ F

FL Scroll, 2 Display, function setup	55
FM antenna connection	18
FM Mode, OPTION menu	44
FM tuning	29
FM/AM (CATEGORY $\triangleleft$ / $\triangleright$ ), front panel	4
Frequency tuning	29
Front L, C)Distance, speaker setup	53

Front left speaker	10
Front panel	4
Front panel display	6
Front panel display, front panel	4
Front R, C)Distance, speaker setup	53
Front right speaker	10
Front SP, A)Config, speaker setup	52
Function Setup, setup menu	54

## ■ H

Hall in Munich, sound field program	26
Hall in Vienna, sound field program	26
HDMI Auto, 2 Lipsync, sound setup	54
HDMI indicator, front panel display	6
HDMI information	74
HDMI jack	13
HDMI OUT/HDMI 1-4, rear panel	5
HDMI THROUGH, front panel	4
HDMI, troubleshooting	64
Headphones using	23
Hi-fi sound playback	23
High frequency sound adjustment	23

## ■ I

INFO, front panel	4
INFO, remote control	7
INIT, advanced setup	60
Init. Volume, 3 Volume, function setup	55
Initialize setting, advanced setup	60
INPUT $\triangleleft$ / $\triangleright$ , front panel	4
Input selection key, remote control	7
Input signal information displaying	24
Input source registration	22
Installing batteries, remote control	9
iPod playback	40
iPod universal dock connection	17
iPod, troubleshooting	68

## ■ L

LFE/Bass Out, A)Config, speaker setup	52
Low frequency sound adjustment	23

## ■ M

MAIN ZONE ON/OFF, front panel	4
MAIN/ZONE2, remote control	7
Manual Delay, 2 Lipsync, sound setup	54
Max Volume, 3 Volume, function setup	55
Memory guard, setup menu	56
MEMORY, front panel	4
MON.CHK, advanced setup	60
MONITOR OUT, rear panel	5
Mono Movie, sound field program	26
MULTI CH INPUT terminals, rear panel	5
Multi information display, front panel display	6
Multi-zone configuration	57
Music Video, sound field program	26
MUTE indicator, front panel display	6
MUTE, remote control	7

## ■ N

Numeric key, remote control	7
-----------------------------	---

## ■ O

OPTICAL jack	13
OPTIMIZER MIC jack, front panel	4
OPTION menu	43
OPTION, remote control	7
OSD Shift, 2 Display, function setup	55

## ■ P

Pairing Bluetooth components	42
Pairing, OPTION menu	45
Panorama, decoder parameter	49
Parental Lock, OPTION menu	45



PHONES jack, front panel .....	4
Placing speaker .....	10
PORTABLE jack, front panel .....	4
Power cable connection .....	18
Power Cable, rear panel .....	5
POWER, remote control .....	7
PRE OUT, rear panel .....	5
Presence left speaker .....	11
Presence right speaker .....	11
PRESET < / >, front panel .....	4
Preset Search mode, SIRIUS satellite radio .....	37
Preset Search mode, XM satellite radio .....	33
Preset tuning .....	29
PRNS L, C)Distance, speaker setup .....	53
PRNS R, C)Distance, speaker setup .....	53
PROGRAM < / >, front panel .....	4
Projector connection .....	14
PURE DIRECT, front panel .....	4
<b>■ R</b>	
Registering input source .....	22
Registering sound field program .....	22
Registering the SIRIUS Satellite Radio channels .....	37
Registering XM Satellite Radio channels .....	33
Remote control .....	7
Remote control code resetting .....	59
Remote control code setting .....	59
Remote control ID, advanced setup .....	60
Remote control signal transmitter, remote control .....	7
Remote control, controlling other component .....	59
Remote control, preparation .....	9
Remote control, troubleshooting .....	67
REMOTE ID, advanced setup .....	60
REMOTE IN/OUT terminals, rear panel .....	5
Repeat playback, iPod .....	41
Repeat, OPTION menu .....	45
Resetting Parental lock cord, advanced setup .....	60
Resetting remote control code .....	59
Resolution, 1 HDMI, function setup .....	54
RETURN, remote control .....	7
Roleplaying Game, sound field program .....	26
<b>■ S</b>	
SB Level, sound field parameter .....	49
SCENE function .....	22
SCENE IR, advanced setup .....	60
SCENE, front panel .....	4
SCENE, remote control .....	7
Sci-Fi, sound field program .....	25
Selecting SCENE .....	22
Setting remote control code .....	59
Setting the Parental Lock, SIRIUS satellite radio .....	38
Set-top box connection .....	15
Setup menu .....	50
Setup menu basic operation .....	51
SETUP, remote control .....	7
Shuffle playback, iPod .....	41
Shuffle, OPTION menu .....	45
Signal Info parameter .....	44
Signal Info, OPTION menu .....	44
SILENT CINEMA .....	28
SIRIUS indicator, front panel display .....	6
SIRIUS Satellite Radio tuning .....	35
SIRIUS Satellite Radio, troubleshooting .....	66
SIRIUS terminal, rear panel .....	5
SL Level, sound field parameter .....	49
SLEEP indicator, front panel display .....	6
Sleep timer .....	24
SLEEP, remote control .....	7
Sound field parameter .....	46
Sound field program editing .....	46
Sound field program registration .....	22
Sound selection key, remote control .....	7
Sound Setup, setup menu .....	53
SOURCE POWER, remote control .....	7
SP IMP., advanced setup .....	60
Speaker cable connection .....	12
Speaker connection .....	11
Speaker impedance, advanced setup .....	60
Speaker indicator, front panel display .....	6
Speaker layout .....	10
Speaker placement .....	10
Speaker setup .....	51
SPEAKERS terminal, rear panel .....	5
Specifications .....	75
Spectacle, sound field program .....	25
Sports, sound field program .....	26
SR Level, sound field parameter .....	49
SR PIN, advanced setup .....	60
Standard, sound field program .....	25
Standby Through, 1 HDMI, function setup .....	54
Straight decoding mode .....	28
Straight Enhancer, sound field program .....	27
STRAIGHT, front panel .....	4
Subwoofer .....	10
Subwoofer Phase, A)Config, speaker setup .....	53
Sur. L, C)Distance, speaker setup .....	53
Sur. L/R SP, A)Config, speaker setup .....	52
Sur. R, C)Distance, speaker setup .....	53
Sur.B L, C)Distance, speaker setup .....	53
Sur.B L/R SP, A)Config, speaker setup .....	52
Sur.B R, C)Distance, speaker setup .....	53
Surround back left speaker .....	10
Surround back right speaker .....	10
Surround back speaker .....	10
Surround decoder editing .....	46
Surround left speaker .....	10
Surround right speaker .....	10
SWFR, C)Distance, speaker setup .....	53
<b>■ T</b>	
The Bottom Line, sound field program .....	26
The Roxy Theatre, sound field program .....	26
Tone control .....	23
TONE CONTROL, front panel .....	4
TRANSMIT, remote control .....	7
TRIGGER OUT terminal, rear panel .....	5
Troubleshooting .....	61
Tuner indicator, front panel display .....	6
Tuner key, remote control .....	7
Tuner, troubleshooting .....	64
Tuning, AM .....	29
Tuning, FM .....	29
TUNING/CH < / >, front panel .....	4
Turning off .....	18
Turning on .....	18
TV control key, remote control .....	7
TV monitor connection .....	14
<b>■ U</b>	
Using the remote control .....	9
<b>■ V</b>	
VIDEO jack .....	13
Video jack .....	13
VIDEO jack, front panel .....	4
Video Out, OPTION menu .....	45
Video/audio jack .....	13
Virtual CINEMA DSP .....	28
VOLUME +/-, remote control .....	7
VOLUME control, front panel .....	4
VOLUME indicator, front panel display .....	6
Volume Trim, OPTION menu .....	43
<b>■ X</b>	
XM indicator, front panel display .....	6
XM Satellite Radio tuning .....	31
XM Satellite Radio, troubleshooting .....	65
XM terminal, rear panel .....	5

**■ Y**

YPAO .....	19
YPAO, troubleshooting .....	69

**■ Z**

ZONE2 CONTROL, front panel .....	4
ZONE2 indicator, front panel display .....	6
ZONE2 ON/OFF, front panel .....	4
ZONE2 OUT jacks, rear panel .....	5

“**A** MAIN ZONE ON/OFF” or “**7** POWER” (example) indicates the name of the parts on the front panel or the remote control. Refer to “Part names and functions” on page 4.

# List of remote control codes

TV		Ausind		Clatronic		Durabrand	
A.R. Systems	0274	Autovox	0249	0243, 0249, 0259,		0077, 0097, 0133,	
Acme	0260		0249, 0257, 0259,	0260, 0261, 0262,		0225	
Acura	0261, 0273	Aventura	0260, 0328	0268, 0269, 0273,	Dux	0271	
ADC	0259	Awa	0097	0274, 0328	Dwin	0224	
Admiral	0100, 0224, 0257,	Axion	0327, 0328	CMS	Dynatron	0268, 0271, 0274	
	0258, 0259, 0264,	Baird	0206	CMS Hightec	Dynex	0181, 0182	
	0265	Bang & Olufsen	0328	Coby	Elbe	0243, 0250, 0274,	
Advent	0204	Basic Line	0230, 0257	Colortyme		0328	
Adventura	0107		0261, 0262, 0268,	Commercial Solutions	Elcit	0257	
Adyson	0260, 0327, 0328		0273, 0274, 0328	0071	Electa	0270	
Agashi	0327, 0328	Bastide	0260, 0328	Concerto	ELECTRO TECH	0261	
Agazi	0259	Baur	0271, 0274	Concorde	Electroband	0057, 0101	
Aiko	0260, 0261, 0273,	Bazin	0328	Condor	Electrograph	0226	
	0274, 0327, 0328	Beko	0243, 0269, 0274,		Electrohome	0072, 0090, 0101,	
Aim	0274		0282, 0351, 0357,	Contec		0102	
Aiwa	0028, 0297	Belcor	0372, 0380		Element	0180	
Akai	0063, 0096, 0101,	Bell & Howell	0090	Contec/Cony	Elin	0260, 0268, 0271,	
	0205, 0231, 0261,	Benq	0065, 0100	0094, 0104		0273, 0274, 0327	
	0262, 0268, 0271,	Beon	0051, 0160, 0315	Continental Edison	Elite	0262, 0268, 0274	
	0273, 0274, 0327,	Best	0268, 0271, 0274	0267	Elman	0263	
	0328	Bestar	0243	Cosmel	Elta	0261, 0273, 0327	
Akiba	0262, 0274	Binatone	0243, 0268, 0274	Craig	Emerson	0065, 0072, 0077,	
Akura	0259, 0262, 0273,	Blue Sky	0260, 0328	Crosley		0082, 0085, 0090,	
	0274	Blue Star	0262, 0274			0094, 0095, 0097,	
Alaron	0327	Boots	0270	Crown		0104, 0105, 0119,	
Alba	0243, 0260, 0261,	BPL	0260, 0328			0225, 0243, 0257,	
	0262, 0266, 0269,	Bradford	0270, 0274			0274	
	0271, 0273, 0274,	Brandt	0104, 0225	CS Electronics	Emprex	0200	
	0294, 0300, 0327	Brilliant	0267, 0272	0260, 0262, 0327	Envision	0072, 0090, 0096	
Albatron	0222	Brinkmann	0228	CTC Clatronic	Epson	0156, 0201, 0309	
Alcyon	0249	Brionvega	0274	CTX	Erres	0268, 0271, 0274	
Alleron	0105		0257, 0268, 0271,	Curtis Mathes	ESA	0097	
Allorgan	0328	Britannia	0274		ESC	0328	
Allstar	0268, 0274	Brockwood	0260, 0327, 0328	CXC	Etron	0261	
America Action	0225	Broksonic	0090	Cybertron	Eurofeel	0328	
AMOi	0326	Bruns	0063, 0225	Cytron	Euro-Feel	0259	
Amplivision	0243, 0260, 0275,	BTC	0257	Daewoo	Euroline	0271	
	0328	Bush	0262		Euroman	0243, 0327, 0328	
Amstrad	0259, 0261, 0262,		0261, 0262, 0264,		Euromann	0259, 0260, 0268,	
	0273, 0274		0266, 0268, 0270,			0274	
Amtron	0104		0271, 0273, 0274,		Europhon	0260, 0263, 0268,	
Anam	0225, 0261		0282, 0286, 0294,			0274, 0327, 0328	
Anam National	0102, 0104		0300, 0328, 0329,		Expert	0275	
Anglo	0261, 0273	Candle	0351, 0388, 0394,		Exquisit	0274	
Anitech	0249, 0259, 0261,		0413	Dainichi	Fenner	0261, 0273	
	0273, 0274	Capsonic	0072, 0090, 0096,	Dansai	Ferguson	0267, 0271, 0272	
Ansonic	0243, 0250, 0261,	Carena	0107		Fidelity	0260, 0264, 0274,	
	0263, 0273, 0274	Carnivale	0259	Dantax		0327	
AOC	0072, 0090, 0096,	Carrefour	0274	Dawa	Filsai	0328	
	0103	Carver	0096	Daytron	Finlandia	0264	
Apex	0061, 0117, 0139	Cascade	0266		Finlux	0249, 0257, 0260,	
Arcam	0327, 0328	Casio	0088	De Graaf		0263, 0268, 0271,	
Arcam Delta	0260	Cathy	0261, 0273, 0274	Decca		0274, 0328	
Aristona	0268, 0271, 0274	CCE	0317		FIRST LINE	0260, 0261, 0268	
Arthur Martin	0275	Celebrity	0268, 0271, 0274	Dell	Firstline	0273, 0274, 0327,	
ASA	0257, 0265	Celera	0229, 0328	Denver		0328	
Asberg	0249, 0268, 0274	Centurion	0057, 0101	Desmet	Fisher	0065, 0243, 0257,	
Astra	0261	Century	0117	Diamant		0260, 0266, 0269,	
Asuka	0259, 0260, 0262,	CGE	0268, 0271, 0274	Diamond		0328	
	0327, 0328	Changhong	0257	DiamondVision	Flint	0268, 0274	
Atlantic	0260, 0268, 0271,	Chimei	0243, 0249	Dimensia	Formenti	0249, 0257, 0258,	
	0274, 0327	Cimline	0117	Disney		0260, 0271, 0327	
Atori	0261, 0273	Citizen	0323	Dixi	Formenti/Phoenix	0327	
Auchan	0275		0261, 0273		Fortress	0257, 0258	
Audiosonic	0243, 0260, 0261,	City	0072, 0085, 0090,	Dream Vision	Fraba	0243, 0274	
	0262, 0268, 0271,	Clarion	0096, 0104	DTS	Friac	0243	
	0274, 0328	Clarivox	0261, 0273	Dual	Frontech	0259, 0261, 0264,	
AudioTon	0243, 0260, 0328		0225	Dual-Tec		0265, 0273, 0328	
Audiovox	0104, 0144, 0225		0271	Dumont	Fujitsu	0023, 0024, 0025,	
						0105, 0328	
					Fujitsu General	0328	

Fujitsu Siemens	0425, 0426, 0427, 0428, 0429	Hinari	0261, 0262, 0266, 0268, 0271, 0273, 0274	Kaisui	0260, 0261, 0262, 0270, 0273, 0274, 0327, 0328	Magnavox	0072, 0088, 0090, 0091, 0095, 0096, 0098, 0114, 0115, 0129, 0134, 0176, 0178, 0189, 0210
Funai	0033, 0034, 0035, 0036, 0037, 0097, 0104, 0105, 0225, 0259	Hisawa Hisense Hitachi	0262, 0270, 0275 0165 0006, 0014, 0015, 0016, 0042, 0072, 0090, 0094, 0173, 0254, 0255, 0256, 0260, 0264, 0265, 0266, 0274, 0285, 0300, 0319, 0328, 0348, 0349, 0385, 0402, 0410	Kamosonic Kamp Kapsch Karcher	0260 0260, 0327 0265 0243, 0260, 0261, 0271, 0274	Magnum Majestic Mandor	0259, 0261 0100 0259
Futuretech	0104, 0225			Kawasho	0072, 0090, 0101, 0327	Manesth	0259, 0260, 0268, 0271, 0274, 0328
Galaxi	0269, 0274			KEC	0225	Marantz	0072, 0088, 0090, 0096, 0158, 0268, 0271, 0274
Galaxis	0243, 0274			Kendo	0243, 0263, 0264, 0274		
Gateway	0163, 0226, 0227			Kenwood	0072, 0090, 0096	Marelli	0257
GBC	0261, 0266, 0273			KIC	0328	Mark	0268, 0271, 0273, 0274, 0327, 0328
GE	0069, 0071, 0072, 0073, 0077, 0090, 0099, 0102, 0106, 0112, 0131	Hornlyphon	0268, 0274	Kingsley	0260, 0327		
Geant Casino	0275	Hoshai	0262	KLH	0117	Masuda	0328
GEC	0260, 0265, 0268, 0271, 0274, 0328	Huanyu	0260, 0327, 0328	Kloss Novabeam	0104, 0107	Matsui	0260, 0261, 0264, 0266, 0268, 0271, 0273, 0274, 0328, 0405
Geloso	0261, 0264, 0273	Hygashi	0260, 0261, 0273, 0327, 0328	Kneissel	0243, 0250, 0274		
General Technic	0261, 0273	Hyper	0260, 0261, 0273, 0327, 0328	Kolster	0268, 0274		
Genexxa	0262, 0265, 0268, 0274	Hypson	0259, 0260, 0268, 0270, 0271, 0274, 0275, 0328	Konka	0262	Matsushita	0067
GFM	0177, 0210			Korpel	0268, 0271, 0274	Maxent	0193, 0226
Giant	0328	Hyundai	0223	Korting	0243, 0257	Mediator	0268, 0271, 0274
Gibraltar	0076, 0090, 0096, 0108	Iberia	0274	Kosmos	0274	Medion	0259, 0261, 0274
GoldHand	0327	ICE	0259, 0260, 0261, 0262, 0268, 0273, 0274, 0327, 0328	Koyoda	0261	Megapower	0222
Goldline	0274			KTV	0085, 0096, 0104, 0225, 0229, 0260, 0328	Megatron	0072, 0077
GoldStar	0072, 0077, 0085, 0090, 0094, 0096, 0103, 0243, 0260, 0261, 0264, 0268, 0271, 0273, 0274, 0327, 0328	ICeS	0327	Kyoto	0327, 0328	MElectronic	0273, 0274, 0327, 0328
		Ilo	0198, 0203	Lasat	0243	Melvox	0275
		IMA	0104	Lenco	0261, 0273	Memorex	0065, 0072, 0077, 0100, 0103, 0133, 0219, 0261, 0273
		Imperial	0243, 0249, 0265, 0268, 0269, 0274	Lenoir	0260, 0261, 0273		
		Indiana	0268, 0271, 0274	Leyco	0259, 0268, 0271, 0274	Memphis	0261, 0273
Goodmans	0164, 0259, 0261, 0266, 0268, 0271, 0273, 0274, 0322, 0328, 0395, 0399, 0412	Infinity	0088	LG	0016, 0038, 0039, 0077, 0103, 0145, 0222, 0243, 0246, 0253, 0260, 0261, 0264, 0268, 0271, 0273, 0274, 0282, 0290, 0299, 0316, 0327, 0328, 0351, 0359, 0367, 0382, 0384, 0389, 0396	Mercury	0273, 0274
		InFocus	0168, 0277, 0313, 0397, 0430			Metz	0257
		Ingelen	0265			MGA	0072, 0077, 0090, 0096, 0103
		Ingersol	0261, 0273			Micromaxx	0259, 0261
Gorenje	0243, 0269	Initial	0203			Microstar	0259, 0261
GPM	0262	Inno Hit	0249, 0260, 0261, 0262, 0268, 0271, 0273, 0274, 0328			Midland	0069, 0071, 0073, 0076, 0085, 0106, 0108
GPX	0211						
Gradiente	0162	Innovation	0259, 0261			Minerva	0249
Graetz	0265	Insignia	0182, 0188, 0190, 0209	LG/GoldStar	0246	Minoka	0268, 0274
Granada	0249, 0260, 0264, 0266, 0268, 0271, 0274, 0275, 0328	Inteq	0076	Liesenk	0271	Mintek	0203
Grandin	0261, 0262, 0270, 0271	Interactive	0243	Liesenkotter	0274	Mitsubishi	0006, 0015, 0016, 0048, 0072, 0077, 0090, 0103, 0196, 0224, 0257, 0266, 0268, 0274, 0298, 0371
Gronic	0328	Interbuy	0261, 0273	Life	0259, 0261		
Grundig	0242, 0243, 0249, 0274, 0356	Interfunk	0243, 0257, 0265, 0268, 0271, 0274	Lifetec	0259, 0261, 0273, 0274	Mivar	0243, 0249, 0250, 0260, 0327, 0328
Grunpy	0104, 0105, 0225	International	0327	Lloyds	0273		
Haier	0187, 0207	Intervision	0243, 0259, 0260, 0263, 0274, 0328	Loewe	0243, 0250, 0274, 0280, 0306, 0347		
Halifax	0259, 0260, 0327, 0328	Irradio	0249, 0261, 0262, 0268, 0271, 0273, 0274	Loewe Opta	0257, 0268, 0271	Monivision	0222
Hallmark	0072, 0077, 0090			Logik	0100	Montgomery Ward	0100
Hampton	0260, 0327, 0328	Isukai	0262, 0274	Luma	0264, 0271, 0273, 0274		
Hanseatic	0243, 0250, 0260, 0261, 0266, 0268, 0271, 0273, 0274, 0328	ITC	0260, 0328	Lumatron	0264, 0268, 0271, 0274, 0328	Motion	0249
		ITS	0262, 0268, 0270, 0274, 0327	Lux May	0268	Motorola	0102, 0224
		ITV	0261, 0265	Luxman	0072, 0090	MTC	0072, 0090, 0096, 0103, 0243, 0327
Hantarex	0261, 0273, 0274	ITT	0261, 0271, 0274	Luxor	0260, 0264, 0328	Multi System	0271
Hantor	0274	ITV	0261, 0271, 0274	LXI	0061, 0065, 0071, 0072, 0073, 0077, 0088, 0099	Multitech	0104, 0225, 0229, 0243, 0260, 0261, 0263, 0264, 0266, 0271, 0273, 0274, 0327, 0328
Harman/Kardon	0088	Jancil	0107				
Harvard	0104, 0225	JBL	0088			Murphy	0260, 0327
Harwood	0273, 0274	JC Penney	0072, 0073, 0085, 0090, 0099, 0103, 0106	M Electronic	0260, 0261, 0265, 0267, 0268, 0271	NAD	0061, 0072, 0077
Havermy	0224			MAG	0050	Naonis	0264
HCM	0259, 0260, 0261, 0270, 0273, 0274, 0328	JCB	0057, 0101	Magnadyne	0257, 0263, 0271	NEC	0266, 0053, 0072, 0090, 0096, 0102, 0103, 0266, 0328
		Jensen	0072, 0090	Magnafon	0249, 0260, 0263, 0327		
Hema	0273, 0328	JVC	0017, 0018, 0019, 0092, 0093, 0094, 0106, 0251, 0252, 0266, 0268, 0293, 0360, 0379				
Hewlett Packard	0146						
Higashi	0327						
HiLine	0274						



Sylvania	0072, 0088, 0089, 0090, 0091, 0095, 0096, 0097, 0098, 0175, 0177, 0210	Triumph	0274	Adventura	1023	Dumont	1072, 1078
		Uher	0243, 0249, 0265, 0268, 0274	Adyson	1090	Durabrand	1032
		Ultravox	0257, 0260, 0263, 0274, 0327	Aiwa	1023, 1072, 1073, 1074	Dynatech	1023
Symphonic	0097, 0104, 0108, 0133, 0210, 0225	Unic Line	0274	Akai	1071, 1073	Echostar	1064
Syntax	0149	United	0271	Akiba	1079, 1090	Elbe	1091
Syntax-Brilliant	0149	Universum	0243, 0249, 0259, 0268, 0269, 0271, 0274, 0328	Akura	1073, 1079, 1090	Elcotech	1090
Sysline	0271			Alba	1074, 1075, 1076, 1079, 1090, 1091	Electrohome	1021
Sytong	0327			Alienware	1066	Electrohome	1021
Tandy	0224, 0258, 0260, 0262, 0265, 0328	Univox	0274	American High	1022	Elsay	1090
		Vector Research	0096	Amstrad	1072, 1090, 1091	Elta	1079, 1090, 1091
Tashiko	0260, 0264, 0266, 0327, 0328	Vestel	0264, 0265, 0268, 0269, 0271, 0274, 0328	Anitech	1079, 1090	Emerson	1021, 1022, 1023, 1070, 1090
				Apex	1010	ESC	1075, 1091
Tatung	0102, 0227, 0260, 0268, 0271, 0274, 0328	Vexa	0261, 0271, 0273, 0274	ASA	1077, 1078	Etzuko	1079, 1090
				Asha	1020	Expressvu	1064
TCM	0259, 0261	Victor	0093, 0266, 0268	Asuka	1072, 1077, 1078, 1079, 1090	Ferguson	1073
Teac	0274, 0328	VIDEOLOGIC	0327	Audio Dynamics	1018	Fidelity	1072, 1090
Tec	0260, 0261, 0273, 0328	Videologique	0260, 0262, 0327, 0328	Audiosonic	1091	Finlandia	1078
Technics	0067, 0069, 0106	VideoSystem	0268, 0274	Audiovox	1021	Finlux	1072, 1073, 1078
TechniSat	0320, 0417, 0418, 0419	Videtechnic	0327, 0328	Baird	1072, 1073, 1075, 1091	Firstline	1074, 1077, 1079, 1090
		Vidikron	0088	Bang & Olufsen	1067	Fisher	1019
Techwood	0069, 0072, 0090, 0106	Vidtech	0072, 0077, 0090, 0103	Basic Line	1074, 1075, 1076, 1079, 1090, 1091	Flint	1074
TEDELEX	0328	Viewsonic	0153, 0186, 0226, 0318	Baur	1078	Formenti/Phoenix	1078
Teknika	0072, 0085, 0088, 0090, 0094, 0100, 0103, 0104, 0105, 0225	Viking	0107	Beaumarck	1020	Frontech	1076
		Viore	0198	Bell & Howell	1019	Fuji	1022
Teleavia	0267	Visiola	0260, 0327	Bestar	1075, 1076, 1091	Fujitsu	1072
Telecor	0274, 0328	Vision	0268, 0274, 0328	Black Panther Line	1075, 1091	Funai	1023, 1072
Telefunken	0267, 0268, 0272, 0274	Vizio	0090, 0136, 0160, 0227, 0420, 0421, 0422, 0423, 0424	Blaupunkt	1078	Galaxy	1072
				Bondstec	1076, 1090	Garrard	1023
Telegazi	0274	Vortec	0268, 0271, 0274	Broksonic	1054	Gateway	1066
Telemeister	0274	Voxson	0249, 0257, 0264, 0265, 0268, 0274	Bush	1074, 1075, 1079, 1090, 1091, 1097, 1099, 1109, 1139	GBC	1076, 1079
Telesonic	0274			Calix	1021	GE	1020, 1022
Telestar	0274	Waltham	0260, 0274, 0328	Candle	1020, 1021	GEC	1078
Teletech	0261, 0271, 0273, 0274	Wards	0072, 0077, 0088, 0090, 0091, 0096, 0098, 0099, 0100, 0103, 0105	Canon	1022	Geloso	1079
				Cathay	1091	General	1076
Teleton	0260, 0328			Catron	1076	General Technic	1074
Televideon	0327			CGE	1072, 1073	GOI	1064
Televideo	0275	Watson	0268, 0271, 0274	Cimline	1074, 1079, 1090	GoldHand	1079, 1090
Tensai	0261, 0262, 0268, 0273, 0274, 0328	Watt Radio	0260, 0263, 0327	CineVision	1058	Goldstar	1018, 1021, 1072, 1077
		Waycon	0061	Citizen	1020, 1021	Goodmans	1072, 1075, 1076, 1077, 1079, 1090, 1091
Tesmet	0268	Wega	0257, 0266, 0274	Clatronic	1076, 1090	Gradiente	1023
Tevion	0259, 0261	Weltblick	0268, 0271, 0274, 0328	Colortyme	1018	Graetz	1073
Textet	0260, 0273, 0327, 0328	Westinghouse	0057, 0138, 0142	Condor	1075, 1076, 1091	Granada	1078
		White Westinghouse	0008, 0119, 0260, 0263, 0271, 0274, 0327	Craig	1020, 1021	Grandin	1072, 1075, 1076, 1077, 1079, 1090, 1091
Thomson	0238, 0239, 0240, 0260, 0267, 0268, 0272, 0274, 0335			Crown	1075, 1076, 1079, 1090, 1091	Grundig	1078, 1079
				Curtis Mathes	1018, 1020, 1022	Hanseatic	1077, 1078, 1091
Thorn	0271, 0274	Wincom	0055, 0056	Cybernex	1020	Harley Davidson	1023
TMK	0072, 0077, 0090	Xrypton	0274	CyberPower	1066	Harman/Kardon	1018
TNCi	0076	Yamaha	0000, 0001, 0002, 0003, 0004, 0005, 0072, 0090, 0096, 0103	Daewoo	1023, 1075, 1076, 1091, 1116, 1141	Harwood	1090
Tokai	0268, 0274, 0328			Dansai	1079, 1090, 1091	HCM	1079, 1090
Tokyo	0260, 0327			Dantax	1074	Headquarter	1019
Tomashi	0270			Daytron	1075, 1091	Hewlett Packard	1066
Toshiba	0027, 0043, 0053, 0054, 0061, 0062, 0063, 0064, 0065, 0122, 0123, 0124, 0128, 0130, 0132, 0139, 0214, 0244, 0266, 0283, 0305, 0328, 0329, 0342, 0350, 0352, 0353, 0354, 0375, 0404	Yamishi	0274, 0328	De Graaf	1078	Hinari	1074, 1079, 1090, 1091
		Yokan	0274	Decca	1072, 1073, 1078	Hisawa	1074
		Yoko	0243, 0259, 0260, 0261, 0262, 0268, 0271, 0273, 0274, 0327, 0328	Dell	1066	Hitachi	1072, 1073, 1078, 1089, 1108, 1124
				Denko	1090	HNS	1060
				DiamondVision	1050	Howard Computers	1066
		Yorx	0262	DigiFusion	1092	HP	1066
		Zanussi	0264, 0328	DIRECTV	1035, 1038, 1040, 1059, 1060, 1061, 1065	HTS	1064
		Zenith	0076, 0077, 0078, 0079, 0090, 0100, 0108, 0111	Dish Network	1064	Hughes	1035, 1040, 1061
				Dishpro	1064	Hughes Network Systems	1038, 1060
Totevision	0085			Dual	1073, 1078, 1091	Hush	1066
Towada	0265, 0328					Hypson	1074, 1079, 1090, 1091
Trakton	0328						
Trans Continens	0274, 0328						
Transtec	0327						
Trident	0328						

---

**VCR**

ABS 1066

iBUYPOWER	1066	Multitech	1020, 1023, 1072,	Ricavision	1066	Telefunken	1073
Impego	1076		1076, 1078, 1079,	Roadstar	1075, 1077, 1079,	Teletech	1090, 1091
Imperial	1072		1090		1090, 1091	Tenosal	1079, 1090
Inno Hit	1075, 1076, 1078,	Murphy	1072	Royal	1090	Tensai	1072, 1077, 1079,
	1079, 1090, 1091	NEC	1018, 1019, 1073	Runco	1032		1090
Innovation	1074	Neckermann	1073, 1078	Saba	1073	Tevion	1074
Instant Replay	1022	NEI	1078	Saisho	1074, 1079	Thomson	1073, 1087
Interbuy	1077, 1090	Nesco	1079, 1090	Samsung	1006, 1020, 1038,	Thorn	1073
Interfunk	1078	Nikkai	1076, 1090, 1091		1040, 1046, 1060,	Tivo	1035, 1036, 1037,
Intervision	1072, 1091	Nikko	1021		1080, 1107, 1110,		1039, 1040, 1060,
Irradio	1077, 1079, 1090	Niveus Media	1066		1112, 1121, 1123,		1061, 1062
ITT	1073	Noblex	1020		1140, 1142	TMK	1020
ITV	1075, 1077, 1091	Nokia	1073, 1091	Samurai	1076, 1090	Tokai	1077, 1079, 1090
JC Penney	1018, 1019, 1020,	Nordmende	1073	Sanky	1032	Tonsai	1079
	1021, 1022	Northgate	1066	Sansui	1033, 1056, 1069,	Toshiba	1004, 1005, 1034,
JCL	1022	Oceanic	1072, 1073		1073		1051, 1063, 1066,
JVC	1011, 1012, 1013,	Okano	1074, 1090, 1091	Sanyo	1019, 1020, 1114		1073, 1078, 1086,
	1014, 1015, 1016,	Olympus	1022	Saville	1091		1099, 1102, 1119,
	1017, 1018, 1019,	Optimus	1021	SBR	1078		1144
	1028, 1035, 1064,	Orion	1033, 1069, 1074,	Schaub Lorenz	1072, 1073	Totevision	1020, 1021
	1073, 1085, 1117,		1097, 1139	Schneider	1072, 1074, 1075,	Touch	1066
	1130, 1131, 1133,	Orson	1072		1076, 1077, 1078,	Towada	1079, 1090
	1134, 1135, 1136	Osaki	1072, 1077, 1079,		1079, 1090, 1091	Towika	1079, 1090
Kaisui	1079, 1090		1090	Sears	1019, 1021, 1022	TVA	1076
Karcher	1078	Otto Versand	1078	SEG	1079, 1090, 1091	Uher	1077
Kendo	1074, 1075, 1076,	Palladium	1073, 1077, 1079,	SEI-Sinudyne	1078	UltimateTV	1065
	1090		1090	Seleco	1073	Ultravox	1091
Kenwood	1018, 1019, 1073	Panasonic	1007, 1008, 1009,	Sentra	1076, 1090	Unitech	1020
Kodak	1021, 1022		1022, 1026, 1042,	Sentron	1079, 1090	United Quick Star	1075, 1091
Korpel	1079, 1090		1043, 1068, 1082,	Sharp	1031, 1045, 1057,	Universum	1072, 1077, 1078
Kyoto	1090		1101, 1126, 1132		1081, 1115, 1137	Vector Research	1018
Lenco	1075	Pathe Marconi	1073	Shintom	1079, 1090	Video Concepts	1018
Leyco	1079, 1090	Perdio	1072	Shivaki	1077	Videon	1074
LG	1021, 1053, 1072,	Philco	1022, 1090	Shogun	1020	Videosonic	1020
	1077, 1088, 1100,	Philips	1022, 1030, 1035,	Siemens	1077	Viewsonic	1066
	1106, 1125, 1143		1038, 1039, 1040,	Silva	1077	Voodoo	1066
Lifetec	1074		1044, 1055, 1060,	Silver	1091	Wards	1020, 1021, 1022,
Linksys	1066		1078, 1084, 1095,	Singer	1022		1023
Lloyd's	1023		1096, 1104, 1105,	Sinudyne	1078	Weltblick	1077
Loewe Opta	1077, 1078		1111, 1113, 1122,	Solavox	1076	XR-1000	1022, 1023
Logik	1079, 1090		1124, 1127, 1128,	Sonic Blue	1041, 1068	Yamaha	1018, 1019
Lumatron	1075, 1091		1129	Sonneclair	1090	Yamishi	1079, 1090
Luxor	1090	Philips Magnavox	1030	Sonoko	1075, 1091	Yokan	1079, 1090
LXI	1021	Phonola	1078	Sontec	1077	Yoko	1076, 1077, 1079,
M Electronic	1072	Pilot	1021	Sony	1000, 1001, 1002,		1090
Magnavox	1022, 1032, 1044,	Pioneer	1078, 1118		1003, 1024, 1027,	Zenith	1032
	1070	Polaroid	1010, 1049		1036, 1062, 1066,	ZT Group	1066
Magnin	1021	Portland	1075, 1076, 1091		1083, 1098, 1103,		
Manesth	1079, 1090	Prinz	1072		1138		
Marantz	1018, 1019, 1022,	Profex	1079	Stack	1066	<b>DVD</b>	
	1078	Proline	1072	Stack 9	1066	4Kus	2097
Mark	1091	Proscan	1065	Standard	1075, 1091	Accurian	2220
Marta	1021	Prosonic	1074, 1091	Stern	1091	Advent	2169, 2201
Matsui	1074, 1077	Pulsar	1032	ST5	1022	AEG	2312
Matsushita	1022	Pye	1052, 1078	Sunkai	1074	Airis	2318
Media Center PC	1066	Quarter	1019	Sunstar	1072	Aiwa	2272
Mediator	1078	Quartz	1019	Suntronic	1072	Akai	2170, 2195, 2225,
Medion	1074	Quasar	1022	Sunwood	1079, 1090		2227
MEI	1022	Quelle	1072, 1078	Superscan	1070	Akura	2310
Memorex	1019, 1020, 1021,	Radialva	1090	Sylvania	1022, 1023, 1044,	Alba	2018, 2232, 2247,
	1022, 1023, 1032,	RadioShack	1021		1052, 1070		2259, 2264
	1048, 1069, 1072,	RadioShack/Realistic		Symphonic	1023, 1044, 1090	Alco	2199
	1077		1019, 1020, 1021,	Systemax	1066	Alize	2315
	1079, 1090		1022, 1023	Tagar Systems	1066	Allegro	2215
Memphis	1020	Radiola	1078	Taisho	1074	Amitech	2312
MGN Technology	1074	Radix	1021	Tandberg	1091	Amphion MediaWorks	
Micromaxx	1066	Randex	1021	Tandy	1019		2145
Microsoft	1074	RCA	1020, 1022, 1025,	Tashiko	1021, 1072	AMW	2145, 2313
Microstar	1072		1035, 1040, 1047,	Tatung	1072, 1073, 1078	Apex	2044, 2045, 2046,
Migros	1066		1060, 1065	TCM	1074, 1093, 1120		2047, 2076, 2208,
Mind	1029, 1072, 1078	Realistic	1019, 1020, 1021,	Teac	1023, 1091		2209
Mitsubishi	1022		1022, 1023	Tec	1076, 1090, 1091	Apple	2163
Motorola	1020	ReplayTV	1041, 1068	Technics	1022	Argo	2216
MTC		Rex	1073	Teknika	1021, 1022, 1023	Asono	2318
		RFT	1076, 1078, 1090	Teleavia	1073	Aspire	2140, 2202
						Astar	2162

ATACOM	2318	Enzer	2302	LG	2080, 2107, 2115,	2252, 2256, 2260,
Audiovox	2111, 2199	Epson	2165		2116, 2141, 2188,	2268, 2282, 2332,
Avious	2317	ESA	2219		2211, 2215, 2237,	2333, 2343, 2344,
Awa	2313	Finlux	2304, 2312, 2317		2239, 2285, 2293,	2345, 2367, 2371,
Axion	2171	Fintec	2299		2295, 2348, 2370	2373, 2380, 2382,
Bang & Olufsen	2210	Fisher	2212	Life	2228	2385
Baze	2317	Funai	2219	Lifetec	2228	Phonotrend 2317
BBK	2318	Gateway	2097	Limit	2305	Pioneer 2012, 2013, 2014,
Bellagio	2313	GE	2079, 2206, 2209	Liquid Video	2204	2063, 2064, 2065,
Best Buy	2309	Gericom	2269	Liteon	2097, 2121, 2220	2066, 2067, 2113,
Blaupunkt	2209	GFM	2176	Loewe	2274	2134, 2207, 2230,
Blue Parade	2207	Giec	2300	LogicLab	2305	2236, 2265, 2266,
Boghe	2300	Global Solutions	2305	Magnavox	2075, 2096, 2178,	2267, 2297, 2322,
Brainwave	2312	Global Sphere	2305		2180, 2196, 2205,	2351, 2352, 2353,
Brandt	2198, 2238	Go Video	2135, 2215		2219, 2308	2354, 2355, 2356,
Broksonic	2192, 2195	Goodmans	2247, 2289, 2298,	Magnex	2317	2357, 2358, 2359,
Bush	2018, 2060, 2248,		2300, 2308, 2330,	Majestic	2314	2377
	2264, 2301, 2308,		2369	Marantz	2282	Pointer 2312
	2317, 2350, 2368	GPX	2177	Marquant	2312	Polaroid 2047, 2133, 2185
California Audio Labs		Gradiente	2197	Matsui	2198, 2296	Portland 2312
	2197	Graetz	2302	McIntosh	2149	Powerpoint 2313
Cambridge Audio	2304	Greenhill	2209	Mecotek	2312	Prima 2174
CAT	2306, 2307	Grundig	2271	Medion	2228	Proceed 2208
CAVS	2146	Grunkel	2312, 2316	Memorex	2078, 2184, 2195	Proscan 2206
Centrum	2307	GVG	2299	MiCO	2300, 2304	Prosonic 2299, 2314
CGV	2304, 2312	H&B	2308	Micromaxx	2228	Protron 2152
Changhong	2222	H_her	2318	Microsoft	2206	Provision 2308
Cinetec	2313	Haaz	2304, 2305	Microstar	2228	Pye 2194
CineVision	2191, 2215	Haier	2172	Minoka	2312	Qwestar 2198
Clatronic	2308, 2317	Hamman/Kardon	2125, 2213	Minowa	2317	Raite 2302
Coby	2077, 2124, 2314	HiMAX	2309	Mintek	2167, 2209	RCA 2058, 2059, 2071,
Conia	2301	Hitachi	2008, 2033, 2108,	Mitsubishi	2081	2079, 2183, 2199,
Continental Edison			2302, 2309, 2320,	Mizuda	2308, 2309	2206, 2207, 2209
	2313		2366	Monyka	2302	RedStar 2310, 2312, 2314
Crown	2312	Hiteker	2208	Mustek	2232	Regent 2203
C-Tech	2305	Home Tech Industries		Mx Onda	2304	Reoc 2305
Curtis Mathes	2217		2318	Mystral	2316	Rimax 2315
CVG	2299	Hyundai	2316	Naiko	2312	Rio 2215
CyberHome	2048, 2068, 2216,	Ilo	2167	Nesa	2209	Roadstar 2281, 2308
	2233, 2258	Initial	2167, 2209	Neufunk	2302	Ronin 2313
Cytron	2166	Innovation	2228	Nevir	2312	Rotel 2153
Daenyx	2313	Insignia	2080, 2175, 2219	Next Base	2221	Rowa 2200, 2301
Daewoo	2083, 2215, 2280,	Integra	2207	Nexstech	2161	Rownsonic 2307
	2299, 2312, 2313,	Irradio	2103	NU-TEC	2301	Saba 2198, 2238
	2326, 2376	iSymphony	2164	Onkyo	2205, 2290	Sabaki 2305
Daewoo International		JBL	2213	Oopla	2097	Saivod 2312
	2313	JVC	2049, 2050, 2051,	Oppo	2150, 2173	Sampo 2223
Dalton	2311		2052, 2053, 2054,	Optim	2303	Samsung 2031, 2032, 2033,
Dansai	2303, 2312		2055, 2056, 2057,	Optimus	2230	2034, 2035, 2082,
Daytek	2145, 2234, 2313		2070, 2242, 2261,	Orava	2308	2127, 2137, 2138,
Dayton	2313		2275, 2276, 2277,	Orbit	2313	2154, 2182, 2197,
DEC	2308		2278, 2339, 2340,	Orion	2027, 2060	2283, 2319, 2325,
Decca	2312		2341, 2342, 2386,	Oritron	2198, 2204	2346, 2347, 2349,
Denon	2105, 2147, 2197,		2387, 2389, 2390,	P&B	2308	2372, 2381
	2286		2391	Pacific	2305	Sansui 2027, 2195, 2304,
Denver	2288, 2308, 2310,	Jwin	2148	Panasonic	2015, 2016, 2017,	2305, 2312
	2314	Kansai	2314		2036, 2037, 2038,	Sanyo 2139, 2195, 2212,
Denzel	2302	Kawasaki	2199		2039, 2040, 2041,	2374
Desay	2159	Kennex	2312		2042, 2043, 2074,	ScanMagic 2232
Diamond	2304, 2305	Kenwood	2123, 2197, 2270		2089, 2104, 2108,	Schaub Lorenz 2312
DiamondVision	2179, 2186	KeyPlug	2312		2112, 2120, 2131,	Schneider 2226
Disney	2078, 2088	Kiirro	2312		2132, 2197, 2205,	Scientific Labs 2305
DK Digital	2257	Kingavon	2308		2244, 2245, 2246,	Scott 2243, 2311
Dmtech	2226	Kiss	2302		2253, 2254, 2255,	Seeltech 2318
Dual	2302	KLH	2199, 2209		2292, 2321, 2324,	SEG 2240, 2302, 2305,
Durabrand	2218	Koda	2308		2327, 2328, 2329,	2313
DVX	2305	Koss	2095, 2198, 2204		2331, 2383, 2388	Sharp 2009, 2010, 2084,
Easy Home	2309	KXD	2309	Parasound	2151	2122, 2142, 2143,
Eclipse	2304	Landel	2221	peeKTON	2318	2144, 2181, 2190,
E-Dem	2318	Lasonic	2214	Philips	2026, 2061, 2062,	2228, 2262, 2375
Electrohome	2312	Lawson	2305		2075, 2090, 2094,	Shinsonic 2167
Elin	2312	Lecson	2303		2096, 2097, 2103,	Sigmathek 2309, 2318
Elta	2263, 2312, 2315	Lenco	2308, 2312, 2317		2110, 2126, 2180,	Silva 2310
Emerson	2196, 2211, 2219	Lenox	2203, 2218		2193, 2205, 2231,	Singer 2304, 2305
Enterprise	2211				2235, 2241, 2251,	Skymaster 2279, 2305

Skyworth	2310	Woxter	2315, 2318	Alcatel	3066	Movie Time	3031, 3063
Slim Art	2312	Xbox	2206, 2229	Americast	3046	Mr Zapp	3055
SM Electronic	2305	Xlogic	2305, 2312	Amstrad	3048, 3068	Multichoice	3057
Sonic Blue	2215	XMS	2312	Antronix	3019, 3020	Multitech	3045
Sontech	2316	Xoro	2300	Archer	3020	NEC	3018
Sony	2005, 2006, 2007, 2020, 2021, 2022, 2023, 2024, 2025, 2069, 2072, 2073, 2085, 2086, 2087, 2091, 2092, 2093, 2102, 2128, 2129, 2130, 2249, 2250, 2323, 2334, 2335, 2336, 2360, 2361, 2362, 2363, 2364, 2365, 2384	Yamada	2097, 2313, 2315	Arcon	3048	NET Brazil	3007
Soundmaster	2305	Yamaha	2000, 2001, 2002, 2003, 2011, 2018, 2019, 2036, 2106, 2197, 2273	AT&T	3013	Nokia	3051
Soundmax	2305	Yamakawa	2302, 2313	Axis	3048	Noos	3055
Spectra	2313	Yukai	2232	Bell South	3046	NSC	3031
Spectroniq	2155	Zenith	2080, 2141, 2205, 2211, 2215	Cable Vision	3014	Oak	3024
Standard	2305			Cabletenna	3019	Pace	3011, 3043, 3084
Star Cluster	2305			Cabletime	3058	Palladium	3049
Starmedia	2308, 2318			Cableview	3005	Panasonic	3034, 3036, 3040
Sungale	2158			Clearmaster	3045	Paragon	3040
Sunkai	2312			ClearMax	3045	Philips	3021, 3022, 3029, 3049, 3053, 3054, 3055
Superscan	2196			Clyde Cablevision	3059	Pioneer	3012, 3032, 3038, 3042, 3048, 3083, 3084
Supervision	2305			Colour Voice	3022	Popular Mechanics	3044
Sylvania	2094, 2180, 2189, 2196, 2219, 2224, 2062, 2180			Comcast	3006, 3010, 3039	Proscan	3015, 3016
Symphonic	2305			Comcrypt	3057	Pulsar	3040
Synn	2305			Comtronics	3023	PVP Stereo Visual Matrix	3064
T.D.E. Systems	2316			Contec	3024	Quasar	3040
Tatung	2083, 2312			Coolmax	3045	RadioShack	3041, 3045
TCM	2228, 2379			COX	3006	RCA	3005, 3036, 3076, 3077
Teac	2199, 2287, 2301, 2305			Cryptovision	3060	Realistic	3020
Tec	2310			Director	3006	Recoton	3044
Technics	2197			Eastern	3025	Regal	3028
Technika	2312, 2317			Everquest	3041	Regency	3025
Telefunken	2307			Fidelity	3048	Rembrandt	3016
Tensai	2312			Filmnet	3057	Runco	3040
Tevion	2228, 2305, 2311			Filmnet Cablecrypt	3061	Sagem	3055
Theta Digital	2207			Filmnet Comcrypt	3061	Samsung	3011, 3023, 3032, 3042
Thomson	2229, 2238, 2284, 2294			Finlux	3051	SAT	3048
Tokai	2302, 2310			Focus	3044	Scientific Atlanta	3003, 3004, 3011, 3012, 3013, 3062, 3078, 3079, 3080, 3081, 3082, 3083, 3084
Top Sucess	2318			Foxtel	3068	Signal	3026, 3041
Toshiba	2004, 2026, 2027, 2028, 2029, 2030, 2098, 2099, 2100, 2101, 2114, 2117, 2118, 2119, 2136, 2187, 2195, 2205, 2291, 2337, 2338, 2378			France Telecom	3054, 3055	Signature	3016
TRANScontinents	2313, 2317			Freebox	3069	Sony	3014, 3047
Trasonic	2317			GC Electronics	3020	Sprucer	3036
Trio	2312			GE	3015, 3016	Standard Component	3033
Trutech	2160			GEC	3059	Starcom	3026, 3037, 3041, 3067
TruVision	2309			Gemini	3026, 3041	Stargate	3026, 3041
TSM	2318			General Instrument	3006, 3008, 3016, 3039, 3050, 3067, 3075	Starquest	3026, 3041
Umax	2315				3006, 3008, 3016, 3039, 3050, 3067, 3075	Supercable	3008
United	2317				3006, 3008, 3016, 3026, 3037, 3041, 3050, 3064, 3067, 3075	Supermax	3045
Urban Concepts	2205				3006, 3008, 3016, 3026, 3037, 3041, 3050, 3064, 3067, 3075	Tele+1	3057, 3061
US Logic	2167				3006, 3008, 3016, 3026, 3037, 3041, 3050, 3064, 3067, 3075	Telepiu	3057
Venturer	2199				3006, 3008, 3016, 3026, 3037, 3041, 3050, 3064, 3067, 3075	Thomson	3000, 3009
Viewmaster	2318				3006, 3008, 3016, 3026, 3037, 3041, 3050, 3064, 3067, 3075	TIME WARNER	3006
Vocostar	2157				3006, 3008, 3016, 3026, 3037, 3041, 3050, 3064, 3067, 3075	Tocom	3017
Waitec	2318				3006, 3008, 3016, 3026, 3037, 3041, 3050, 3064, 3067, 3075	Torx	3067
Welltech	2300				3006, 3008, 3016, 3026, 3037, 3041, 3050, 3064, 3067, 3075	Toshiba	3040
Westinghouse	2109, 2168				3006, 3008, 3016, 3026, 3037, 3041, 3050, 3064, 3067, 3075	Tristar	3045
Wharfedale	2304, 2305				3006, 3008, 3016, 3026, 3037, 3041, 3050, 3064, 3067, 3075	Tudi	3052
					3006, 3008, 3016, 3026, 3037, 3041, 3050, 3064, 3067, 3075	Tusa	3026, 3041
					3006, 3008, 3016, 3026, 3037, 3041, 3050, 3064, 3067, 3075	TV86	3031
					3006, 3008, 3016, 3026, 3037, 3041, 3050, 3064, 3067, 3075	Unika	3019, 3020
					3006, 3008, 3016, 3026, 3037, 3041, 3050, 3064, 3067, 3075	United Cable	3037, 3064
					3006, 3008, 3016, 3026, 3037, 3041, 3050, 3064, 3067, 3075	Universal	3019, 3020
					3006, 3008, 3016, 3026, 3037, 3041, 3050, 3064, 3067, 3075	Universum	3049, 3051
					3006, 3008, 3016, 3026, 3037, 3041, 3050, 3064, 3067, 3075	V2	3045
					3006, 3008, 3016, 3026, 3037, 3041, 3050, 3064, 3067, 3075	Videoway	3065
					3006, 3008, 3016, 3026, 3037, 3041, 3050, 3064, 3067, 3075	View Star	3024, 3029, 3031

### Blu-ray Disc

LG	2115
Panasonic	2089, 2131, 2132
Pioneer	2134
Samsung	2035, 2127
Sharp	2142, 2143, 2144
Sony	2025
Yamaha	2018

### DVR

Bush	2060
Panasonic	2037, 2038, 2039, 2040, 2041, 2042
Philips	2061, 2062
Pioneer	2063, 2064, 2065, 2066, 2067
RCA	2059
Samsung	2035
Yamaha	2036

### DVD Recorder

Aspire	2140
Astar	2162
Broksonic	2192
Go Video	2135
Hitachi	2108
Insignia	2080
Irradio	2103
JVC	2054, 2055, 2056, 2057
LG	2107, 2115, 2141, 2188
Liteon	2121
Panasonic	2037, 2038, 2039, 2041, 2042, 2043, 2089, 2104, 2108, 2112
Philips	2090, 2096, 2097, 2126, 2193
Pioneer	2067, 2113
Pye	2194
Samsung	2034, 2082, 2138
Sansui	2027
Sanyo	2139
Sony	2022, 2023, 2024, 2085, 2086, 2087, 2102, 2128, 2129, 2130
Sylvania	2189
Toshiba	2030, 2099, 2100, 2101, 2114, 2117, 2118, 2119
Yamaha	2106

### Cable

ABC	3004, 3015, 3016, 3017, 3037, 3040, 3067, 3080, 3081
ADB	3070
Adelphia	3003



Viewmaster	3045	Condor	4074, 4090, 4137	Fuba	4074, 4083, 4090,	Lasat	4074, 4088, 4090,
Vision	3045	Connexions	4074, 4092		4092, 4093, 4101,		4100, 4133, 4134,
Visiopass	3051, 3054, 3055	Conrad	4074, 4133, 4136,		4133		4137
Vortex View	3045		4137	Galaxis	4074, 4087, 4090,	Lasonic	4062
Wittenberg	3048	Conrad Electronic	4137, 4139		4091, 4096, 4098,	Lenco	4074, 4083, 4099,
Zenith	3035, 3040, 3046	Contec	4096		4133, 4140		4133, 4137, 4139
Zentek	3044	Coolsat	4050	GE	4015, 4016, 4061,	Leng	4095
<b>Sattelite</b>							
AB Sat	4138, 4139	Cosat	4098		4151	Lennox	4098
AccessHD	4058	Coship	4063	General Instrument		Lenson	4136
ADB	4142	Crown	4089		4027, 4065	Lexus	4103
AGS	4138	Daeryung	4092	GMI	4089	LG	4053, 4057, 4099
Akai	4101, 4103	Daewoo	4107, 4139	GOI	4039	Lifesat	4074, 4090, 4134,
Alba	4083, 4084, 4085,	DDC	4085	Goldbox	4135		4139
	4086, 4108, 4139	Delega	4085	GoldStar	4099	Lifetec	4090
Aldes	4085, 4087, 4088	Dew	4096	Goodmans	4079, 4080, 4084	Lorenzen	4137
Allsat	4098, 4101, 4103	Diamond	4097	Goodmind	4061	Lorraine	4099
Allsonic	4074, 4087, 4090	Digiality	4137	Grandin	4077	Lupus	4074, 4090
Alltech	4139	Digital Stream	4059	Grothusen	4083, 4099	Luxor	4136
Alpha	4103	DIRECTV	4017, 4018, 4020,	Grundig	4084, 4086, 4093,	Lyonnaise	4102
Alpha Digital	4058		4021, 4022, 4024,		4113, 4129, 4136,	Macab	4102
Alphastar	4031		4037, 4038, 4040,	Hänsel & Gretel	4137	Magnavox	4045, 4055
Amitronica	4139		4041, 4043, 4045,	Hantor	4083, 4095	Manata	4077, 4138, 4139
Amstrad	4089, 4113, 4136,		4057, 4106, 4143,	Hanuri	4088	Manhattan	4084, 4088, 4098,
	4139		4144, 4145, 4146,	Hauptpauge	4126		4138
Anglo	4139		4147, 4148, 4149,	Heliocom	4137	Marantz	4101
Ankaro	4074, 4087, 4090,		4150, 4151, 4152,	Helium	4137	Mascom	4088
	4139	Discoverer	4153, 4154, 4155,	Hinari	4085	Maspro	4084, 4139
			4156, 4157	Hirschmann	4074, 4093, 4128,	Matsui	4138
Anttron	4083, 4086				4136, 4137, 4138	Max	4137
Apollo	4083	Discovery	4138		4095	Mediabox	4135
Armstrong	4089, 4103	Diseqc	4138	Hisawa	4066	Mediamarkt	4089
Artec	4054	Dish Network	4011, 4012, 4013,	Hisense	4066	Mediasat	4091, 4135, 4136
Asat	4101, 4103		4014, 4019, 4039,	Hitachi	4032, 4084, 4149,	Medion	4074, 4090, 4139
ASLF	4139		4064		4153	Medison	4139
Astacom	4138	Dishpro	4039, 4064	Homecast	4005, 4006, 4007	Mega	4101, 4103
Astra	4089, 4091, 4100,	Distrisat	4103	Houston	4098	Memorex	4045
	4137, 4139	Ditristrad	4098	HTS	4039	Metronic	4077, 4078, 4083,
Astro	4074, 4086, 4088,	DNT	4092, 4101, 4103	Hughes	4018, 4022, 4144,		4086, 4087, 4088,
	4090, 4093, 4135,	Drake	4026		4146, 4150, 4152		4139
	4136, 4137	DStv	4140	Hughes Network Systems		Metz	4093
AudioTon	4086, 4098	Dune	4074		4021	Micro electronic	4136, 4137, 4139
Aurora	4140	Echostar	4011, 4019, 4039,	Humax	4051, 4075, 4076,	Micro Technology	4139
Austar	4140		4064, 4092, 4139		4110	MicroGem	4056
Axiel	4138	Einhell	4083, 4087, 4089,	Huth	4087, 4089, 4094,	Micromaxx	4074, 4090
Axis	4074, 4090, 4091,		4136, 4139		4095, 4096, 4098,	Microstar	4090
	4096	Elap	4138, 4139	Hypson	4137, 4141	Microtec	4139
Best	4074, 4090	Elekta	4088	Ilo	4077	Minerva	4093
Blaupunkt	4093	Elsat	4139	Imex	4066	Mitsubishi	4084, 4093, 4152
Blue Sky	4139	Elta	4074, 4083, 4090,	Innovation	4077	Mitsumi	4100
Boca	4089, 4100, 4105,		4098, 4101, 4103	Insighnia	4090	Morgan's	4089, 4100, 4101,
	4139	Emanon	4083	Intertronic	4057		4103, 4139
Boston	4138	Emme Esse	4074, 4090	Intervision	4089	Motorola	4008, 4009, 4010,
Brain Wave	4095	Engel	4139	ITT Nokia	4098, 4137		4065
Broadcast	4094	Ep Sat	4084	Jerrold	4084	Multichoice	4140
Broco	4139	EURIEULT	4077	Jerrolld	4065	Multitec	4134
BSkyB	4113, 4123	Eurodec	4102	Johansson	4095	Muratto	4099
BT	4138	Europa	4103, 4136, 4137	JOK	4138	Mysat	4139
Bubu Sat	4139	Europhon	4137	JSR	4098	Navex	4095
Bush	4084, 4127	Eurosat	4089	JVC	4011, 4019, 4039,	Neuhaus	4091, 4098, 4136,
Cambridge	4136	Eurosky	4074, 4089, 4090,		4079		4137, 4139
Canal Satellite	4135		4133, 4136, 4137	Kamm	4139	Neusat	4139
Canal+	4135	Eurostar	4089, 4133, 4137	Kathrein	4093, 4101, 4103,	Next Level	4065
CaptiveWorks	4049	Eutelsat	4139		4109, 4112, 4120,	NextWave	4141
Channel Master	4060, 4085	Exator	4083, 4086		4133, 4138, 4139	Nikko	4089, 4139
Chaparral	4025	Expressvu	4039	Kathrein Eurostar	4133	Nokia	4084, 4122
CHEROKEE	4138	Fenner	4074, 4134, 4139	Klap	4138	Nordmende	4083, 4084, 4085,
Chess	4134, 4139	Ferguson	4084, 4102, 4132	Konig	4137		4088, 4102
CityCom	4084, 4133, 4137	Fidelity	4136	Kosmos	4099	Nova	4140
Clatronic	4095	Finlandia	4084	KR	4086	Novis	4095
CNT	4088	Finlux	4084	Kreiselmeyer	4093	Oceanic	4097
Comag	4000, 4001, 4002,	FinnSat	4096, 4102	K-SAT	4139	Octagon	4083, 4086, 4096
	4003, 4004	Flair Mate	4139	Kyostar	4083	Okano	4089
Commlink	4087	Foxtel	4140	L&S Electronic	4074	Optex	4098
Comtech	4096	Freecom	4083, 4099, 4136			Optus	4135, 4140, 4141
		FTEmaximal	4074, 4139				

Orbitech	4083, 4134, 4135, 4136	Satcom	4094, 4137	Tivax	4058
OSat	4086	Satec	4139	Tivo	4150
Otto Versand	4093	Satelco	4074	Tokai	4103
Pace	4084, 4093, 4113, 4121, 4125, 4138	Satford	4094	Tonna	4084, 4094, 4098, 4136, 4139
Pacific	4097	Satmaster	4094	Toshiba	4144, 4152, 4153
Packsat	4138	Satplus	4134	Triad	4099
Palcom	4085	Schneider	4090, 4134, 4138	Triasat	4136
Palladium	4089, 4136	Schwaiger	4097, 4134, 4137	Triax	4093, 4133, 4136, 4139
Palsat	4134, 4136	SCS	4133	Turnsat	4139
Panasat	4140	Seemann	4089, 4091, 4092	Tvonic	4132
Panasonic	4043, 4044, 4046, 4084, 4113, 4118, 4143, 4148	SEG	4074, 4083, 4090, 4095	Twiner	4077, 4139
Panda	4084, 4137	Seleco	4098	UEC	4140
Pansat	4047	Servi Sat	4077, 4139	Uher	4134
Patriot	4138	Siemens	4093	UltimateTV	4020
Paysat	4045	Silva	4099	Uniden	4029, 4045
PCT	4060	Skantin	4139	Unisat	4089, 4096, 4103
Philco	4055	Skardin	4091	Unitor	4095
Philips	4021, 4022, 4045, 4084, 4101, 4103, 4111, 4115, 4135, 4138, 4150, 4152, 4153, 4155, 4156	Skinsat	4136	Universum	4093, 4133, 4137
Phoenix	4096	SKR	4139	US Digital	4066
Phonotrend	4084, 4087, 4098	Skymaster	4067, 4068, 4087, 4134, 4139	Variosat	4093
Pioneer	4124, 4135	Skymax	4101, 4103	Vega	4074
Polsat	4102	SkySat	4134, 4136, 4137, 4139	Ventana	4101, 4103
Predki	4095	Skyvision	4098	Viewsat	4048
Premiere	4098, 4135	SM Electronic	4134, 4139	Visiosat	4095, 4098, 4138, 4139
Priesner	4089	Smart	4133, 4139	Voom	4065
Primestar	4030	Sony	4017, 4020, 4135	Vortec	4083
Profile	4138	SR	4089, 4100	Welltech	4134
Promax	4084	Star Choice	4065	WeTeKom	4134, 4136
Prosat	4085, 4087	Starland	4139	Wevasat	4084
Proscan	4015, 4016, 4040, 4151	Starring	4095	Wewa	4084
Protek	4097	Start Trak	4083	Winersat	4095
Proton	4066	Strong	4074, 4083, 4086, 4090, 4099, 4140	Wisi	4084, 4092, 4093, 4136, 4137
Provision	4088	STS	4033	Woorisat	4088
Quadral	4074, 4085, 4087, 4090, 4138	STVI	4077	Worldsat	4138
Quelle	4093, 4133, 4137	Sumida	4089	Xrypton	4074
Quiero	4102	Sunny Sound	4074	XSat	4139
RadioShack	4065	Sunsat	4139	Zehnder	4074, 4088, 4090, 4131, 4133
Radiola	4101, 4103	Sunstar	4074, 4089, 4100	Zenith	4052, 4057, 4145
Radix	4092, 4119	Supermax	4141	Zodiac	4086
Rainbow	4086	Tandberg	4102		
RCA	4015, 4016, 4034, 4035, 4036, 4037, 4038, 4040, 4151, 4157	Tandy	4086		
Realistic	4028	Tantec	4084		
Redpoint	4091	TCM	4090		
Redstar	4074, 4090	Techniland	4094		
RFT	4087, 4101, 4103	TechniSat	4071, 4072, 4073, 4092, 4103, 4116, 4117, 4134, 4135, 4136		
Roadstar	4139	Technology	4140		
Roch	4077	Technosat	4141		
Rover	4074, 4139	Technowelt	4137		
Saba	4088, 4133, 4137, 4138	Teco	4089, 4100		
Sabre	4084	Telanor	4085		
Sagem	4069, 4102	Telasat	4133, 4137		
Sakura	4096	Telecom	4139		
Samsung	4018, 4021, 4023, 4041, 4042, 4081, 4082, 4083, 4114, 4150, 4154	Telefunken	4067, 4083, 4138		
SAT	4085, 4136	Teleka	4086, 4089, 4092, 4136, 4137		
Sat Cruiser	4141	Telemaster	4088		
Sat Partner	4083, 4086, 4088, 4095, 4099, 4136	Telesat	4137		
Sat Team	4139	Telestar	4134, 4135, 4136		
		Televs	4084, 4136		
		Telewire	4098		
		Tempo	4141		
		Tevion	4090, 4139		
		Thomson	4070, 4084, 4102, 4104, 4130, 4133, 4135, 4137, 4138, 4139		
		Thorens	4097		
		Thorn	4084		

---

## CD

Yamaha 5000, 5013

---

## CD Recoder

Yamaha 5001

---

## MD

Yamaha 5002, 5003, 5004

---

## Tape

Yamaha 5005, 5006

---

## Tuner

Yamaha 5007, 5008, 5009, 5010, 5014, 5015, 5016, 5017, 5018

---

## USB

Yamaha 5012, 5021

---

## DOCK

Yamaha 5011, 5022

---

## LD

Yamaha 2002





© 2009 Yamaha Corporation All rights reserved.

YAMAHA CORPORATION  
Printed in China © WQ95310

The letters in circles and the numbers in squares correspond to those in the Owner's Manual.

■ **Front panel**

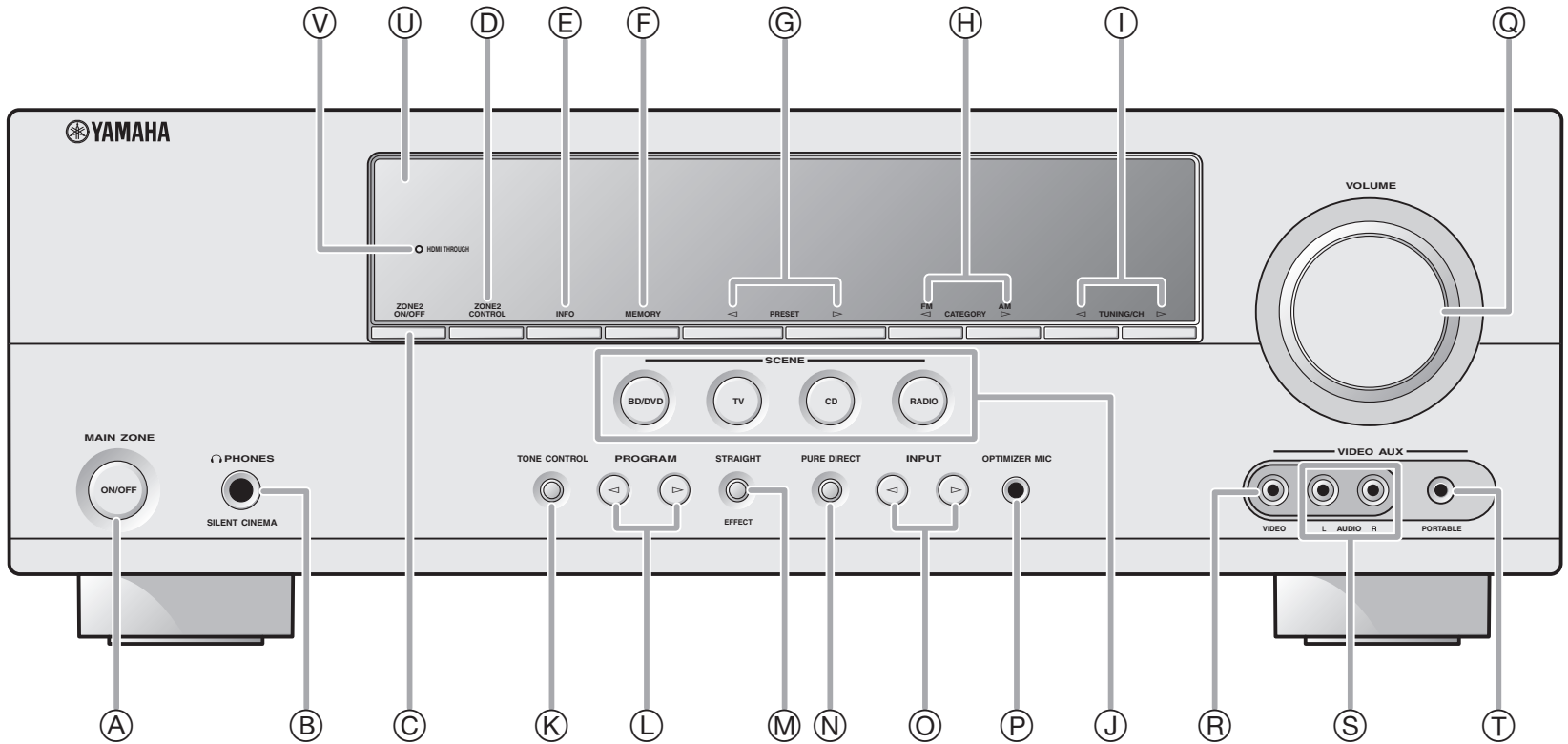

# ■ Remote control

