



Clavinova[®]

Owner's Manual
Mode d'emploi

CLP-525

English

Français

For information on assembling the keyboard stand, refer to the instructions at the end of this manual.

Pour obtenir des informations sur l'assemblage du support du clavier, reportez-vous aux instructions à la fin de ce manuel.

EN

FR

FCC INFORMATION (U.S.A.)

1. IMPORTANT NOTICE: DO NOT MODIFY THIS UNIT!

This product, when installed as indicated in the instructions contained in this manual, meets FCC requirements. Modifications not expressly approved by Yamaha may void your authority, granted by the FCC, to use the product.

2. IMPORTANT:

When connecting this product to accessories and/or another product use only high quality shielded cables. Cable/s supplied with this product MUST be used. Follow all installation instructions. Failure to follow instructions could void your FCC authorization to use this product in the USA.

3. NOTE:

This product has been tested and found to comply with the requirements listed in FCC Regulations, Part 15 for Class "B" digital devices. Compliance with these requirements provides a reasonable level of assurance that your use of this product in a residential environment will not result in harmful interference with other electronic devices. This equipment generates/uses radio frequencies and, if not installed and used according to the instructions found in the users manual, may cause interference harmful to the operation of other electronic devices. Com-

pliance with FCC regulations does not guarantee that interference will not occur in all installations. If this product is found to be the source of interference, which can be determined by turning the unit "OFF" and "ON", please try to eliminate the problem by using one of the following measures:

Relocate either this product or the device that is being affected by the interference.

Utilize power outlets that are on different branch (circuit breaker or fuse) circuits or install AC line filter/s.

In the case of radio or TV interference, relocate/reorient the antenna. If the antenna lead-in is 300 ohm ribbon lead, change the lead-in to co-axial type cable.

If these corrective measures do not produce satisfactory results, please contact the local retailer authorized to distribute this type of product. If you can not locate the appropriate retailer, please contact Yamaha Corporation of America, Electronic Service Division, 6600 Orangethorpe Ave, Buena Park, CA90620

The above statements apply ONLY to those products distributed by Yamaha Corporation of America or its subsidiaries.

* This applies only to products distributed by YAMAHA CORPORATION OF AMERICA.

(class B)

COMPLIANCE INFORMATION STATEMENT (DECLARATION OF CONFORMITY PROCEDURE)

Responsible Party : Yamaha Corporation of America
Address : 6600 Orangethorpe Ave.,
Buena Park, Calif. 90620
Telephone : 714-522-9011
Type of Equipment : Digital Piano
Model Name : CLP-525

This device complies with Part 15 of the FCC Rules. Operation is subject to the following two conditions:
1) this device may not cause harmful interference, and
2) this device must accept any interference received including interference that may cause undesired operation.
See user manual instructions if interference to radio reception is suspected.

* This applies only to products distributed by YAMAHA CORPORATION OF AMERICA. (FCC DoC)

For AC Power Adaptor

This device complies with Part 15 of the FCC Rules. Operation is subject to the following two conditions:
(1) this device may not cause harmful interference, and (2) this device must accept any interference received, including interference that may cause undesired operation.

(fcc_sengen-C)

For AC Power Adaptor

CAN ICES-3 (B)/NMB-3(B)

- This applies only to products distributed by Yamaha Canada Music Ltd.
- Ceci ne s'applique qu'aux produits distribués par Yamaha Canada Musique Ltée.

(can_b_01)

OBSERVERA!

Apparaten kopplas inte ur växelströmskällan (nätet) så länge som den är ansluten till vägguttaget, även om själva apparaten har stängts av.

ADVARSEL: Netspændingen til dette apparat er IKKE afbrudt, så længe netledningen sidder i en stikkontakt, som er tændt — også selvom der er slukket på apparatets afbryder.

VAROITUS: Laitteen toisiopiiriin kytketty käyttökytin ei irroita koko laitetta verkosta.

(standby)

IMPORTANT NOTICE FOR THE UNITED KINGDOM Connecting the Plug and Cord

IMPORTANT. The wires in this mains lead are coloured in accordance with the following code:

BLUE : NEUTRAL
BROWN : LIVE

As the colours of the wires in the mains lead of this apparatus may not correspond with the coloured markings identifying the terminals in your plug proceed as follows:

The wire which is coloured BLUE must be connected to the terminal which is marked with the letter N or coloured BLACK.

The wire which is coloured BROWN must be connected to the terminal which is marked with the letter L or coloured RED.

Making sure that neither core is connected to the earth terminal of the three pin plug.

(2 wires)

SPECIAL MESSAGE SECTION

This product utilizes batteries or an external power supply (adapter). DO NOT connect this product to any power supply or adapter other than one described in the manual, on the name plate, or specifically recommended by Yamaha.

WARNING: Do not place this product in a position where anyone could walk on, trip over, or roll anything over power or connecting cords of any kind. The use of an extension cord is not recommended! If you must use an extension cord, the minimum wire size for a 25' cord (or less) is 18 AWG. NOTE: The smaller the AWG number, the larger the current handling capacity. For longer extension cords, consult a local electrician.

This product should be used only with the components supplied or; a cart, rack, or stand that is recommended by Yamaha. If a cart, etc., is used, please observe all safety markings and instructions that accompany the accessory product.

SPECIFICATIONS SUBJECT TO CHANGE:

The information contained in this manual is believed to be correct at the time of printing. However, Yamaha reserves the right to change or modify any of the specifications without notice or obligation to update existing units.

This product, either alone or in combination with an amplifier and headphones or speaker/s, may be capable of producing sound levels that could cause permanent hearing loss. DO NOT operate for long periods of time at a high volume level or at a level that is uncomfortable. If you experience any hearing loss or ringing in the ears, you should consult an audiologist. IMPORTANT: The louder the sound, the shorter the time period before damage occurs.

Some Yamaha products may have benches and/or accessory mounting fixtures that are either supplied with the product or as optional accessories. Some of these items are designed to be dealer assembled or installed. Please make sure that benches are stable and any optional fixtures (where applicable) are well secured BEFORE using.

Benches supplied by Yamaha are designed for seating only. No other uses are recommended.

NOTICE:

Service charges incurred due to a lack of knowledge relating to how a function or effect works (when the unit is operating as designed) are not covered by the manufacturer's warranty, and are therefore the owners responsibility. Please study this manual carefully and consult your dealer before requesting service.

ENVIRONMENTAL ISSUES:

Yamaha strives to produce products that are both user safe and environmentally friendly. We sincerely believe that our products and the production methods used to produce them, meet these goals. In keeping with both the letter and the spirit of the law, we want you to be aware of the following:

Battery Notice:

This product MAY contain a small non-rechargeable battery which (if applicable) is soldered in place. The average life span of this type of battery is approximately five years. When replacement becomes necessary, contact a qualified service representative to perform the replacement.

This product may also use "household" type batteries. Some of these may be rechargeable. Make sure that the battery being charged is a rechargeable type and that the charger is intended for the battery being charged.

When installing batteries, never mix old batteries with new ones, and never mix different types of batteries. Batteries MUST be installed correctly. Mismatches or incorrect installation may result in overheating and battery case rupture.

Warning:

Do not attempt to disassemble, or incinerate any battery. Keep all batteries away from children. Dispose of used batteries promptly and as regulated by the laws in your area. Note: Check with any retailer of household type batteries in your area for battery disposal information.

Disposal Notice:

Should this product become damaged beyond repair, or for some reason its useful life is considered to be at an end, please observe all local, state, and federal regulations that relate to the disposal of products that contain lead, batteries, plastics, etc. If your dealer is unable to assist you, please contact Yamaha directly.

NAME PLATE LOCATION:

The name plate is located on the bottom of the product. The model number, serial number, power requirements, etc., are located on this plate. You should record the model number, serial number, and the date of purchase in the spaces provided below and retain this manual as a permanent record of your purchase.

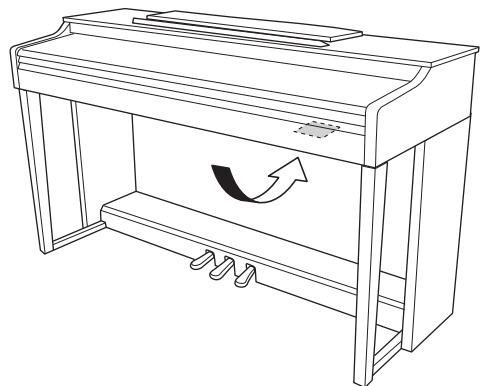

Model _____

Serial No. _____

Purchase Date _____

Table of Contents

PRECAUTIONS	5
About the Manuals	8
Included Accessories	8
Panel Controls and Terminals	9

Basic Operations

Setting Up	10
Key Cover	10
Music Rest	10
Turning the Power On.....	11
Auto Power Off.....	12
Using Headphones	12
Playing the Piano.....	13
Setting the Volume.....	13
Intelligent Acoustic Control (IAC)	13
Using the Pedals.....	14
Using the Damper Resonance	14
Using the Metronome.....	15
Changing the Touch Sensitivity	16

Advanced Operations

Playing Various Musical Instrument Sounds (Voices)	17
Selecting a Voice	17
Listening to the Demo Songs	18
Adding Variations to the Sound (Reverb)	19
Transposing the Pitch in Semitones	20
Fine-tuning the Pitch	20
Layering Two Voices (Dual mode)	21
Playing Duo	22
Song Playback and Practice	23
Listening to 50 Preset Songs.....	23
Practicing a One-Hand Part.....	24
Playing from the top of the bar including a rest or blank	24

Recording Your Performance	25
Recording Your Performance	25
Changing the Initial Settings of the Recorded Song	26
Deleting Recorded Data	26
Backing up Data and Initializing the Settings	27
Data Maintained When Power is Turned Off.....	27
Saving the User Song data to a computer	27
Transferring SMF Files Between a Computer and this Instrument.....	27
Initializing the Settings.....	27

Appendix

Troubleshooting	28
Keyboard Stand Assembly.....	29
Specifications	32
Index.....	33

PRECAUTIONS

PLEASE READ CAREFULLY BEFORE PROCEEDING

Please keep this manual in a safe and handy place for future reference.



WARNING

Always follow the basic precautions listed below to avoid the possibility of serious injury or even death from electrical shock, short-circuiting, damages, fire or other hazards. These precautions include, but are not limited to, the following:

Power supply/AC power adaptor

- Do not place the power cord near heat sources such as heaters or radiators. Also, do not excessively bend or otherwise damage the cord, or place heavy objects on it.
- Only use the voltage specified as correct for the instrument. The required voltage is printed on the name plate of the instrument.
- Use the specified adaptor (page 32) only. Using the wrong adaptor can result in damage to the instrument or overheating.
- Check the electric plug periodically and remove any dirt or dust which may have accumulated on it.

Do not open

- This instrument contains no user-serviceable parts. Do not open the instrument or attempt to disassemble or modify the internal components in any way. If it should appear to be malfunctioning, discontinue use immediately and have it inspected by qualified Yamaha service personnel.

Water warning

- Do not expose the instrument to rain, use it near water or in damp or wet conditions, place on it any containers (such as vases, bottles or glasses) containing liquids which might spill into any openings. If any liquid such as water seeps into the instrument, turn off the power immediately and unplug the power cord from the AC outlet. Then have the instrument inspected by qualified Yamaha service personnel.
- Never insert or remove an electric plug with wet hands.

Fire warning

- Do not put burning items, such as candles, on the unit. A burning item may fall over and cause a fire.

If you notice any abnormality

- When one of the following problems occur, immediately turn off the power switch and disconnect the electric plug from the outlet. Then have the device inspected by Yamaha service personnel.
 - The power cord or plug becomes frayed or damaged.
 - It emits unusual smells or smoke.
 - Some object has been dropped into the instrument.
 - There is a sudden loss of sound during use of the instrument.



CAUTION

Always follow the basic precautions listed below to avoid the possibility of physical injury to you or others, or damage to the instrument or other property. These precautions include, but are not limited to, the following:

Power supply/AC power adaptor

- Do not connect the instrument to an electrical outlet using a multiple-connector. Doing so can result in lower sound quality, or possibly cause overheating in the outlet.
- When removing the electric plug from the instrument or an outlet, always hold the plug itself and not the cord. Pulling by the cord can damage it.
- Remove the electric plug from the outlet when the instrument is not to be used for extended periods of time, or during electrical storms.

Assembly

- Read carefully the attached documentation explaining the assembly process. Failure to assemble the instrument in the proper sequence might result in damage to the instrument or even injury.

Location

- Do not place the instrument in an unstable position where it might accidentally fall over.
- When transporting or moving the instrument, always use two or more people. Attempting to lift the instrument by yourself may damage your back, result in other injury, or cause damage to the instrument itself.
- Before moving the instrument, remove all connected cables, to prevent damage to the cables or injury to anyone who might trip over them.
- When setting up the product, make sure that the AC outlet you are using is easily accessible. If some trouble or malfunction occurs, immediately turn off the power switch and disconnect the plug from the outlet. Even when the power switch is turned off, electricity is still flowing to the product at the minimum level. When you are not using the product for a long time, make sure to unplug the power cord from the wall AC outlet.
- Use only the stand specified for the instrument. When attaching the stand or rack, use the provided screws only. Failure to do so could cause damage to the internal components or result in the instrument falling over.

Connections

- Before connecting the instrument to other electronic components, turn off the power for all components. Before turning the power on or off for all components, set all volume levels to minimum.
- Be sure to set the volumes of all components at their minimum levels and gradually raise the volume controls while playing the instrument to set the desired listening level.

Handling caution

- Do not insert a finger or hand in any gaps on the key cover or instrument. Also take care that the key cover does not pinch your finger.
- Never insert or drop paper, metallic, or other objects into the gaps on the key cover, panel or keyboard. This could cause physical injury to you or others, damage to the instrument or other property, or operational failure.
- Do not rest your weight on, or place heavy objects on the instrument, and do not use excessive force on the buttons, switches or connectors.

- Do not use the instrument/device or headphones for a long period of time at a high or uncomfortable volume level, since this can cause permanent hearing loss. If you experience any hearing loss or ringing in the ears, consult a physician.

Using the bench (If included)

- Do not place the bench in an unstable position where it might accidentally fall over.
- Do not play carelessly with or stand on the bench. Using it as a tool or stepladder or for any other purpose might result in accident or injury.
- Only one person should sit on the bench at a time, in order to prevent the possibility of accident or injury.
- If the bench screws become loose due to extensive long-term use, tighten them periodically using the included tool.
- Keep special watch over any small children so that they don't fall off the rear of the bench. Since the bench does not have a backrest, unsupervised use may result in accident or injury.

Yamaha cannot be held responsible for damage caused by improper use or modifications to the instrument, or data that is lost or destroyed.

Always turn the power off when the instrument is not in use.

Even when the [] (Standby/On) switch is in standby status (power lamp is off), electricity is still flowing to the instrument at the minimum level.

When you are not using the instrument for a long time, make sure you unplug the power cord from the wall AC outlet.

NOTICE

To avoid the possibility of malfunction/damage to the product, damage to data, or damage to other property, follow the notices below.

■ Handling

- Do not use the instrument in the vicinity of a TV, radio, stereo equipment, mobile phone, or other electric devices. Otherwise, the instrument, TV, or radio may generate noise. When you use the instrument along with the application on your iPhone/iPad, we recommend that you set "Airplane Mode" to "ON" on your iPhone/iPad in order to avoid noise caused by communication.
- Do not expose the instrument to excessive dust or vibrations, or extreme cold or heat (such as in direct sunlight, near a heater, or in a car during the day) to prevent the possibility of panel disfiguration, damage to the internal components or unstable operation. (Verified operating temperature range: 5° – 40°C, or 41° – 104°F.)
- Do not place vinyl, plastic or rubber objects on the instrument, since this might discolor the panel or keyboard.
- In the case of a model with a polished finish, bumping the surface of the instrument with metal, porcelain, or other hard objects can cause the finish to crack or peel. Use caution.

■ Instrument/Bench Maintenance

To keep your Clavinova in optimum condition, we recommend that you periodically follow the maintenance points below.

- When cleaning the instrument or bench, use a soft, dry or slightly damp cloth. Do not use paint thinners, solvents, cleaning fluids, or chemical-impregnated wiping cloths. Otherwise, it may become discolored or degraded.
- If you are using a model with a polished finish, gently remove dust and dirt with a soft cloth. Do not wipe too hard since small particles of dirt can scratch the instrument's finish. To keep the surface polished, apply commercially available piano polisher to a soft cloth and wipe the instrument's surface with it. Then, polish it with a separate cloth. Before using any piano polisher, make sure to read the instructions for proper usage.
- During extreme changes in temperature or humidity, condensation may occur and water may collect on the surface of the instrument. If water is left, the wooden parts may absorb the water and be damaged. Make sure to wipe any water off immediately with a soft cloth.
- As with an acoustic piano, pedals may become tarnished across the ages. When this occurs, polish the pedal with a compound designed for piano pedals. Before using the compound, make sure to read the instructions for proper usage.

■ Saving data

- Saved data may be lost due to malfunction or incorrect operation. Save important data to an external device such as a computer (see the online manual, Computer-related Operations (page 8)).

Information

■ About copyrights

- Copying of the commercially available musical data including but not limited to MIDI data and/or audio data is strictly prohibited except for your personal use.
- This product incorporates and bundles computer programs and contents in which Yamaha owns copyrights or with respect to which it has license to use others' copyrights. Such copyrighted materials include, without limitation, all computer software, style files, MIDI files, WAVE data, musical scores and sound recordings. Any unauthorized use of such programs and contents outside of personal use is not permitted under relevant laws. Any violation of copyright has legal consequences. DON'T MAKE, DISTRIBUTE OR USE ILLEGAL COPIES.

■ About functions/data bundled with the instrument

- Some of the preset songs have been edited for length or arrangement, and may not be exactly the same as the original.

■ About this manual

- The illustrations as shown in this manual are for instructional purposes only, and may appear somewhat different from those on your instrument.
- The company names and product names in this manual are the trademarks or registered trademarks of their respective companies.

■ Tuning

- Unlike an acoustic piano, this instrument does not need to be tuned by an expert (although the pitch can be user-adjusted to match other instruments). This is because the pitch of digital instruments is always maintained perfectly.

About audio files

This instrument does not feature audio file playback or audio recording. In addition, audio signals created via your keyboard performance are not transmitted to your computer or iPad/iPhone, even if one of them is connected to the [USB TO HOST] terminal of the instrument.

Thank you for choosing the Yamaha Clavinova.

In order to make the most of the performance potential and features of the instrument, please read the manuals thoroughly, and keep them in a handy place for later reference.

About the Manuals

This instrument has the following manuals.

■ Included Manuals



Owner's Manual (this book)

Explains how to use the instrument.



Quick Operation Guide (separate sheet)

Shows in chart form the functions assigned to the buttons and the keyboard for quick understanding.

■ Online Manuals (PDF)



Computer-related Operations

Includes instructions on connecting this instrument to a computer, and operations related to transferring song data.



MIDI Reference

Contains the MIDI Data Format and MIDI Implementation chart, as well as descriptions on MIDI functions such as MIDI channel and Local Control settings.



MIDI Basics (only in English, French and German)

Contains basic explanations about MIDI.

To obtain these manuals, access the Yamaha Downloads website, select your country, enter "CLP-525" in the Model Name box, then click [SEARCH].

Yamaha Downloads

<http://download.yamaha.com/>

Included Accessories

- Owner's Manual (this book)
- Quick Operation Guide (separate sheet)
- "50 Greats for the Piano" (music book)
- Online Member Product Registration ^{*1}
- AC power adaptor ^{*2}
- Power cord ^{*2}
- Bench ^{*2}

*1 You will need the PRODUCT ID on the sheet in order to fill out the User Registration form.

*2 May not be included depending on your particular area. Please check with your Yamaha dealer.

Panel Controls and Terminals

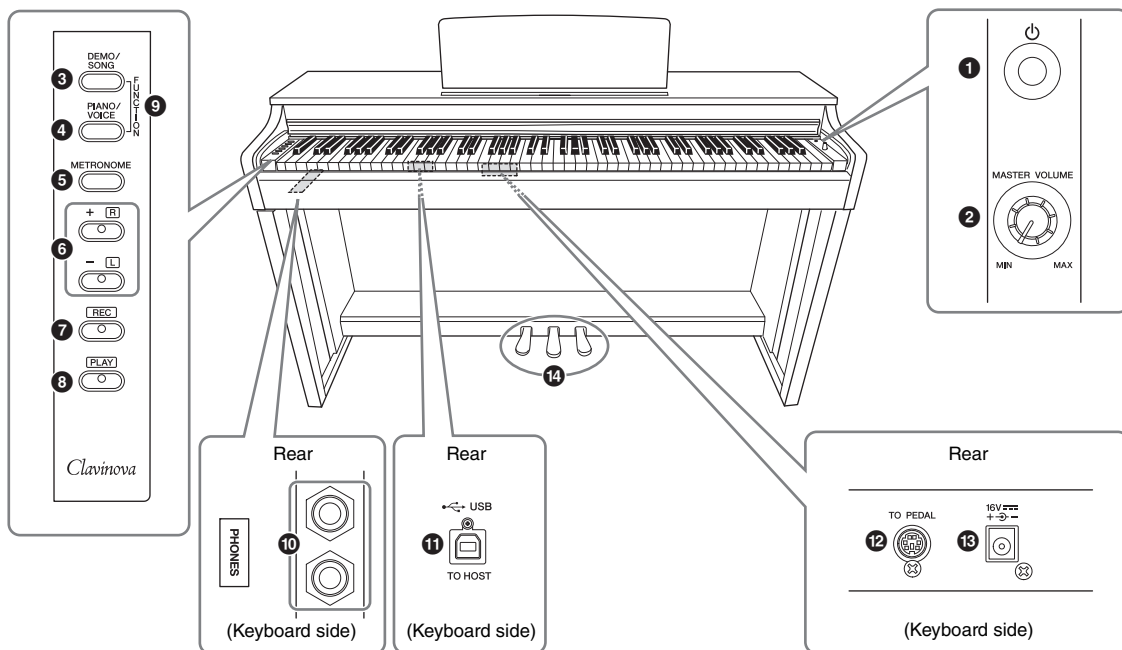

- 1 [⏻] (Standby/On) switch..... page 11**
For turning the power on or setting to standby.
- 2 [MASTER VOLUME] knob page 13**
For adjusting the volume of the entire sound.
- 3 [DEMO/SONG] button..... pages 18, 23**
For playing the Demo Songs and the Preset Songs.
- 4 [PIANO/VOICE] button..... pages 17, 19, 21**
For selecting a single Voice, two Voices for layering or a Reverb Type.
- 5 [METRONOME] button page 15**
For starting or stopping the metronome.
- 6 [+R], [-L] buttons pages 17, 20, 24**
 - In general, these are for selecting the next or previous Voice.
 - During Song playback, these are for selecting the next or previous Song, and (while holding down [PLAY]) turning on/off the right-hand and left-hand Parts individually.
 - During Metronome playback, these are for increasing or decreasing the Tempo.
- 7 [REC] button..... page 25**
For recording your keyboard performance.
- 8 [PLAY] button..... page 25**
For playing back the recorded performance.

- 9 [FUNCTION] page 20**
Simultaneously holding these two buttons and pressing the specified key sets will set the MIDI or Transpose parameters.
- 10 [PHONES] jacks..... page 12**
For connecting a set of standard stereo headphones.
- 11 [USB TO HOST] terminal**
For connecting to a computer. For details, refer to the “Computer-related Operations” on the website (page 8).
NOTICE
Use an AB type USB cable of less than 3 meters. USB 3.0 cables cannot be used.
- 12 [TO PEDAL] jack..... page 30**
For connecting the pedal cord.
- 13 DC IN jack..... page 11**
For connecting the power adaptor.
- 14 Pedals page 14**
For controlling expression and sustain, just as on an acoustic piano.

Setting Up

Key Cover

To open the key cover:

Lift the cover slightly, then push and slide it to the end.

To close the key cover:

Slide the cover toward you and gently lower the cover over the keys.

⚠ CAUTION

- Hold the cover with both hands when opening or closing it. Do not release it until it is fully opened or closed. Be careful to avoid catching fingers (yours or others, especially children's) between the cover and the main unit.
- Do not place objects, such as a piece of metal or paper, on top of the key cover. Small objects placed on the key cover may fall inside the unit when the cover is opened and may be nearly impossible to remove. This could cause electric shock, short circuit, fire or other serious damage to the instrument.

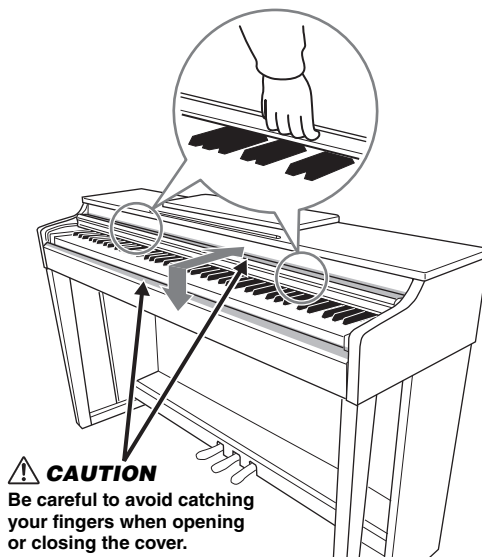

Music Rest

To raise the music rest:

1. Pull the music rest up and toward yourself as far as it will go.
2. Flip down the two metal supports at the left and right on the rear of the music rest.
3. Lower the music rest so that it rests on the metal supports.

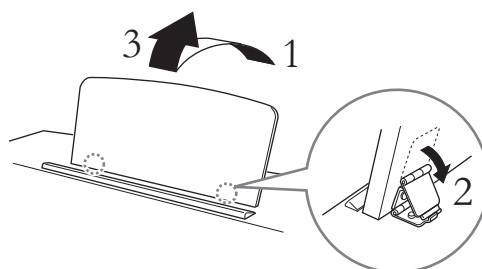

To lower the music rest:

1. Pull the music rest toward yourself as far as it will go.
2. Raise the two metal supports (at the rear of the music rest).
3. Gently lower the music rest backward until it is all the way down.

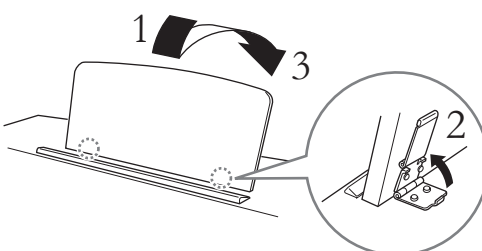

⚠ CAUTION

Do not try to use the music rest in a half-raised position. When lowering the music rest, do not release your hands from the music rest until it is all the way down.

Turning the Power On

1. Connect the plugs of the AC power adaptor in the order shown in the illustration.

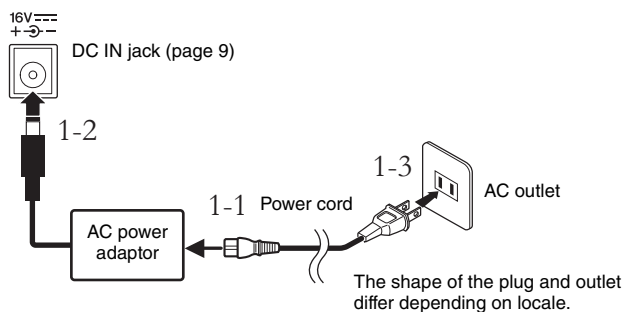

⚠ WARNING

- Use the specified adaptor (page 32) only. The use of other adaptors may result in irreparable damage to both the adaptor and the instrument.
- The AC power adaptor is designed for indoor use only. Do not use in any wet environments.

⚠ CAUTION

Remove the AC plug from the AC outlet when the instrument is not to be used for extended periods of time, or during electrical storms.

NOTE

Follow this procedure in reverse order when disconnecting the power adaptor.

2. Press the [⏻] (Standby/On) switch to turn the power on.

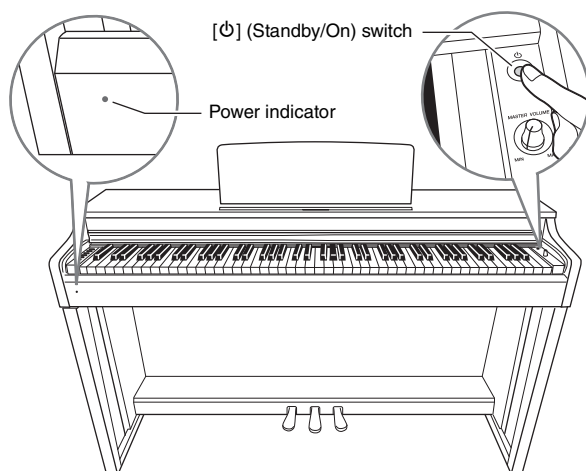

Power indicator

If you close the key cover without turning the power to standby, the power indicator remains lit, indicating that the power is still on.

When you're ready to turn the power to standby, press the [⏻] (Standby/On) switch again for a second. The power indicator turns off.

⚠ CAUTION

Even when the [⏻] (Standby/On) switch is in the standby status, electricity is still flowing to the instrument at a minimum level. When not using the instrument for an extended period of time, be sure to unplug the power cord from the wall AC outlet.

Auto Power Off

To prevent unnecessary power consumption, this instrument features an Auto Power Off function that automatically turns the power off if the instrument is not operated for approximately 30 minutes. If you do not want to use the Auto Power Off function, disable the function as described below. The setting (disabled or enabled) is retained even if the power is turned off.

Default setting:
Enable

Disabling Auto Power Off

Turn the power of the instrument off. Then, while holding down the lowest key, press the [⏻] (Standby/On) switch to turn on the power again so that the [REC] indicator flashes three times, indicating that the Auto Power Off function has been disabled.

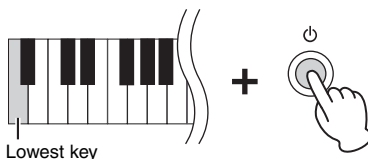

You can also disable the Auto Power Off function without turning the power off, by simultaneously holding down [DEMO/SONG] and [PIANO/VOICE] and pressing the A#5 key.

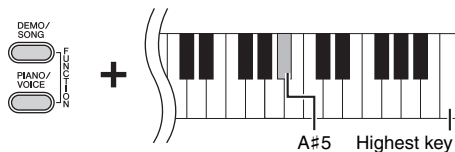

Re-enabling Auto Power Off

To enable the Auto Power Off function again, simultaneously hold down [DEMO/SONG] and [PIANO/VOICE] and press the A5 key.

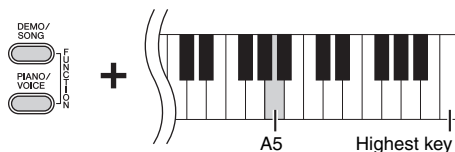

Using Headphones

Since this instrument is equipped with two [PHONES] jacks, you can connect two sets of standard stereo headphones. If you are using only one set of headphones, insert a plug into either jack, which automatically shuts off the speakers.

⚠ CAUTION

Do not use headphones at a high volume for an extended period of time; doing so may cause hearing loss.

Using the headphone hanger

You can hang the headphones on this instrument. Refer to “Keyboard Stand Assembly” on page 29 for instructions on installing the headphone hanger.

NOTICE

Do not hang anything other than the headphones on the hanger. Doing so may damage this instrument or the hanger.

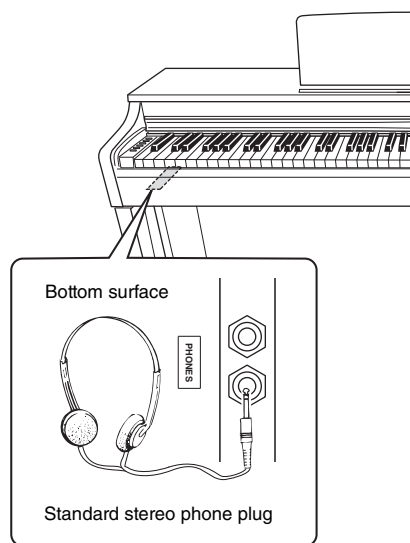

Playing the Piano

Setting the Volume

When you start playing, use the [MASTER VOLUME] knob to adjust the volume of the entire keyboard sound.

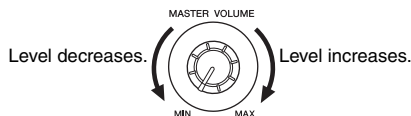

CAUTION

Do not use this instrument at a high volume level for a long period of time, or your hearing may be damaged.

Intelligent Acoustic Control (IAC)

With this function, the sound quality of this instrument is automatically adjusted and controlled according to the overall volume. Even when the volume is low, this lets you hear both low sounds and high sounds clearly.

Default setting:
On

To turn on IAC:

While holding down [PIANO/VOICE], press the F#0 key.

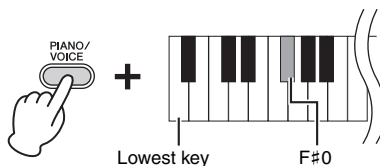

To turn off IAC:

While holding down [PIANO/VOICE], press the F0 key.

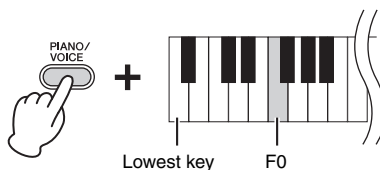

To adjust IAC Depth:

While holding down [PIANO/VOICE], press one of the A-1 – D#0 keys.

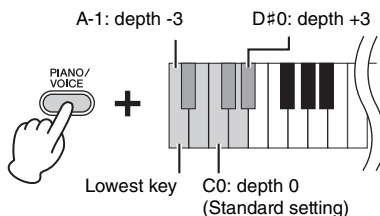

The higher the value, the more clearly that low and high sounds are heard at lower volume levels.

Setting range:
A-1 (-3) – D#0 (+3)

Default setting:
C0 (0)

Using the Pedals

Damper Pedal (Right)

Pressing this pedal will sustain notes longer. Releasing this pedal immediately stops (damps) any sustained notes. This pedal also features a “half-pedal” function that creates partial sustain effects, depending on how far down you press the pedal.



When you press the damper pedal here, this note and the notes you play before you release the pedal sustain longer.

NOTE

If the damper pedal doesn't work, make sure that the pedal cord is properly plugged into the main unit (page 30).

Half-pedal function

This function allows you to vary the sustain length depending on how far the pedal is pressed. The farther down you press the pedal, the more the sound sustains. For example, if you press the damper pedal and all notes you are playing sound a bit murky and loud with too much sustain, you can release the pedal half way or higher to decrease the sustain (murkiness).

NOTE

While the sostenuto pedal is held, the organ and strings Voices sound continuously without decay after the notes have been released.

Sostenuto Pedal (Center)

Pressing this pedal while holding the notes will sustain the pressed notes (as if the Damper Pedal had been pressed), but all subsequently played notes will not be sustained. This makes it possible to sustain a chord or single low note, for example, while the other notes are played “staccato.”

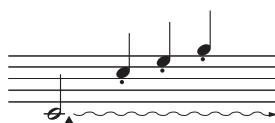

When you press the sostenuto pedal here while holding the note, the note will sustain as long as you hold the pedal.

Soft Pedal (Left)

Pressing this pedal will reduce the volume and slightly change the timbre of the notes. The notes played before this pedal is pressed are not affected. When you select the Jazz Organ Voice, pressing the left pedal switches between fast/slow rotation of the rotary speaker (page 17).

Using the Damper Resonance

The Damper Resonance effect simulates the sustain sound of the damper pedal on a grand piano, as if you were pressing the damper pedal and playing the keyboard. This effect is applied to the entire sound of the instrument.

To turn on the Damper Resonance:

While holding [PIANO/VOICE], press the G#2 key.

To turn off the Damper Resonance:

While holding [PIANO/VOICE], press the G2 key.

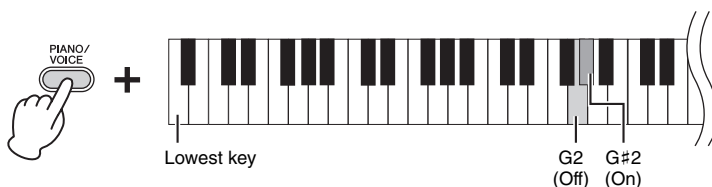

Default setting:

On

Using the Metronome

The metronome feature is convenient for practicing with an accurate tempo.

1. Press [METRONOME] to start the Metronome.
2. Press [METRONOME] to stop the Metronome.

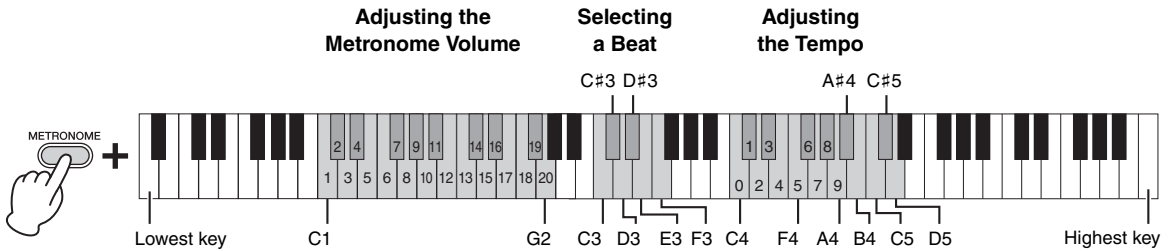

Selecting a Beat

While holding down [METRONOME], press one of the C3 – F3 keys.

Key	Beat
C3	0
C#3	2
D3	3
D#3	4
E3	5
F3	6

Adjusting the Tempo

The Metronome tempo can be set from 5 to 280 beats per minute.

- **To increase or decrease the value by 1:**

While the metronome is playing, press [+R] to increase or [-L] to decrease. Alternatively, press and hold down [METRONOME], and press the C#5 key to increase or B4 key to decrease.

- **To increase or decrease the value by 10:**

While holding down [METRONOME], press the D5 key to increase or the A#4 key to decrease.

- **To specify a three-digit value:**

While holding down [METRONOME], press the relevant C4 – A4 keys one by one in order. For example to specify “95,” press the C4 (0), A4 (9) and F4 (5) keys in order.

Resetting the value to the default (120)

While holding down [METRONOME], press the [+R] and [-L] simultaneously, or press the C5 (default) key.

Adjusting the Volume

While holding down [METRONOME], press one of the keys between C1 and G2 to set the volume of the metronome. Pressing a higher key results in higher volume, while pressing a lower key results in lower volume.

Default setting:
0 (C3)

Setting range:
C1 (1) – G2 (20)

Default setting:
D2 (15)

Changing the Touch Sensitivity

You can specify the Touch Sensitivity (how the sound responds to the way you play the keys).

While holding down [PIANO/VOICE], press one of the A6 – C7 keys.

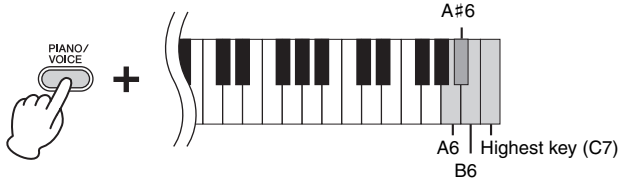

NOTE

This setting is disabled with some Voices, such as an organ sound.

Default setting:

B6 (Medium)

Key	Touch Sensitivity	Description
A6	Fixed	The volume level does not change at all regardless of whether you play the keyboard soft or hard.
A#6	Soft	The volume level does not change much when you play the keyboard soft or hard.
B6	Medium	This is the standard piano touch response.
C7	Hard	The volume level changes very widely from pianissimo to fortissimo to facilitate dynamic and dramatic expression. You have to hit the keys hard to produce a loud sound.

Playing Various Musical Instrument Sounds (Voices)

Selecting a Voice

To select “Grand Piano 1”:

Simply press [PIANO/VOICE].

To select another Voice:

After pressing [PIANO/VOICE], press [+R] or [-L] to select the next or previous Voice.

To select a specific Voice:

While holding down [PIANO/VOICE], press one of the C1 – A1 keys. For details on which Voice is assigned to each key, see the list below.

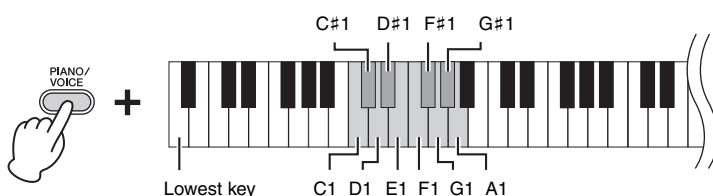

NOTE

To hear the characteristics of the Voices, play back the Demo Songs (page 18).

Voice List

Key	Voice Name	Voice description
C1	Grand Piano 1	This sound was sampled from a full concert grand piano. It uses different samples depending on the strength of your playing and produces smoother tonal changes. Suitable not only for classical compositions but also for piano pieces of any style.
C#1	Grand Piano 2	Warm and soft piano sound. Good for playing ballads.
D1	Grand Piano 3	Spacious and clear piano with bright reverb. Good for popular music.
D#1	E.Piano 1	An electronic piano sound created by FM synthesis. Good for standard popular music.
E1	E.Piano 2	The sound of an electric piano using hammer-struck metallic “tines.” Soft tone when played lightly, and an aggressive tone when played hard.
F1	Harpsichord	The definitive instrument for baroque music. Since harpsichord uses plucked strings, there is no touch response. There is, however, a characteristic additional sound when the keys are released.
F#1	Vibraphone	Vibraphone played with relatively soft mallets. The tone becomes more metallic the harder you play.
G1	Pipe Organ	This is a typical pipe organ sound (8 feet + 4 feet + 2 feet). Good for sacred music from the Baroque period.
G#1	Jazz Organ	The sound of a “tonewheel” type electric organ. Often heard in jazz and rock music. The rotary speed of the rotary speaker effect can be switched by using the left pedal.
A1	Strings	Stereo-sampled, large-scale strings ensemble with realistic reverb. Try combining this Voice with piano in the Dual mode.

Listening to the Demo Songs

Special individual Demo Songs are provided for all of the instrument Voices.

1. Press [DEMO/SONG] to start playback.

The [PLAY] lamp flashes, and the Demo Song for the current Voice starts. Starting with the selected song, the playback of the Demo Songs will continue. After the last demo song, the sequence then returns to the first Demo Song and repeats until you stop it.

To change the Demo Song during playback:

Press the [+R] or [-L] to change to the next or previous Demo Song. To change to a specific Demo Song, press and hold down the [DEMO/SONG], then press one of the C1 – A1 keys.

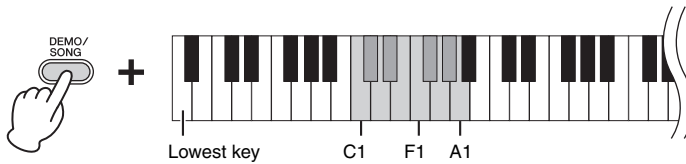

NOTE

If you want to change the playback tempo, see page 15.

2. Press [DEMO/SONG] or [PLAY] to stop playback.

The [PLAY] lamp turns off.

Demo Song List

Key	Voice Name	Title	Composer
C1	Grand Piano 1	Bargarolle op. 60	F. F. Chopin
C#1	Grand Piano 2	Von fremden Landern und Menchen, Kinderszenen op. 15-1	R. Schumann
D1	Grand Piano 3	Original	Original
D#1	E.Piano 1	Original	Original
E1	E.Piano 2	Original	Original
F1	Harpsichord	Concerto a cembalo obbligato, 2 violini, viola e continuo No. 7, BWV. 1058	J. S. Bach
F#1	Vibraphone	Original	Original
G1	Pipe Organ	Herr Christ, der ein'ge Gottes-Sohn, BWV. 601	J. S. Bach
G#1	Jazz Organ	Original	Original
A1	Strings	Original	Original

The Demo Songs excluding original Songs are short rearranged excerpts from the original compositions. The original Demo Songs are Yamaha originals (©2013 Yamaha Corporation).

Transposing the Pitch in Semitones

You can shift the pitch of the entire keyboard up or down in semitones in order to facilitate playing in difficult key signatures, or to easily match the pitch of the keyboard to the range of a singer or other instruments. For example, if “+5” is selected, playing key C produces pitch F, letting you play a song of F major as though it were in C major.

To transpose the pitch down:

While holding down [DEMO/SONG] and [PIANO/VOICE], press a key between F#2 (-6) and B2 (-1).

To transpose the pitch up:

While holding down [DEMO/SONG] and [PIANO/VOICE], press a key between C#3 (+1) and F#3 (+6).

To restore the normal pitch:

While holding down [DEMO/SONG] and [PIANO/VOICE], press the C3 key.

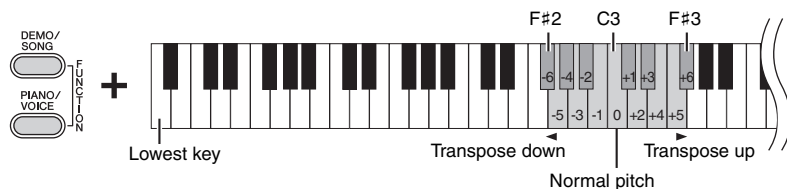

Fine-tuning the Pitch

You can fine-tune the pitch of the entire instrument in about 0.2 Hz steps. This lets you match the keyboard pitch finely to that of other instruments or CD music.

To tune up (in about 0.2 Hz steps):

Press and hold down the [DEMO/SONG] and [PIANO/VOICE] simultaneously, and press [+R].

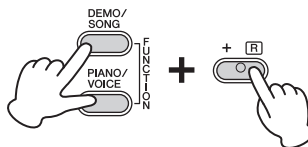

To tune down (in about 0.2 Hz steps):

Press and hold down the [DEMO/SONG] and [PIANO/VOICE] simultaneously, and press [-L].

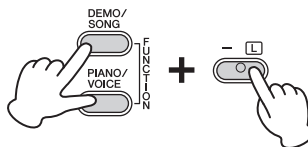

To set the pitch to 442.0 Hz:

Press and hold down the [DEMO/SONG] and [PIANO/VOICE] simultaneously, and press the A0 key.

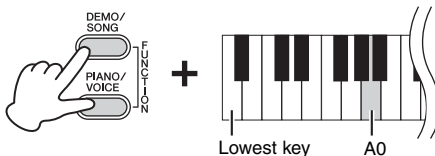

To restore default pitch:

Press and hold down the [DEMO/SONG] and [PIANO/VOICE] simultaneously, and press [+R] and [-L] simultaneously.

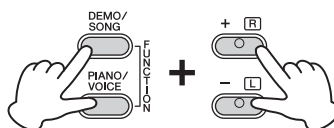

Hz (Hertz)

This unit of measurement refers to the frequency of a sound and represents the number of times a sound wave vibrates in a second.

Setting range:

414.8 – 466.8 Hz

Default setting:

A3 = 440.0 Hz

Layering Two Voices (Dual mode)

You can layer two Voices and play them simultaneously to create a more richly textured sound.

1. Engage the Dual mode.

While holding down [PIANO/VOICE], simultaneously hold down two keys between C1 and A1 to select the two desired Voices. For information on which Voices are assigned to the keys, refer to “Voice List” (page 17).

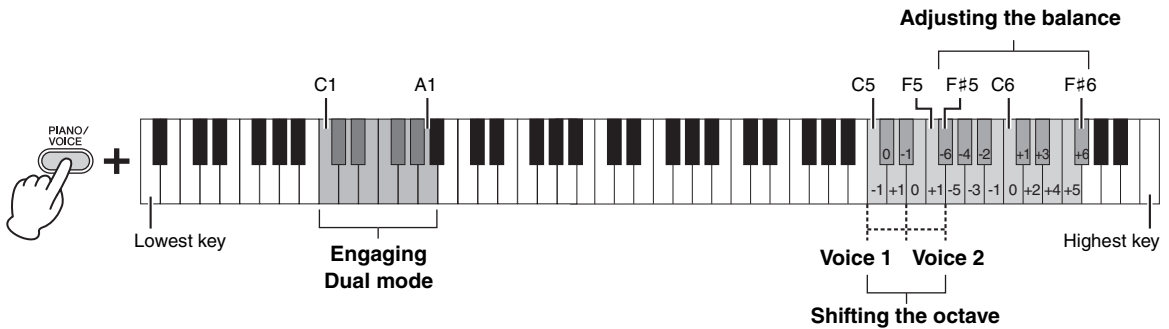

The Voice assigned to the lower key will be designated as Voice 1, and the Voice assigned to the higher key will be designated as Voice 2. You cannot assign the same Voice to both Voice 1 and Voice 2 simultaneously in Dual mode.

To shift the Octave for each Voice:

While holding down [PIANO/VOICE], press one of the C5 – F5 keys.

To adjust the Balance between two Voices:

While holding down [PIANO/VOICE], press one of the F#5 – F#6 keys. A setting of “0” produces an equal balance between two Voices. Settings below “0” increase the volume of Voice 2, while settings above “0” increase the volume of Voice 1, in relation to the other.

NOTE

The Dual and Duo modes (page 22) cannot be engaged at the same time.

2. To exit from Dual mode, press [PIANO/VOICE].

Playing Duo

This function allows two different players to play the instrument, one on the left and the other on the right, over the same octave range.

1. **While holding down [PIANO/VOICE], press [+R] and [-L] simultaneously to engage Duo.**

The keyboard is divided into two sections, with the E3 key as the Split Point.

NOTE

Different Voices cannot be assigned to the Right Voice and Left Voice.

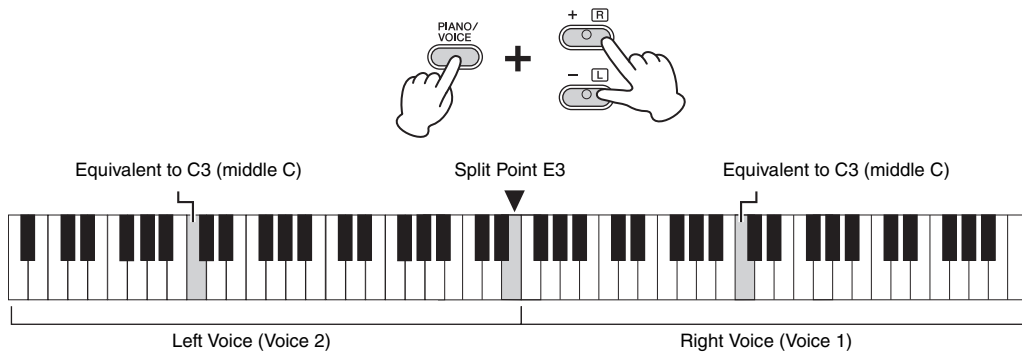

2. **One person should play the left section of the keyboard while the other plays the right.**

To shift the Octave for each Voice:

Same operation as in Dual (page 21).

To adjust the volume balance between two keyboard sections:

Same operation as in Dual (page 21).

Pedal function in Duo

Damper Pedal: Applies Sustain to the right section.

Sostenuto Pedal: Applies Sustain to both sections.

Soft Pedal: Applies Sustain to the left section.

NOTE

The Split Point cannot be changed from E3.

NOTE

If the keyboard is in Dual, engaging Duo will exit from Dual. The Voice 1 is used as the Voice of the entire keyboard.

3. **To exit from Duo, simultaneously hold down [PIANO/VOICE] and press [+R] and [-L].**

Song Playback and Practice

Listening to 50 Preset Songs

In addition to the Demo Songs, Preset Songs are provided for your listening pleasure.

1. Find the number of the Song that you want to play back from the included “50 Greats for the Piano.”

The number of each piano Preset Song is assigned to the C2 – C#6 keys.

2. While holding down [DEMO/SONG], press one of the C2 – C#6 keys to start playback.

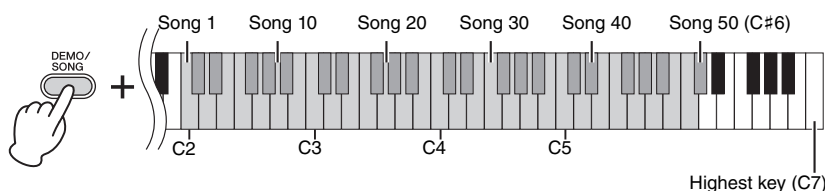

The [PLAY], [+R] and [-L] lamps light, and playback continues the sequence: starting with the selected song, the playback of the Preset Songs will continue. After the last Preset Song, the sequence then returns to the first Preset Song and repeats until you stop it.

To change the Preset Song during playback:

Press [+R] or [-L] to change to the next or previous Preset Song.

To change the tempo during playback:

Press [METRONOME] to start the Metronome, then press [+R] or [-L] to increase or decrease the Tempo value by 1. Other instructions are the same as those of the Metronome Tempo (page 15).

To play back from the beginning of the Song at the desired tempo for practice:

During playback, press [+R] and [-L] simultaneously to jump to the playback position at the beginning of the Song then continue playback at the last specified tempo.

3. Press [DEMO/SONG] or [PLAY] to stop playback.

The [PLAY], [+R] and [-L] lamps turn off.

NOTE

You can play the keyboard along with the preset Song. You can also change the Voice playing on the keyboard.

NOTE

You can import additional Songs by loading SMF files from a computer. For details, refer to the “Computer-related Operations” on the website (page 8).

Practicing a One-Hand Part

All the Songs except for the Demo (page 18) let you turn on or off the left-hand and right-hand Parts individually. By turning off [+R], for example, you can practice the right-hand Part while the left-hand Part is playing back, and vice versa.

1. **Select a Preset Song (page 23) or the User Song (page 25).**
2. **While holding down [PLAY], press [+R] or [-L] to turn the Part on/off.**

Pressing the same button repeatedly while holding down [PLAY] toggles playback on and off. The lamp of the button lights to indicate that the corresponding Part is on.

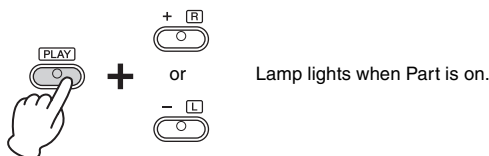

NOTE

Selecting another Song will reset the on/off status.

3. **Practice the Part which is turned off.**

To change the Tempo:

If desired, you can change the tempo for your practice convenience. For details, refer to page 15.

4. **Press [PLAY] to stop playback.**

Playing from the top of the bar including a rest or blank

This Quick Play feature enables you to specify whether a Song should play back immediately from the very first note, or play back any silence or rests that exist before the first note.

To turn on Quick Play:

Hold down [DEMO/SONG] and press the A#-1 key to enable immediate playback from the first note or first pedal operation.

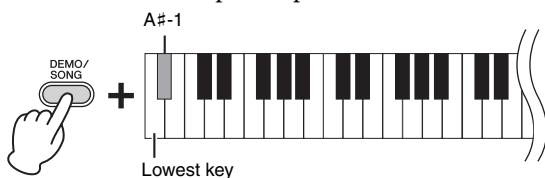

To turn off Quick Play:

Hold down [DEMO/SONG] and press the lowest key (A-1) to play from the top of the first measure (including a rest or blank).

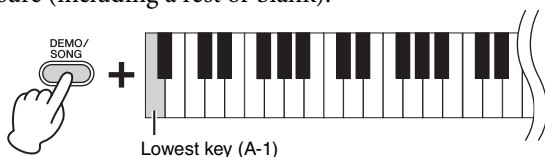

Default setting:

On

Recording Your Performance

This instrument lets you record your keyboard performance as the User Song. Up to two Parts (left-hand and right-hand) can be recorded separately.

Recording Your Performance

1. Select the desired Voice and other parameters, such as beat, for recording.

For instructions on selecting a Voice, refer to page 17. If necessary, set other parameters, such as beat and effects, in this step.

2. While holding down [REC], press [+R] or [-L] to engage Record Ready mode for the Part you want to record.

If you do not intend to record right- and left-hand Parts separately, record the entire performance to either Part.

Recording the right-hand Part ([+R])

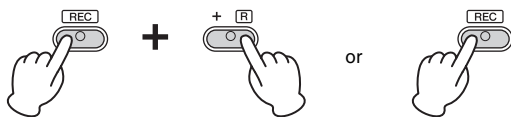

Recording the left-hand Part ([-L])

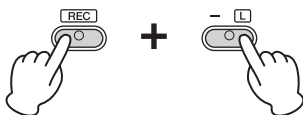

After a while, the [REC] lamp and the selected Part lamp will flash at the current tempo.

To exit from Record Ready mode:

Simply press [REC].

If data has already been recorded to the other Part:

The data in this Part will be played back while recording.

3. Play the keyboard or press [PLAY] to start recording.

The [REC] lamp lights up while the Recording Part lamp flashes at the current tempo.

4. Press either [REC] or [PLAY] to stop recording.

The [REC], [PLAY], [+R] and [-L] lamps flash, indicating that the recorded data is being stored. After the Save operation is completed, the lamps will turn off, indicating that the Record operation has been completed.

5. If desired, record the other Part by repeating Steps 1 – 4.

6. To hear the recorded Song, press [PLAY] to start playback.

Press [PLAY] again to stop playback.



About audio files

The Recording function of this instrument will record your keyboard performance as MIDI data. Note that audio recording is not available.

Recording Capacity

This instrument can record up to 100 KB (approximately 11,000 notes).

NOTE

You can use the Metronome while recording; however, the Metronome sound will not be recorded.

NOTICE

If a Part contains data, the Part lamp lights. Note that the Recording operation will replace already-recorded data with the new data.

NOTE

If the keyboard is in the Duo mode (page 22), the data will be recorded to each Part. The Part for recording cannot be specified.

NOTICE

Never turn off the power while the recorded data is being stored (while the lamps are flashing). Otherwise, all recorded data will be lost.

NOTE

The recorded Song data can be saved to a computer as a Standard MIDI file (SMF). For details, refer to the "Computer-related Operations" on the website (page 8).

Changing the Initial Settings of the Recorded Song

The settings of the following parameters can be changed after the Record operation is completed.

- For individual Parts: Voice, Dual Voices, Reverb Depth
- For the entire Song: Tempo, Reverb Type

- 1. Make the settings of the above parameters.**
- 2. While holding down [REC], press the desired Part button to engage Record Ready mode.**
In this status, do not press [PLAY] again or any key. Otherwise, the originally recorded performance data will be deleted.
- 3. Press [REC] and [PLAY] to exit from Record Ready mode.**

Deleting Recorded Data

To delete the entire Song:

- 1. While holding down [REC], press [DEMO/SONG].**
The [+R] and [-L] lamps flash.
To exit from this status, press [-L].
- 2. Press [+R] to delete the data of the entire Song.**
The [REC], [PLAY], [+R] and [-L] lamps flash.
After the operation is completed, all lamps turn off.

To delete a specific Part:

- 1. While holding down [REC], press [+R] or [-L] (depending on the Part you want to delete) to engage Record Ready mode.**
The [REC] and the selected Part ([+R] or [-L]) lamps flash.
- 2. Press [PLAY] to start recording without playing the keyboard.**
The selected Part ([+R] or [-L]) lamp flashes.
- 3. Press [REC] or [PLAY] to stop recording.**
All data recorded for the selected Part will be deleted, and the lamp turns off.

Backing up Data and Initializing the Settings

Data Maintained When Power is Turned Off

The following settings and data are maintained even if you turn the power off.

- Metronome Volume
- Metronome Beat
- Touch Sensitivity
- Tuning
- Intelligent Acoustic Control Depth
- Intelligent Acoustic Control On/Off
- Auto Power Off Enable/Disable
- User Song data
- Song data (SMF Files) loaded from a computer

Saving the User Song data to a computer

Among the data listed above, only the User Song data can be transferred to a computer and saved as an SMF file. For details, refer to the “Computer-related Operations” on the website (page 8).

NOTICE

Saved data may be lost due to malfunction or incorrect operation. Save important data to an external device such as a computer.

Transferring SMF Files Between a Computer and this Instrument

With Musicsoft Downloader (available for free downloading), up to 10 SMF files can be transferred from the computer to the internal memory of this instrument, and vice versa. For details, refer to the “Computer-related Operations” on the website (page 8).

Initializing the Settings

With this operation, all data (with the exception of the Songs) will be reset to the factory default settings.

To do this, simultaneously hold down the C7 (the highest) key and turn on the power.

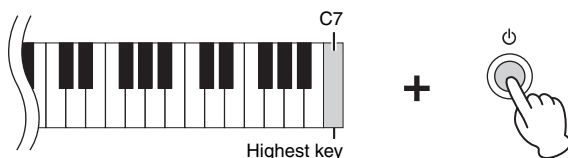

NOTICE

Never turn off the power while the Initialize operation is being executed (that is, while the [REC], [PLAY], [+R] and [-L] lamps are flashing).

NOTE

If this instrument somehow becomes disabled or malfunctions, turn off the power then execute Initialization.

Troubleshooting

Problem	Possible Cause and Solution
Power suddenly and unexpectedly turns off.	This is normal and the Auto Power Off function may have been activated (page 12). If desired, disable the Auto Power Off function.
The instrument does not turn on.	Securely insert the adaptor plugs into the socket on this instrument and into a proper AC outlet (page 11).
A click or pop is heard when the power is turned on or off.	This is normal when electrical current is being applied to the instrument.
Noise is heard from the speakers or headphones.	The noise may be due to interference caused by the use of a mobile phone in close proximity to this instrument. Turn off the mobile phone, or move it further away from this instrument.
Noise is heard from the instrument's speakers or headphones when using the instrument with the application on iPhone/iPad.	When you use the instrument along with the application on your iPhone/iPad, we recommend that you set "Airplane Mode" to "ON" on your iPhone/iPad in order to avoid noise caused by communication.
The overall volume is low, or no sound is heard.	The Master Volume is set too low. Set it to an appropriate level using the [MASTER VOLUME] knob (page 13).
	Make sure a pair of headphones is not connected to the headphones jack (page 12).
	Make sure that Local Control is On. For details, refer to the "MIDI Reference" (page 8).
Pedals do not function.	The pedal cord may not be securely connected to the [TO PEDAL] jack. Be sure to insert the pedal cord all the way until the metal part of the cord plug disappears from view (page 30).
The damper pedal does not function as expected.	The damper pedal was pressed when the power was turned on. This is not a malfunction; release the pedal and press it again to reset the function.

Keyboard Stand Assembly

⚠ CAUTION

- Assemble the unit on a hard and flat floor with ample space.
- Be careful not to confuse parts, and be sure to install all parts in the correct orientation. Please assemble the unit in accordance with the sequence given below.
- Assembly should be carried out by at least two persons.
- Be sure to use only the included screws of the specified sizes. Do not use any other screws. Use of incorrect screws can cause damage or malfunction of the product.
- Be sure to tighten all screws upon completing assembly of the unit.
- To disassemble the unit, reverse the assembly sequence given below.

Have a Phillips-head (+) screwdriver of the appropriate size ready.

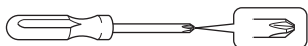

Remove all parts from the package and make sure you have all of the items.

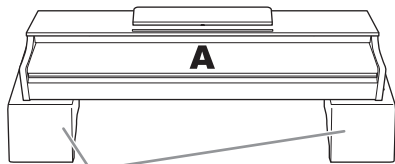

Foamed styrol pads

Remove foamed styrol pads from the package, position them on the floor, then place A on top of them. Position the pads so that they will not hide the connectors on the bottom of A.



Bundled pedal cord inside

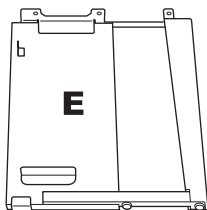
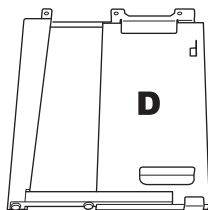

6 x 20 mm long screws x 4

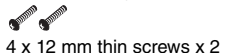

4 x 12 mm thin screws x 2



4 x 20 mm tapping screws x 4



6 x 16 mm short screws x 6



Cord holders x 2



4 x 10 mm thin screws x 2



Headphone hanger x 1

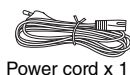

Power cord x 1



AC power adaptor x 1

The power cord and adaptor may not be included, or may look different from the illustration above, depending on your particular area. Please check with your Yamaha dealer.

1. Attach (finger-tighten) C to D and E.

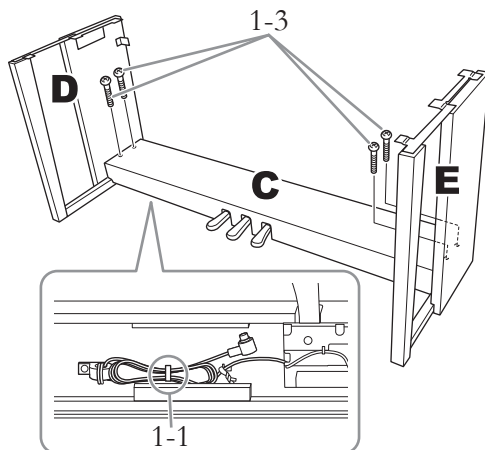

- 1-1 Untie and straighten out the bundled pedal cord.

Don't discard the vinyl tie. You will need it later in step 6.

- 1-2 Align D and E with each end of C.

- 1-3 Attach D and E to C by finger-tightening the long screws (6 x 20 mm).

2. Attach B.

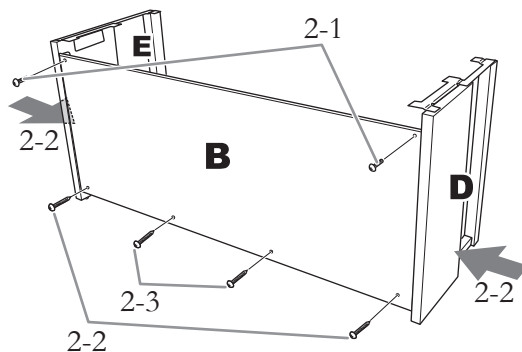

- 2-1 Align the screw holes on the upper side of B with the bracket holes on D and E, then attach the upper corners of B to D and E by finger-tightening two thin screws (4 x 12 mm).

- 2-2 While pushing the lower part of D and E from outside, secure the bottom ends of B using two tapping screws (4 x 20 mm).

2-3 Insert the other two tapping screws (4 x 20 mm) into the other two screw holes to secure B.

2-4 Securely tighten the screws on the top of B that were attached in Step 2-1.

3. Secure C.

Securely tighten the screws on C that were attached in Step 1-3.

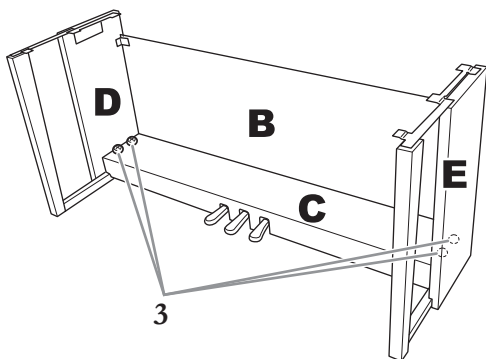

4. Mount A.

Be sure to place your hands at least 15 cm away from either end of the main unit when positioning it.

Align the screw holes.

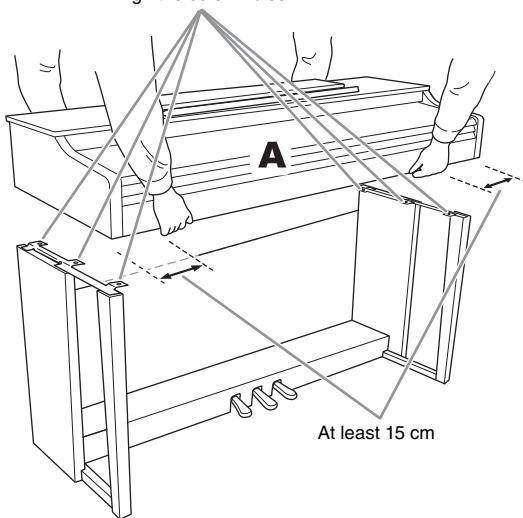

CAUTION

- Be extra careful not to drop the main unit or let your fingers be pinched by it.
- Do not hold the main unit in any position other than the position specified above.

5. Secure A.

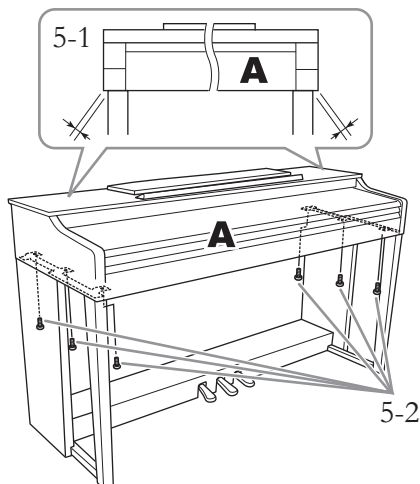

5-1 Adjust the position of A so that the left and right ends of A will project beyond D and E equally when seen from the front.

5-2 Secure A by tightening the short screws (6 x 16 mm) from the front.

6. Connect the pedal cord and the AC power adaptor.

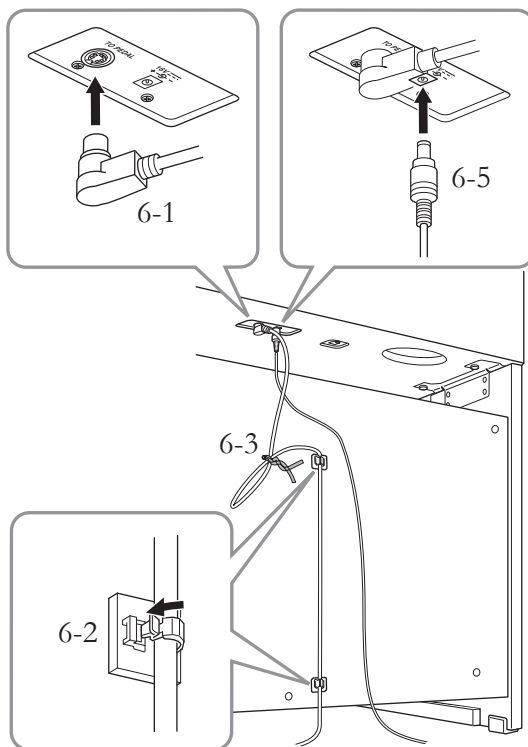

6-1 Insert the pedal cord plug to the [TO PEDAL] jack from the rear.

When connecting the pedal cord, insert the plug securely until the metal part disappears from view.

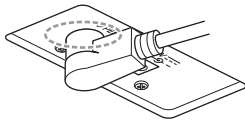

6-2 Attach the cord holders to the rear panel as shown, then clip the cord into the holders.

6-3 Use a vinyl tie to take up any slack in the pedal cord.

6-4 Connect one end of the power cord to the power adaptor.

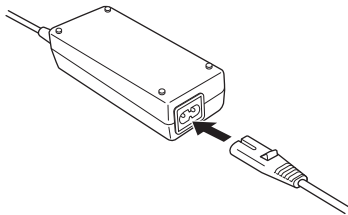

6-5 Insert the DC plug of the AC power adaptor into the DC IN jack.

7. Set the adjuster.

Rotate the adjuster until it comes in firm contact with the floor surface.

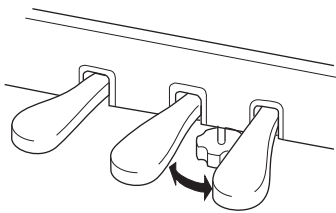

8. Attach the headphone hanger.

Use two thin screws (4 x 10 mm) to attach the hanger as shown in the illustration.

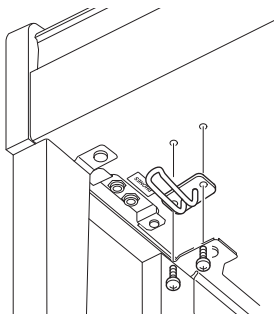

After completing the assembly, please check the following.

- **Are there any parts left over?**
→ Review the assembly procedure and correct any errors.
- **Is this instrument clear of doors and other movable fixtures?**
→ Move the instrument to an appropriate location.
- **Does this instrument make a rattling noise when you shake it?**
→ Tighten all screws.
- **Does the pedal box rattle or give way when you step on the pedals?**
→ Turn the adjuster so that it is set firmly against the floor.
- **Are the pedal cord plug and the adaptor plug inserted securely into the sockets?**
→ Check the connection.
- **If the main unit creaks or is otherwise unsteady when you play on the keyboard, refer to the assembly diagrams and retighten all screws.**

⚠ CAUTION

- When moving the instrument after assembly, always hold the bottom of the main unit.
- Do not hold the key cover or top portion. Improper handling can result in damage to the instrument or personal injury.

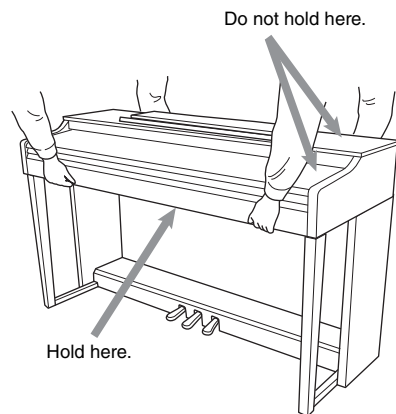

Transporting

If you move to another location, you can transport the instrument along with other belongings. You can move the unit as it is (assembled), or you can disassemble the unit down to the condition it was in when you first took it out of the box. Transport the keyboard horizontally. Do not lean it up against a wall or stand it up on its side. Do not subject the instrument to excessive vibration or shock. When transporting the assembled instrument, make sure all screws are properly tightened and have not been loosened by moving the instrument.

Specifications

Items		CLP-525	
Size/Weight	Width [For models with polished finish]	1350 mm (53-1/8") [1353 mm (53-1/4")]	
	Height [For models with polished finish]	Without Music Rest	845 mm (33-1/4") [848 mm (33-3/8")]
		With Music Rest	999 mm (39-5/16") [1000 mm (39-3/8")]
	Depth [For models with polished finish]	Without Music Rest	414 mm (16-5/16") [415 mm (16-5/16")]
With Music Rest		414 mm (16-5/16") [415 mm (16-5/16")]	
Weight [For models with polished finish]		43.0 kg (94 lbs., 13 oz) [45.0 kg (99 lbs., 3 oz)]	
Control Interface	Keyboard	Number of Keys	88
		Type	GH3 (Graded Hammer 3) keyboard with synthetic ivory keytops
		Touch Response	Hard/Medium/Soft/Fixed
	Pedal	Number of Pedals	3
		Half Pedal	Yes (Damper)
Functions		Sustain, Sostenuto, Soft	
Panel Language		English	
Cabinet	Key Cover Style	Sliding	
	Music Rest	Yes	
Voices/ Tone Generation	Piano Sound	Yamaha CFIIIS	
	Number of Polyphony (Max.)	256	
	Number of Voices	10	
Effects/Functions	Reverb	4 types	
	Smooth Release	Yes	
	Damper Resonance	Yes	
	Dual	Yes	
	Duo	Yes	
	Intelligent Acoustic Control (IAC)	Yes	
Recording/Playback (MIDI data only; audio not supported)	Preset	Number of Preset Songs	10 Demo Songs, 50 Piano Preset Songs
		Number of Songs	1
	Recording	Number of Tracks	2
		Data Capacity (Max.)	Approx. 100 KB/Song (Approx. 11,000 notes)
	Compatible Data Format	Recording	SMF (Format 0)
Playback		SMF (Format 0 & 1)	
Overall Controls	Metronome	Yes	
	Tempo Range	5 – 280	
	Transpose	-6 – 0 – +6	
	Tuning	414.8 – 440.0 – 466.8 Hz	
Storage	Internal Memory	Total maximum size approx. 900 KB (User song: One song approx. 100 KB, Loading song data from a computer: Up to 10 songs)	
Connectivity	Headphones	Yes (x 2)	
	USB TO HOST	Yes	
Sound System	Amplifiers	20 W x 2	
	Speakers	Oval (12 cm x 6 cm) x 2	
	Acoustic Optimizer	Yes	
Power Supply	Power Consumption	13 W (when using the PA-300C)	
	Auto Power Off	Yes (Approx. 30 minutes)	
Accessories	<ul style="list-style-type: none"> • Owner's Manual • Quick Operation Guide • "50 Greats for the Piano" (Music Book) • Online Member Product Registration • AC power adaptor: PA-300C or an equivalent recommended by Yamaha* • Power cord* • Bench* * Included or optional depending on your locale		
Options (May not be available depending on your locale.)		<ul style="list-style-type: none"> • USB MIDI Interface for iPhone/iPod touch/iPad: i-UX1 • Headphones: HPE-160 • AC power adaptor: PA-300C or an equivalent recommended by Yamaha 	

* Specifications and descriptions in this owner's manual are for information purposes only. Yamaha Corp. reserves the right to change or modify products or specifications at any time without prior notice. Since specifications, equipment or options may not be the same in every locale, please check with your Yamaha dealer.

Index

Numerics

50 Preset Songs23

A

AC power adaptor8

Accessories8

Auto Power Off12

B

Beat15

C

Computer-related Operations8

D

Damper Pedal14

Damper Resonance14

Delete26

Demo Song List18

Demo Songs18

Dual mode21

Duo22

H

Half-pedal14

Headphones12

Hz (Hertz)20

I

Initializing27

Intelligent Acoustic Control (IAC)13

K

Key Cover10

L

Left-hand Part24

M

Manuals8

Metronome15

MIDI Basics8

MIDI Reference8

O

Octave21

Online Manuals (PDF)8

P

Panel Controls and Terminals9

Pedals14

Pitch20

Power11

Power indicator11

Practice24

Preset Songs23

Q

Quick Operation Guide8

Quick Play24

R

Recording25

Reverb19

Reverb Depth19

Reverb Type19

Reverb Type List19

Right-hand Part24

S

Soft Pedal14

Sostenuto Pedal14

T

Tempo15

Touch Sensitivity16

Transpose20

Tuning20

U

USB TO HOST9

User Song25

V

Voice17

Voice List17

Volume13, 15

MEMO

The model number, serial number, power requirements, etc., may be found on or near the name plate, which is at the bottom of the unit. You should note this serial number in the space provided below and retain this manual as a permanent record of your purchase to aid identification in the event of theft.

Model No. _____

Serial No. _____

(bottom_en_01)

Le numéro de modèle, le numéro de série, l'alimentation requise, etc., se trouvent sur ou près de la plaque signalétique du produit, située dans la partie inférieure de l'unité. Notez le numéro de série dans l'espace fourni ci-dessous et conservez ce manuel en tant que preuve permanente de votre achat afin de faciliter l'identification du produit en cas de vol.

N° de modèle _____

N° de série _____

(bottom_fr_01)

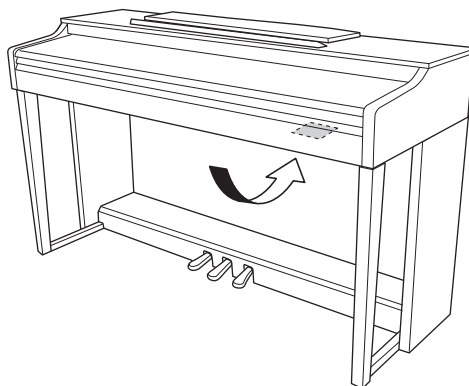

The name plate is located on the bottom of the unit.

La plaque signalétique de ce produit se trouve dans le bas de l'unité.

For CLP-525 and AC Power Adaptor

Information for Users on Collection and Disposal of Old Equipment



This symbol on the products, packaging, and/or accompanying documents means that used electrical and electronic products should not be mixed with general household waste.

For proper treatment, recovery and recycling of old products, please take them to applicable collection points, in accordance with your national legislation and the Directives 2002/96/EC.

By disposing of these products correctly, you will help to save valuable resources and prevent any potential negative effects on human health and the environment which could otherwise arise from inappropriate waste handling.

For more information about collection and recycling of old products, please contact your local municipality, your waste disposal service or the point of sale where you purchased the items.

[For business users in the European Union]

If you wish to discard electrical and electronic equipment, please contact your dealer or supplier for further information.

[Information on Disposal in other Countries outside the European Union]

This symbol is only valid in the European Union. If you wish to discard these items, please contact your local authorities or dealer and ask for the correct method of disposal.

(weee_eu_en_01)

Information concernant la Collecte et le Traitement des déchets d'équipements électriques et électroniques.



Le symbole sur les produits, l'emballage et/ou les documents joints signifie que les produits électriques ou électroniques usagés ne doivent pas être mélangés avec les déchets domestiques habituels.

Pour un traitement, une récupération et un recyclage appropriés des déchets d'équipements électriques et électroniques, veuillez les déposer aux points de collecte prévus à cet effet, conformément à la réglementation nationale et aux Directives 2002/96/EC.

En vous débarrassant correctement des déchets d'équipements électriques et électroniques, vous contribuerez à la sauvegarde de précieuses ressources et à la prévention de potentiels effets négatifs sur la santé humaine qui pourraient advenir lors d'un traitement inapproprié des déchets.

Pour plus d'informations à propos de la collecte et du recyclage des déchets d'équipements électriques et électroniques, veuillez contacter votre municipalité, votre service de traitement des déchets ou le point de vente où vous avez acheté les produits.

[Pour les professionnels dans l'Union Européenne]

Si vous souhaitez vous débarrasser des déchets d'équipements électriques et électroniques veuillez contacter votre vendeur ou fournisseur pour plus d'informations.

[Information sur le traitement dans d'autres pays en dehors de l'Union Européenne]

Ce symbole est seulement valable dans l'Union Européenne. Si vous souhaitez vous débarrasser de déchets d'équipements électriques et électroniques, veuillez contacter les autorités locales ou votre fournisseur et demander la méthode de traitement appropriée.

(weee_eu_fr_01)

Important Notice: Guarantee Information for customers in European Economic Area (EEA) and Switzerland

<p>Important Notice: Guarantee Information for customers in EEA* and Switzerland</p> <p>For detailed guarantee information about this Yamaha product, and Pan-EEA* and Switzerland warranty service, please either visit the website address below (Printable file is available at our website) or contact the Yamaha representative office for your country. * EEA: European Economic Area</p>	English
<p>Wichtiger Hinweis: Garantie-Information für Kunden in der EWR* und der Schweiz</p> <p>Für nähere Garantie-Information über dieses Produkt von Yamaha, sowie über den Pan-EWR*- und Schweizer Garantieservice, besuchen Sie bitte entweder die folgend angegebene Internetadresse (eine druckfähige Version befindet sich auch auf unserer Webseite), oder wenden Sie sich an den für Ihr Land zuständigen Yamaha-Vertrieb. *EWR: Europäischer Wirtschaftsraum</p>	Deutsch
<p>Remarque importante: informations de garantie pour les clients de l'EEE et la Suisse</p> <p>Pour des informations plus détaillées sur la garantie de ce produit Yamaha et sur le service de garantie applicable dans l'ensemble de l'EEE ainsi qu'en Suisse, consultez notre site Web à l'adresse ci-dessous (le fichier imprimable est disponible sur notre site Web) ou contactez directement Yamaha dans votre pays de résidence. * EEE : Espace Economique Européen</p>	Français
<p>Belangrijke mededeling: Garantie-informatie voor klanten in de EER* en Zwitserland</p> <p>Voor gedetailleerde garantie-informatie over dit Yamaha-product en de garantieservice in heel de EER* en Zwitserland, gaat u naar de onderstaande website (u vindt een afdrukbaar bestand op onze website) of neemt u contact op met de vertegenwoordiging van Yamaha in uw land. * EER: Europese Economische Ruimte</p>	Nederlands
<p>Aviso importante: información sobre la garantía para los clientes del EEE* y Suiza</p> <p>Para una información detallada sobre este producto Yamaha y sobre el soporte de garantía en la zona EEE* y Suiza, visite la dirección web que se incluye más abajo (la versión del archivo para imprimir esta disponible en nuestro sitio web) o póngase en contacto con el representante de Yamaha en su país. * EEE: Espacio Económico Europeo</p>	Español
<p>Avviso importante: informazioni sulla garanzia per i clienti residenti nell'EEA* e in Svizzera</p> <p>Per informazioni dettagliate sulla garanzia relativa a questo prodotto Yamaha e l'assistenza in garanzia nei paesi EEA* e in Svizzera, potete consultare il sito Web all'indirizzo riportato di seguito (è disponibile il file in formato stampabile) oppure contattare l'ufficio di rappresentanza locale della Yamaha. * EEA: Area Economica Europea</p>	Italiano
<p>Aviso importante: informações sobre as garantias para clientes da AEE* e da Suíça</p> <p>Para obter uma informação pormenorizada sobre este produto da Yamaha e sobre o serviço de garantia na AEE* e na Suíça, visite o site a seguir (o arquivo para impressão está disponível no nosso site) ou entre em contato com o escritório de representação da Yamaha no seu país. * AEE: Área Económica Europeia</p>	Português
<p>Σημαντική σημείωση: Πληροφορίες εγγύησης για τους πελάτες στον ΕΟΧ* και Ελλάδα</p> <p>Για λεπτομερείς πληροφορίες εγγύησης σχετικά με το προϊόν προϊόν της Yamaha και την κάλυψη εγγύησης σε όλες τις χώρες του ΕΟΧ και την Ελλάδα, επισκεφτείτε την παρακάτω ιστοσελίδα (Εκτυπώσιμη μορφή είναι διαθέσιμη στην ιστοσελίδα μας) ή απευθυνθείτε στην αντιπροσωπεία της Yamaha στη χώρα σας. * ΕΟΧ: Ευρωπαϊκός Οικονομικός Χώρος</p>	Ελληνικά
<p>Viktig: Garantiformasjon for kunder i EES-området* och Schweiz</p> <p>För detaljerad information om denna Yamaha-produkt samt garantiservice i hela EES-området* och Schweiz kan du antingen besöka nedanstående webbadress (en utskriftsvänlig fil finns på webbplatsen) eller kontakta Yamahas officiella representant i ditt land. * EES: Europeiska Ekonomiska Samarbetsområdet</p>	Svenska
<p>Viktig merknad: Garantiformasjon for kunder i EØS* og Sveits</p> <p>Detaljert garantiformasjon om dette Yamaha-produktet og garantiservice for hele EØS-området* og Sveits kan fås enten ved å besøke nettstedene nedenfor (utskriftsversjon finnes på våre nettsider) eller kontakte Yamahas kontorene i landet der du bor. *EØS: Det europeiske økonomiske samarbeidsområdet</p>	Norsk
<p>Vigtig oplysning: Garantiplysninger til kunder i EØO* og Schweiz</p> <p>De kan finde detaljerede garantiplysninger om dette Yamaha-produkt og den fælles garantiserviceordning for EØO* (og Schweiz) ved at besøge det websted, der er angivet nedenfor (der findes en fil, som kan udskrives, på vores websted), eller ved at kontakte Yamahas nationale repræsentationskontor i det land, hvor De bor. * EØO: Det Europæiske Økonomiske Område</p>	Dansk
<p>Tärkeä ilmoitus: Takuutiedot Euroopan talousalueen (ETA)* ja Sveitsin asiakkaille</p> <p>Tämän Yamaha-tuotteen sekä ETA-alueen ja Sveitsin takuuta koskevat yksityiskohtaiset tiedot saatte alla olevasta nettiosoitteesta. (Tulostettava tiedosto saatavissa sivustollamme.) Voitte myös ottaa yhteyttä paikalliseen Yamaha-edustajaan. *ETA: Euroopan talousalue</p>	Suomi
<p>Ważne: Warunki gwarancyjne obowiązujące w EOG* i Szwajcarii</p> <p>Aby dowiedzieć się więcej na temat warunków gwarancyjnych tego produktu firmy Yamaha i serwisu gwarancyjnego w całym EOG* i Szwajcarii, należy odwiedzić wskazaną poniżej stronę internetową (Plik gotowy do wydruku znajduje się na naszej stronie internetowej) lub skontaktować się z przedstawicielstwem firmy Yamaha w swoim kraju. * EOG — Europejski Obszar Gospodarczy</p>	Polski
<p>Důležité oznámení: Záruční informace pro zákazníky v EHS* a ve Švýcarsku</p> <p>Podrobné záruční informace o tomto produktu Yamaha a záručním servisu v celém EHS* a ve Švýcarsku naleznete na níže uvedené webové adrese (soubor k tisku je dostupný na našich webových stránkách) nebo se můžete obrátit na zastoupení firmy Yamaha ve své zemi. * EHS: Evropský hospodářský prostor</p>	Česky
<p>Fontos figyelmeztetés: Garancia-információk az EGT* területén és Svájcban élő vásárlók számára</p> <p>A jelen Yamaha termékre vonatkozó részletes garancia-információk, valamint az EGT*-re és Svájcra kiterjedő garanciális szolgáltatás tekintetében keresse fel webhelyünket az alábbi címen (a webhelyen nyomtatható fájl is talál), vagy pedig lépjen kapcsolatba az országában működő Yamaha képviseleti irodával. * EGT: Európai Gazdasági Térség</p>	Magyar
<p>Oluline märkus: Garantiteave Euroopa Majanduspiirkonna (EMP)* ja Šveitsi klientidele</p> <p>Lai saagemu detailizitu garantijas informāciju par šo Yamaha produktu, kā arī garantijas apkalpošanu EEZ* un Šveicā, lūdzam apmeklējiet zemāk norādīto tīmekļa vietnes adresi (tīmekļa failu varat izdrukāt tieši šajā vietnē) vai sazināties ar jūsu valsts apkalpojošo Yamaha pārstāvniecību. * EMP: Euroopa Majanduspiirkond</p>	Eesti keel
<p>Svarīgs paziņojums: garantijas informācija klientiem EEZ* un Šveicē</p> <p>Lai saņemtu detalizētu garantijas informāciju par šo Yamaha produktu, kā arī garantijas apkalpošanu EEZ* un Šveicā, lūdzam apmeklējiet zemāk norādīto tīmekļa vietnes adresi (tīmekļa failu varat izdrukāt tieši šajā vietnē) vai sazināties ar jūsu valsts apkalpojošo Yamaha pārstāvniecību. * EEZ: Eiropas Ekonomikas zona</p>	Latviešu
<p>Dėmesio: informacija dėl garantijos pirkėjams EEE* ir Šveicarijoje</p> <p>Jei reikia išsamios informacijos apie šį „Yamaha“ produktą ir jo techninę priežiūrą visoje EEE* ir Šveicarijoje, apsilankykite mūsų svetainėje toliau nurodytu adresu (svetainėje yra spausdinlinas failas) arba kreipkitės į „Yamaha“ atstovybę savo šalyje. *EEE – Europos ekonominė erdvė</p>	Lietuvių kalba
<p>Dôležité upozornenie: Informácie o záruke pre zákazníkov v EHP* a Švajčiarsku</p> <p>Podrobné informácie o záruke týkajúce sa tohto produktu od spoločnosti Yamaha a garancným servise v EHP* a Švajčiarsku nájdete na webovej stránke uvedenej nižšie (na našej webovej stránke je k dispozícii súbor na tlač) alebo sa obráťte na zástupcu spoločnosti Yamaha vo svojej krajine. * EHP: Európsky hospodársky priestor</p>	Slovenčina
<p>Pomembno obvestilo: Informacije o garanciji za kupce v EGP* in Švici</p> <p>Za podrobne informacije o tem Yamahinih izdelku ter garancijskem servisu v celotnem EGP in Švici, obiščite spletno mesto, ki je navedeno spodaj (natiljiva datoteka je na voljo na našem spletnem mestu), ali se obrnite na Yamahinega predstavnika v svoji državi. * EGP: Evropski gospodarski prostor</p>	Slovenščina
<p>Важно съобщение: Информация за гаранцията за клиенти в ЕИП* и Швейцария</p> <p>За подробна информация за гаранцията за този продукт на Yamaha и гаранционното обслужване в паневропейската зона на ЕИП* и Швейцария или посетете посочения по-долу уеб сайт (на нашия уеб сайт има файл за печат), или се свържете с представителния офис на Yamaha във вашата страна. * ЕИП: Европейско икономическо пространство</p>	Български език
<p>Notificare importantă: Informații despre garanție pentru clienții din SEE* și Elveția</p> <p>Pentru informații detaliate privind acest produs Yamaha și serviciul de garanție Pan-SEE* și Elveția, vizitați site-ul la adresa de mai jos (fișierul imprimabil este disponibil pe site-ul nostru) sau contactați biroul reprezentanței Yamaha din țara dumneavoastră. * SEE: Spațiul Economic European</p>	Limba română

<http://europe.yamaha.com/warranty/>

For details of products, please contact your nearest Yamaha representative or the authorized distributor listed below.

Pour plus de détails sur les produits, veuillez-vous adresser à Yamaha ou au distributeur le plus proche de vous figurant dans la liste suivante.

NORTH AMERICA

CANADA

Yamaha Canada Music Ltd.
135 Milner Avenue, Toronto, Ontario,
M1S 3R1, Canada
Tel: 416-298-1311

U.S.A.

Yamaha Corporation of America
6600 Orangethorpe Avenue, Buena Park, CA 90620,
U.S.A.
Tel: 714-522-9011

CENTRAL & SOUTH AMERICA

MEXICO

Yamaha de México, S.A. de C.V.
Av. Insurgentes Sur 1647 "Prisma Insurgentes",
Col. San Jose Insurgentes, Del. Benito Juarez,
03900, Mexico, D.F.
Tel: 55-5804-0600

BRAZIL

Yamaha Musical do Brasil Ltda.
Rua Joaquim Floriano, 913 - 4º andar, Itaim Bibi,
CEP 04534-013 São Paulo, SP. BRAZIL
Tel: 011-3704-1377

ARGENTINA

**Yamaha Music Latin America, S.A.,
Sucursal Argentina**
Olga Cossetini 1553, Piso 4 Norte,
Madero Este-C1107CEK
Buenos Aires, Argentina
Tel: 54-11-4119-7000

VENEZUELA

**Yamaha Music Latin America, S.A.,
Sucursal Venezuela**
C.C. Manzanares Plaza P4
Ofic. 0401- Manzanares-Baruta
Caracas Venezuela
Tel: 58-212-943-1877

PANAMA AND OTHER LATIN AMERICAN COUNTRIES/ CARIBBEAN COUNTRIES

Yamaha Music Latin America, S.A.
Torre Banco General, Piso No.7, Marbella,
Calle 47 y Aquilino de la Guardia,
Ciudad de Panamá, República de Panamá
Tel: +507-269-5311

EUROPE

THE UNITED KINGDOM/IRELAND

Yamaha Music Europe GmbH (UK)
Sherbourne Drive, Tilbrook, Milton Keynes,
MK7 8BL, U.K.
Tel: 01908-366700

GERMANY

Yamaha Music Europe GmbH
Siemensstraße 22-34, 25462 Rellingen, Germany
Tel: 04101-3030

SWITZERLAND/LIECHTENSTEIN

**Yamaha Music Europe GmbH
Branch Switzerland in Zürich**
Seefeldstrasse 94, 8008 Zürich, Switzerland
Tel: 044-387-8080

AUSTRIA

Yamaha Music Europe GmbH Branch Austria
Schleiergasse 20, A-1100 Wien, Austria
Tel: 01-60203900

CZECH REPUBLIC/HUNGARY/ ROMANIA/SLOVAKIA/SLOVENIA

**Yamaha Music Europe GmbH
Branch Austria (Central Eastern Europe Office)**
Schleiergasse 20, A-1100 Wien, Austria
Tel: 01-60203900

POLAND/LITHUANIA/LATVIA/ ESTONIA

**Yamaha Music Europe GmbH
Branch Poland Office**
ul. Wrotkowa 14 02-553 Warsaw, Poland
Tel: 022-500-2925

BULGARIA

Dinacord Bulgaria LTD.
Bul. Iskarsko Schose 7 Targowski Zentar Ewropa
1528 Sofia, Bulgaria
Tel: 02-978-20-25

MALTA

Olimpus Music Ltd.
The Emporium, Level 3, St. Louis Street Msida
MSD06
Tel: 02133-2144

NETHERLANDS/BELGIUM/ LUXEMBOURG

Yamaha Music Europe Branch Benelux
Clarissenhof 5-b, 4133 AB Vianen, Netherlands
Tel: 0347-358 040

FRANCE

Yamaha Music Europe
7 rue Ambroise Croizat, Zone d'activites Pariest,
77183 Croissy-Beaubourg, France
Tel: 01-64-61-4000

ITALY

Yamaha Music Europe GmbH, Branch Italy
Viale Italia 88, 20020 Lainate (Milano), Italy
Tel: 02-935-771

SPAIN/PORTUGAL

**Yamaha Music Europe GmbH Ibérica, Sucursal
en España**
Ctra. de la Coruna km. 17,200, 28231
Las Rozas (Madrid), Spain
Tel: +34-91-639-88-88

GREECE

Philippos Nakas S.A. The Music House
147 Skiathou Street, 112-55 Athens, Greece
Tel: 01-228 2160

SWEDEN

**Yamaha Music Europe GmbH Germany filial
Scandinavia**
J. A. Wettergrensgata 1, Box 30053
S-400 43 Göteborg, Sweden
Tel: +46 31 89 34 00

DENMARK

**Yamaha Music Europe GmbH, Tyskland - filial
Denmark**
Generatorvej 6A, DK-2730 Herlev, Denmark
Tel: 44 92 49 00

FINLAND

F-Musiikki Oy
Kluuvikatu 6, P.O. Box 260,
SF-00101 Helsinki, Finland
Tel: 09 618511

NORWAY

**Yamaha Music Europe GmbH Germany -
Norwegian Branch**
Grini Næringspark 1, N-1361 Østerås, Norway
Tel: 67 16 78 00

ICELAND

Skifan HF
Skeifan 17 P.O. Box 8120, IS-128 Reykjavik,
Iceland
Tel: 525 5000

RUSSIA

Yamaha Music (Russia) LLC.
Room 37, bld. 7, Kievskaya street, Moscow,
121059, Russia
Tel: 495 626 5005

OTHER EUROPEAN COUNTRIES

Yamaha Music Europe GmbH
Siemensstraße 22-34, 25462 Rellingen, Germany
Tel: +49-4101-3030

AFRICA

SOUTH AFRICA

Global Music Instruments
Unit 4, 130 Boeing Road East Bedfordview 2008
Postnet Suite 130, Private Bag X10020 Edenvale
1610, South Africa
Tel: 27-11-454-1131

OTHER AFRICAN COUNTRIES

Yamaha Music Gulf FZE
LOB 16-513, P.O.Box 17328, Jebel Ali,
Dubai, United Arab Emirates
Tel: +971-4-881-5868

MIDDLE EAST

TURKEY/CYPRUS

Yamaha Music Europe GmbH
Merkezi Almanyay Türkiye Istanbul Şubesi
Maslak Meydan Sokak No:5 Spring Giz Plaza
Bağimsiz Böl. No:3, 34398 Şişli, Istanbul
Tel: +90-212-999-8010

OTHER COUNTRIES

Yamaha Music Gulf FZE
LOB 16-513, P.O.Box 17328, Jebel Ali,
Dubai, United Arab Emirates
Tel: +971-4-881-5868

ASIA

THE PEOPLE'S REPUBLIC OF CHINA

Yamaha Music & Electronics (China) Co.,Ltd.
2F, Yunhedasha, 1818 Xinzha-lu, Jingan-qu,
Shanghai, China
Tel: 021-6247-2211

HONG KONG

Tom Lee Music Co., Ltd.
11/F., Silvercord Tower 1, 30 Canton Road,
Tsimshatsui, Kowloon, Hong Kong
Tel: 2737-7688

INDIA

Yamaha Music India Pvt. Ltd.
Spazedge building, Ground Floor, Tower A, Sector
47, Gurgaon- Sohna Road, Gurgaon, Haryana, India
Tel: 0124-485-3300

INDONESIA

PT. Yamaha Musik Indonesia (Distributor)
Yamaha Music Center Bldg. Jalan Jend. Gatot
Subroto Kav. 4, Jakarta 12930, Indonesia
Tel: 021-520-2577

KOREA

Yamaha Music Korea Ltd.
8F, 9F, Dongsung Bldg. 158-9 Samsung-Dong,
Kangnam-Gu, Seoul, Korea
Tel: 02-3467-3300

MALAYSIA

Yamaha Music (Malaysia) Sdn., Bhd.
No.8, Jalan Perbandaran, Kelana Jaya, 47301
Petaling Jaya, Selangor, Malaysia
Tel: 03-78030900

PHILIPPINES

Yupango Music Corporation
339 Gil J. Puyat Avenue, P.O. Box 885 MCPO,
Makati, Metro Manila, Philippines
Tel: 819-7551

SINGAPORE

Yamaha Music (Asia) Private Limited
Block 202 Hougang Street 21, #02-00,
Singapore 530202, Singapore
Tel: 65-6747-4374

TAIWAN

Yamaha Music & Electronics Taiwan Co.,Ltd.
3F, No.6, Section 2 Nan-Jing East Road, Taipei,
Taiwan R.O.C.
Tel: 02-2511-8688

THAILAND

Siam Music Yamaha Co., Ltd.
3, 4, 15 and 16th floor, Siam Motors Building,
891/1 Rama 1 Road, Wangmai,
Pathumwan, Bangkok 10330, Thailand
Tel: 02-215-2622

VIETNAM

Yamaha Music Vietnam Company Limited
15th Floor, Nam A Bank Tower, 201-203 Cach
Mang Thang Tam St., Ward 4, Dist.3,
Ho Chi Minh City, Vietnam
Tel: +84-8-3818-1122

OTHER ASIAN COUNTRIES

**Yamaha Corporation
Market Development Section**
Nakazawa-cho 10-1, Naka-ku, Hamamatsu,
Japan 430-8650
Tel: +81-53-460-2312

OCEANIA

AUSTRALIA

Yamaha Music Australia Pty. Ltd.
Level 1, 99 Queensbridge Street, Southbank,
Victoria 3006, Australia
Tel: 3-9693-5111

NEW ZEALAND

Music Works LTD
P.O.BOX 6246 Wellesley, Auckland 4680,
New Zealand
Tel: 9-634-0099

COUNTRIES AND TRUST TERRITORIES IN PACIFIC OCEAN

**Yamaha Corporation
Market Development Section**
Nakazawa-cho 10-1, Naka-ku, Hamamatsu,
Japan 430-8650
Tel: +81-53-460-2312



ZH76640

Yamaha Global Site
<http://www.yamaha.com/>
Yamaha Downloads
<http://download.yamaha.com/>

C.S.G., DMI Development Division
© 2013 Yamaha Corporation
312MWAP*.*-01B0
Printed in Vietnam

ZH76640