



AV Receiver

HTR-3072

Owner's Manual

-
- **This unit is a product for enjoying video and music at home.**
 - **This manual explains preparations and operations for everyday users of the unit.**
 - **Read the supplied booklet "Quick Start Guide" before using the unit.**

CONTENTS

BEFORE USING THE UNIT 6

How to use this manual.....	6
How to use this manual.....	6
Checking the accessories.....	6
Checking the accessories.....	6
Using the remote control.....	6
Insert the batteries in the remote control.....	6
Operating range of the remote control.....	6

FEATURES 7

What you can do with the unit.....	7
Part names and functions.....	9
Part names and functions of the front panel.....	9
Part names and functions of the front display.....	10
Part names and functions of the rear panel.....	11
Part names and functions of the remote control.....	12

PREPARATIONS 13

1 Connecting speakers.....	13
Names and functions of speakers.....	13
Speaker systems and speakers to be connected.....	14
Speaker requirements.....	14
Setting the speaker impedance.....	15
Cable requirements.....	15
How to connect speakers.....	15
How to place speakers (speaker systems).....	17
Connecting front speakers that support bi-amp connections.....	20
2 Connecting a TV.....	21
HDMI connection with a TV.....	21
VIDEO (composite video) connection with a TV.....	21

3 Connecting playback devices.....	22
HDMI connection with a video device such as a BD/DVD player.....	22
Connection other than HDMI with a playback device.....	22
Connecting to the jack on the front panel.....	23
4 Connecting the FM/AM antennas.....	24
Connecting the FM/AM antennas.....	24
5 Plugging in the power cable.....	24
Plugging in the power cable.....	24
6 Selecting the on-screen menu language.....	25
Selecting the on-screen menu language.....	25
7 Configuring the necessary speaker settings.....	26
Assigning speaker configuration.....	26
Optimizing the speaker settings automatically (YPAO).....	27
Error messages from YPAO.....	29
Warning messages from YPAO.....	30

ENJOYING SOUND 31

Enjoying sound field effects.....	31
Select your favorite sound mode.....	31
Enjoying sound field effects (CINEMA DSP).....	31
Enjoying sound field effects optimized for the type of content.....	31
Enjoying sound field effects without surround speakers (Virtual CINEMA DSP).....	32
Enjoying surround sound with 5 speakers placed in front (Virtual CINEMA FRONT).....	32
Enjoying surround sound with headphones (SILENT CINEMA).....	32
Enjoying unprocessed playback.....	33
Enjoying original sound (straight decode).....	33
Enjoying multichannel playback without sound field effects (surround decoder).....	33
Enjoying pure high fidelity sound (direct playback).....	34
Enjoying enhanced bass sound.....	34
Enhancing the bass (Extra Bass).....	34
Enjoying enhanced compressed music.....	35
Playing back digitally compressed formats with enriched sound (Compressed Music Enhancer).....	35

PLAYBACK 36

Basic playback procedure.....	36
Basic procedure for playing back video and music.....	36
Switching information on the front display.....	37
Item names and functions of the playback screen.....	38
Item names and functions of the browse screen.....	39
Listening to FM/AM radio.....	40
Setting the frequency steps.....	40
Selecting a frequency for reception.....	41
Selecting a preset station.....	42
Registering radio stations automatically (Auto Preset).....	42
Registering a radio station manually.....	43
Clearing preset stations.....	44
Displaying the Radio Data System information.....	44
Receiving traffic information automatically.....	45
Playing back music stored on a Bluetooth® device.....	46
Connecting a Bluetooth® device (pairing).....	46
Playback of Bluetooth® device contents.....	47
Enjoying audio using Bluetooth® speakers/headphones.....	48
Playing back music stored on a USB storage device.....	49
Playback of USB storage device contents.....	49
Useful playback functions.....	50
SCENE function.....	50

Configuring playback settings for different playback sources (Option menu)..... 52

Basic operation of the Option menu.....	52
Option menu items.....	53
Switching the input source.....	53
Adjusting the tone of the audio output.....	53
Configuring DSP/Surround.....	54
Correcting volume differences during playback.....	56
Enabling Lipsync adjustment.....	57
Checking information about the video/audio signals.....	57
Combining audio of another input source with video of the current input source.....	57
Selecting a video source to be output with the selected audio source.....	59
Switching between stereo and monaural for FM radio reception.....	59
Setting presets for radio stations.....	59
Receiving traffic information automatically.....	60
Configuring the repeat setting.....	61
Performing pairing with a Bluetooth® device.....	62
Connecting a previously-connected Bluetooth® device.....	62
Disconnecting the connection with a Bluetooth® device.....	63
Enabling automatic switching of the input source when Bluetooth® connects.....	63

CONFIGURATIONS 64

Configuring various functions (Setup menu)..... 64

Basic operation of the Setup menu.....	64
Setup menu items.....	65

Configuring the speaker settings.....	67
Setting your speaker system.....	67
Setting the use of a subwoofer.....	67
Setting the size of the front speakers.....	67
Setting the use of a center speaker and its size.....	68
Setting the use of surround speakers and their size.....	68
Setting the crossover frequency of the low-frequency components.....	69
Setting the phase of the subwoofer.....	69
Setting the use of Extra Bass.....	69
Setting the use of Virtual CINEMA FRONT.....	70
Setting the distance between each speaker and the listening position.....	70
Adjusting the volume of each speaker.....	70
Setting the equalizer.....	71
Outputting test tones.....	71
Configuring the HDMI settings.....	72
Setting the use of HDMI Control.....	72
Setting the output of HDMI audio from the TV speaker.....	72
Setting the use of HDMI Standby Through.....	72
Setting the use of 4K upscaling of the HDMI video signal.....	72
Setting the version of HDCP used on the HDMI input jacks.....	73
Setting the audio jack used for TV audio input.....	73
Linking the standby modes of the unit and the TV.....	73
Setting the use of ARC.....	73
Setting the use of SCENE link playback.....	74
Configuring the sound settings.....	75
Setting the broadening effect of the front sound field.....	75
Adjusting the broadening effect of the center sound field.....	75
Adjusting the difference in level between the front and surround sound fields.....	75
Adjusting the center localization (broadening effect) of the front sound field.....	75
Setting the use of Monaural Mix.....	76
Setting the adjustment method of the Lipsync function.....	76
Adjusting the delay of the Lipsync function.....	76
Adjusting the volume of dialogue sound.....	76
Setting the scale of the volume display.....	77
Setting the dynamic range adjustment method.....	77
Setting the limit value of the volume.....	77
Setting the initial volume for when the unit is turned on.....	77

Configuring the power supply settings.....	78
Setting the amount of time for the auto-standby function.....	78
Setting the use of the eco mode.....	78
Configuring the function settings.....	79
Automatically changing the input source names displayed on the front display.....	79
Manually changing the input source names displayed on the front display.....	79
Setting input sources to be skipped when operating the INPUT key.....	80
Adjusting the brightness of the front display.....	80
Preventing accidental changes to the settings.....	80
Setting the unit's functions for the RED/GREEN/YELLOW/BLUE keys of the remote control.....	81
Configuring the Bluetooth® settings.....	82
Setting the use of Bluetooth®.....	82
Terminating the connection between a Bluetooth® device and the unit.....	82
Setting the use of the Bluetooth® Standby function.....	82
Setting the use of audio transmission to a Bluetooth® device.....	83
Connecting the unit to a Bluetooth® device that receives transmitted audio.....	83
Configuring the language settings.....	84
Setting the on-screen menu language.....	84
Configuring the advanced settings (ADVANCED SETUP menu).....	85
Basic operation of the ADVANCED SETUP menu.....	85
ADVANCED SETUP menu items.....	85
Changing the speaker impedance setting (SP IMP.).....	85
Selecting the remote control ID (REMOTE ID).....	86
Changing the FM/AM tuning frequency setting (TU).....	86
Switching the video signal type (TV FORMAT).....	87
Selecting the HDMI 4K signal format (4K MODE).....	87
Restoring the default settings (INIT).....	88
Updating the firmware (UPDATE).....	88
Checking the firmware version (VERSION).....	88

TROUBLESHOOTING 89

When any problem appears..... 89

If trouble occurs, first check the following:.....	89
Power, system, or remote control trouble.....	89
Audio trouble.....	91
Video trouble.....	94
FM/AM radio trouble.....	95
USB trouble.....	95
Bluetooth® trouble.....	96

Error indications on the front display..... 97

Error indications on the front display.....	97
---	----

APPENDIX 98

Input/output jacks and cables..... 98

Video/audio jacks.....	98
Video jacks.....	98
Audio jacks.....	98

Glossary..... 99

Glossary of audio information.....	99
Glossary of HDMI and video information.....	100
Glossary of Yamaha technologies.....	100

Supported devices and file formats..... 101

Supported Bluetooth® devices.....	101
Supported USB devices.....	101
Supported file formats.....	101

Video signal flow..... 101

Video signal flow.....	101
------------------------	-----

Additional information on HDMI..... 102

HDMI Control and synchronized operations.....	102
Audio Return Channel (ARC).....	103
HDMI signal compatibility.....	104

Trademarks..... 105

Trademarks.....	105
-----------------	-----

Specifications..... 106

Specifications.....	106
---------------------	-----

Default settings..... 110

Default settings of the Option menu.....	110
Default settings of the Setup menu.....	110
Default settings of the ADVANCED SETUP menu.....	111

BEFORE USING THE UNIT

How to use this manual

How to use this manual

When reading this manual, mind the following items.

- Some features are not available in certain regions.
- Due to product improvements, specifications and appearance are subject to change without notice.
- This manual mainly explains operations using the menu displayed on the TV screen. Operations with the TV screen menu are only available when your TV is connected to the unit via HDMI.
- This manual explains operations using the supplied remote control.



Warning:

Indicates precautions for the possibility of death or serious injury.



Caution:

Indicates precautions for the possibility of minor or moderate injury.

Notice:

Indicates precautions for use to avoid the possibility of malfunction/damage to the unit.

Note:

Indicates instructions and supplementary explanations for optimum use.

Checking the accessories

Checking the accessories

Check that the following accessories are supplied with the product.

AM antenna



FM antenna

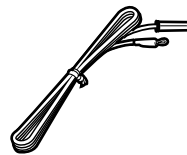
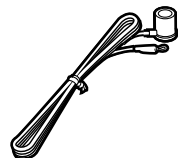

YPAO microphone

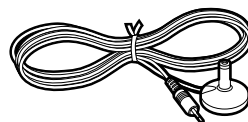

* One of the above is supplied depending on the region of purchase.

Remote control

Batteries (AAA, R03, UM-4) (x2)

Quick Start Guide

Note

Access the Yamaha Downloads site to download the latest Owner's Manual and Quick Start Guide.
<http://download.yamaha.com/>

Using the remote control

Insert the batteries in the remote control

Insert the batteries the right way round.

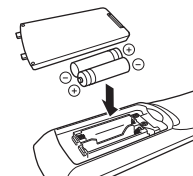

Operating range of the remote control

Point the remote control at the remote control sensor on the unit and remain within the operating range shown in the following figure.

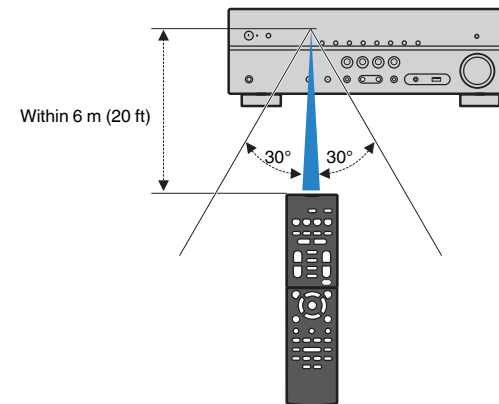

FEATURES

What you can do with the unit

Supporting 2- to 5.1-channel speaker system

According to the number of speakers that you are using, you can enjoy your favorite acoustic spaces in various styles.

- “Using 5.1-channel system” (p.17)
- “Using 3.1-channel system” (p.18)
- “Using Virtual CINEMA FRONT” (p.19)

Automatically optimizing the speaker settings (YPAO)

YPAO function detects speaker connections, measures the distances from them to your listening position by using YPAO microphone measurement, and then automatically optimizes the speaker settings, such as volume balance and acoustic parameters, to suit your room (YPAO: Yamaha Parametric room Acoustic Optimizer).

- “Optimizing the speaker settings automatically (YPAO)” (p.27)

Enjoying sound field effects with much presence

The unit is equipped with a variety of sound programs and surround decoders that allow you to enjoy playback sources with your favorite sound mode (such as sound field effect or stereo playback).

- “Enjoying sound field effects (CINEMA DSP)” (p.31)
- “Enjoying sound field effects optimized for the type of content” (p.31)
- “Enjoying sound field effects without surround speakers (Virtual CINEMA DSP)” (p.32)
- “Enjoying surround sound with headphones (SILENT CINEMA)” (p.32)
- “Enjoying original sound (straight decode)” (p.33)
- “Enjoying multichannel playback without sound field effects (surround decoder)” (p.33)
- “Enjoying pure high fidelity sound (direct playback)” (p.34)
- “Enhancing the bass (Extra Bass)” (p.34)
- “Playing back digitally compressed formats with enriched sound (Compressed Music Enhancer)” (p.35)

Playing back content of various devices

A number of HDMI jacks and various input/output jacks on the unit allow you to connect video devices (such as BD/DVD players), audio devices (such as CD players), Bluetooth devices (such as smartphones), game consoles, USB storage devices, and other devices. You can play back content of them.

- “Selecting a frequency for reception” (p.41)
- “Playback of Bluetooth® device contents” (p.47)
- “Playback of USB storage device contents” (p.49)

Useful functions

The unit is equipped with the various useful functions. The SCENE function allows you to select the input source and settings registered to the corresponding scene, such as sound program and Compressed Music Enhancer on/off, with just one touch. When the unit is connected to an HDMI Control-compatible TV with an HDMI cable, you can control the unit (such as power and volume) with TV remote control operations.

- “Selecting the input source and favorite settings with one touch (SCENE)” (p.50)
- “HDMI Control and synchronized operations” (p.102)
- “Audio Return Channel (ARC)” (p.103)

Useful applications

Application: “AV SETUP GUIDE”



AV SETUP GUIDE is an application that assists you with cable connections between AV Receiver and playback devices as well as AV Receiver setup. This app guides you through the various settings such as speaker connections, TV and playback device connections and selecting the speaker system.

For details, search for “AV SETUP GUIDE” on the App Store or Google Play.

Part names and functions

Part names and functions of the front panel

The part names and functions of the front panel are as follows.

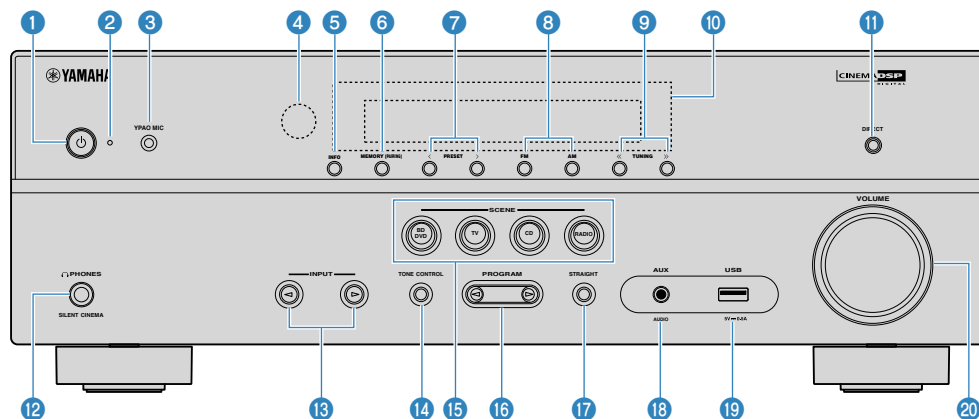

1 **⏻ (power) key**

Turns on/off (standby) the unit.

2 **Standby indicator**

Lights up when the unit is in standby mode under any of the following conditions.

- HDMI Control is enabled (p.72)
- Standby Through is enabled (p.72)
- Bluetooth Standby is enabled (p.82)

3 **YPAO MIC jack**

For connecting the supplied YPAO microphone (p.27).

4 **Remote control sensor**

Receives remote control signals (p.6).

5 **INFO key**

Selects the information displayed on the front display (p.37).

6 **MEMORY (PAIRING) key**

Registers FM/AM radio stations as preset stations (p.42).

Starts pairing with a Bluetooth device by holding down for a few seconds (p.46).

7 **PRESET keys**

Select a preset FM/AM radio station (p.42).

8 **FM and AM keys**

Switch between FM and AM (p.41).

9 **TUNING keys**

Select the radio frequency (p.41).

10 **Front display**

Displays information (p.10).

11 **DIRECT key**

Enables/disables the direct playback mode (p.34).

12 **PHONES jack**

For connecting headphones.

13 **INPUT keys**

Select an input source.

14 **TONE CONTROL key**

Adjusts the level of high-frequency range (Treble) and low-frequency range (Bass) individually (p.53).

15 **SCENE keys**

Switch with one touch between multiple settings set using the SCENE function. Also, turns on the unit when it is in standby mode (p.50).

16 **PROGRAM keys**

Select a sound program or a surround decoder (p.31).

17 **STRAIGHT key**

Enables/disables the straight decode mode (p.33).

18 **AUX jack**

For connecting devices, such as portable audio players (p.23).

19 **USB jack**

For connecting a USB storage device (p.49).

20 **VOLUME knob**

Adjusts the volume.

Part names and functions of the front display

The part names and functions of the front display are as follows.

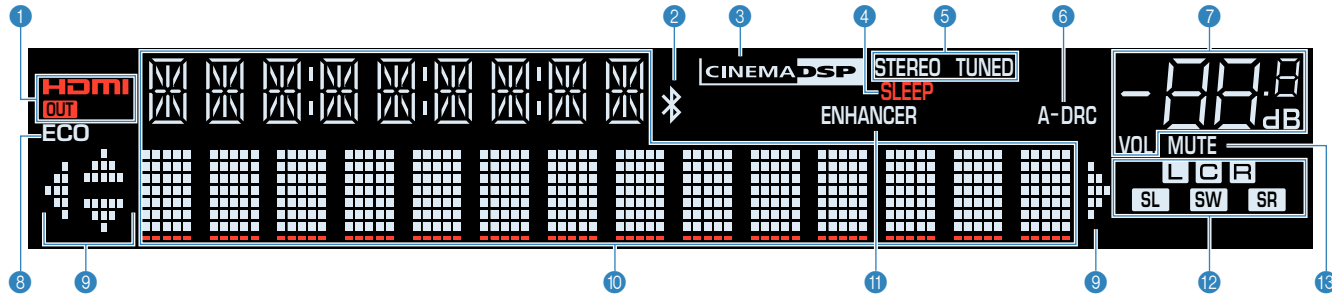

1 HDMI

Lights up when HDMI signals are being input or output.

OUT

Lights up when HDMI signals are being output.

2 Bluetooth indicator

Light up while the unit is connected to a Bluetooth device.

3 CINEMA DSP

Lights up when CINEMA DSP (p.31) is working.

4 SLEEP

Lights up when the sleep timer is on.

5 STEREO

Lights up when the unit is receiving a stereo FM radio signal.

TUNED

Lights up when the unit is receiving an FM/AM radio station signal.

6 A-DRC

Lights up when Adaptive DRC (p.56) is working.

7 Volume indicator

Indicates the current volume.

8 ECO

Lights up when the eco mode (p.78) is enabled.

9 Cursor indicators

Indicate the remote control cursor keys currently operational.

10 Information display

Displays the current status (such as input name and sound mode name). You can switch the information by pressing INFO (p.37).

11 ENHANCER

Lights up when Compressed Music Enhancer (p.35) is working.

12 Speaker indicators

Indicate speaker terminals from which signals are output.

L Front speaker (L)

R Front speaker (R)

C Center speaker

SL Surround speaker (L)

SR Surround speaker (R)

SW Subwoofer

13 MUTE

Blinks when audio is temporarily muted.

Part names and functions of the rear panel

The part names and functions of the rear panel are as follows.

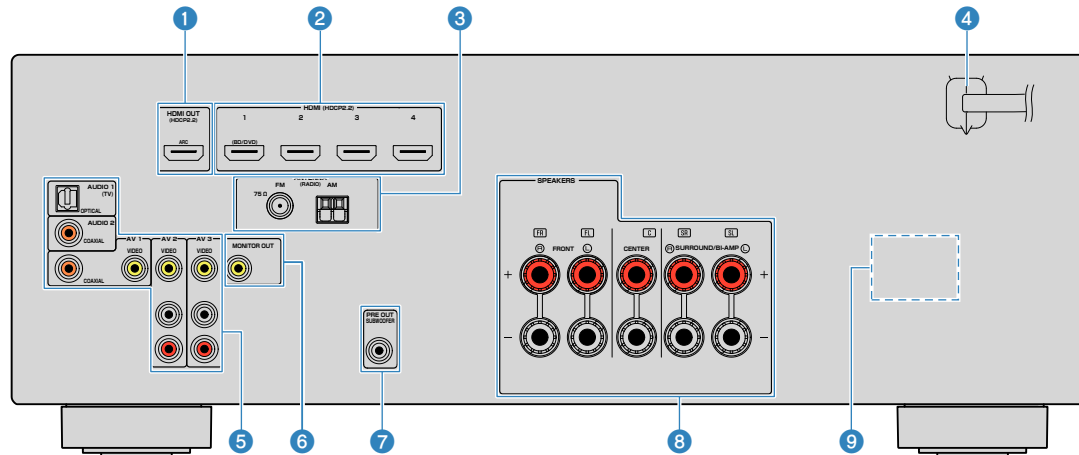

• The area around the video/audio output jacks is marked in white on the actual product to prevent improper connections.

1 HDMI OUT jack

For connecting to an HDMI-compatible TV and outputting video/audio signals (p.21). When using ARC, TV audio signal can also be input through the HDMI OUT jack.

2 HDMI 1-4 jacks

For connecting to HDMI-compatible playback devices and inputting video/audio signals (p.22).

3 ANTENNA jacks

For connecting to FM and AM antennas (p.24).

4 Power cable

For connecting to an AC wall outlet (p.24).

5 AV jacks AUDIO jacks

For connecting to video/audio playback devices and inputting video/audio signals (p.22).

6 MONITOR OUT jack

For connecting to a TV and outputting video signals (p.21).

7 SUBWOOFER PRE OUT jack

For connecting to a subwoofer (with built-in amplifier) (p.16).

8 SPEAKERS terminals

For connecting to speakers (p.13).

9 VOLTAGE SELECTOR

(Taiwan, Brazil and Central and South America models only)
Selects the switch position according to your local voltage (p.24).

Part names and functions of the remote control

The part names and functions of the supplied remote control are as follows.

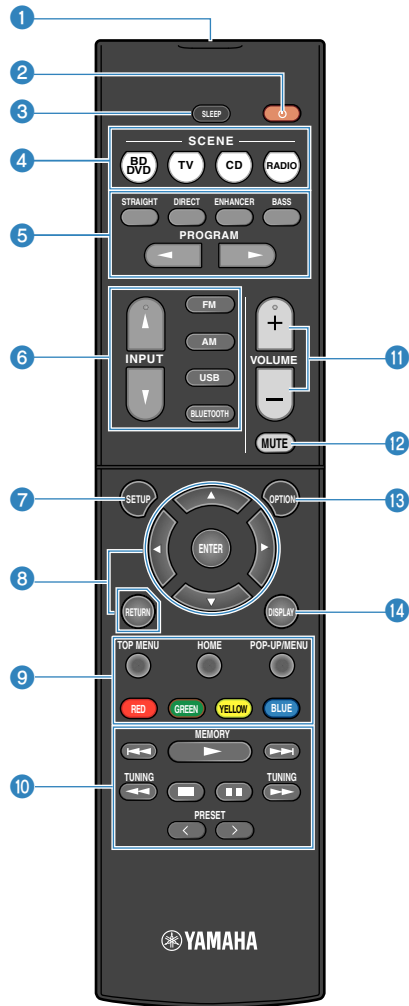

1 Remote control signal transmitter

Transmits infrared signals.

2 (receiver power) key

Turns on/off (standby) the unit.

3 SLEEP key

Pressing this key repeatedly will specify the time (120 min, 90 min, 60 min, 30 min, off), in which the unit switches to the standby mode.

4 SCENE keys

Switch with one touch between multiple settings set using the SCENE function. Also, turn on the unit when it is in standby mode (p.50).

5 Sound mode keys

Select a sound mode (p.31).

6 Input selection keys

Select an input source for playback.

7 SETUP key

Displays the setup menu (p.64).

8 Menu operation keys

Operates the menu.

8 9 10 11 12 External device operation keys

Let you perform playback operations when "USB" is selected as the input source, or control playback of the HDMI Control-compatible playback device.

Note

- The playback devices must support HDMI Control. Some HDMI Control-compatible devices cannot be used.
- You can assign the unit's functions to the RED/GREEN/YELLOW/BLUE keys (p.81).

10 Playback operation keys

Controls playback of the external device.

11 VOLUME keys

Adjust the volume.

12 MUTE key

Mutes the audio output.

13 OPTION key

Displays the option menu (p.52).

14 DISPLAY key

Turns on/off the browse screen, playback screen, etc.

PREPARATIONS

1 Connecting speakers

Names and functions of speakers

The names and functions of speakers connected to the unit are as follows.

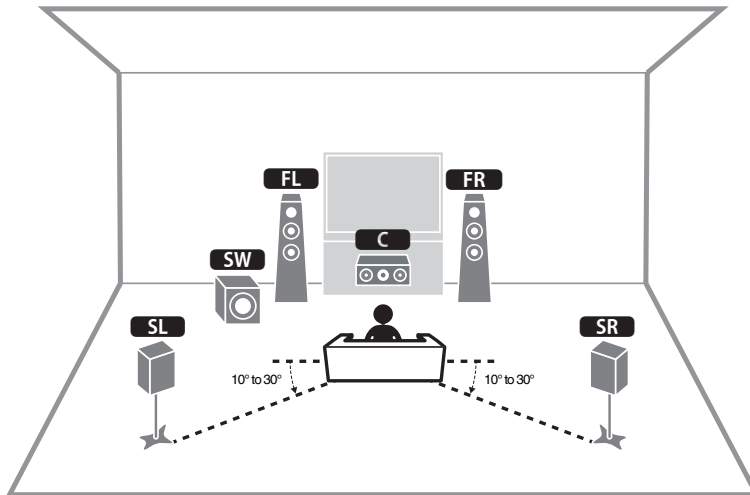

Note

Use this diagram as a reference for the ideal speaker layout for the unit. Your speaker layout does not need to match the diagram exactly, since the YPAO function can be used to automatically optimize the speaker settings (such as distances) to suit the actual speaker layout.

Speaker type	Abbr.	Function
Front (L/R)	FL / FR	Produce front channel sounds (stereo sounds).
Center	C	Produces center channel sounds (such as movie dialogue and vocals).
Surround (L/R)	SL / SR	Produce surround channel sounds.
Subwoofer	SW	Produces LFE (low-frequency effect) channel sounds and reinforces the bass parts of other channels.

Speaker systems and speakers to be connected

Select the speaker layout for the number of speakers that you are using and place the speakers and subwoofer in your room.

Speaker type	Speaker system (the number of channels)		
	5.1	3.1	2.1
Front (L/R) FL / FR	●	●	●
Center C	●	●	
Surround (L/R) SL / SR	●		
Subwoofer SW	●	●	●

Speaker requirements

Speakers and subwoofers to be connected to the unit must meet the following requirements:

- (U.S.A. and Canada models only)
Under its default settings, the unit is configured for 8-ohm speakers. When connecting 6-ohm speakers, set the unit's speaker impedance to "6 Ω MIN". For details, see the following:
 - "Setting the speaker impedance" (p.15)
- (Except for U.S.A. and Canada models)
Use speakers with an impedance of at least 6 Ω.
- Use a subwoofer with built-in amplifier.

Note

- Prepare the number of speakers according to your speaker system.
- Be sure to connect the front left and right speakers.

Setting the speaker impedance

(U.S.A. and Canada models only)

Under its default settings, the unit is configured for 8-ohm speakers. When connecting 6-ohm speakers, set the speaker impedance to "6 Ω MIN".

1 Before connecting speakers, connect the power cable to an AC wall outlet.

2 While holding down STRAIGHT on the front panel, press  (power).

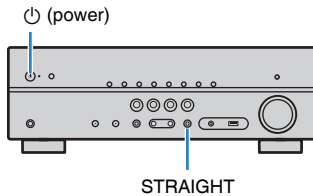

3 Check that "SP IMP." is displayed on the front display.



4 Press STRAIGHT to select "6 Ω MIN".

5 Press  (power) to set the unit to standby mode and remove the power cable from the AC wall outlet.

You are now ready to connect the speakers.

Cable requirements

Use the following types of commercially-available cables to connect speakers to the unit:

Speaker cables (the number of speakers required)



Audio pin cable (for connecting a subwoofer)



How to connect speakers

■ Connecting the speaker

Connect a speaker cable between the negative (-) terminal of the unit and the negative (-) terminal of the speaker, and between the positive (+) terminal of the unit and the positive (+) unit of the speaker.

Notice

When connecting the speaker cables, take notice of the following:

- Prepare speaker cables in a place away from the unit, to avoid accidentally dropping wire strands into the unit's interior which could result in a short circuit or malfunction of the unit.
- Improper connecting of the speaker cables may cause a short circuit and also damage the unit or the speakers.

– Twist the bare wires of the speaker cables firmly together.

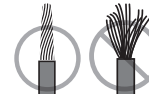

– Do not let the bare wires of the speaker cable touch one another.

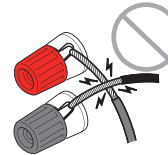

– Do not let the bare wires of the speaker cable come into contact with the unit's metal parts (rear panel and screws).

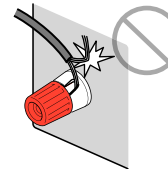

Note

- Remove the unit's power cable from an AC wall outlet before connecting the speakers.
- Be sure to connect the front left and right speakers.
- (U.S.A. and Canada models only)
Under its default settings, the unit is configured for 8-ohm speakers. When connecting 6-ohm speakers, set the unit's speaker impedance to "6 Ω MIN". For details, see the following:
 - "Setting the speaker impedance" (p.15)

- 1 Remove approximately 10 mm (3/8") of insulation from the ends of the speaker cable, and twist the bare wires of the cable firmly together.**
- 2 Loosen the speaker terminal.**
- 3 Insert the bare wires of the cable into the gap on the side (upper right or bottom left) of the terminal.**
- 4 Tighten the terminal.**

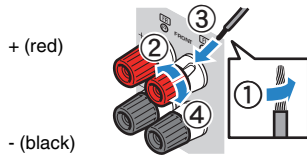

This completes the connection.

Note

- If "Check SP Wires" appears on the front display when the unit is turned on, turn off the unit, and then confirm that the speaker cables are not short circuited.
- (U.S.A., Canada, China, Taiwan, Brazil and Central and South America models only)
When using a banana plug, tighten the speaker terminal and insert a banana plug into the end of the terminal.

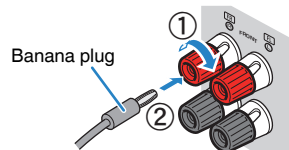

Connecting the subwoofer

Use an audio pin cable to connect the subwoofer.

Note

Unplug the power cables of the unit and subwoofer from the AC wall outlets before connecting the subwoofer.

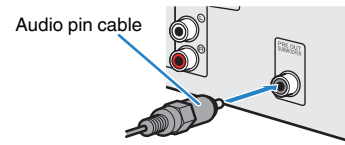

How to place speakers (speaker systems)

Using 5.1-channel system

This is a basic speaker layout recommended for enjoying surround sound.

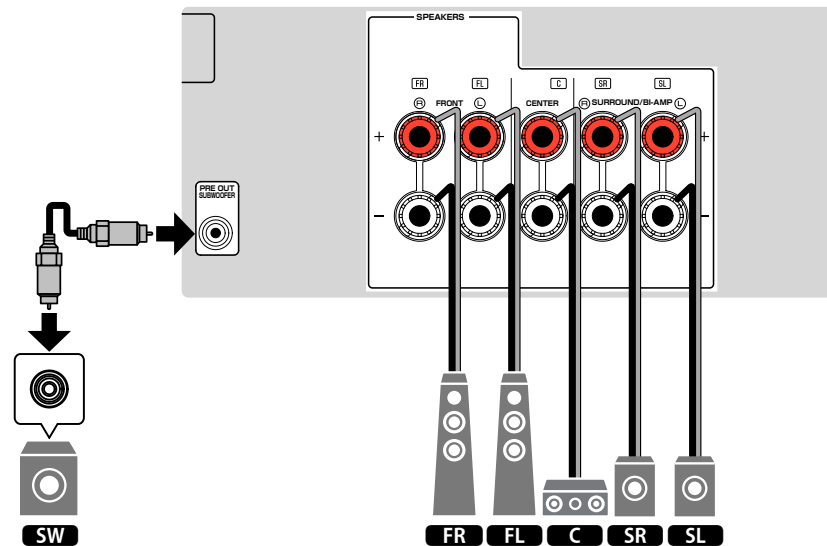
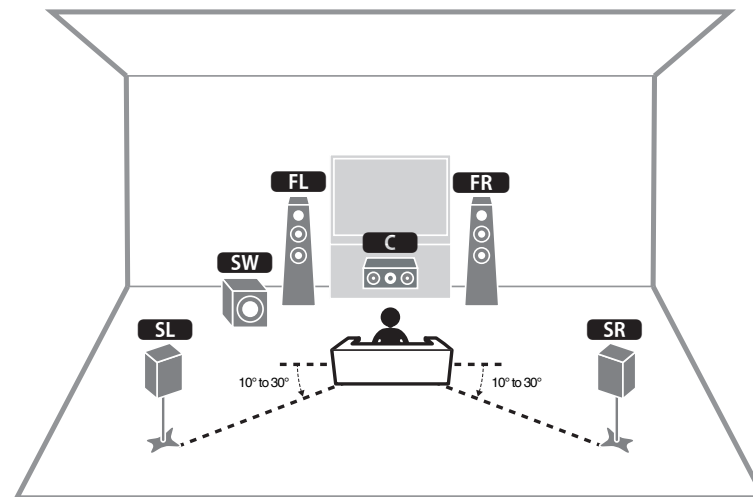

Using 3.1-channel system

This is a speaker layout recommended for enjoying stereo sound with a center speaker. Center channel sound such as movie dialogue and vocals can be clearly obtained.

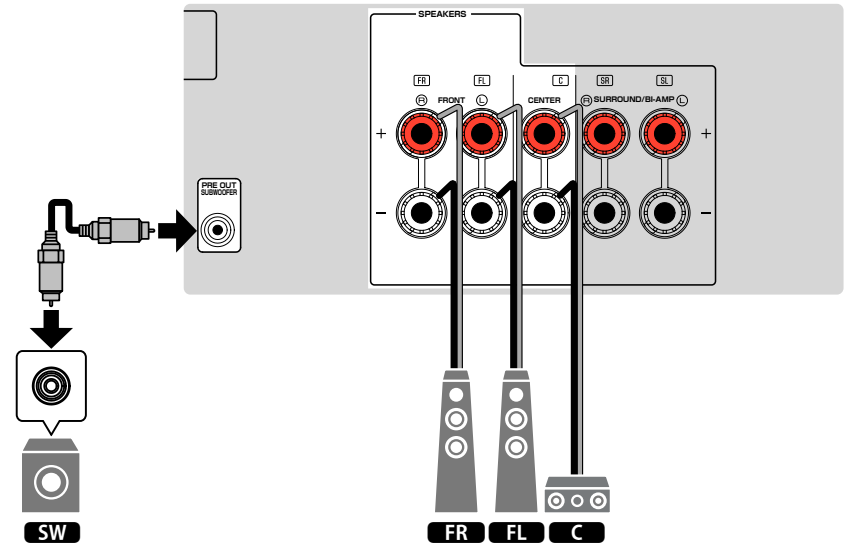
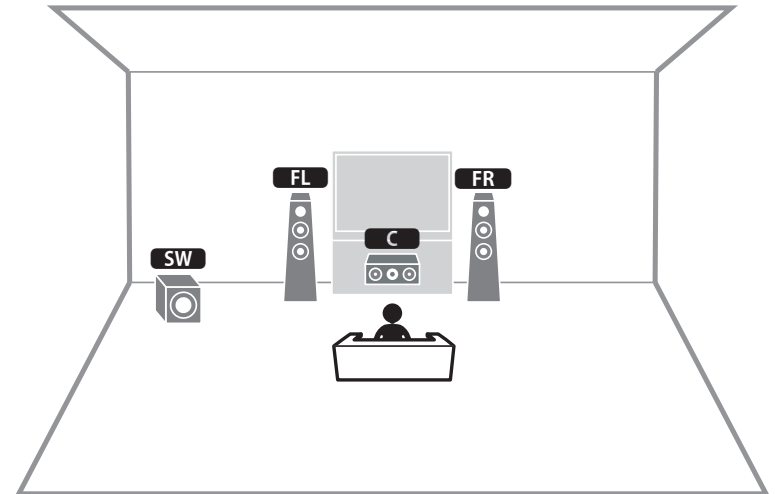

Using Virtual CINEMA FRONT

This speaker layout is recommended if you cannot place speakers in the back of the room.

Note

To use Virtual CINEMA FRONT, the speaker configuration settings must be changed. For details, see the following:

- “Assigning speaker configuration” (p.26)
- “Setting the use of Virtual CINEMA FRONT” (p.70)

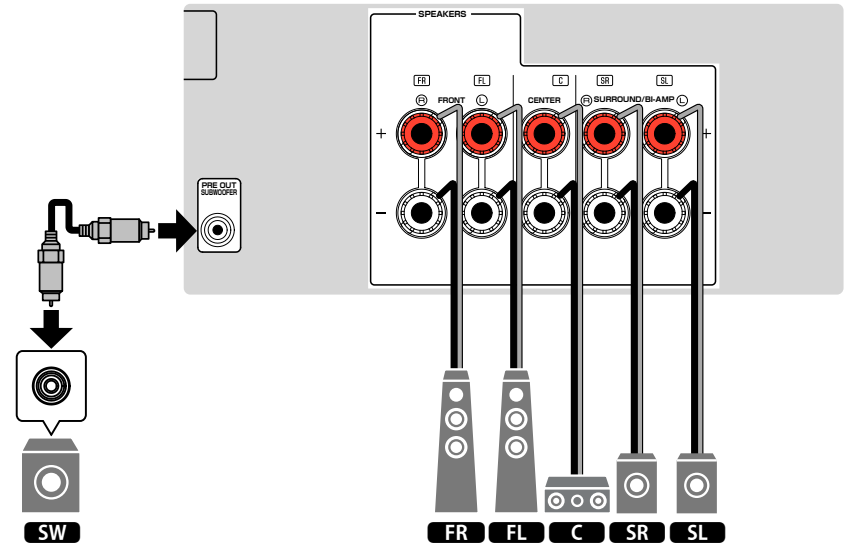
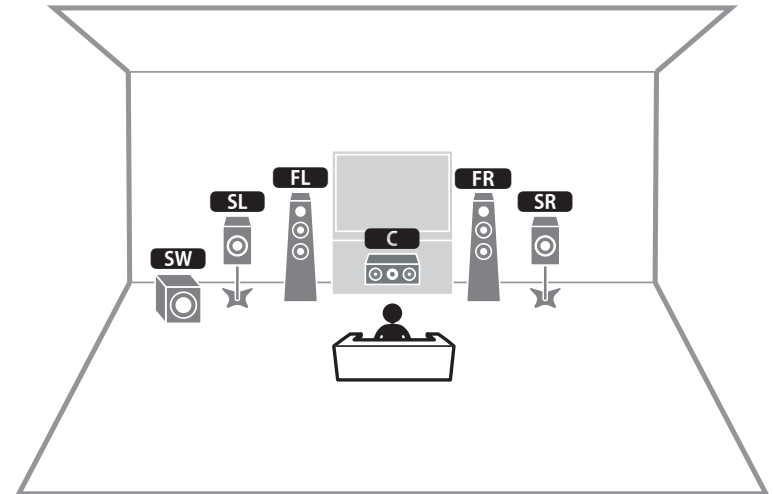

Connecting front speakers that support bi-amp connections

You can connect the front speakers that support bi-amp connections.

To enable the bi-amp function, configure the necessary speaker settings. For details, see the following:

- “Assigning speaker configuration” (p.26)
- “Setting your speaker system” (p.67)

Notice

- Before making bi-amp connections, remove any brackets or cables that connect a woofer with a tweeter. Refer to the instruction manual of the speakers for details. If you are not making bi-amp connections, make sure that the brackets or cables are connected before connecting the speaker cables.

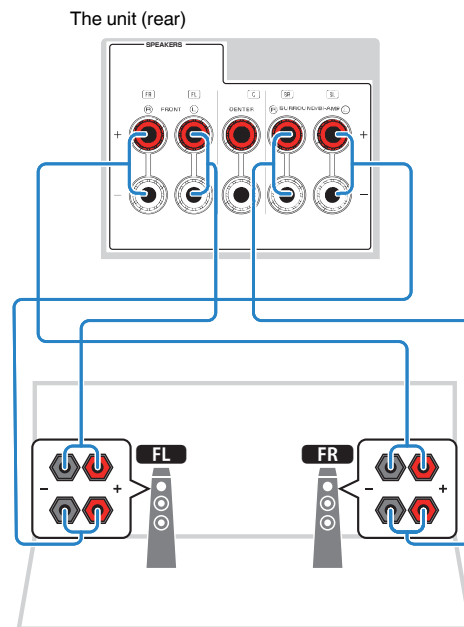

Note

- The following speakers cannot be connected simultaneously.
 - Surround speakers
 - Bi-amp speakers
- The FRONT terminals and SURROUND/BI-AMP terminals output the same signals.

2 Connecting a TV

HDMI connection with a TV

Connect a TV to the unit with an HDMI cable. If you connect a TV that supports ARC to the unit, you can output video/audio to the TV or input TV audio to the unit.

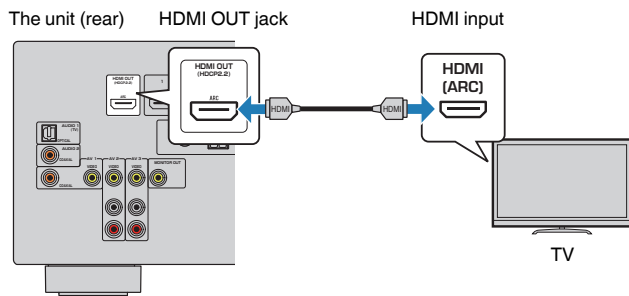

About Audio Return Channel (ARC)

- ARC allows audio signals to travel both ways with a single HDMI cable. To use ARC, connect to the TV using an HDMI cable that supports ARC.

Note

- If you connect a TV that supports HDMI Control to the unit with an HDMI cable, you can control the unit's power and volume with the TV's remote control.
- To use HDMI Control and ARC, you need to configure the HDMI settings on the unit. For details on the settings, see the following:
 - "HDMI Control and synchronized operations" (p.102)
 - "Audio Return Channel (ARC)" (p.103)
- If your TV does not support Audio Return Channel (ARC), a digital optical cable connection between the TV and the unit is needed.

VIDEO (composite video) connection with a TV

Connect a TV to the unit with a video pin cable and a digital optical cable.

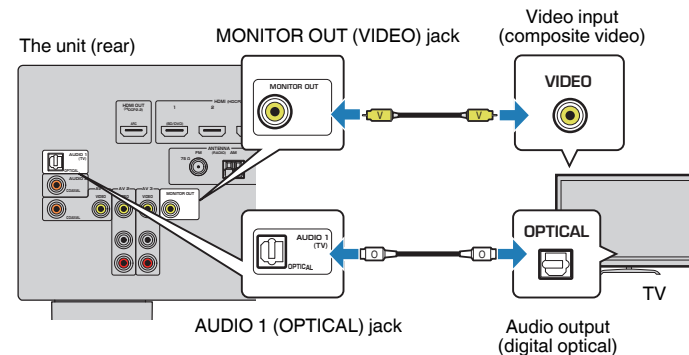

Note

- If you connect your TV to the unit with a cable other than HDMI, video input to the unit via HDMI cannot be output to the TV. For details, see the following:
 - "Video signal flow" (p.101)
- Operations with TV screen are available only when your TV is connected to the unit via HDMI.
- A digital optical cable connection allows audio from the TV to be played back on the unit. A digital optical cable connection is not needed in the following case:
 - If you will receive TV broadcasts only from the set-top box

3 Connecting playback devices

HDMI connection with a video device such as a BD/DVD player

Connect a video device to the unit with an HDMI cable.

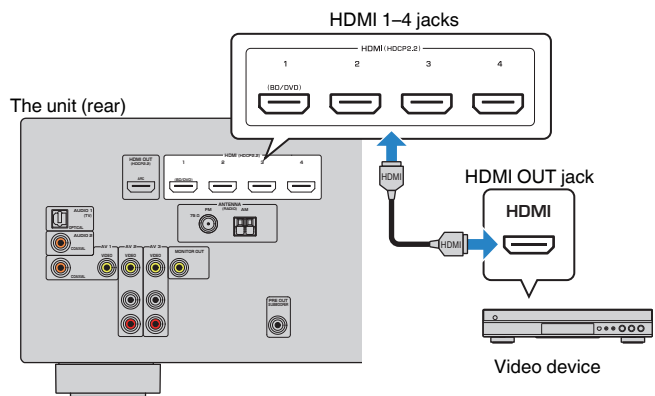

Note

To watch video input to the HDMI 1-4 jacks, you need to connect your TV to the HDMI OUT jack of the unit. For details, see the following:

- "HDMI connection with a TV" (p.21)

Connection other than HDMI with a playback device

VIDEO (composite video) connection with a video device

Connect a video device to the unit with a video pin cable and an audio cable (digital coaxial or stereo pin cable). Choose a set of input jacks (on the unit) depending on the audio output jacks available on your video device.

Output jacks on video device		Input jacks on the unit
Video	Audio	
Composite video	Digital coaxial	AV 1 (VIDEO + COAXIAL)
	Analog stereo	AV 2-3 (VIDEO + AUDIO)
	Digital optical	You need to change the combination of video/audio input jacks (p.57).

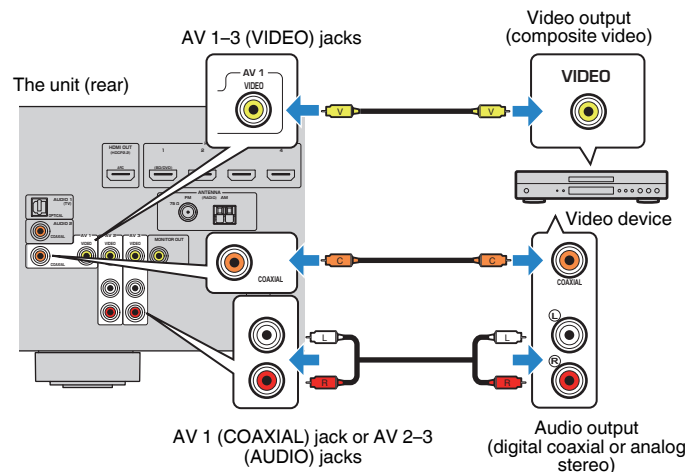

Note

- To watch videos input to the AV 1-3 (VIDEO) jacks, you need to connect your TV to the MONITOR OUT (VIDEO) jack of the unit. For details, see the following:
 - "VIDEO (composite video) connection with a TV" (p.21)
- If the combination of video/audio input jacks available on the unit does not match your video device, change its combination according to the output jacks of your device. For details, see the following:
 - "Combining audio of another input source with video of the current input source" (p.57)

AUDIO connection with an audio device such as a CD player

Connect audio devices such as CD players and MD players to the unit. Depending on the audio output jacks available on your audio device, choose one of the following connections.

Note

To use a turntable, a commercially-available phono equalizer amplifier is required. Connect the output of the phono equalizer amplifier to the unit.

Audio output jacks on audio device	Audio input jacks on the unit
Digital optical	AUDIO 1 (OPTICAL)
Digital coaxial	AUDIO 2 (COAXIAL) AV 1 (COAXIAL)
Analog stereo	AV 2-3 (AUDIO)

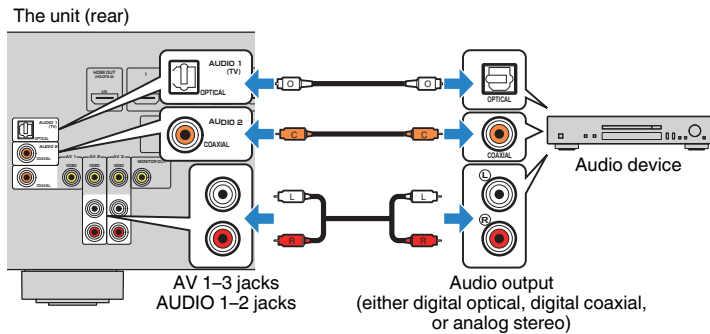

Note

“AUDIO1” is set as TV audio input at the factory. If you have connected any external device to the AUDIO 1 jacks, use “TV Audio Input” in the “Setup” menu to change the TV audio input assignment. To use the SCENE function, you also need to change the input assignment for SCENE (TV). For details, see the following:

- “Setting the audio jack used for TV audio input” (p.73)
- “Registering a scene” (p.51)

Connecting to the jack on the front panel

Use the AUX jack on the front panel to temporarily connect devices such as portable audio players to the unit.



Caution

- Before making a connection, stop playback on the device and turn down the volume on the unit. The volume may be unexpectedly loud, and this could result in damage to hearing.

Note

You need to prepare the audio cable that matches the output jacks on your device.

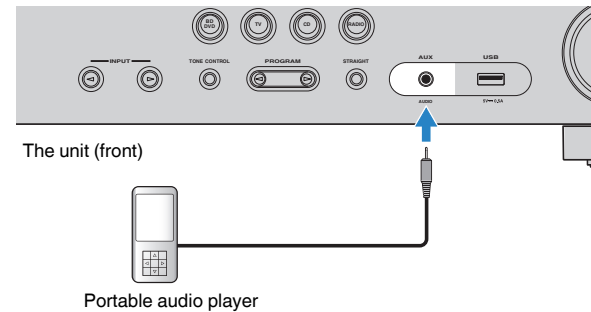

If you select “AUX” as the input source by pressing INPUT, the audio played back on the device will be output from the unit.

4 Connecting the FM/AM antennas

Connecting the FM/AM antennas

Connect the supplied FM/AM antennas to the unit.

Fix the end of the FM antenna to a wall, and place the AM antenna on a flat surface.

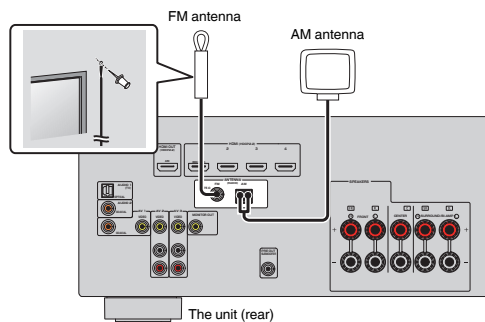

Assembling and connecting the AM antenna

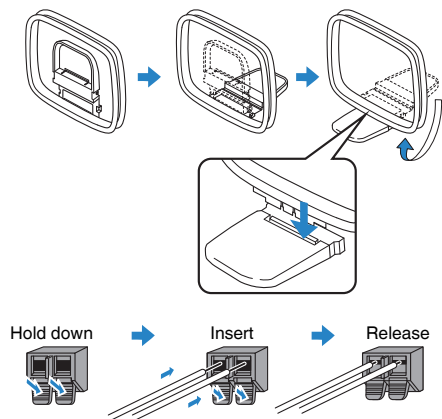

Note

- Unwind only the length of cable needed from the AM antenna unit.
- The wires of the AM antenna have no polarity.

5 Plugging in the power cable

Plugging in the power cable



Warning

(Taiwan, Brazil and Central and South America models only)

Make sure you set VOLTAGE SELECTOR of the unit BEFORE plugging the power cable into an AC wall outlet. Improper setting of VOLTAGE SELECTOR may cause damage to the unit and create a potential fire hazard.

Before plugging in the power cable

Set the switch position of VOLTAGE SELECTOR according to your local voltage. Voltages are AC 110–120/220–240 V, 50/60 Hz.

The unit (rear)

VOLTAGE SELECTOR

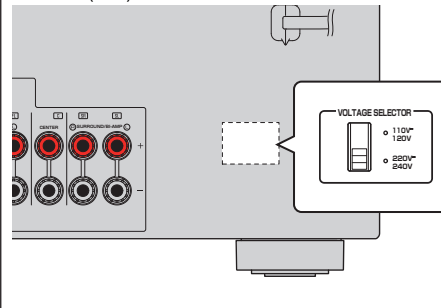

After all the connections are complete, plug in the power cable.

The unit (rear)

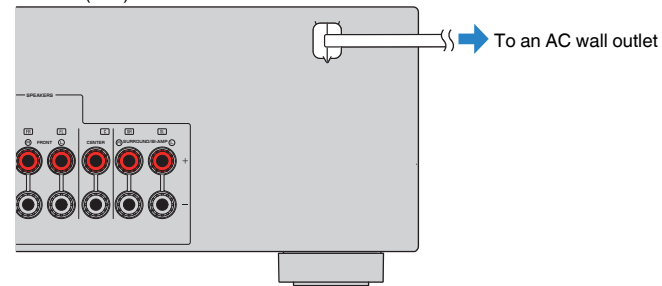

6 Selecting the on-screen menu language

Selecting the on-screen menu language

Select the desired on-screen menu language.

- 1 Press **⏻** (receiver power) to turn on the unit.
- 2 Turn on the TV and switch the TV input to display video from the unit (HDMI OUT jack).
- 3 Press **SETUP**.
- 4 Use the cursor keys to select “Language” and press **ENTER**.

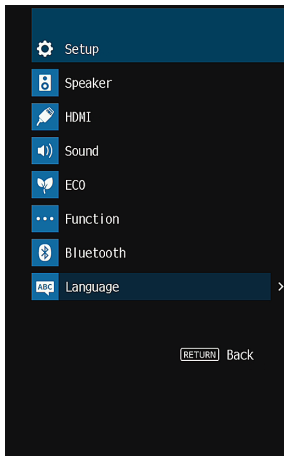

- 5 Use the cursor keys to select the desired language.

6 To exit from the menu, press **SETUP**.

This completes the necessary settings.

Note

The information on the front display is provided in English only.

7 Configuring the necessary speaker settings

Assigning speaker configuration

If you use any of the following speaker configurations, perform the following procedure to configure the corresponding speaker settings manually before performing YPAO.

- Using the bi-amp connection (playing back more high-quality sounds with bi-amp connections)
- Using the surround speakers for front 5.1-channel system (Virtual CINEMA FRONT)

Note

For details on the speaker configurations, see the following:

- “Connecting front speakers that support bi-amp connections” (p.20)
- “Using Virtual CINEMA FRONT” (p.19)

- 1** Press **⏻** (receiver power) to turn on the unit.
- 2** Turn on the TV and switch the TV input to display video from the unit (HDMI OUT jack).
- 3** Press **SETUP**.
- 4** Use the cursor keys to select “Speaker” and press **ENTER**.
- 5** Use the cursor keys to select “Configuration” and press **ENTER**.

6 Configure the corresponding speaker settings.

- Using bi-amp connections, select your speaker system in “Power Amp Assign”. For details, see the following:
 - “Setting your speaker system” (p.67)
- Using the surround speakers for front 5.1-channel system (Virtual CINEMA FRONT), select “On” in “Virtual CINEMA FRONT”. For details, see the following:
 - “Setting the use of Virtual CINEMA FRONT” (p.70)

7 To exit from the menu, press **SETUP**.

This completes the speaker settings.

Optimizing the speaker settings automatically (YPAO)

The Yamaha Parametric room Acoustic Optimizer (YPAO) function detects speaker connections, measures the distances from them to your listening position(s), and then automatically optimizes the speaker settings, such as volume balance and acoustic parameters, to suit your room.

Note

- Use YPAO after connecting a TV and speakers to the unit.
- Configure the corresponding speaker settings manually before performing YPAO. For details on the settings, see the following:
 - “Assigning speaker configuration” (p.26)
- During the measuring process, test tones are output at high volume, and you cannot adjust the volume.
- During the measuring process, keep the room as quiet as possible and do not stand between the speakers and the YPAO microphone for accurate measurement.
- Do not connect headphones.

- 1** Press  (receiver power) to turn on the unit.
- 2** Turn on the TV and switch the TV input to display video from the unit (HDMI OUT jack).
- 3** Turn on the subwoofer and set the volume to half. If the crossover frequency is adjustable, set it to maximum.

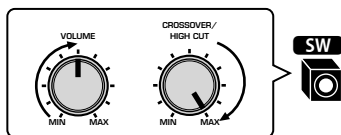

- 4** Place the YPAO microphone at your listening position and connect it to the YPAO MIC jack on the front panel.

Place the YPAO microphone at your listening position (same height as your ears). We recommend the use of a tripod as a microphone stand. You can use the tripod screws to stabilize the microphone.

The unit (front)

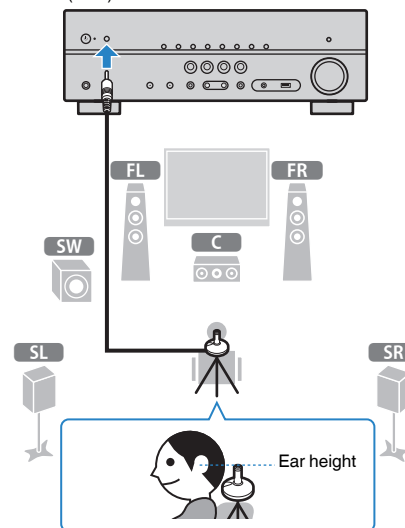

The following screen appears on the TV.

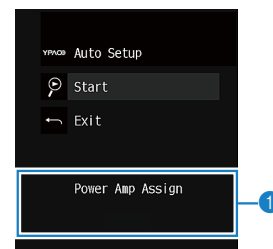

- 1** Setting of “Power Amp Assign” in the “Setup” menu

5 To start the measurement, use the cursor keys to select “Start” and press ENTER.

The measurement will start in 10 seconds. Press ENTER to start the measurement immediately.

The following screen appears on the TV when the measurement finishes.

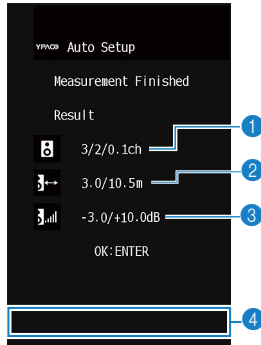

- 1 The number of speakers (front side/rear side/subwoofer)
- 2 Speaker distance (nearest/farthest)
- 3 Adjustment range of speaker output level
- 4 Warning message (if available)

Note

- To stop the measurement temporarily, press RETURN.
- If any error message (such as E-1) or warning message (such as W-1) appears, see the following:
 - “Error messages from YPAO” (p.29)
 - “Warning messages from YPAO” (p.30)
- A speaker with a problem is indicated by blinking of the speaker indicators in the front display.
- If multiple warnings are given (when operating with the front display), use the cursor keys to check the other warning messages.

6 Confirm the results displayed on the screen and press ENTER.

7 Use the cursor keys to select “SAVE” and press ENTER.

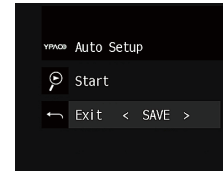

The adjusted speaker settings are applied.

Note

To finish the measurement without applying the result, select “CANCEL”.

8 Disconnect the YPAO microphone from the unit.

This completes optimization of the speaker settings.

Notice

- The YPAO microphone is sensitive to heat, so should not be placed anywhere where it could be exposed to direct sunlight or high temperatures (such as on top of AV equipment).

Error messages from YPAO

If any error message is displayed during the measurement, resolve the problem and perform YPAO again.

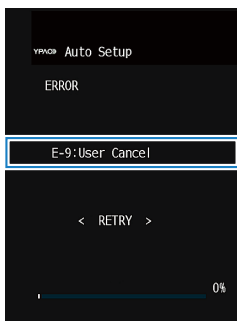

Error message

TV screen



Front display

Error message	Cause	Remedy
E-1:No Front SP (E-1:NO FRNT SP)	Front speakers are not detected.	Exit YPAO, turn off the unit, and then check the speaker connections.
E-2:No Sur. SP (E-2:NO SUR SP)	One of the surround speakers cannot be detected.	
E-5:Noisy (E-5:NOISY)	The noise is too loud.	Keep the room quiet and retry YPAO. If you select "PROCEED", YPAO takes the measurement again and ignores any noise detected.
E-7:No MIC (E-7:NO MIC)	The YPAO microphone has been removed.	Connect the YPAO microphone to the YPAO MIC jack firmly and retry YPAO.
E-8:No Signal (E-8:NO SIGNAL)	The YPAO microphone cannot detect test tones.	Connect the YPAO microphone to the YPAO MIC jack firmly and retry YPAO. If this error occurs repeatedly, contact the nearest authorized Yamaha dealer or service center.
E-9:User Cancel (E-9:CANCEL)	The measurement has been canceled.	Retry or exit YPAO as necessary.
E-10:Internal Err. (E-10:INTERNAL)	An internal error has occurred.	Exit YPAO, and turn off and on the unit. If this error occurs repeatedly, contact the nearest authorized Yamaha dealer or service center.

Note

- Text in parentheses denotes indicators on the front display.
- To exit the YPAO measurement for resolving the problem, use the cursor keys to select "EXIT" and press ENTER.
- For the error messages E-5 and E-9 only, you can proceed with the current YPAO measurement. Press ENTER, and then use the cursor keys to select "PROCEED" and press ENTER.
- To retry the YPAO measurement from beginning, press ENTER, and then use the cursor keys to select "RETRY" and press ENTER.

Warning messages from YPAO

If a warning message is displayed after the measurement, you can still apply the measurement results by following on-screen instructions.

However, we recommend you perform YPAO again in order to use the unit with the optimal speaker settings.

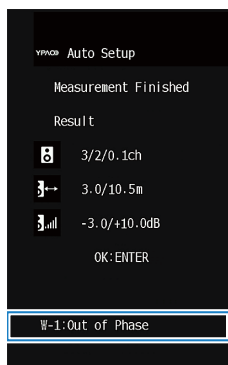

Warning message

TV screen

Problem speaker (blinks)



Front display

Warning message	Cause	Remedy
W-1: Out of Phase (W-1:PHASE)	A speaker cable may be connected with the reverse polarity (+/-).	<p>Check the cable connections (+/-) of the problem speaker.</p> <p>If the speaker is connected incorrectly: Turn off the unit, reconnect the speaker cable.</p> <p>If the speaker is connected correctly: Depending on the type of speakers or room environment, this message may appear even if the speakers are connected correctly. In this case, you can ignore the message.</p>
W-2: Over Distance (W-2:DISTANCE)	A speaker is placed more than 24 m (80 ft) from the listening position.	Exit YPAO, turn off the unit, and place the problem speaker within 24 m (80 ft) of the listening position.
W-3: Level Error (W-3:LEVEL)	There are significant volume differences between the speakers.	Check the usage environment and cable connections (+/-) of each speaker, and the volume of the subwoofer. If there is any problem, exit YPAO, turn off the unit, and then reconnect speaker cable or correct the speaker positions. We recommend using the same speakers or speakers with specifications that are as similar as possible.

Note

Text in parentheses denotes indicators on the front display.

ENJOYING SOUND

Enjoying sound field effects

Select your favorite sound mode

The unit is equipped with a variety of sound programs and surround decoders that allow you to enjoy playback sources with your favorite sound mode (such as sound field effect or stereo playback).

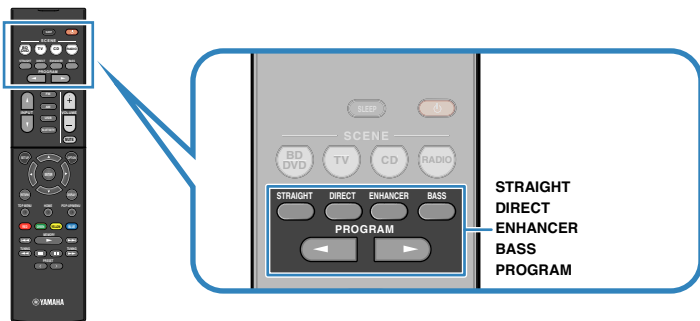

Note

- The sound mode can be applied separately to each input source.
- You can check which speakers are currently outputting sound by looking at the speaker indicators on the front display.
- You can assign the unit's functions of sound mode to the RED/GREEN/YELLOW/BLUE keys of the remote control. For details, see the following:
 - “Setting the unit's functions for the RED/GREEN/YELLOW/BLUE keys of the remote control” (p.81)

Enjoying sound field effects (CINEMA DSP)

CINEMA DSP

The unit is equipped with a variety of sound programs that utilize Yamaha's original DSP technology (CINEMA DSP). It allows you to easily create sound fields like actual movie theaters or concert halls in your room.

Sound program category

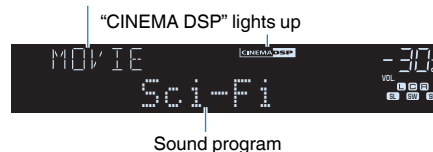

Note

- You can adjust the sound field effect level. For details, see the following:
 - “Adjusting the sound field effect level” (p.56)
- The sound mode can be applied separately to each input source.

Enjoying sound field effects optimized for the type of content

The unit is equipped with a variety of sound programs.

You can enjoy playback sources with your favorite sound mode, such as with a sound field effect added or with stereo playback.

- We recommend a sound program in the “MOVIE” category to enjoy video content.
- We recommend a sound program in the “MUSIC” category to enjoy music content.
- We recommend a sound program in the “STEREO” category to enjoy stereo playback.

For details on the sound programs, see the following:

- “Selecting sound programs” (p.54)

Note

You can select a sound program by pressing PROGRAM.

Enjoying sound field effects without surround speakers (Virtual CINEMA DSP)

If you select one of the sound programs (except 2ch Stereo and 5ch Stereo) when no surround speakers are connected, the unit automatically creates the surround sound field using the front speakers.

Enjoying surround sound with 5 speakers placed in front (Virtual CINEMA FRONT)

You can enjoy the surround sound even when the surround speakers are placed in front.

When “Virtual CINEMA FRONT” in the “Setup” menu is set to “On”, the unit creates the virtual surround speakers in the rear side to allow you to enjoy multichannel surround sound with the 5 speakers placed in the front.

Note

For details on the settings, see the following:

- “Setting the use of Virtual CINEMA FRONT” (p.70)

Enjoying surround sound with headphones (SILENT CINEMA)

SILENT™ CINEMA

You can enjoy surround or sound field effects, like a multichannel speaker system, with stereo headphones by connecting the headphones to the PHONES jack and selecting a sound program or a surround decoder.

Enjoying unprocessed playback

Enjoying original sound (straight decode)

When STRAIGHT is pressed and the straight decode mode is enabled, the unit produces stereo sound from the front speakers for 2-channel sources such as CDs, and produces unprocessed multichannel sounds for multichannel sources.



Each time you press the key, the straight decode mode is enabled or disabled.

Enjoying multichannel playback without sound field effects (surround decoder)

Press PROGRAM to select "Sur.Decode". The previously selected surround decoder is selected. The surround decoder enables multichannel playback from 2-channel sources without sound field effects.

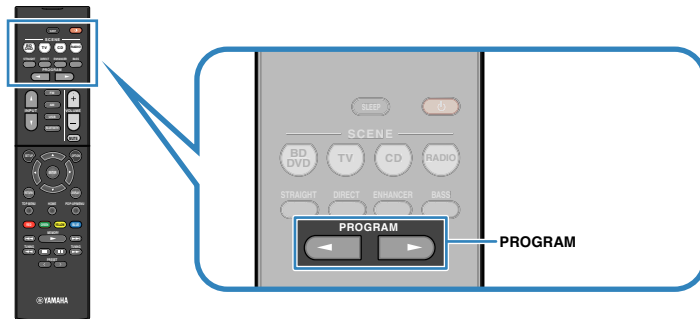

"SUR. DECODE" appears



Note

- You cannot change the previously selected surround decoder by pressing PROGRAM. To change it, use "Sur.Decode" in the "Option" menu. For details, see the following:
 - "Selecting the surround decoder used in the program" (p.55)
- For details on each decoder, see the following:
 - "Glossary of audio decoding format" (p.99)
- You can adjust the surround decoder parameters in "DSP Parameter" in the "Setup" menu. For details, see the following:
 - "Setting the broadening effect of the front sound field" (p.75)
 - "Adjusting the broadening effect of the center sound field" (p.75)
 - "Adjusting the difference in level between the front and surround sound fields" (p.75)
 - "Adjusting the center localization (broadening effect) of the front sound field" (p.75)

Enjoying pure high fidelity sound (direct playback)

When DIRECT is pressed and the direct playback mode is enabled, the unit plays back the selected source with the least circuitry. It allows you to enjoy Hi-Fi sound quality.



Each time you press the key, the direct playback mode is enabled or disabled.

Note

- When the direct playback mode is enabled, the following functions are not available.
 - Selecting sound programs
 - Adjusting the tone control
 - Operating the on-screen “Setup” and “Option” menus
 - Viewing information on the front display (when not in operation)
- When the direct playback mode is enabled, the front display may become dark.

Enjoying enhanced bass sound

Enhancing the bass (Extra Bass)

Press BASS to enable Extra Bass and enjoy enhanced bass sound, regardless of the size of the front speakers and the presence or absence of a subwoofer.

Each time you press the key, Extra Bass is enabled or disabled.

Note

You can also use “Extra Bass” in the “Setup” menu to enable/disable Extra Bass. For details, see the following:

- “Setting the use of Extra Bass” (p.69)

Enjoying enhanced compressed music

Playing back digitally compressed formats with enriched sound (Compressed Music Enhancer)

compressed music **ENHANCER**

Press ENHANCER to enable Compressed Music Enhancer and add depth and breadth to the sound, allowing you to enjoy a dynamic sound close to the original sound before it was compressed. This function can be used along with any other sound modes.

"ENHANCER" lights up



Each time you press the key, Compressed Music Enhancer is enabled or disabled.

Note

- Compressed Music Enhancer does not work on the following audio sources.
 - Signals whose sampling frequency is over 48 kHz
 - DSD audio
- You can also use "Enhancer" in the "Option" menu to enable/disable Compressed Music Enhancer. For details, see the following:
 - "Setting Compressed Music Enhancer" (p.56)

PLAYBACK

Basic playback procedure

Basic procedure for playing back video and music

Basic procedure for playing back video and music is as follows.

- 1 Turn on the external devices (such as a TV or BD/DVD player) connected to the unit.
- 2 Use the input selection keys to select an input source.

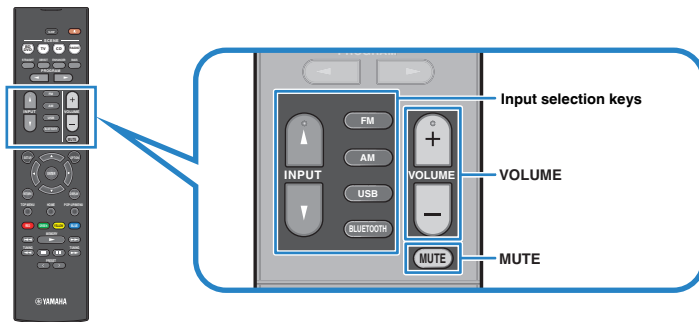

- 3 Start playback on the external device or select a radio station.
- 4 Press **VOLUME** to adjust the volume.

Note

- To mute the audio output, press MUTE. Press MUTE again to unmute.
- Refer to the instruction manual for the external device.

Switching information on the front display

Press INFO on the front panel to select between the various display items on the front display, as shown in the following table.



Item

About 3 seconds after a display item is selected, its corresponding information appears.



Information

Currently input source	Displayed Item
HDMI	
AV	Input (input source name), DSP Program (sound mode name), Audio Decoder (decoder name*)
AUDIO	
AUX	
Bluetooth	Song (song title), Artist (artist name), Album (album name), DSP Program (sound mode name), Audio Decoder (decoder name*)
USB	Frequency (frequency), DSP Program (sound mode name), Audio Decoder (decoder name*) (U.K., Europe and Russia models only) Radio Data System data is also available when the unit is tuned into a Radio Data System broadcasting station. For details, see the following: <ul style="list-style-type: none">• "Displaying the Radio Data System information" (p.44)
TUNER	

* The name of the audio decoder currently activated is displayed. If no audio decoder is activated, "Decoder Off" appears.

Note

Available items vary depending on the selected input source. The displayed item can also be applied separately to each input source.

Item names and functions of the playback screen

The item names and functions of the playback screen, available when your TV is connected to the unit via HDMI, are as follows.

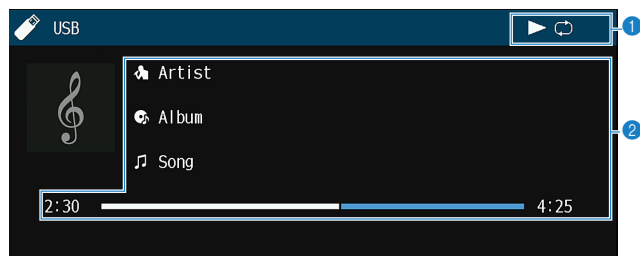

1 Status indicators

Display the current repeat/random settings and playback status (such as play/pause).

2 Playback information

Displays the artist name, album name, song title, and elapsed time.

Use the following remote control keys to control playback.

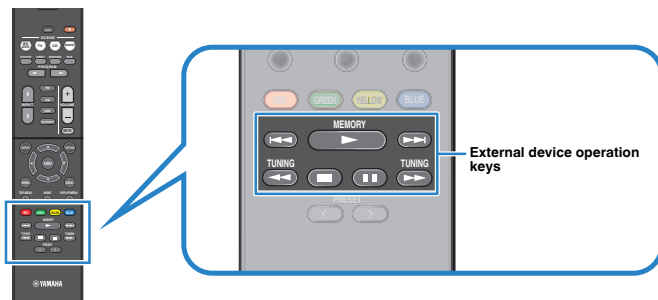

External device operation keys	Function
	Resumes playback from pause or starts playback of the previously selected song.
	Stops playback.
	Stops playback temporarily.
	Skips forward/backward.
	Searches forward/backward (by holding down).

Note

Displayed items vary depending on the content of playback.

Item names and functions of the browse screen

The item names and functions of the browse screen, available when your TV is connected to the unit via HDMI, are as follows. The browse screen appears when the next input source is selected.

- USB

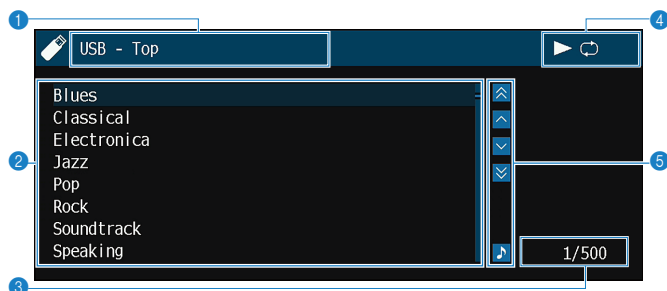

1 List name

2 Contents list

Displays the list of contents. Use the cursor keys to select an item and press ENTER to confirm the selection.

3 Item number/total

4 Status indicators

Display the current repeat/random settings and playback status (such as play/pause).

5 Operation menu

Use the cursor keys to select an item. Press ENTER to confirm the selection.

Icon	Function
	Moves 10 pages backward.
	Moves to the previous page of the list.
	Moves to the next page of the list.
	Moves 10 pages forward.
	Moves to the playback screen.

Note

- Displayed items vary depending on the content of playback.
- A content selected by the cursor is displayed on the front display.

Listening to FM/AM radio

Setting the frequency steps

(Asia, Taiwan, Brazil and Central and South America models only)

At the factory, the frequency step setting is set to 50 kHz for FM and 9 kHz for AM. Depending on your country or region, set the frequency steps to 100 kHz for FM and 10 kHz for AM.

- 1 Set the unit to standby mode.**
- 2 When holding down STRAIGHT on the front panel, press  (power).**

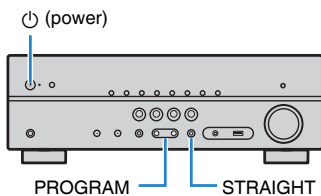

- 3 Press PROGRAM to select “TU”.**

TU FM50/AM9

- 4 Press STRAIGHT to select “FM100/AM10”.**

- 5 Press  (power) to set the unit to standby mode and turn it on again.**

This completes the settings.

Selecting a frequency for reception

You can tune into a radio station by specifying its frequency.

Note

The radio frequencies differ depending on the country or region where the unit is being used. The explanation of this section uses a display with frequencies used in U.K., Europe and Russia models.

1 Press FM or AM to select “TUNER” as the input source.

“TUNER” is selected as the input source and the frequency currently selected is displayed on the front display.



2 Press TUNING to set a frequency.

Hold down the key for about a second to search stations automatically.

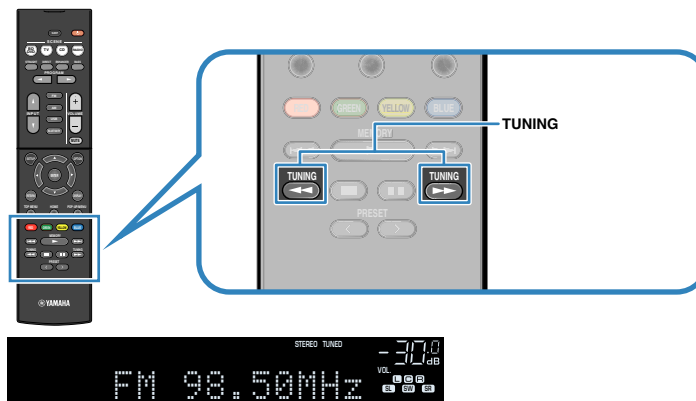

On the front display, “TUNED” lights up when the unit is receiving an FM/AM radio station signal.

“STEREO” lights up when the unit is receiving a stereo FM radio signal.

Note

You can watch videos input from external devices while listening to radio. For details, see the following:

- “Selecting a video source to be output with the selected audio source” (p.59)

Selecting a preset station

Tune into a registered radio station by selecting its preset number.

1 Press FM or AM to select “TUNER” as the input source.

“TUNER” is selected as the input source and the frequency currently selected is displayed on the front display.

2 Press PRESET to select the desired radio station.

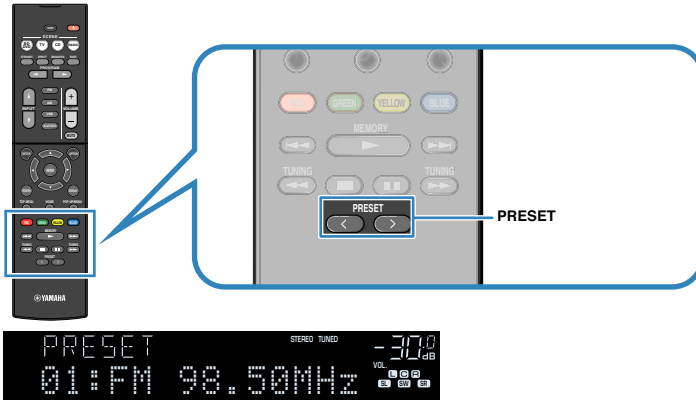

Note

“No Presets” appears on the front display when no radio stations are registered.

Registering radio stations automatically (Auto Preset)

Automatically register FM radio stations with strong signals.

Note

- You can register up to 40 radio stations as presets.
- To register AM radio stations, see the following:
 - “Registering a radio station manually” (p.43)
- (U.K., Europe and Russia models only)
Only Radio Data System broadcasting stations are registered automatically by the Auto Preset function.

1 Press FM to select “TUNER” as the input source.

“TUNER” is selected as the input source and the frequency currently selected is displayed on the front display.

2 Press OPTION.

3 Use the cursor keys to select “Preset” and press ENTER.



The preset number from which to start the registration is displayed on the front display.

Note

To specify the preset number from which to start the registration, press cursor keys or PRESET to select a preset number.

4 To start the Auto Preset process, press ENTER.

“SEARCH” appears during Auto Preset



Preset number from which to start the registration

The Auto Preset process starts and “SEARCH” appears during Auto Preset.

Note

To cancel the Auto Preset process, press RETURN.

When the Auto Preset process finishes, “FINISH” appears on the front display and the “Option” menu closes automatically.



Registering a radio station manually

Select a radio station manually and register it to a preset number.

Note

You can register up to 40 radio stations as presets.

1 Press FM or AM to select “TUNER” as the input source.

“TUNER” is selected as the input source and the frequency currently selected is displayed on the front display.

2 Press TUNING to set a frequency.

Hold down the key for about a second to search stations automatically.

3 Hold down MEMORY for a few seconds.

The first time that you do register a station, the selected radio station will be registered to the preset number “01”. Thereafter, each radio station you select will be registered to the next empty (unused) preset number after the most recently registered number.

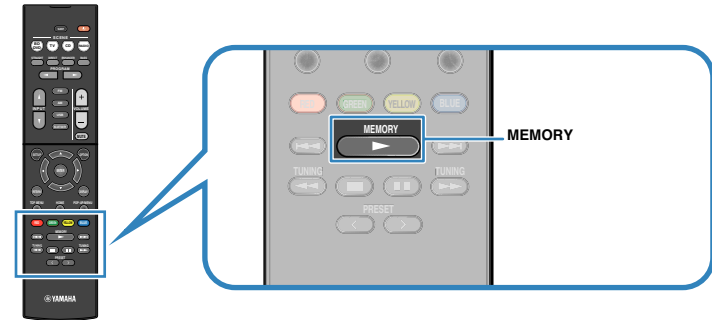

Preset number

Note

To select a preset number for registering, press MEMORY once after tuning into the desired radio station, press PRESET to select a preset number, and then press MEMORY again.



“Empty” (not in use) or the frequency currently registered

This completes the registers.

Clearing preset stations

Clear radio stations registered to the preset numbers.

1 Press FM or AM to select “TUNER” as the input source.

“TUNER” is selected as the input source and the frequency currently selected is displayed on the front display.

2 Press OPTION.

3 Use the cursor keys to select “Preset” and press ENTER.



4 Use the cursor keys to select “CLEAR”.

5 Use the cursor keys to select a preset station to be cleared and press ENTER.



Preset station to be cleared

If the preset station is cleared, “Cleared” appears and then the next in-use preset number is displayed.



6 Repeat step 5 until all desired preset stations are cleared.

7 Press OPTION.

This completes the clearing preset stations.

Displaying the Radio Data System information

(U.K., Europe and Russia models only)

Radio Data System is a data transmission system used by FM stations in many countries. The unit can receive various types of Radio Data System data, such as “Program Service”, “Program Type”, “Radio Text” and “Clock Time”, when it is tuned into a Radio Data System broadcasting station.

1 Tune into the desired Radio Data System broadcasting station.

Note

We recommend using “Auto Preset” to tune into the Radio Data System broadcasting stations. For details, see the following:

- “Registering radio stations automatically (Auto Preset)” (p.42)

2 Press INFO on the front panel to select between the various display items.



Item name

About 3 seconds after a display item is selected, its corresponding information appears.



Information

Program Service	Program service name
Program Type	Current program type
Radio Text	Information on the current program
Clock Time	Current time
DSP Program	Sound mode name
Audio Decoder	Decoder name
Frequency	Frequency

Note

“Program Service”, “Program Type”, “Radio Text”, and “Clock Time” are not displayed if the radio station does not provide the Radio Data System service.

Receiving traffic information automatically

(U.K., Europe and Russia models only)

When “TUNER” is selected as the input source, the unit automatically receives traffic information. To enable this function, perform the following procedure to set the traffic information station.

- 1 When “TUNER” is selected as the input source, press OPTION.**
- 2 Use the cursor keys to select “Traffic Program” and press ENTER.**

The traffic information station search will start in 5 seconds. Press ENTER again to start the search immediately.

Note

- To search upward/downward from the current frequency, press the cursor keys while “READY” is displayed.
- To cancel the search, press RETURN.

The following screen appears for about 3 seconds when the search finishes.



Traffic information station (frequency)

Note

“TP Not Found” appears for about 3 seconds when no traffic information stations are found.

Playing back music stored on a Bluetooth® device

Connecting a Bluetooth® device (pairing)

When connecting a Bluetooth device to the unit for the first time, a pairing operation is required. Pairing is an operation that registers the Bluetooth devices with each other beforehand. Once pairing has been completed, subsequent reconnection will be easy even after the Bluetooth connection is disconnected.

Note

- To use the Bluetooth function, turn on the Bluetooth function of a Bluetooth device.
- To use the Bluetooth function, set “Bluetooth” in the “Setup” menu to “On”. For details, see the following:
 - “Setting the use of Bluetooth®” (p.82)

1 Press BLUETOOTH to select “Bluetooth” as the input source.

2 Hold down MEMORY on the front panel or the remote control for a few seconds.

“Searching...” appears on the front display.

Note

- You can also use the “Option” menu to pair a Bluetooth device. Press OPTION, and then use the cursor keys to select “Pairing”. For details, see the following:
 - “Performing pairing with a Bluetooth® device” (p.62)
- If another Bluetooth device is already connected, disconnect the Bluetooth connection before you perform a pairing operation.
- To cancel pairing, press MEMORY.

3 Turn on the Bluetooth function on your device.

4 From the Bluetooth device list on your device, select “***** Yamaha” (*****: model name of the unit).

After pairing has been completed and the unit is connected to the Bluetooth device, “Connected” appears on the front display. While a Bluetooth connection is established, the Bluetooth indicators light up.



Note

- If you are prompted to input a passkey during a pairing procedure, input the numerals “0000”.
- Complete a pairing procedure within 30 seconds.
- If no Bluetooth devices are found, “Not found” appears on the front display.

Playback of Bluetooth® device contents

You can play back music files stored on a Bluetooth device (such as smartphones) on the unit.

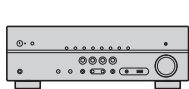

The unit



Bluetooth device
(such as smartphones)

Note

- Confirm beforehand that the pairing has been completed.
 - “Connecting a Bluetooth® device (pairing)” (p.46)
- To use the Bluetooth function, turn on the Bluetooth function of a Bluetooth device.
- To use the Bluetooth function, set “Bluetooth” in the “Setup” menu to “On”. For details, see the following:
 - “Setting the use of Bluetooth®” (p.82)
- For details on supported Bluetooth devices, see the following:
 - “Supported Bluetooth® devices” (p.101)

1 On the Bluetooth device, select the unit (name of the unit).

When a connection is established, the unit’s input source automatically switches to “Bluetooth”.

Note

- If you do not want the input source to switch automatically when a connection is established, set “Input Interlock” to “Off” in the “Option” menu. For details, see the following:
 - “Enabling automatic switching of the input source when Bluetooth® connects” (p.63)
- You can operate the unit to search and connect the Bluetooth device (only the most recently connected device). In that case, follow one of the procedures below.
 - Switch the input source to “Bluetooth”.
 - Press ENTER while the input source is “Bluetooth”. Otherwise, press OPTION and use the cursor keys to select “Connect”.
- If you cannot connect the device, please perform pairing again.

2 Operate the Bluetooth device to play back music.

Note

- You cannot operate the unit to select or play back music, or display informations such as song names.
- Follow one of the procedures below to disconnect a Bluetooth connection.
 - Perform the disconnect operation on the Bluetooth device.
 - Press ENTER.
 - Press OPTION and use the cursor keys to select “Disconnect”.
 - Switch the unit’s input source to other than “Bluetooth”.
 - Press the SETUP key, then use the cursor keys to select “Bluetooth”, then “Disconnect”.

Enjoying audio using Bluetooth® speakers/ headphones

You can enjoy audio played back on the unit using Bluetooth speakers/headphones.

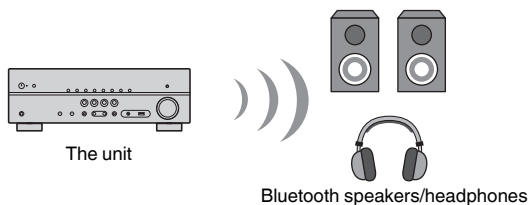

Note

- Sounds will be also output from the speakers connected to the unit.
- You cannot play back music files stored on a Bluetooth device (such as smartphones).

1 Use the input selection keys on the remote control to select an input source.

Select an input source other than Bluetooth.

2 Press SETUP.

3 Use the cursor keys to select “Bluetooth” and press ENTER.

4 Use the cursor keys to select “Transmitter” and then set to “On”.

5 Use the cursor keys to select “Device Search” and press ENTER to search the Bluetooth devices.

The list of Bluetooth devices is displayed.

6 Use the cursor keys to select the Bluetooth speakers/headphones to be connected with the unit and press ENTER.

When the connection process finishes, “Completed” appears and audio played back on the unit will be reproduced from the Bluetooth speakers/headphones.

Note

If the desired Bluetooth device is not displayed on the list, set the Bluetooth device to the pairing mode and then perform “Device Search” operation again.

7 Press ENTER.

This completes the settings.

Note

To terminate the Bluetooth connection, perform one of the following operations.

- Perform the disconnect operation on the Bluetooth speakers/headphones.
- Press the SETUP key, then use the cursor keys to select “Bluetooth”, then “Transmitter”, and then “Off”.

Playing back music stored on a USB storage device

Playback of USB storage device contents

You can play back music files stored on a USB storage device on the unit.

Note

For details on playable USB devices and USB file formats, see the following:

- “Supported USB devices” (p.101)
- “Supported file formats” (p.101)

1 Connect the USB storage device to the USB jack.

The unit (front)

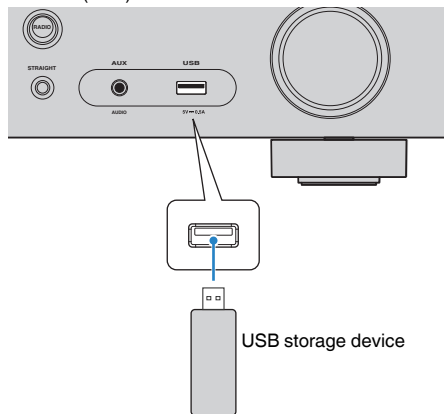

Note

- If the USB storage device contains many files, it may take time to load them. In this case, “Loading...” appears on the front display.
- Stop playback of the USB storage device before disconnecting it from the USB jack.
- Connect a USB storage device directly to the USB jack of the unit. Do not use extension cables.
- The unit cannot charge USB devices while it is in standby mode.

2 Press USB to select “USB” as the input source.

The browse screen is displayed on the TV.

Note

If playback is ongoing on your USB storage device, the playback screen is displayed.

3 Use the cursor keys to select an item and press ENTER.

If a song is selected, playback starts and the playback screen is displayed.

Note

To switch the screen mode browse/playback/off, press DISPLAY.

Note

You can configure the repeat settings for playback of contents. For details, see the following:

- “Configuring the repeat setting” (p.61)

Useful playback functions

SCENE function

Selecting the input source and favorite settings with one touch (SCENE)

The SCENE function allows you to select the following settings with just one touch.

- Input source
- Sound program
- Compressed Music Enhancer On/Off
- SCENE link playback

You can register four SCENE functions that are assigned to four SCENE keys on the remote control respectively.

Selecting a registered scene

Press SCENE, and then the input source and settings registered to the corresponding scene are selected. The unit turns on automatically when it is in standby mode.

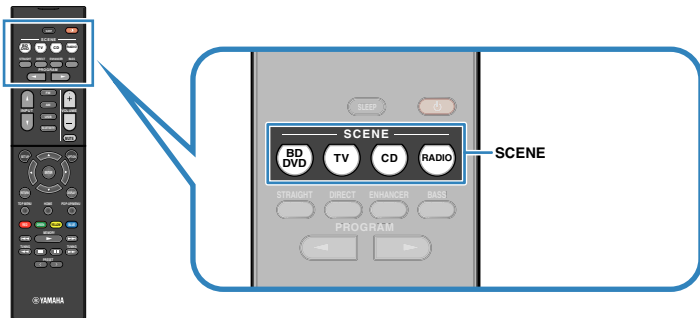

By default, the following settings are registered for each scene.

SCENE	BD DVD	TV	CD	RADIO
Input	HDMI1	AUDIO1	AUDIO2	TUNER
Sound program	MOVIE (Sci-Fi)	STRAIGHT	STRAIGHT	STEREO (5ch Stereo)
Compressed Music Enhancer	Off	On	Off	On
SCENE link playback	On	On	Off	Off

Note

- For details on the sound program and Compressed Music Enhancer, see the following:
 - “Enjoying sound field effects optimized for the type of content” (p.31)
 - “Playing back digitally compressed formats with enriched sound (Compressed Music Enhancer)” (p.35)
- The SCENE link playback function allows you to automatically turn on the TV or start playback of an external device connected to the unit via HDMI, in conjunction with a scene selection. For details, see the following:
 - “Setting the use of SCENE link playback” (p.74)

■ Registering a scene

You can change the default setting and register the function that is assigned to each SCENE key.

Note

We recommend registering the scene with playing back the content that you want to register.

1 Perform the following operations to prepare the settings you want to assign to a scene.

- Select an input source
- Select a sound program or straight decode
- Enable/disable Compressed Music Enhancer
- Enable/disable SCENE link playback

2 Hold down the desired SCENE key until “SET Complete” appears on the front display.



This completes the registers.

Note

For details on the settings, see the following:

- “Enjoying sound field effects optimized for the type of content” (p.31)
- “Playing back digitally compressed formats with enriched sound (Compressed Music Enhancer)” (p.35)
- “Setting the use of SCENE link playback” (p.74)

Configuring playback settings for different playback sources (Option menu)

Basic operation of the Option menu

Perform the following basic procedure to operate the “Option” menu. With the “Option” menu, you can configure different playback settings according to the input source currently being played back.

1 Press OPTION.

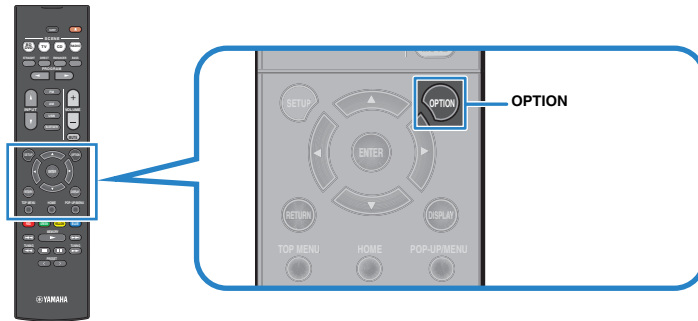

Front display

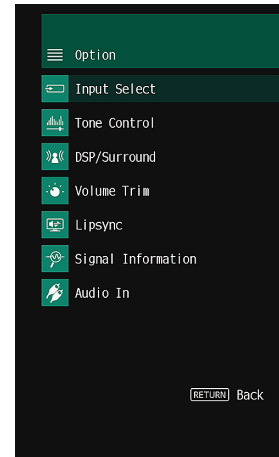

TV screen

- 2 Use the cursor keys to select an item and press ENTER.
- 3 Use the cursor keys to select a setting.
- 4 Press OPTION.

This completes the settings.

Note

For details on the default settings, see the following:

- “Default settings of the Option menu” (p.110)

Option menu items

Use the following table to configure playback settings of the unit.

Note

- Available items vary depending on the selected input source.
- Text in parentheses denotes indicators on the front display.

Item	Function	Page
Input Select (Input Select)	Switches the input source.	p.53
Tone Control (Tone Control)	Adjusts the level of high-frequency range and low-frequency range individually.	p.53
	Program (PRG) Select the sound programs and stereo playback.	p.54
	Sur.Decode (SrDec) Select which surround decoder is used when Sur.Decode is selected as the program.	p.55
DSP/Surround (DSP/Surround)	DSP Level (DSP Level) Adjusts the sound field effect level.	p.56
	Adaptive DRC (A.DRC) Sets whether the dynamic range (from maximum to minimum) is automatically adjusted to the volume.	p.56
	Enhancer (Enhancer) Enables/disables Compressed Music Enhancer.	p.56
Volume Trim (Volume Trim)	Input Trim (In.Trim) Corrects volume differences between input sources.	p.56
	Subwoofer Trim (SW.Trim) Fine-adjusts the subwoofer volume.	p.56
Lipsync (Lipsync)	Enables/disables the "Lipsync" setting in the "Setup" menu.	p.57
Signal Information (Signal Info.)	Displays information about the video/audio signals.	p.57
Audio In (Audio In)	Combines the video of the selected input source with the audio of a different input source.	p.57
Video Out (Video Out)	Selects a video source to be output together with the selected audio source.	p.59
FM Mode (FM Mode)	Switches between "Stereo" and "Monaural" for FM radio reception.	p.59
	Auto Preset (AUTO) Automatically registers FM radio stations with strong signals as presets.	p.59
Preset (Preset)	Clear Preset (CLEAR) Clear radio stations registered to preset numbers.	p.60
Traffic Program (TrafficProgram)	(U.K., Europe and Russia models only) Automatically searches for a traffic information station.	p.60
Repeat (Repeat)	Configures the repeat setting.	p.61

Item	Function	Page
Pairing (Pairing)	Performs a pairing operation between the unit and your Bluetooth device.	p.62
Connect/Disconnect (Connect/Disconnect)	Connects/disconnects the Bluetooth device.	p.62
Input Interlock (Interlock)	Sets whether the input source automatically switches to "Bluetooth" when a Bluetooth connection is established.	p.63

Switching the input source

Switches the input source. Press ENTER to switch to the selected input source.

Option menu

"Input Select"

Adjusting the tone of the audio output

Adjusts the level of high-frequency range (Treble) and low-frequency range (Bass) individually.

Option menu

"Tone Control"

Choices

Treble, Bass

Setting range

-6.0 dB to +6.0 dB (0.5 dB increments)

Note

- When both "Treble" and "Bass" are 0.0 dB, "Bypass" appears.
- You can also adjust the tone with the front panel controls. Press TONE CONTROL to select "Treble" or "Bass", then press PROGRAM to make an adjustment.
- If you set an extreme value, sounds may not match those from other channels.

Configuring DSP/Surround

Selecting sound programs

Select sound programs and stereo playback.

Note

You can select a sound program by pressing PROGRAM.

Option menu

"DSP/Surround" > "Program"

MUSIC

Hall in Munich	This program simulates a Munich concert hall with approximately 2,500 seats that uses stylish wood for the interior finishing. Fine, beautiful reverberations spread richly, creating a calming atmosphere. The listener's virtual seat is at the center left of the arena.
Hall in Vienna	This program simulates a 1700-seat, middle-sized concert hall with a shoebox shape that is traditional in Vienna. Pillars and ornate carvings create extremely complex reverberations from all around the audience, producing a very full, rich sound.
Chamber	This program creates a relatively wide space with a high ceiling, like an audience hall in a palace. It offers pleasant reverberations that are suitable for courtly music and chamber music.
Cellar Club	This program simulates an intimate concert venue with a low ceiling and homey atmosphere. A realistic, live sound field delivers powerful sounds that make you feel as if you are sitting in the front row in front of a small stage.
The Roxy Theatre	This program creates the sound field of a 460-seat rock music concert venue in Los Angeles. The listener's virtual seat is at the center left of the hall.
The Bottom Line	This program creates the sound field at stage front in The Bottom Line, a famous New York jazz club once. The floor can seat 300 people to the left and right in a sound field offering real and vibrant sound.

MOVIE

Sports	This program allows listeners to enjoy the rich vividness of sport broadcasts and light entertainment programs. In sports broadcasts, the commentators' voices are positioned clearly at the center, while the atmosphere inside the stadium is realistically conveyed by the peripheral delivery of the sounds of the fans in a suitable space.
Action Game	This program is suitable for action games, such as car racing and fighting games. The reality of, and emphasis on, various effects makes the player feel like they are right in the middle of the action, allowing for greater concentration. Use this program in combination with Compressed Music Enhancer for a more dynamic and strong sound field.
Roleplaying Game	This program is suitable for role-playing and adventure games. This program adds depth to the sound field for natural and realistic reproduction of background music, special effects, and dialogue from a wide variety of scenes. Use this program in combination with Compressed Music Enhancer for a clearer and more spatial sound field.
Music Video	This program allows you to enjoy videos of pop, rock, and jazz concerts, as if you were there yourself. Immerse yourself in the hot concert atmosphere thanks to the vividness of the singers and solos on stage, a presence sound field that emphasizes the beat of rhythm instruments, and a surround sound field that reproduces the space of a big live hall.
Standard	This program creates a sound field that emphasizes the surround feeling without disturbing the original acoustic positioning of multichannel audio. Its design is based on the concept of the ideal movie theater, in which the audience is surrounded by beautiful reverberations from the left, right, and rear.
Spectacle	This program delivers the scale and grandeur of spectacular movie productions. It delivers an expansive sound space to match the cinemascope wide-screen, and boasts a broad dynamic range, providing everything from small delicate sounds to powerful loud booms.
Sci-Fi	This program clearly reproduces the finely elaborated sound design of the latest Sci-Fi and SFX movies. You can enjoy a variety of cinematographically created virtual spaces reproduced with clear separation between dialogue, sound effects, and background music.
Adventure	This program is ideal for reproducing the sound design of action and adventure movies precisely. The sound field restrains reverberations, but puts emphasis on reproducing a sensation of expansiveness on both sides, powerful space expanded widely to the left and right. The restrained depth creates a clear and powerful space, while also maintaining the articulation of the sounds and the separation of the channels.
Drama	This program features stable reverberations that match a wide range of movie genres, from serious dramas to musicals and comedies. The reverberations are modest, but suitably stereophonic. The sound effects and background music are reproduced with a gentle echo that does not impinge on the articulation of the dialogue. You'll never get tired listening for long periods.

Mono Movie	This program reproduces monaural video sources, such as classic movies, in an atmosphere of a good old movie theater. The program creates a pleasant space with depth, by adding breadth and the appropriate reverberation to the original audio.
-------------------	---

STEREO

2ch Stereo	Use this program to mix down multichannel sources to 2 channels. When multichannel signals are input, they are down mixed to 2 channels and output from the front speakers (this program does not utilize CINEMA DSP).
-------------------	--

5ch Stereo	Use this program to output sound from all speakers. When you play back multichannel sources, the unit mixes down the source to 2 channels, and then outputs the sound from all speakers. This program creates a larger sound field and is ideal for background music at parties.
-------------------	--

UNPROCESSED

Sur.Decode	The surround decoder enables multichannel playback from 2-channel sources without sound field effects.
-------------------	--

Straight	When the straight decode mode is enabled, the unit produces stereo sound from the front speakers for 2-channel sources such as CDs, and produces unprocessed multichannel sounds for multichannel sources.
-----------------	--

Note

For details on "Sur.Decode", see the following:

- "Selecting the surround decoder used in the program" (p.55)

Selecting the surround decoder used in the program

Select the surround decoder used when "Sur.Decode" is selected in "Program" in the "Option" menu or selected by pressing PROGRAM.

Note

For details on "Program" in the "Option" menu, see the following:

- "Selecting sound programs" (p.54)

Option menu

"DSP/Surround" > "Sur.Decode"

Settings

DPL Movie	Uses the Dolby Pro Logic II decoder suitable for movies.
DPL Music	Uses the Dolby Pro Logic II decoder suitable for music.
DPL Game	Uses the Dolby Pro Logic II decoder suitable for games.
Neo:6 Cinema	Uses the DTS Neo: 6 decoder suitable for movies.
Neo:6 Music	Uses the DTS Neo: 6 decoder suitable for music.

Note

- For details on each decoder, see the following:
 - "Glossary of audio decoding format" (p.99)
- You can adjust the surround decoder parameters in "DSP Parameter" in the "Setup" menu. For details, see the following:
 - "Setting the broadening effect of the front sound field" (p.75)
 - "Adjusting the broadening effect of the center sound field" (p.75)
 - "Adjusting the difference in level between the front and surround sound fields" (p.75)
 - "Adjusting the center localization (broadening effect) of the front sound field" (p.75)

■ Adjusting the sound field effect level

Adjusts the sound field effect level.

Option menu

"DSP/Surround" > "DSP Level"

Setting range

-6 dB to +3 dB (1 dB increments)

■ Adjusting the dynamic range automatically

Sets whether the dynamic range (from maximum to minimum) is automatically adjusted when the volume level is adjusted. When it is set to "On", the dynamic range becomes narrow at a low volume and wide at a high volume. It is useful for listening to playback at a low volume at night.

Option menu

"DSP/Surround" > "Adaptive DRC"

Settings

Off	The dynamic range is not automatically adjusted.
On	Automatically adjusts the dynamic range.

■ Setting Compressed Music Enhancer

Enables/disables Compressed Music Enhancer.

Option menu

"DSP/Surround" > "Enhancer"

Settings

Off	Disables Compressed Music Enhancer.
On	Enables Compressed Music Enhancer.

Note

- This setting is applied separately to each input source.
- You can also use ENHANCER on the remote control to enable/disable Compressed Music Enhancer.
- For details on Compressed Music Enhancer, see the following:
 - "Playing back digitally compressed formats with enriched sound (Compressed Music Enhancer)" (p.35)

Correcting volume differences during playback

■ Correcting volume differences between input sources

Corrects volume differences between input sources. If you are bothered by volume differences when switching between input sources, use this function to correct it.

Option menu

"Volume Trim" > "Input Trim"

Setting range

-6.0 dB to +6.0 dB (0.5 dB increments)

Note

This setting is applied separately to each input source.

■ Adjusting the subwoofer volume

Fine-adjusts the subwoofer volume.

Option menu

"Volume Trim" > "Subwoofer Trim"

Setting range

-6.0 dB to +6.0 dB (0.5 dB increments)

Enabling Lipsync adjustment

Enables/disables the adjustment configured in "Lipsync" in the "Setup" menu.

Note

For details on "Lipsync" in the "Setup" menu, see the following:

- "Setting the adjustment method of the Lipsync function" (p.76)

Option menu

"Lipsync"

Settings

Off	Disables the "Lipsync" adjustment.
On	Enables the "Lipsync" adjustment.

Note

This setting is applied separately to each input source.

Checking information about the video/audio signals

Displays information about the video/audio signals.

Option menu

"Signal Information"

Format	Audio format of the input signal
Channel	The number of source channels in the input signal (front/surround/LFE) For example, "3/2/0.1" means 3 front channels, 2 surround channels, and LFE.
Sampling	The number of samples per second of the input digital signal
Video In	Type and resolution of the input digital signal
Video Out	Type and resolution of the output digital signal

Note

To switch the information on the front display, press the cursor keys.

Combining audio of another input source with video of the current input source

Select the audio of a different input source to play back together with the video of the currently selected input source. For example, use this function in the following cases.

- Connecting a playback device that supports HDMI video output, but not HDMI audio output

Option menu

"Audio In"

Input sources

HDMI 1-4, AV 1-3

Settings

AV 1-3, AUDIO 1-2

Video/audio input jacks available on the unit

Output jacks on video device		Input jacks on the unit	
Video	Audio	Video	Audio
HDMI	Digital optical	HDMI 1-4	AUDIO 1 (OPTICAL)
	Digital coaxial	HDMI 1-4	AUDIO 2 (COAXIAL) AV 1 (COAXIAL)
	Analog stereo	HDMI 1-4	AV 2-3 (AUDIO)
Composite video	Digital optical	AV 1-3 (VIDEO)	AUDIO 1 (OPTICAL)

Necessary setting

For example, if you have connected a video device to AV 2 (VIDEO) and AUDIO 1 (OPTICAL) jack of the unit, change the combination setting as follows.

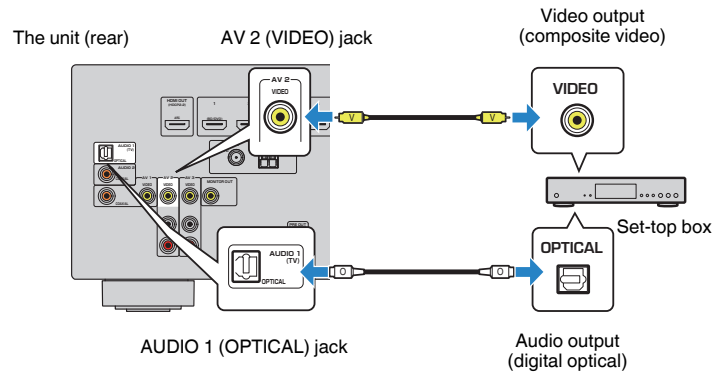

1 Press INPUT to select “AV 2” (video input jack to be used) as the input source.

2 Press OPTION.

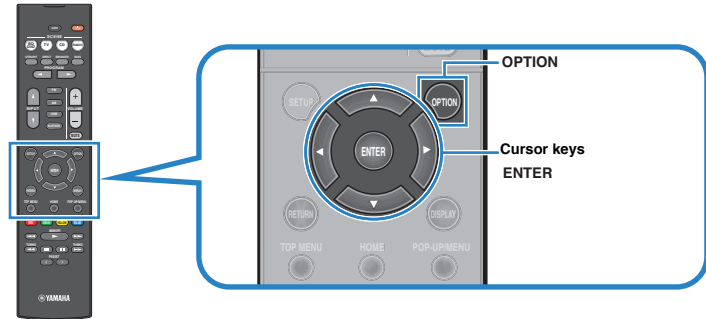

3 Use the cursor keys to select “Audio In” and press ENTER.



4 Use the cursor keys to select “AUDIO 1” (audio input jack to be used).



5 Press OPTION.

This completes the necessary settings.

Selecting a video source to be output with the selected audio source

Selects a video source to be output together with the selected audio source. For example, you can watch the video from a different source while listening to the radio.

Option menu

"Video Out"

Input sources

AUX, AUDIO 1-2, TUNER, Bluetooth, USB

Settings

Off	Does not output video.
HDMI 1-4, AV 1-3	Outputs video input through the corresponding video input jacks.

Switching between stereo and monaural for FM radio reception

Switch between stereo and monaural for FM radio reception. When the signal reception for an FM radio station is unstable, switching to monaural may improve it.

Option menu

"FM Mode"

Settings

Stereo	Enables stereo for FM radio reception.
Monaural	Enables monaural for FM radio reception.

Setting presets for radio stations

■ Registering radio stations automatically

Automatically register FM radio stations with strong signals.

Note

- You can register up to 40 radio stations as presets.
- To register AM radio stations, see the following:
 - "Registering a radio station manually" (p.43)
- (U.K., Europe and Russia models only)
Only Radio Data System broadcasting stations are registered automatically by the Auto Preset function.

Option menu

"Preset" > "Auto Preset"

1 Press FM to select "TUNER" as the input source.

"TUNER" is selected as the input source and the frequency currently selected is displayed on the front display.

2 Press OPTION.

3 Use the cursor keys to select "Preset" and press ENTER.



The preset number from which to start the registration is displayed on the front display.

Note

To specify the preset number from which to start the registration, press cursor keys or PRESET to select a preset number.

4 To start the Auto Preset process, press ENTER.

"SEARCH" appears during Auto Preset



Preset number from which to start the registration

The Auto Preset process starts and "SEARCH" appears during Auto Preset.

Note

To cancel the Auto Preset process, press RETURN.

When the Auto Preset process finishes, "FINISH" appears on the front display and the "Option" menu closes automatically.



■ Clearing preset stations

Clear radio stations registered to the preset numbers.

Option menu

"Preset" > "Clear Preset"

1 Press FM or AM to select "TUNER" as the input source.

"TUNER" is selected as the input source and the frequency currently selected is displayed on the front display.

2 Press OPTION.

3 Use the cursor keys to select "Preset" and press ENTER.



4 Use the cursor keys to select "CLEAR".

5 Use the cursor keys to select a preset station to be cleared and press ENTER.



Preset station to be cleared

If the preset station is cleared, "Cleared" appears and then the next in-use preset number is displayed.



6 Repeat step 5 until all desired preset stations are cleared.

7 Press OPTION.

This completes the clearing preset stations.

Receiving traffic information automatically

(U.K., Europe and Russia models only)

When "TUNER" is selected as the input source, the unit automatically searches for a traffic information station.

Option menu

"Traffic Program"

1 When "TUNER" is selected as the input source, press OPTION.

2 Use the cursor keys to select “Traffic Program” and press ENTER.

The traffic information station search will start in 5 seconds. Press ENTER again to start the search immediately.

Note

- To search upward/downward from the current frequency, press the cursor keys while “READY” is displayed.
- To cancel the search, press RETURN.

The following screen appears for about 3 seconds when the search finishes.



Traffic information station (frequency)

Note

“TP Not Found” appears for about 3 seconds when no traffic information stations are found.

Configuring the repeat setting

Configure the repeat setting for playback.

Option menu

“Repeat”

Settings

Off	Turns off the repeat function.
One	Plays back the current song repeatedly.
All	Plays back all songs in the current album (folder) repeatedly.
Random	Plays back songs in random order.

Performing pairing with a Bluetooth® device

When connecting a Bluetooth device to the unit for the first time, a pairing operation is required. Pairing is an operation that registers the Bluetooth devices with each other beforehand. Once pairing has been completed, subsequent reconnection will be easy even after the Bluetooth connection is disconnected.

Note

- To use the Bluetooth function, turn on the Bluetooth function of a Bluetooth device.
- To use the Bluetooth function, set “Bluetooth” in the “Setup” menu to “On”. For details, see the following:
 - “Setting the use of Bluetooth®” (p.82)

Option menu

“Pairing”

- 1 Press BLUETOOTH to select “Bluetooth” as the input source.**
- 2 Press OPTION.**
- 3 Use the cursor keys to select “Pairing” and press ENTER.**

“Searching...” appears on the front display.

Note

- If another Bluetooth device is already connected, disconnect the Bluetooth connection before you perform a pairing operation.
- To cancel pairing, press MEMORY.

- 4 Turn on the Bluetooth function on your device.**
- 5 From the Bluetooth device list on your device, select “***** Yamaha” (*****: model name of the unit).**

After pairing has been completed and the unit is connected to the Bluetooth device, “Connected” appears on the front display. While a Bluetooth connection is established, the Bluetooth indicators light up.



Note

- If you are prompted to input a passkey during a pairing procedure, input the numerals “0000”.
- Complete a pairing procedure within 30 seconds.
- If no Bluetooth devices are found, “Not found” appears on the front display.

Connecting a previously-connected Bluetooth® device

Connects a previously-connected Bluetooth device (such as a smartphone) for playing back music files on the unit that are stored on the device.

Option menu

“Connect”

- 1 Press BLUETOOTH to select “Bluetooth” as the input source.**
- 2 Press OPTION.**
- 3 Use the cursor keys to select “Connect” and press ENTER.**

“Searching...” appears on the front display. After pairing has been completed and the unit is connected to the previously-connected Bluetooth device, “Connected” appears on the front display. While a Bluetooth connection is established, the Bluetooth indicators light up.

Disconnecting the connection with a Bluetooth® device

Disconnects the Bluetooth connection between the unit and a Bluetooth device (such as a smartphone) when playing back music files on the unit that are stored on the Bluetooth device.

Option menu

“Disconnect”

- 1 Press OPTION during the Bluetooth connection.**
- 2 Use the cursor keys to select “Disconnect” and press ENTER.**

This completes the disconnection.

Enabling automatic switching of the input source when Bluetooth® connects

Sets whether the input source automatically switches to “Bluetooth” when a Bluetooth connection is established.

Option menu

“Input Interlock”

Settings

Off	The input source is not automatically switched even if a Bluetooth connection is established.
On	Automatically switches the input source to “Bluetooth” when a Bluetooth connection is established.

CONFIGURATIONS

Configuring various functions (Setup menu)

Basic operation of the Setup menu

Perform the following basic procedure to operate the “Setup” menu. You can configure the unit’s various functions with the “Setup” menu.

1 Press SETUP.

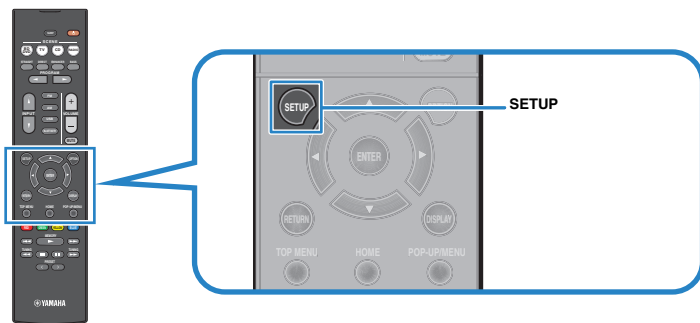

2 Use the cursor keys to select a menu and press ENTER.

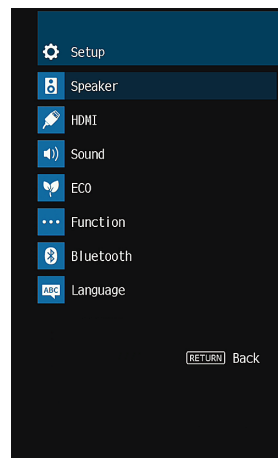

3 Use the cursor keys to select an item and press ENTER.

4 Use the cursor keys to select a setting and press ENTER.

5 Press SETUP.

This completes the settings.

Note

For details on the default settings, see the following:

- “Default settings of the Setup menu” (p.110)

Setup menu items

Use the following table to configure various functions of the unit.

Menu	Item	Function	Page	
Speaker	Configuration	Power Amp Assign	Selects a speaker system.	p.67
		Subwoofer	Selects whether or not a subwoofer is connected.	p.67
		Front	Selects the size of the front speakers.	p.67
		Center	Selects whether or not a center speaker is connected and its size.	p.68
		Surround	Selects whether or not surround speakers are connected and their size.	p.68
		Crossover	Sets the lower limit of the low-frequency component that can be output from speakers whose size is set to "Small".	p.69
		Subwoofer Phase	Sets the phase of the subwoofer.	p.69
		Extra Bass	Enables/disables Extra Bass.	p.69
	Virtual CINEMA FRONT	Enables/disables the front 5-channel speaker (Virtual CINEMA FRONT) configuration.	p.70	
	Distance	Sets the distance between each speaker and the listening position.	p.70	
	Level	Adjusts the volume of each speaker.	p.70	
	Equalizer	Adjusts the tone with an equalizer.	p.71	
	Test Tone	Enables/disables the test tone output.	p.71	
	HDMI	HDMI Control	Enables/disables HDMI Control.	p.72
Audio Output		Enables/disables audio output from a TV.	p.72	
Standby Through		Selects whether to output video/audio (input through HDMI jacks) to the TV when the unit is in standby mode.	p.72	
4K Upscaling		Enables/disables the upscaling function.	p.72	
HDCP Version		Selects the version of HDCP used on the HDMI input jacks.	p.73	
TV Audio Input		Selects an audio input jack of the unit to be used for TV audio input.	p.73	
Standby Sync		Selects whether to use HDMI control to link the standby behavior of the TV and the unit.	p.73	
ARC		Enables/disables ARC.	p.73	
SCENE		Enables/disables SCENE link playback.	p.74	

Menu	Item	Function	Page	
Sound	DSP Parameter	Panorama	Enables/disables the broadening effect of the front sound field.	p.75
		Center Width	Adjusts the broadening effect of the center sound field.	p.75
		Dimension	Adjusts the difference in level between the front and surround sound fields.	p.75
		Center Image	Adjusts the center localization (broadening effect) of the front sound field.	p.75
		Monaural Mix	Enables/disables monaural sound output.	p.76
	Lipsync	Select	Selects the method to adjust the delay between video and audio output.	p.76
		Adjustment	Adjusts the delay between video and audio output manually.	p.76
	Dialogue	Dialogue Level	Adjusts the volume of dialogue sounds.	p.76
	Volume	Scale	Switches the scale of the volume display.	p.77
		Dynamic Range	Selects the dynamic range adjustment method for bitstream audio (Dolby Digital and DTS signals) playback.	p.77
		Max Volume	Sets the limit value of the volume.	p.77
ECO	Initial Volume	Sets the initial volume for when this receiver is turned on.	p.77	
	Auto Power Standby	Set the amount of time for the auto-standby function.	p.78	
Function	ECO Mode	Enables/disables the eco mode (power saving mode).	p.78	
	Input Rename	Changes the input source name displayed on the front display.	p.79	
	Input Skip	Set which input sources are skipped when operating the INPUT key.	p.80	
	Dimmer	Adjusts the brightness of the front display.	p.80	
	Memory Guard	Prevents accidental changes to the settings.	p.80	
	Remote Color Key	Set the unit's functions for the RED/GREEN/YELLOW/BLUE keys of the remote control.	p.81	
Bluetooth	Bluetooth	Enables/disables the Bluetooth functions.	p.82	
	Audio Receive	Disconnect	Terminates the Bluetooth connection between the Bluetooth device (such as smartphones) and the unit.	p.82
		Bluetooth Standby	Selects whether to enable/disable the function that turns on the unit from Bluetooth devices (Bluetooth standby).	p.82
	Audio Send	Transmitter	Enables/disables the Bluetooth audio transmitter function.	p.83
		Device Search	Searches available Bluetooth devices (speakers/headphones) when the unit is used as a Bluetooth audio transmitter.	p.83
Language		Select an on-screen menu language.	p.84	

Configuring the speaker settings

Setting your speaker system

Select the setting according to the speakers that are connected.

Setup menu

"Speaker" > "Configuration" > "Power Amp Assign"

Settings

Surround	Select this option when you use a normal speaker system (not using a bi-amp connections).
BI-AMP	Select this option when you connect front speakers that support bi-amp connections.

Note

For details on the speaker system, see the following:

- "Speaker systems and speakers to be connected" (p.14)
- "Connecting front speakers that support bi-amp connections" (p.20)

Setting the use of a subwoofer

Selects the setting according to the use of your subwoofer.

Setup menu

"Speaker" > "Configuration" > "Subwoofer"

Settings

	Select this option when a subwoofer is connected.
Use	The subwoofer will produce LFE (low-frequency effect) channel audio and low-frequency components from other channels.
	Select this option when no subwoofer is connected.
None	The front speakers will produce LFE (low-frequency effect) channel audio and low-frequency components from other channels.

Setting the size of the front speakers

Selects the setting according to the size of your front speakers.

Setup menu

"Speaker" > "Configuration" > "Front"

Settings

	Select this option for small speakers.
Small	The subwoofer will produce front channel low-frequency components (configurable in "Crossover").
	Select this option for large speakers.
Large	The front speakers will produce all of the front channel frequency components.

Note

- When configuring the speaker size, as a general guideline, select "Large" if the woofer diameter of your speaker is 16 cm (6-1/4") or larger, or "Small" if it is smaller than 16 cm (6-1/4").
- "Front" is automatically set to "Large" when "Subwoofer" is set to "None". For details on "Subwoofer" in the "Setup" menu, see the following:
 - "Setting the use of a subwoofer" (p.67)

Setting the use of a center speaker and its size

Selects the setting according to the use and size of your center speaker.

Setup menu

"Speaker" > "Configuration" > "Center"

Settings

	Select this option for small speakers.
Small	The subwoofer or front speakers will produce center channel low-frequency components (configurable in "Crossover").
	Select this option for large speakers.
Large	The center speaker will produce all of the center channel frequency components.
	Select this option when no center speaker is connected.
None	The front speakers will produce center channel audio.

Note

When configuring the speaker size, as a general guideline, select "Large" if the woofer diameter of your speaker is 16 cm (6.1/4") or larger, or "Small" if it is smaller than 16 cm (6.1/4").

Setting the use of surround speakers and their size

Selects the setting according to the use and size of your surround speakers.

Setup menu

"Speaker" > "Configuration" > "Surround"

Settings

	Select this option for small speakers.
Small	The subwoofer or front speakers will produce surround channel low-frequency components (configurable in "Crossover").
	Select this option for large speakers.
Large	The surround speakers will produce all of the surround channel frequency components.
	Select this option when no surround speakers are connected.
None	The front speakers will produce surround channel audio. Virtual CINEMA DSP works in this case.

Note

- When configuring the speaker size, as a general guideline, select "Large" if the woofer diameter of your speaker is 16 cm (6.1/4") or larger, or "Small" if it is smaller than 16 cm (6.1/4").
- For details on Virtual CINEMA DSP, see the following:
 - "Enjoying sound field effects without surround speakers (Virtual CINEMA DSP)" (p.32)

Setting the crossover frequency of the low-frequency components

Sets the lower limit of the low-frequency components that can be output from a speaker whose size is set to "Small". A frequency sound lower than the specified value will be produced from the subwoofer or front speakers.

Setup menu

"Speaker" > "Configuration" > "Crossover"

Settings

40 Hz, 60 Hz, 80 Hz, 90 Hz, 100 Hz, 110 Hz, 120 Hz, 160 Hz, 200 Hz

Note

If the volume and crossover frequency are adjustable on your subwoofer, set the volume to half and crossover frequency to maximum.

Setting the phase of the subwoofer

Sets the phase of the subwoofer. When the bass sound is lacking or unclear, switch the subwoofer phase.

Setup menu

"Speaker" > "Configuration" > "Subwoofer Phase"

Settings

Normal	Does not reverse the subwoofer phase.
Reverse	Reverses the subwoofer phase.

Note

This setting is not available when "Subwoofer" is set to "None". For details on "Subwoofer" in the "Setup" menu, see the following:

- "Setting the use of a subwoofer" (p.67)

Setting the use of Extra Bass

Enables/disables Extra Bass. When Extra Bass is enabled, you can enjoy enhanced bass sounds, regardless of the size of the front speakers and the presence or absence of the subwoofer.

Setup menu

"Speaker" > "Configuration" > "Extra Bass"

Settings

Off	Disables Extra Bass.
On	Enables Extra Bass.

Note

You can also use BASS on the remote control to enable/disable Extra Bass.

Setting the use of Virtual CINEMA FRONT

Selects whether to use Virtual CINEMA FRONT.

Note

Select “On” only when utilizing the Virtual CINEMA FRONT configuration. For details, see the following:

- “Using Virtual CINEMA FRONT” (p.19)

Setup menu

“Speaker” > “Configuration” > “Virtual CINEMA FRONT”

Settings

Off	Disables Virtual CINEMA FRONT
On	Enables Virtual CINEMA FRONT

Note

This setting is not available when “Surround” is set to “None”. For details on “Surround” in the “Setup” menu, see the following:

- “Setting the use of surround speakers and their size” (p.68)

Setting the distance between each speaker and the listening position

Sets the distance between each speaker and the listening position so that sounds from the speakers reach the listening position at the same time.

Setup menu

“Speaker” > “Distance”

Choices

Front L, Front R, Center, Surround L, Surround R, Subwoofer

Setting range

0.30 m to 24.00 m (1.0 ft to 80.0 ft), 0.05 m (0.2 ft) increments

Note

Select the unit of distance from “Meter” or “Feet” in “Unit”.

Adjusting the volume of each speaker

Adjusts the volume of each speaker to suit your listening position.

Setup menu

“Speaker” > “Level”

Choices

Front L, Front R, Center, Surround L, Surround R, Subwoofer

Setting range

-10.0 dB to +10.0 dB (0.5 dB increments)

Note

Test tone output helps you to adjust the speaker balance while confirming its effect. For details, see the following:

- “Outputting test tones” (p.71)

Setting the equalizer

Selects the type of equalizer to be used and adjusts the tone.

Setup menu

“Speaker” > “Equalizer” > “EQ Select”

Settings

PEQ	Applies the parametric equalizer values obtained by the YPAO measurement.
GEQ	Select this option when you want to adjust the equalizer manually.
Off	Does not use the equalizer.

When selecting “GEQ”

1 Use the cursor keys to select “Channel” and to select the desired speaker channel.

2 Use the cursor keys to select the desired band (frequency) and to adjust the gain.

Setting range

-6.0 dB to +6.0 dB

3 Press SETUP.

This completes the settings.

Note

- Test tone output helps you to adjust the equalizer while confirming its effect. For details, see the following:
 - “Outputting test tones” (p.71)
- “PEQ” is available only when the YPAO has been performed. For details on the YPAO, see the following:
 - “Optimizing the speaker settings automatically (YPAO)” (p.27)

Outputting test tones

Enables/disables the test tone output. Test tone output helps you to adjust the speaker balance or equalizer while confirming its effect.

Setup menu

“Speaker” > “Test Tone”

Settings

Off	Does not output test tones.
On	Outputs test tones automatically when you adjust the speaker balance or equalizer.

Configuring the HDMI settings

Setting the use of HDMI Control

Enables/disables HDMI Control. HDMI Control allows you to operate external devices via HDMI.

Setup menu

"HDMI" > "HDMI Control"

Settings

Off	Disables HDMI Control.
On	Enables HDMI Control. Configure the settings in "TV Audio Input", "Standby Sync", "ARC", and "SCENE".

Note

To use HDMI control, you need to perform the HDMI Control link setup after connecting HDMI Control-compatible devices. For details, see the following:

- "HDMI Control and synchronized operations" (p.102)

Setting the output of HDMI audio from the TV speaker

Enables/disables audio output from a TV connected to the HDMI OUT jack when "HDMI Control" is set to "Off".

Note

For details on "HDMI Control" in the "Setup" menu, see the following:

- "Setting the use of HDMI Control" (p.72)

Setup menu

"HDMI" > "Audio Output"

Settings

Off	Disables audio output from the TV.
On	Enables audio output from the TV.

Setting the use of HDMI Standby Through

Select whether to output video/audio (input through HDMI jacks) to the TV when the unit is in standby mode.

Note

If this function is set to "On" or "Auto", you can use the input selection keys (HDMI 1–4) to select an HDMI input even when the unit is in standby mode (the standby indicator on the unit blinks).

Setup menu

"HDMI" > "Standby Through"

Settings

Off	Does not output video/audio to the TV.
Auto	Automatically selects whether to output video/audio depending on the status of the connected device.
On	Outputs video/audio to the TV. (The unit consumes more power than when "Off" or "Auto" is selected.)

Note

- "Off" is not selectable when "HDMI Control" is set to "On".
- For details on "HDMI Control" in the "Setup" menu, see the following:
 - "Setting the use of HDMI Control" (p.72)

Setting the use of 4K upscaling of the HDMI video signal

Enables/disables the upscaling function. When it is enabled, 1080p content is displayed at 4K resolution.

Setup menu

"HDMI" > "4K Upscaling"

Settings

Off	Disables the upscaling function.
On	Enables the upscaling function.

Setting the version of HDCP used on the HDMI input jacks

Selects the HDCP version of the HDMI input jacks for watching 4K video content.

Setup menu

"HDMI" > "HDCP Version"

Input sources

HDMI 1-4

Settings

Auto	Automatically sets the version of HDCP according to content.
1.4	Sets the version of HDCP to always be 1.4.

Setting the audio jack used for TV audio input

Selects an audio input jack of the unit to be used for TV audio input when "HDMI Control" is set to "On". The unit's input source automatically switches to TV audio when the TV input is switched to its built-in tuner.

Note

For details on "HDMI Control" in the "Setup" menu, see the following:

- "Setting the use of HDMI Control" (p.72)

Setup menu

"HDMI" > "TV Audio Input"

Settings

AV 1-3, AUDIO 1-2

Note

When using ARC to input TV audio to the unit, the input jacks selected here will be used for TV Audio Input.

Linking the standby modes of the unit and the TV

Select whether to use HDMI control to link the unit's standby mode to the TV's power when "HDMI Control" is set to "On".

Note

For details on "HDMI Control" in the "Setup" menu, see the following:

- "Setting the use of HDMI Control" (p.72)

Setup menu

"HDMI" > "Standby Sync"

Settings

Off	Does not set the unit to standby mode when the TV is turned off.
On	Sets the unit to standby mode when the TV is turned off.
Auto	Sets the unit to standby mode when the TV is turned off only when the unit is receiving TV audio or HDMI signals.

Setting the use of ARC

Select whether to output TV audio to the speakers connected to the unit when "HDMI Control" is set to "On".

Note

For details on "HDMI Control" in the "Setup" menu, see the following:

- "Setting the use of HDMI Control" (p.72)

Setup menu

"HDMI" > "ARC"

Settings

Off	Disables ARC.
On	Enables ARC.

Note

You do not need to change this setting normally. In case noises are produced from the speakers connected to the unit because TV audio signals input to the unit via ARC are not supported by the unit, set "ARC" to "Off" and use the TV's speakers.

Setting the use of SCENE link playback

Enables/disables SCENE link playback when "HDMI Control" is set to "On".

When SCENE link playback is enabled, HDMI Control-compatible devices connected to the unit via HDMI automatically work as follows when a scene is selected.

- TV: turning on and displaying video from the playback device
- Playback device: starting playback

Note

For details on "HDMI Control" in the "Setup" menu, see the following:

- "Setting the use of HDMI Control" (p.72)

Setup menu

"HDMI" > "SCENE"

Choices (SCENE keys)

BD / DVD, TV, CD, RADIO

Settings

Off	Disables SCENE link playback for the selected SCENE key.
On	Enables SCENE link playback for the selected SCENE key.

Note

SCENE link playback may not work properly due to the compatibility between devices. We recommend using TV and playback devices from the same manufacturer so that HDMI Control works more effectively.

Configuring the sound settings

Setting the broadening effect of the front sound field

Enables/disables the broadening effect of the front sound field. When this function is enabled, you can wrap front left/right channel sounds around the sound field and generate a spacious sound field in combination with the surround sound field. This setting is effective when "DPL Music" is selected.

Setup menu

"Sound" > "DSP Parameter" > "Panorama"

Settings

Off	Disables the broadening effect of the front sound field.
On	Enables the broadening effect of the front sound field.

Note

For details on the surround decoder, see the following:

- "Selecting the surround decoder used in the program" (p.55)

Adjusting the broadening effect of the center sound field

Adjusts the broadening effect of the center sound field. Higher to enhance the broadening effect, and lower to reduce it (closer to center). This setting is effective when "DPL Music" is selected.

Setup menu

"Sound" > "DSP Parameter" > "Center Width"

Setting range

0 to 7

Note

For details on the surround decoder, see the following:

- "Selecting the surround decoder used in the program" (p.55)

Adjusting the difference in level between the front and surround sound fields

Adjusts the difference in level between the front and surround sound fields. Higher to strengthen the front sound field and lower to strengthen the surround sound field. This setting is effective when "DPL Music" is selected.

Setup menu

"Sound" > "DSP Parameter" > "Dimension"

Setting range

-3 to +3

Note

For details on the surround decoder, see the following:

- "Selecting the surround decoder used in the program" (p.55)

Adjusting the center localization (broadening effect) of the front sound field

Adjusts the center localization (broadening effect) of the front sound field. Adjust this higher to strengthen the center localization (less broadening effect) or lower to weaken it (more broadening effect). This setting is effective when "Neo:6 Music" is selected.

Setup menu

"Sound" > "DSP Parameter" > "Center Image"

Setting range

0.0 to 1.0

Note

For details on the surround decoder, see the following:

- "Selecting the surround decoder used in the program" (p.55)

Setting the use of Monaural Mix

Enables/disables monaural sound output. This function can be applicable when the sound program is set to "5ch Stereo" only.

Setup menu

"Sound" > "DSP Parameter" > "Monaural Mix"

Settings

Off	Disables monaural sound output.
On	Enables monaural sound output.

Setting the adjustment method of the Lipsync function

Selects the method for adjusting the delay between video and audio output.

Setup menu

"Sound" > "Lipsync" > "Select"

Settings

Manual	Select this option when you want to adjust the delay between video and audio output manually. Adjust the audio output timing in "Adjustment".
Auto	Adjusts the delay between video and audio output automatically when a TV that supports an automatic lipsync function is connected to the unit via HDMI. If necessary, you can fine-adjust the audio output timing in "Adjustment".

Note

- You can enable/disable the Lipsync function by input sources in "Lipsync" in the "Option" menu. For details, see the following:
 - "Enabling Lipsync adjustment" (p.57)
- For details on "Adjustment" in the "Setup" menu, see the following:
 - "Adjusting the delay of the Lipsync function" (p.76)

Adjusting the delay of the Lipsync function

Adjusts the delay between video and audio output manually when "Select" is set to "Manual". You can fine-adjust the audio output timing when "Select" is set to "Auto".

Setup menu

"Sound" > "Lipsync" > "Adjustment"

Setting range

0 ms to 500 ms (1 ms increments)

Note

For details on "Select" in the "Setup" menu, see the following:

- "Setting the adjustment method of the Lipsync function" (p.76)

Adjusting the volume of dialogue sound

Adjusts the volume of dialogue sounds that are hardly heard.

Setup menu

"Sound" > "Dialogue" > "Dialogue Level"

Setting range

0 to 3 (higher to strengthen)

Setting the scale of the volume display

Switches the scale of the volume display.

Setup menu

“Sound” > “Volume” > “Scale”

Settings

dB	Displays the volume in the “dB” unit.
0-97	Displays the volume in the numeric value (0.5 to 97.0).

Setting the dynamic range adjustment method

Selects the dynamic range adjustment method for bitstream audio (Dolby Digital and DTS signals) playback.

Setup menu

“Sound” > “Volume” > “Dynamic Range”

Settings

Maximum	Produces audio without adjusting the dynamic range.
Standard	Optimizes the dynamic range for regular home use.
Min/Auto	Sets the dynamic range for clear sound even at night or at low volumes. When playing back Dolby TrueHD signals, the dynamic range is automatically adjusted based on the input signal information.

Setting the limit value of the volume

Sets the limit value of the volume adjusted by using such as VOLUME keys on the remote control.

Setup menu

“Sound” > “Volume” > “Max Volume”

Setting range

-60.0 dB to +15.0 dB (5.0 dB increments), +16.5 dB [20.0 to 95.0 (5.0 increments), 97.0]

Setting the initial volume for when the unit is turned on

Sets the initial volume when the unit is turned on.

Setup menu

“Sound” > “Volume” > “Initial Volume”

Settings

Off	Sets the level to the volume level of the unit when it last entered standby mode.
Mute	Sets the unit to mute the audio output.
-80.0 dB to +16.5 dB (0.5 dB increments) [0.5 to 97.0 (0.5 increments)]	Sets the level to the specified volume level.

Note

This setting works only when the volume level is set lower than “Max Volume”. For details on “Max Volume” in the “Setup” menu, see the following:

- “Setting the limit value of the volume” (p.77)

Configuring the power supply settings

Setting the amount of time for the auto-standby function

Set the amount of time for the auto-standby function.

Setup menu

"ECO" > "Auto Power Standby"

Settings

Off	Does not set the unit to standby mode automatically.
5 minutes, 20 minutes	Sets the unit to standby mode when you have not operated the unit and the unit has not detected any input signal for the specified time.
2 hours, 4 hours, 8 hours, 12 hours	Sets the unit to standby mode when you have not operated the unit for the specified time.

Note

Just before the unit enters standby mode, "AutoPowerStdby" appears and then countdown starts in the front display.

Setting the use of the eco mode

You can reduce the unit's power consumption by setting the eco mode to "On". After changing the setting, be sure to press ENTER to restart the unit.

When the eco mode is enabled, you can reduce the unit's power consumption.

Setup menu

"ECO" > "ECO Mode"

Settings

Off	Disables the eco mode.
On	Enables the eco mode.

Note

- When "ECO Mode" is set to "On", the front display may become dark.
- If you want to play audio at high volume, set "ECO Mode" to "Off".

Configuring the function settings

Automatically changing the input source names displayed on the front display

Automatically changes the input source names displayed on the front display. You can select a name created by the Auto Rename function.

Setup menu

"Function" > "Input Rename"

Input sources

HDMI 1-4, AV 1-3, AUDIO 1-2

- 1 Use the cursor keys to select an input source to be renamed.**
- 2 Use the cursor keys to select "Auto".**
- 3 To change another input source name, repeat steps 1 to 2.**
- 4 Press SETUP.**

This completes the settings.

Note

When "Auto" is selected, the created name is saved even after the external device is disconnected. To reset to the default setting, switch the setting to "Manual" and then back to "Auto".

Manually changing the input source names displayed on the front display

Allows the input source names displayed on the front display to be set manually.

Setup menu

"Function" > "Input Rename"

Input sources

HDMI 1-4, AV 1-3, AUX, AUDIO 1-2, TUNER, USB

- 1 Use the cursor keys to select an input source to be renamed.**
- 2 Use the cursor keys to select "Manual" and press ENTER.**
The edit screen is displayed.
- 3 Use the cursor keys and ENTER key to edit the name, and then select "OK" and press ENTER.**

Note

- To cancel the entry, select "CANCEL".
- If you select "RESET", the default input name will be inserted into the editing area.

- 4 To change another input source name, repeat steps 1 to 3.**
- 5 Press SETUP.**

This completes the settings.

Setting input sources to be skipped when operating the INPUT key

Set which input sources are skipped when operating the INPUT key.

You can select the desired input source quickly by using this function.

Setup menu

"Function" > "Input Skip"

Input sources

HDMI 1-4, AV 1-3, AUX, AUDIO 1-2, TUNER, Bluetooth, USB

Settings

Off	Does not skip the selected input source.
On	Skips the selected input source.

Adjusting the brightness of the front display

Adjusts the brightness of the front display.

Setup menu

"Function" > "Dimmer"

Setting range

-4 to 0 (higher to brighten)

Note

The front display may become dark when "ECO Mode" is set to "On". For details, see the following:

- "Setting the use of the eco mode" (p.78)

Preventing accidental changes to the settings

Prevents accidental changes to the settings.

Setup menu

"Function" > "Memory Guard"

Settings

Off	Does not protect the settings.
On	Protects the settings until "Off" is selected.

Note

When "Memory Guard" is set to "On", the lock icon (🔒) is displayed on the menu screen.

Setting the unit's functions for the RED/GREEN/YELLOW/BLUE keys of the remote control

Set the unit's functions for the RED/GREEN/YELLOW/BLUE keys of the remote control.

Setup menu

"Function" > "Remote Color Key"

Settings

Default	<p>Assigns the functions of devices connected to the unit with an HDMI cable.</p> <p>This setting is effective when "HDMI Control" is set to "On".</p>
Input	<p>Assigns the unit's input sources to each key. The assigned input sources can be set separately.</p> <p>Input sources</p> <p>HDMI 1-4, AV 1-3, AUX, AUDIO 1-2, TUNER, Bluetooth, USB</p> <p>Default</p> <p>RED: HDMI2, GREEN: HDMI4, YELLOW: AV 2, BLUE: AUX</p>
Program	<p>Assigns the functions of sound mode to each key.</p> <p>RED: MOVIE</p> <p>GREEN: MUSIC</p> <p>YELLOW: STEREO</p> <p>BLUE: SUR.DECODE</p>
TV Control	<p>Assigns the functions of TV Control to each key.</p> <p>RED: EXIT (closes the menu on the TV)</p> <p>GREEN: INFO (displays information about the TV such as the resolution)</p> <p>YELLOW: BROADCAST (switches the TV broadcast type)</p> <p>BLUE: INPUT (switches the TV input)</p> <p>This setting is effective when "HDMI Control" is set to "On".</p>

Note

- For details on "HDMI Control" in the "Setup" menu, see the following:
 - "Setting the use of HDMI Control" (p.72)
- To use HDMI control, you need to perform the HDMI Control link setup after connecting HDMI Control-compatible devices. For details, see the following:
 - "HDMI Control and synchronized operations" (p.102)
- HDMI Control might not work properly.

Configuring the Bluetooth® settings

Setting the use of Bluetooth®

Enables/disables the Bluetooth function.

Setup menu

"Bluetooth" > "Bluetooth"

Settings

Off	Disables the Bluetooth function.
On	Enables the Bluetooth function.

Terminating the connection between a Bluetooth® device and the unit

Terminates the Bluetooth connection between a Bluetooth device (such as a smartphone) and the unit.

Setup menu

"Bluetooth" > "Audio Receive" > "Disconnect"

Select "Disconnect" and press ENTER to terminate the Bluetooth connection.

Note

This setting is not available when no Bluetooth devices are connected.

Setting the use of the Bluetooth® Standby function

Selects whether to enable/disable the function that turns on the unit from Bluetooth devices (Bluetooth standby). If this function is set to "On", the unit automatically turns on when a connect operation is performed on the Bluetooth device.

Setup menu

"Bluetooth" > "Audio Receive" > "Bluetooth Standby"

Settings

Off	Disables the Bluetooth standby function.
On	Enables the Bluetooth standby function. (The unit consumes more power than when "Off" is selected.)

Setting the use of audio transmission to a Bluetooth® device

Enables/disables the Bluetooth audio transmitter function.

When this function is enabled, you can enjoy audio played back on the unit using Bluetooth speakers/headphones.

Setup menu

"Bluetooth" > "Audio Send" > "Transmitter"

Settings

Off	Disables the Bluetooth audio transmitter function.
On	Enables the Bluetooth audio transmitter function.

Note

For details on connecting Bluetooth devices to which audio is transmitted (speakers, headphones, etc.), see the following:

- "Connecting the unit to a Bluetooth® device that receives transmitted audio" (p.83)

Connecting the unit to a Bluetooth® device that receives transmitted audio

Establishes a connection between the unit and Bluetooth devices that receive audio transmitted from the unit, such as speakers and headphones, when "Transmitter" is set to "On" in the "Setup" menu.

Note

For details on "Transmitter" in the "Setup" menu, see the following:

- "Setting the use of audio transmission to a Bluetooth® device" (p.83)

Setup menu

"Bluetooth" > "Audio Send" > "Device Search"

1 Press ENTER.

A list of Bluetooth devices that can connect to the unit is displayed.

2 Use the cursor keys to select the Bluetooth speakers/headphones to be connected with the unit and press ENTER.

When the connection process finishes, "Completed" appears.

3 Press ENTER.

This completes the settings.

Note

- If the desired Bluetooth device is not displayed on the list, set the Bluetooth device to pairing mode and then perform "Device Search" operation again.
- To terminate the Bluetooth connection, perform a disconnect operation on the Bluetooth speakers/headphones.

Configuring the language settings

Setting the on-screen menu language

Select the on-screen menu language.

Setup menu

"Language"

Settings

English	English
日本語	Japanese
Français	French
Deutsch	German
Español	Spanish
Русский	Russian
Italiano	Italian
中文	Chinese

Note

The information on the front display is provided in English only.

Configuring the advanced settings (ADVANCED SETUP menu)

Basic operation of the ADVANCED SETUP menu

Perform the following basic procedure to operate the “ADVANCED SETUP” menu while viewing the front display.

- 1 Set the unit to standby mode.
- 2 While holding down STRAIGHT on the front panel, press  (power).

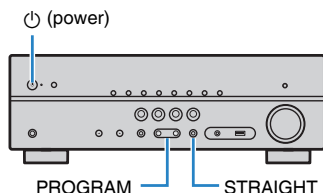

The top item and its setting of the “ADVANCED SETUP” menu appear on the front display.

- 3 Press PROGRAM to select an item.
- 4 Press STRAIGHT to select a setting.
- 5 Press  (power) to set the unit to standby mode and turn it on again.

This completes the settings.

Note

For details on the default settings, see the following:

- “Default settings of the ADVANCED SETUP menu” (p.111)

ADVANCED SETUP menu items

Use the following table to configure system settings of the unit.

Item	Function	Page
SP IMP.	(U.S.A. and Canada models only) Changes the speaker impedance setting.	p.85
REMOTE ID	Selects the unit's remote control ID.	p.86
TU	(Asia, Taiwan, Brazil and Central and South America models only) Changes the FM/AM tuning frequency setting.	p.86
TV FORMAT	Switches the video signal type of HDMI output.	p.87
4K MODE	Selects the HDMI 4K signal format.	p.87
INIT	Restores the default settings.	p.88
UPDATE	Updates the firmware.	p.88
VERSION	Checks the version of firmware currently installed on the unit.	p.88

Changing the speaker impedance setting (SP IMP.)

(U.S.A. and Canada models only)



Change the unit's speaker impedance settings depending on the impedance of the speakers connected.

ADVANCED SETUP menu

“SP IMP.”

Settings

6 Ω MIN	Select this option when you connect 6-ohm speakers to the unit.
8 Ω MIN	Select this option when you connect 8-ohm or higher speakers to the unit.

Selecting the remote control ID (REMOTE ID)



REMOTE ID •• ID1

Change the unit's remote control ID so that it matches the remote control's ID (default: ID1). When using multiple Yamaha AV receivers, you can set each remote control with a unique remote control ID for its corresponding receiver.

ADVANCED SETUP menu

"REMOTE ID"

Settings

ID1, ID2

Changing the remote control ID of the remote control

- To select ID1, while holding down the left cursor key, hold down SCENE (BD/DVD) for 5 seconds.
- To select ID2, while holding down the left cursor key, hold down SCENE (TV) for 5 seconds.

Changing the FM/AM tuning frequency setting (TU)

(Asia, Taiwan, Brazil and Central and South America models only)



TU •••• FM50/AM9

Change the FM/AM tuning frequency setting of the unit depending on your country or region.

ADVANCED SETUP menu

"TU"

Settings

FM100/AM10	Select this when you want to adjust the FM frequency by 100-kHz steps and AM by 10-kHz steps.
FM50/AM9	Select this when you want to adjust the FM frequency by 50-kHz steps and AM by 9-kHz steps.

Switching the video signal type (TV FORMAT)

TV FORMAT • NTSC

Switch the video signal type of HDMI output so that it matches to the format of your TV. Since the unit automatically selects the video signal type so that it matches to the TV, it is unnecessary to change the setting normally. Change the setting only when images on the TV screen do not appear correctly.

ADVANCED SETUP menu

“TV FORMAT”

Settings

NTSC, PAL

Selecting the HDMI 4K signal format (4K MODE)

4K MODE • MODE 1

Selects the format of signals input/output at the unit when HDMI 4K compatible TV and playback device are connected to the unit.

ADVANCED SETUP menu

“4K MODE”

Settings

MODE 1	Inputs/outputs 4K signals shown in the following table. Depending on the connected device or HDMI cables, video may not be displayed correctly. In this case, select “MODE 2”.
MODE 2	Inputs/outputs 4K signals shown in the following table.

Note

When “MODE 1” is selected, use a Premium High Speed HDMI Cable or Premium High Speed Cable with Ethernet.

Format

		MODE 1			MODE 2		
		8 bit	10 bit	12 bit	8 bit	10 bit	12 bit
4K/60, 50 Hz	RGB 4:4:4	✓	–	–	–	–	–
	YCbCr 4:4:4	✓	–	–	–	–	–
	YCbCr 4:2:2	–	✓	–	–	–	–
	YCbCr 4:2:0	–	✓	–	✓	–	–
4K/30, 25, 24 Hz	RGB 4:4:4	–	✓	–	✓	–	–
	YCbCr 4:4:4	–	✓	–	✓	–	–
	YCbCr 4:2:2	–	✓	–	–	✓	–

Restoring the default settings (INIT)



INIT * * * * CANCEL

Restores the default settings for the unit.

ADVANCED SETUP menu

"INIT"

Choices

ALL	Restores the default settings for the unit.
CANCEL	Does not perform an initialization.

Updating the firmware (UPDATE)



UPDATE * * * * * USB

New firmware that provides additional features or product improvements will be released as needed. Updates can be downloaded from our website to a USB memory device. You can update the firmware using this USB memory device. For details, refer to the information supplied with updates.

ADVANCED SETUP menu

"UPDATE"

Note

Do not perform this menu unless firmware update is necessary. Also, make sure you read the information supplied with updates before updating the firmware.

Checking the firmware version (VERSION)



VERSION * * XX.XX

Check the version of firmware currently installed on the unit.

ADVANCED SETUP menu

"VERSION"

TROUBLESHOOTING

When any problem appears

If trouble occurs, first check the following:

Make sure of the following when the unit does not function properly.

- The power cables of the unit, TV and playback devices (such as BD/DVD players) are connected to AC wall outlets securely.
- The unit, subwoofer, TV and playback devices (such as BD/DVD players) are turned on.
- The connectors of each cable are securely inserted in to jacks on each device.

If there is no problem with the power and cables, refer to the instructions shown in "When any problem appears" corresponding to the trouble of the unit.

If the problem you are experiencing is not listed or if the instructions do not help, turn off the unit, disconnect the power cable, and contact the nearest authorized Yamaha dealer or service center.

Power, system, or remote control trouble

■ The power does not turn on

- **The protection circuitry has been activated three times consecutively.**
If the standby indicator on the unit blinks when you try to turn on the power, as a safety precaution, capability to turn on the power is disabled. Contact your nearest Yamaha dealer or service center to request repair.

■ The power does not turn on in synchronization with the TV

- **HDMI Control on the unit is disabled.**
If turning off the unit is not synchronized to the TV either, check the setting of HDMI Control on the unit. For details on HDMI Control, see the following:
 - "Setting the use of HDMI Control" (p.72)
- **HDMI Control on the TV is disabled.**
If only turning on the unit is not synchronized to the TV, check the setting on the TV. For details, refer to the instruction manual for the TV and set HDMI Control on the TV.
- **Because of a power failure, the unit's power is no longer synchronized.**
Disconnect the HDMI cables and power cables, and after five minutes, reconnect the cables of playback devices first, then the unit, and then the TV. Then, check that the power is synchronized.

■ The power does not turn off

- **The internal microcomputer has frozen, due to an external electric shock (such as lightning or excessive static electricity) or to a drop in the power supply voltage.**
Hold down ⏻ (power) on the front panel for more than 15 seconds to reboot the unit. If the problem persists, disconnect the power cable from the AC wall outlet and plug it again.

■ The power turns off (standby mode) immediately

- **The unit was turned on while a speaker cable was shorted.**

Twist the bare wires of each speaker cable firmly and reconnect to the unit and speakers. For details, see the following:

- “Connecting the speaker” (p.15)

■ The unit enters standby mode automatically

- **The sleep timer worked.**

Turn on the unit and start playback again.

- **The auto-standby function activated because the unit was not used for the specified time.**

To disable the auto-standby function, set “Auto Power Standby” in the “Setup” menu to “Off”. For details, see the following:

- “Setting the amount of time for the auto-standby function” (p.78)

- **The speaker impedance setting is incorrect.**

Set the speaker impedance to match your speakers. For details, see the following:

- “Changing the speaker impedance setting (SP IMP.)” (p.85)

- **The protection circuitry has been activated because of a short circuit.**

Twist the bare wires of each speaker cable firmly and reconnect to the unit and speakers. For details, see the following:

- “Connecting the speaker” (p.15)

■ The unit is not reacting

- **The internal microcomputer is frozen, due to an external electric shock (such as lightning or excessive static electricity) or to a drop in the power supply voltage.**

Hold down ⏻ (power) on the front panel for more than 15 seconds to reboot the unit. If the problem persists, disconnect the power cable from the AC wall outlet and plug it again.

■ The unit cannot be controlled using the remote control

- **The unit is out of the operating range.**

Use the remote control within the operating range. For details, see the following:

- “Operating range of the remote control” (p.6)

- **The batteries are weak.**

Replace with new batteries.

- **The unit’s remote control sensor is exposed to direct sunlight or strong lighting.**

Adjust the lighting angle, or reposition the unit.

- **The remote control IDs of the unit and the remote control are not identical.**

Change the remote control ID of the unit or the remote control. For details, see the following:

- “Selecting the remote control ID (REMOTE ID)” (p.86)

■ Cannot select the desired input source even if “INPUT” is pressed

- **The function which skips some input sources is set.**
Set “Input Skip” of the desired input source in the “Setup” menu to “Off”. For details, see the following:
 - “Setting input sources to be skipped when operating the INPUT key” (p.80)

■ The RED/GREEN/YELLOW/BLUE keys of the remote control do not operate

- **The device which is connected to the unit via HDMI does not support the operation of the RED/GREEN/YELLOW/BLUE keys.**
Use a device which supports the operation of the RED/GREEN/YELLOW/BLUE keys.
- **The settings of the RED/GREEN/YELLOW/BLUE keys of the unit's remote control have been changed.**
Set the “Remote Color Key” settings in the “Setup” menu to “Default”. For details, see the following:
 - “Setting the unit's functions for the RED/GREEN/YELLOW/BLUE keys of the remote control” (p.81)

Audio trouble

■ No sound

- **Another input source is selected.**
Select an appropriate input source with the input selection keys. For details, see the following:
 - “Basic procedure for playing back video and music” (p.36)
- **Signals that the unit cannot reproduce are being input.**
Some digital audio formats cannot be played back on the unit. Ensure that the signals are types that the unit is able to play back. For details on supported file formats, HDMI audio formats or compatible decoding format, see the following:
 - “Supported file formats” (p.101)
 - “Specifications” (p.106)
- **The cable connecting the unit and playback device is defective.**
If there is no problem with the connection, replace with another cable.

■ The volume cannot be increased

- **The maximum volume is set too low.**
Use “Max Volume” in the “Setup” menu to adjust the maximum volume. For details, see the following:
 - “Setting the limit value of the volume” (p.77)
- **A device connected to the output jacks of the unit is not turned on.**
Turn on all devices connected to the output jacks of the unit.

■ No sound is coming from a specific speaker

- **The playback source does not contain a signal for the channel.**
To check it, use "Signal Information" in the "Option" menu. For details, see the following:
 - "Checking information about the video/audio signals" (p.57)
- **The currently selected sound program/decoder does not use the speaker.**
To check it, use "Test Tone" in the "Setup" menu. For details, see the following:
 - "Outputting test tones" (p.71)
- **Audio output of the speaker is disabled.**
Perform YPAO or use "Configuration" in the "Setup" menu to change the speaker settings. For details, see the following:
 - "Optimizing the speaker settings automatically (YPAO)" (p.27)
 - "Setting the use of a subwoofer" (p.67)
 - "Setting the size of the front speakers" (p.67)
 - "Setting the use of a center speaker and its size" (p.68)
 - "Setting the use of surround speakers and their size" (p.68)
- **The volume of the speaker is set too low.**
Perform YPAO or use "Level" in the "Setup" menu to adjust the speaker volume. For details, see the following:
 - "Optimizing the speaker settings automatically (YPAO)" (p.27)
 - "Adjusting the volume of each speaker" (p.70)
- **The speaker cable connecting the unit and the speaker is defective.**
Check the unit's SPEAKERS terminals and the speaker's terminals. If there is no problem with the connection, replace a breaking speaker cable with another speaker cable.
- **The speaker is malfunctioning.**
To check it, replace with another speaker. If the problem persists with using another speaker, the unit may be malfunctioning.

■ No sound is coming from the subwoofer

- **The playback source does not contain Low Frequency Effect (LFE) or low-frequency signals.**
To check it, set "Extra Bass" in the "Setup" menu to "On", in order to output the front channel low-frequency components from the subwoofer. For details, see the following:
 - "Setting the use of Extra Bass" (p.69)
- **Subwoofer output is disabled.**
Perform YPAO or set "Subwoofer" in the "Setup" menu to "Use". For details, see the following:
 - "Optimizing the speaker settings automatically (YPAO)" (p.27)
 - "Setting the use of a subwoofer" (p.67)
- **The volume of the subwoofer is too low.**
Adjust the volume on the subwoofer.
- **The subwoofer has been turned off by its auto-standby function.**
Disable the auto-standby function of the subwoofer or adjust its sensitivity level.

■ No sound from the playback device connected to the unit with HDMI

- **The TV does not support HDCP (High-bandwidth Digital Content Protection).**
Refer to the instruction manuals for the TV and check the TV's specifications.
- **The number of devices connected to the HDMI OUT jack exceeds the limit.**
Disconnect some of the HDMI devices.

■ No sound from the TV when HDMI Control is used

- **The TV is set to output audio from the TV speakers.**

Change the audio output setting on your TV so that the TV audio is output from the speakers connected to the unit.
- **A TV that does not support ARC is connected to the unit only with an HDMI cable.**

Use a digital optical cable to make an audio connection. For details, see the following:

 - “HDMI connection with a TV” (p.21)
- **If the TV is connected to the unit with an audio cable, the TV audio input setting does not match the actual connection.**

Use “TV Audio Input” in the “Setup” menu to select the correct audio input jack. For details, see the following:

 - “Setting the audio jack used for TV audio input” (p.73)
- **If you are trying to use ARC, ARC is disabled on the unit or TV.**

Set “ARC” in the “Setup” menu to “On”, and enable ARC on the TV. For details, see the following:

 - “Setting the use of ARC” (p.73)

■ Only the front speakers work on multichannel audio

- **The playback device is set to output 2-channel audio (such as PCM) only.**

To check it, use “Signal Information” in the “Option” menu. If necessary, change the digital audio output setting on the playback device. For details, see the following:

 - “Checking information about the video/audio signals” (p.57)

■ Noise/hum is heard

- **The unit is too close to another digital or radio frequency device.**

Move the unit further away from the device.
- **The cable connecting the unit and playback device is defective.**

If there is no problem with the connection, replace with another cable.

■ The sound is distorted

- **The volume of the unit is too high.**

Turn down the volume. If “ECO Mode” in the “Setup” menu is set to “On”, set it to “Off”. For details, see the following:

 - “Setting the use of the eco mode” (p.78)
- **A device (such as an external power amplifier) connected to the unit’s audio output jacks is not turned on.**

Turn on all devices connected to the unit’s audio output jacks.

Video trouble

■ No video

- **Another input source is selected on the unit.**
Select an appropriate input source with the input selection keys.
- **Another input source is selected on the TV.**
Switch the TV input to display the video from the unit.
- **The video signal output from the unit is not supported by the TV.**
Check the video output setting of the playback device. For information about video signals supported by the TV, refer to the instruction manuals for the TV.
- **The cable connecting the unit and TV (or playback device) is defective.**
If there is no problem with the connection, replace with another cable.

■ No video from the playback device connected to the unit with HDMI

- **The input video signal (resolution) is not supported by the unit.**
To check the information about the current video signal (resolution) and video signals supported by the unit, see the following:
 - “Checking information about the video/audio signals” (p.57)
 - “HDMI signal compatibility” (p.104)
- **The TV does not support HDCP (High-bandwidth Digital Content Protection).**
Refer to the instruction manuals for the TV and check the TV's specifications.
- **The number of devices connected to the HDMI OUT jack is over the limit.**
Disconnect some of the HDMI devices.

■ No image (contents required the HDCP 2.2 - compatible HDMI device) from the playback device

- **The TV (HDMI input jack) does not support HDCP 2.2.**
Connect the unit to the TV (HDMI input jack) that supports HDCP 2.2. (The Warning message can be displayed on the TV screen.)

■ The menu of the unit is not displayed on the TV

- **The TV is not connected to the unit via HDMI.**
You can display the menu of the unit on the TV only when they are connected with an HDMI cable. If necessary, use an HDMI cable to connect them. For details, see the following:
 - “HDMI connection with a TV” (p.21)
- **Another input source is selected on the TV.**
Switch the TV input to display the video from the unit (HDMI OUT jack).

FM/AM radio trouble

■ FM radio reception is weak or noisy

- **There is multi-path interference.**

Adjust the FM antenna height or orientation, or place it in a different location.

- **Your area is too far from the FM station transmitter.**

To select monaural FM radio reception, set "FM Mode" in the "Option" menu to "Monaural". Or use an outdoor FM antenna. For details on "FM Mode", see the following:

– "Switching between stereo and monaural for FM radio reception" (p.59)

■ AM radio reception is weak or noisy

- **The noises may be caused by fluorescent lamps, motors, thermostats, or other electrical equipment.**

It is difficult to completely eliminate noise. It may be reduced by using an outdoor AM antenna.

■ Radio stations cannot be selected automatically

- **Your area is too far from the FM station transmitter.**

Select the station manually. Or use an outdoor antenna. We recommend using a sensitive multi-element antenna. For details on selecting the station manually, see the following:

– "Selecting a frequency for reception" (p.41)

- **The AM radio signal is weak.**

Adjust the AM antenna orientation. Select the station manually. Use an outdoor AM antenna. For details on selecting the station manually, see the following:

– "Selecting a frequency for reception" (p.41)

■ AM radio stations cannot be registered as presets

- **Auto Preset has been used.**

Auto Preset is for registering FM radio stations only. Register AM radio stations manually. For details, see the following:

– "Registering a radio station manually" (p.43)

USB trouble

■ The unit does not detect the USB device

- **The USB device is not connected to the USB jack securely.**

Turn off the unit, reconnect your USB device, and turn the unit on again.

- **The file system of the USB device is not FAT16 or FAT32.**

Use a USB device with FAT16 or FAT32 format.

■ Folders and files in the USB device cannot be viewed

- **The data in the USB device is protected by the encryption.**

Use a USB device without an encryption function.

■ The unit does not perform continuous playback on files of USB device

- **When the unit detects a series of unsupported files during playback, playback stops automatically.**

Do not save unsupported files (such as images and hidden files) in folders for playback.

Bluetooth® trouble

■ Cannot make the unit pair with a Bluetooth® device

- **Another Bluetooth device is connected.**
Terminate current Bluetooth connection, and perform pairing with the new device.
- **The unit and the Bluetooth device are too far apart.**
Move the Bluetooth device closer to the unit.
- **There is a device (such as microwave oven and wireless LAN) that outputs signals in the 2.4 GHz frequency band nearby.**
Move the unit away from those devices.
- **The Bluetooth device does not support A2DP.**
Perform pairing with a device which supports A2DP.

■ A Bluetooth® connection cannot be established

- **The Bluetooth function of the unit is disabled.**
Enable the Bluetooth function. For details, see the following:
 - “Setting the use of Bluetooth®” (p.82)
- **Another Bluetooth device is already connected to the unit.**
Terminate the current Bluetooth connection and then establish a new connection.
For details, see the following:
 - “Playback of Bluetooth® device contents” (p.47)
- **The pairing information has been deleted.**
Delete the pairing information on the device, and then perform pairing again. For details, see the following:
 - “Connecting a Bluetooth® device (pairing)” (p.46)The unit can be paired with sixteen devices. If pairing with a seventeenth device is performed, the pairing information with the earliest connection date will be deleted.
- **The unit and the Bluetooth device are too far apart.**
Move the Bluetooth device closer to the unit.
- **There is a device (such as microwave oven and wireless LAN) that outputs signals in the 2.4 GHz frequency band nearby.**
Move the unit and the Bluetooth device away from those devices.
- **The pairing information is removed from/not registered on the Bluetooth connection list.**
Perform pairing again. For details, see the following:
 - “Connecting a Bluetooth® device (pairing)” (p.46)

■ No sound is produced, or the sound is interrupted during playback with Bluetooth® connection

- **The volume of the Bluetooth device is set too low.**
Turn up the volume of the Bluetooth device.
- **The Bluetooth device is not set to send audio signals to the unit.**
Switch the audio output of the Bluetooth device to the unit.
- **The Bluetooth connection has been terminated.**
Establish a Bluetooth connection between the Bluetooth device and the unit again.
For details, see the following:
 - “Playback of Bluetooth® device contents” (p.47)
- **The unit and the Bluetooth device are too far apart.**
Move the Bluetooth device closer to the unit.
- **There is a device (such as microwave oven and wireless LAN) that outputs signals in the 2.4 GHz frequency band nearby.**
Move the unit and the Bluetooth device away from those devices.

Error indications on the front display

Error indications on the front display

Refer to the following table when the error message is indicated on the front display.

Message	Cause	Remedy
Access error	The unit cannot access the USB device.	Turn off the unit and reconnect your USB device. If the problem persists, try another USB device.
Check SP Wires	The speaker cables are short circuited.	Twist the bare wires of the cables firmly and connect to the unit and speakers properly. For details, see the following: <ul style="list-style-type: none">• "Connecting the speaker" (p.15)
Internal Error	An internal error has occurred.	Contact the nearest authorized Yamaha dealer or service center.
No content	There are no playable files in the selected folder.	Select a folder that contains files supported by the unit.
Not found	The Bluetooth device is not found.	<ul style="list-style-type: none">• Place the Bluetooth device within 10 m (32 ft) of the Bluetooth receiver.• Perform pairing again.
RemID Mismatch	The remote control IDs of the unit and the remote control are not identical.	Change the remote control ID of the unit or the remote control. For details, see the following: <ul style="list-style-type: none">• "Selecting the remote control ID (REMOTE ID)" (p.86)

APPENDIX

Input/output jacks and cables

Video/audio jacks

HDMI jacks

Transmit digital video and digital sound through a single jack. Use an HDMI cable.



Note

- Use a 19-pin HDMI cable with the HDMI logo. We recommend using a cable less than 5.0 m (16.4 ft) long to prevent signal quality degradation.
- The unit's HDMI jacks support the HDMI Control, Audio Return Channel (ARC), and 3D and 4K Ultra HD video transmission (through output) features.
- Use a Premium High Speed HDMI Cable or Premium High Speed Cable with Ethernet to enjoy 3D or 4K Ultra HD videos.

Video jacks

VIDEO jacks

Transmit analog video signals. Use a video pin cable.

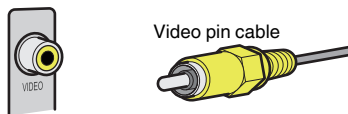

Audio jacks

OPTICAL jack

Transmit digital audio signals. Use a digital optical cable. If there is a protective cap on the tip of the cable, remove it before using the cable.



COAXIAL jacks

Transmit digital audio signals. Use a digital coaxial cable.



AUDIO jacks

Transmit analog stereo audio signals.

(Stereo L/R jacks)

Use a stereo pin cable (RCA cable).

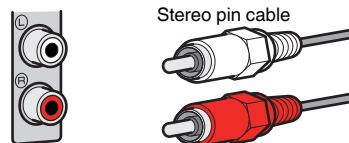

(Stereo mini jack)

Use a stereo mini-plug cable.



Glossary of audio information

Glossary of audio decoding format

This is a glossary of the technical terms related to audio decoding format used in this manual.

Dolby Digital

Dolby Digital is a compressed digital audio format developed by Dolby Laboratories, Inc. that supports 5.1-channel audio. This technology is used for audio on most DVD disc.

Dolby Digital Plus

Dolby Digital Plus is a compressed digital audio format developed by Dolby Laboratories, Inc. that supports 7.1-channel audio. Dolby Digital Plus remains fully compatible with the existing multichannel audio systems that support Dolby Digital. This technology is used for audio streaming services on the Internet and audio on BD (Blu-ray Disc).

Dolby Pro Logic II

Dolby Pro Logic II enables 5-channel playback from 2-channel sources. There are three modes available: "Music mode" for music sources, "Movie mode" for movie sources, and "Game mode" for game sources.

Dolby TrueHD

Dolby TrueHD is an advanced lossless audio format developed by Dolby Laboratories, Inc. to offer a high-definition home theater experience with the quality of the studio master. Dolby TrueHD can carry up to eight channels of 96 kHz/24-bit audio (up to six channels of 192 kHz/24-bit audio) simultaneously. This technology is used for audio on BD (Blu-ray Disc).

DTS 96/24

DTS 96/24 is a compressed digital audio format that supports 5.1-channel and 96 kHz/24-bit audio. This format remains fully compatible with the existing multichannel audio systems that support DTS Digital Surround. This technology is used for music DVDs, etc.

DTS Digital Surround

DTS Digital Surround is a compressed digital audio format developed by DTS, Inc. that supports 5.1-channel audio. This technology is used for audio on most DVD discs.

DTS Express

DTS Express is a compressed digital audio format that supports 5.1-channel audio and allows a higher compression rate than the DTS Digital Surround format developed by DTS, Inc. This technology is developed for audio streaming services on the Internet and secondary audio on BD (Blu-ray Disc).

DTS-HD High Resolution Audio

DTS-HD High Resolution Audio is a compressed digital audio format developed by DTS, Inc. that supports 7.1-channel and 96 kHz/24-bit audio. DTS-HD High Resolution Audio remains fully compatible with the existing multichannel audio systems that support DTS Digital Surround. This technology is used for audio on most BD (Blu-ray Disc).

DTS-HD Master Audio

DTS-HD Master Audio is an advanced lossless audio format developed to offer a high-definition home theater experience with the quality of the studio master by DTS, Inc. DTS-HD Master Audio can carry up to eight channels of 96 kHz/24-bit audio (up to six channels of 192 kHz/24-bit audio) simultaneously. This technology is used for audio on BD (Blu-ray Disc).

DTS Neo: 6

DTS Neo: 6 enables 6-channel playback from 2-channel sources. There are two modes available: "Music mode" for music sources and "Cinema mode" for movie sources. This technology provides discrete full-bandwidth matrix channels of surround sound.

DSD (Direct Stream Digital)

DSD (Direct Stream Digital) technology stores audio signals on digital storage media, such as SACD (Super Audio CDs). The signals are stored at a high-frequency sampling rate of 2.8224 MHz. The highest frequency response is equal to or higher than 100 kHz, with a dynamic range of 120 dB. This technology offers better audio quality than that used for CDs.

MP3

One of the compressed digital audio format used by MPEG. With psychoacoustic technologies, this compression method achieves a high compression rate. Reportedly, it is capable of compressing data quantity by about 1/10 maintaining a certain level of audio quality.

MPEG-4 AAC

An MPEG-4 audio standard. It is used for mobile telephones, portable audio players, and audio streaming services on Internet because it allows a high compression rate of data while maintaining better audio quality than MP3.

PCM (Pulse Code Modulation)

PCM is a signal format under which an analog audio signal is digitized, recorded, and transmitted. This technology is the basis of all other audio format. This technology is used as a lossless audio format called Linear PCM for audio on a variety of media, including CDs.

Sampling frequency/Quantization bit

Sampling frequency and quantization bits indicate the quantity of information when an analog audio signal is digitized. These values are noted as in the following example: "48 kHz/24-bit".

- Sampling frequency
Sampling frequency (the number of times the signal is sampled per second) is called the sampling rate. When the sampling frequency is higher, the range of frequencies that can be played back are wider.
- Quantization bit
The number of quantization bits indicate the degree of accuracy when converting the sound level into a numeric value. When the number of quantized bits is higher, the expression of the sound level is more accurate.

WAV

Windows standard audio file format, which defines the method of recording the digital data obtained by converting audio signals. By default, the PCM method (no compression) is used, but you can also use other compression methods.

WMA (Windows Media Audio)

One of the compressed digital audio formats developed by Microsoft Corporation. With psychoacoustic technologies, this compression method achieves a high compression rate. Reportedly, it is capable of compressing data quantity by about 1/20 maintaining a certain level of audio quality.

Glossary of audio information other than audio decoding format

This is a glossary of the technical terms related to audio information used in this manual.

Bi-amplification connection (Bi-amp)

A bi-amplification connection uses two amplifiers for a speaker. When you use the bi-amplification connection, the unit drives the tweeter and woofer in a speaker with the discrete amplifiers. As a consequence, the tweeter and woofer provide clear audio signal without the interference.

LFE (Low Frequency Effects) 0.1 channel

This channel reproduces low-frequency bass signals and has a frequency range from 20 Hz to 120 Hz. This channel is added to the channels for all bands with Dolby Digital or DTS to enhance low frequency audio effects. This channel is labeled 0.1 because it is limited to only low frequency audio.

Lip sync

Video output sometimes lags behind audio output due to the complexity of signal processing caused by an increase in video signal capacity. Lip sync is a technique for automatically correcting the timing lag between audio and video output.

Glossary of HDMI and video information

This is a glossary of the technical terms related to HDMI and video information used in this manual.

Composite video signal

With the composite video signal system, color, brightness, and synchronization data signals are combined and transmitted with a single cable.

Deep Color

Deep Color is a technology that HDMI specification supports. Deep Color increases the number of available colors within the boundaries defined by the RGB or YCbCr color space. Conventional color systems process the color using 8 bits. Deep Color processes the color with 10, 12, or 16 bits. This technology allows HDTVs and other displays to increase from millions of colors to billions of colors and eliminate on-screen color banding for smooth tonal transitions and subtle gradations between colors.

HDMI

HDMI (High-Definition Multimedia Interface) is the world-wide standard interface for digital audio/video signal transmission. This interface transmits both digital audio and digital video signals using a single cable without any loss. HDMI complies with HDCP (High-bandwidth Digital Content Protection) and provides a secure audio/video interface. For further information on HDMI, visit the HDMI website at "<http://www.hdmi.org/>".

x.v.Color

"x.v.Color" is a technology that the HDMI specification supports. It is a more extensive color space than sRGB and allows the expression of colors that were not hitherto possible. While remaining compatible with the color gamut of sRGB standards, "x.v.Color" expands the color space, and thus can produce more vivid, natural images.

Glossary of Yamaha technologies

This is a glossary of the technical terms related to Yamaha technologies used in this manual.

CINEMA DSP (Digital Sound Field Processor)

Since the surround sound systems were originally designed for use in movie theaters, their effect is best experienced in a theater that has many speakers designed for acoustic effects. Since home conditions (such as room size, wall material, and number of speakers) can differ so widely, it is inevitable that there are differences in the sound that you hear. Based on a wealth of actually measured data, CINEMA DSP, Yamaha's original DSP technology provides the audiovisual experience of a movie theater in your own home.

Compressed Music Enhancer

The Compressed Music Enhancer feature compensates for missing harmonics in compression music formats (such as MP3). As a result, this technology provides improved performance for the overall sound system.

SILENT CINEMA

Yamaha has developed a natural, realistic sound effect DSP algorithm for headphones. Parameters for headphones have been set for each sound program, so that accurate representations of all the sound programs can be enjoyed on headphones.

Virtual CINEMA DSP

Virtual CINEMA DSP allows the system to virtually reproduce the sound field of the surround speakers with front left and right speakers. Even if the surround speakers are not connected, the unit creates the realistic sound field in a listening room.

YPAO (Yamaha Parametric room Acoustic Optimizer)

The Yamaha Parametric room Acoustic Optimizer (YPAO) function detects speaker connections, measures the distances from them to your listening position(s), and then automatically optimizes the speaker settings, such as volume balance and acoustic parameters, to suit your room.

Supported devices and file formats

Supported Bluetooth® devices

The following Bluetooth devices can be used by the unit.

- Bluetooth devices that support A2DP can be used.
- Operation of all Bluetooth devices cannot be guaranteed.

Supported USB devices

The following USB devices can be used by the unit.

- This unit is compatible with USB memory devices that are in FAT16 or FAT32 format. Do not connect any other type of USB devices.
- USB devices with encryption cannot be used.
- Operation of all USB devices cannot be guaranteed.

Supported file formats

The following USB file formats can be used by the unit.

- The unit supports WAV (PCM format only), MP3, WMA and MPEG-4 AAC files (1- or 2-channel audio only).
- The unit is compatible with sampling rate of up to 48 kHz.
- Quantization bit rate of the unit is 16 bit only.
- Digital Rights Management (DRM) contents cannot be played back.

Video signal flow

Video signal flow

Video signals input from a video device to the unit are output to a TV as follows.

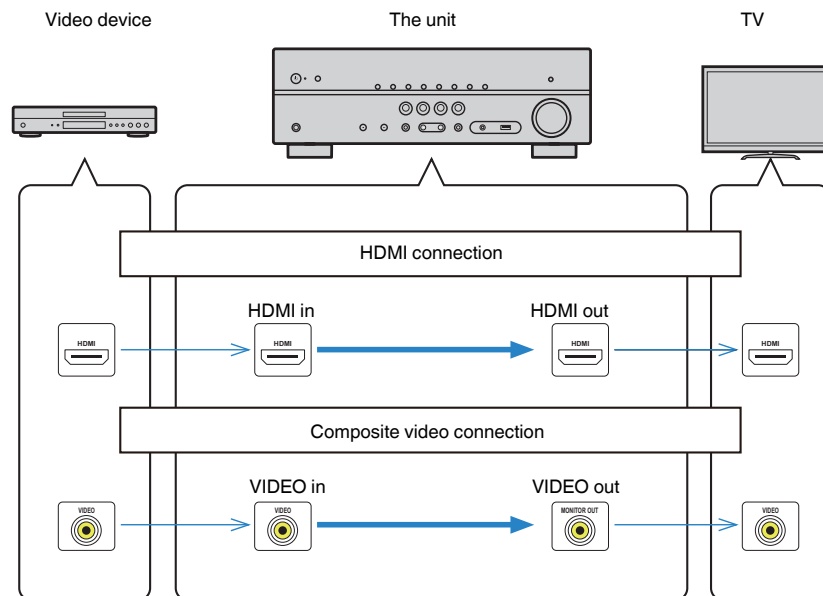

Additional information on HDMI

HDMI Control and synchronized operations

HDMI Control allows you to operate external devices via HDMI. If you connect a TV that supports HDMI Control to the unit with an HDMI cable, you can control the unit (such as power and volume) with TV remote control operations. You can also control external devices (such as HDMI Control-compatible BD/DVD players) connected to the unit with an HDMI cable.

Operations available from the TV's remote control

- Standby
- Volume control including mute
- Switching to input audio from the TV when the TV input is switched to its built-in tuner
- Switching to input video/audio from the selected playback device
- Switching between audio output devices (the unit or TV speaker)

(Example)

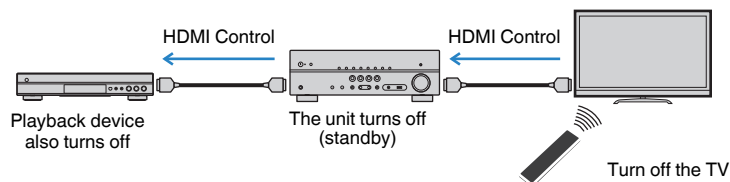

Operations available from the unit's remote control

- Starting playback on the playback device and turning on the TV with a scene selection
- Switching the TV input to display the "Setup" menu (when SETUP is pressed)
- Controlling the external device from which video is displayed on the TV (playback and menu operations)
- Controlling the TV when you select TV audio input that is set in "TV Audio Input" in the "Setup" menu
- Controlling the TV with the color (RED/GREEN/YELLOW/BLUE) keys of the remote control when "TV Control" is set for the color keys

(Example)

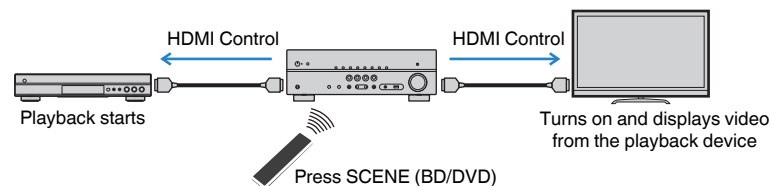

Note

- HDMI Control might not work properly.
- For details on the scene selection, see the following:
 - "Selecting a registered scene" (p.50)
- For details on TV audio input, see the following:
 - "Setting the audio jack used for TV audio input" (p.73)
- For details on the functions for the RED/GREEN/YELLOW/BLUE keys, see the following:
 - "Setting the unit's functions for the RED/GREEN/YELLOW/BLUE keys of the remote control" (p.81)

To use HDMI Control, you need to perform the following HDMI Control link setup after connecting the TV and playback devices.

For details on settings and operating your TV, refer to the instruction manual for the TV.

Note

This setup is required every time you add a new HDMI Control-compatible device to your system.

- 1 Turn on the unit, TV, and playback devices.**
- 2 Enable the HDMI Control function on the unit, TV and HDMI Control-compatible playback devices (such as BD/DVD players).**

In order to enable the HDMI Control function on the unit, set "HDMI Control" in the "Setup" menu to "On", and then configure the settings in related items ("TV Audio Input", "Standby Sync", "ARC" and "SCENE"). For details, see the following:

- "Setting the use of HDMI Control" (p.72)

- 3 Turn off the main power of the TV and then turn off the unit and playback devices.**

- 4 Turn on the unit and playback devices and then turn on the TV.**
- 5 Switch the TV input to display the video from the unit.**
- 6 Check that the input, to which the playback device is connected on the unit, is selected.**

If not, select the input source manually.
- 7 Check that the video from the playback device is displayed on the TV.**
- 8 Check that the unit is properly synchronized with the TV by turning off the TV or adjusting the TV volume with the TV remote control.**

Note

- If HDMI Control does not work properly, the problem may be solved by turning the playback device off and on again, or by unplugging the power plug and plugging it in again. Also, HDMI Control may not work properly if the number of connected devices exceeds the limit. In this case, disable HDMI Control on devices not in use.
- If the unit is not synchronized to the TV's power operations, check the priority of the audio output setting on the TV.
- We recommend using TV and playback devices from the same manufacturer so that HDMI Control works more effectively.

Audio Return Channel (ARC)

ARC allows you to input TV audio to the unit with the HDMI cable which transmits video signal to the TV.

Check the following after the HDMI Control settings.

Note

For details on the HDMI Control settings, see the following:

- "HDMI Control and synchronized operations" (p.102)

- 1 Select a TV program with the TV remote control.**
- 2 Check that the input source of the unit will be automatically switched to "AUDIO1" and the TV audio will be played back on the unit.**

If you cannot hear the TV audio, check the following:

- "ARC" in the "Setup" menu is set to "On". For details, see the following:
 - "Setting the use of ARC" (p.73)
- The HDMI cable is connected to the ARC-compatible HDMI jack (HDMI jack marked "ARC") on the TV.

Some HDMI jack on the TV is not compatible with ARC. For details, refer to the instruction manual for the TV.

Note

- If the audio is interrupted while using ARC, set "ARC" in the "Setup" menu to "Off" and use a digital optical cable to input TV audio to the unit. For details, see the following:
 - "Setting the use of ARC" (p.73)
 - "OPTICAL jack" (p.98)
- When using ARC, connect a TV with an HDMI cable that supports ARC.
- "AUDIO1" is set as TV audio input at the factory. If you have connected any external device to the AUDIO 1 jacks, use "TV Audio Input" in the "Setup" menu to change the TV audio input assignment. To use the SCENE function, you also need to change the input assignment for SCENE (TV). For details, see the following:
 - "Setting the audio jack used for TV audio input" (p.73)
 - "Registering a scene" (p.51)

HDMI signal compatibility

Confirm the following HDMI signal used by the unit.

- When CPPM copy-protected DVD-Audio is played back, video/audio signals may not be output, depending on the type of the DVD player.
- The unit is not compatible with HDCP-incompatible HDMI or DVI devices. For details, refer to the instruction manual for each device.
- To decode audio bitstream signals on the unit, set the playback device appropriately so that the device outputs the bitstream audio signals directly (does not decode the bitstream signals on the playback device). For details, refer to the instruction manual for the playback device.
- If the playback device can decode the bitstream audio signals of audio commentaries, you can play back the audio sources with the audio commentaries mixed down by using digital audio input (OPTICAL or COAXIAL jacks). For details, refer to the instruction manual for the playback device. The unit is not compatible with audio commentaries for BD, such as audio content downloaded from the internet.

Trademarks

The trademarks used in this manual are as follows.



Manufactured under license from Dolby Laboratories. Dolby, Dolby Audio, Pro Logic, Dolby Vision, and the double-D symbol are trademarks of Dolby Laboratories.



For DTS patents, see <http://patents.dts.com>. Manufactured under license from DTS Licensing Limited. DTS, DTS-HD, the Symbol, & DTS and the Symbol together are registered trademarks of DTS, Inc. © DTS, Inc. All Rights Reserved.



The terms HDMI, the HDMI Logo, and High-Definition Multimedia Interface are trademarks or registered trademarks of HDMI Licensing LLC in the United States and other countries.

x.v.Color™

"x.v.Color" is a trademark of Sony Corporation.



The Bluetooth® word mark and logos are registered trademarks owned by Bluetooth SIG, Inc. and any use of such marks by Yamaha Corporation is under license.

App Store is a service mark of Apple Inc.

Android™ is a trademark of Google Inc.



"SILENT CINEMA" is a trademark of Yamaha Corporation.

Google Noto Fonts

This product uses the following fonts.

Copyright © June 2015, Google
(<https://www.google.com/get/noto/#sans-lgc>), with Reserved Font Name Noto Sans Version 1.004.

Copyright © June 2015, Google
(<https://www.google.com/get/noto/help/cjk/>), with Reserved Font Name Noto Sans CJK Version 1.004.

This Font Software is licensed under the SIL Open Font License, Version 1.1.

This license is available with a FAQ at: <http://scripts.sil.org/OFL>

Specifications

The specifications of this unit are as follows.

Input jacks

Analog Audio

- Audio x 3 (including AUX)

Digital Audio (Supported frequencies: 32 kHz to 96 kHz)

- Optical x 1
- Coaxial x 2

Video

- Composite x 3

HDMI Input

- HDMI x 4

Other jacks

- USB x 1 (USB2.0)

Output jacks

Analog Audio

- Speaker Out x 5 (FRONT L/R, CENTER, SURROUND L/R*)
* Note: assignment is possible [SURROUND, BI-AMP (FRONT L/R)]
- Subwoofer Out x 1
- Headphone x 1

Video

- Composite x 1

HDMI Output

- HDMI OUT x 1

Other jacks

YPAO MIC x 1

HDMI

HDMI Features:

- 4K UltraHD Video (include 4K/60, 50Hz 10/12bit), 3D Video, ARC (Audio Return Channel), HDMI Control (CEC), Auto Lip Sync, Deep Color, "x.v.Color", HD audio playback, Selectable HDMI input in HDMI standby mode, 21:9 Aspect Ratio, BT.2020 Colorimetry, HDR Compatible (HDR10, Dolby Vision, HLG)

Video Format (Repeater Mode)

- VGA
- 480i/60 Hz
- 576i/50 Hz
- 480p/60 Hz
- 576p/50 Hz
- 720p/60 Hz, 50 Hz
- 1080i/60 Hz, 50 Hz
- 1080p/60 Hz, 50 Hz, 30 Hz, 25 Hz, 24 Hz
- 4K/60Hz, 50Hz, 30 Hz, 25 Hz, 24 Hz

Audio Format

- Dolby TrueHD
- Dolby Digital Plus
- Dolby Digital
- DTS-HD Master Audio
- DTS-HD High Resolution Audio
- DTS Express
- DTS
- DSD 2-ch to 6-ch (2.8 MHz)
- PCM 2-ch to 8-ch (Max. 192 kHz/24-bit)

Content Protection: HDCP 2.2 compatible

Link Function: CEC supported

TUNER

Analog Tuner

- [U.K., Europe and Russia models]
FM/AM with Radio Data System x 1 (TUNER)
- [Other models]
FM/AM x 1 (TUNER)

USB

Capable of Mass Storage Class USB Memory

Current Supply Capacity: 0.5 A

Bluetooth

Bluetooth version

- Ver. 2.1+EDR

Supported profile

- A2DP

Supported codec

- SBC

Wireless output

- Bluetooth Class 2

Maximum communication distance

- 10 m (33 ft) without interference

Compatible Decoding Formats

Decoding Format

- Dolby TrueHD, Dolby Digital Plus
- Dolby Digital
- DTS-HD Master Audio, DTS-HD High Resolution Audio, DTS Express
- DTS, DTS 96/24

Post Decoding Format

- Dolby Pro Logic II Music, Dolby Pro Logic II Movie, Dolby Pro Logic II Game
- DTS Neo: 6 Music, DTS Neo: 6 Cinema

Audio Section

Rated Output Power (2-channel driven)

- [U.S.A. and Canada models] (20 Hz to 20 kHz, 0.09% THD, 8 Ω)
- [Other models] (20 Hz to 20 kHz, 0.09% THD, 6 Ω)
 - Front L/R 70 W+70 W
- [U.S.A. and Canada models] (1 kHz, 0.9% THD, 8 Ω)
 - Front L/R 85 W+85 W
 - Center 85 W
 - Surround L/R 85 W+85 W

Rated Output Power (1-channel driven)

- [U.S.A. and Canada models] (1 kHz, 0.9% THD, 8 Ω)
- [Other models] (1 kHz, 0.9% THD, 6 Ω)
 - Front L/R, Center, Surround L/R 100 W/ch

Maximum Effective Output Power (1-channel driven)

- [U.S.A. and Canada models] (1 kHz, 10% THD, 8 Ω)
 - Front L/R, Center, Surround L/R 130 W/ch
- [U.S.A. and Canada models] (1 kHz, 10% THD, 6 Ω)
 - Front L/R, Center, Surround L/R 145 W/ch
- [Other models] (1 kHz, 10% THD, 6 Ω)
 - Front L/R, Center, Surround L/R 135 W/ch

Dynamic Power (IHF)

- [U.S.A. and Canada models]
 - Front L/R (8/6/4/2 Ω) 110/130/160/180 W
- [Other models]
 - Front L/R (6/4/2 Ω) 110/130/150 W

Damping Factor

- Front L/R, 20 Hz to 20 kHz, 8 Ω 100 or more

Input Sensitivity / Input Impedance

- AV 2 etc. (1 kHz, 100 W/6 Ω) 200 mV/47 k Ω

Maximum Input Signal

- AV 2 etc. (1 kHz, 0.5% THD, Effect On) 2.3 V

Output Level / Output Impedance

- SUBWOOFER 1 V/1.2 k Ω

Headphone Jack Rated Output / Impedance

- AV 2 etc. (1 kHz, 50 mV, 8 Ω) 100 mV/470 Ω

Frequency Response

- AV 2 etc. to Front (10 Hz to 100 kHz) +0/-3 dB

Signal to Noise Ratio (IHF-A Network)

- AV 2 etc. (Input 1 k Ω Shorted, Speaker Out) 110 dB or more

Residual Noise (IHF-A Network)	
• Front L/R (Speaker Out)	150 μ V or less
Channel Separation	
• AV 2 etc. (Input 1 k Ω Shorted, 1 kHz/10 kHz)	70 dB/50 dB or more
Volume Control	
• Range	MUTE, -80 dB to +16.5 dB
• Step	0.5 dB
Tone Control Characteristics	
• Bass Boost/Cut	\pm 6 dB/0.5 dB Step at 50 Hz
• Bass Turnover	350 Hz
• Treble Boost/Cut	\pm 6 dB/0.5 dB Step at 20 kHz
• Treble Turnover	3.5 kHz
Filter Characteristics (fc=40/60/80/90/100/110/120/160/200 Hz)	
• H.P.F. (Front, Center, Surround)	12 dB/oct.
• L.P.F. (Subwoofer)	24 dB/oct.

Video Section

Video Signal Type	
• [U.S.A., Canada, Korea, Taiwan, Brazil and Central and South America models]	NTSC
• [Other models]	PAL
Video Signal Level	
• Composite	1 Vp-p/75 Ω
Video Maximum Input Level	
	1.5 Vp-p or more
Video Signal to Noise Ratio	
	50 dB or more

FM Section

Tuning Range	
• [U.S.A. and Canada models]	87.5 MHz to 107.9 MHz
• [Asia, Taiwan, Brazil and Central and South America models]	87.5/87.50 MHz to 108.0/108.00 MHz
• [U.K. and Europe models]	87.50 MHz to 108.00 MHz
• [Other models]	87.50 MHz to 108.00 MHz
50 dB Quiet Sensitivity (IHF, 1 kHz, 100% MOD.)	
• Monaural	3 μ V (20.8 dBf)
Signal to Noise Ratio (IHF)	
• Monaural	65 dB
• Stereo	64 dB
Harmonic Distortion (IHF, 1 kHz)	
• Monaural	0.5%
• Stereo	0.6%
Antenna Input	
	75 Ω unbalanced

AM section

Tuning Range	
• [U.S.A. and Canada models]	530 kHz to 1710 kHz
• [Asia, Taiwan, Brazil and Central and South America models]	530/531 kHz to 1710/1611 kHz
• [U.K. and Europe models]	531 kHz to 1611 kHz
• [Other models]	531 kHz to 1611 kHz

General

Power Supply

- [U.S.A. and Canada models] AC 120 V, 60 Hz
 - [Brazil and Central and South America models] AC 110 to 120/220 to 240 V, 50/60 Hz
 - [Taiwan model] AC 110 to 120 V, 50/60 Hz
 - [China model] AC 220 V, 50 Hz
 - [Korea model] AC 220 V, 60 Hz
 - [Australia model] AC 240 V, 50 Hz
 - [U.K., Europe and Russia models] AC 230 V, 50 Hz
 - [Asia model] AC 220 to 240 V, 50/60 Hz
-

Power Consumption

260 W

Standby Power Consumption

- HDMI Control Off, Standby Through Off, Bluetooth Standby Off 0.2 W
 - HDMI Control On, Standby Through Auto (HDMI No Signals), Bluetooth Standby Off 1.2 W
 - HDMI Control On, Standby Through On (HDMI No Signals), Bluetooth Standby Off 1.2 W
 - HDMI Control Off, Standby Through Off, Bluetooth Standby On 0.2 W
 - HDMI Control On, Standby Through Auto (HDMI No Signals), Bluetooth Standby On 1.2 W
 - HDMI Control On, Standby Through On (HDMI No Signals), Bluetooth Standby On 1.2 W
-

Maximum Power Consumption

600 W

Dimensions (W x H x D)

435 x 161 x 315 mm (17-1/8" x 6-3/8" x 12-3/8")

Weight

7.7 kg (17.0 lbs)

* The contents of this manual apply to the latest specifications as of the publishing date. To obtain the latest manual, access the Yamaha website then download the manual file.

Default settings

Default settings of the Option menu

The default settings of the "Option" menu are as follows.

Tone Control	Treble, Bass Bypass (0.0 dB)
* When both "Treble" and "Bass" are 0.0 dB, "Bypass" appears.	
DSP/Surround	
• DSP Level	0 dB
• Adaptive DRC	Off
• Enhancer	
– TUNER, Bluetooth, USB	On
– Others	Off
Volume Trim	
• Input Trim	0.0 dB
• Subwoofer Trim	0.0 dB
Lipsync	On
Video Out	Off
FM Mode	Stereo
Repeat	Off
Input Interlock	On

Default settings of the Setup menu

The default settings of the "Setup" menu are as follows.

Speaker

Configuration	
• Power Amp Assign	Surround
• Subwoofer	Use
• Front	Small
• Center	Small
• Surround	Small
• Crossover	80 Hz
• Subwoofer Phase	Normal
• Extra Bass	Off
• Virtual CINEMA FRONT	Off
Distance	3.00 m (10.0 ft)
Level	0.0 dB
Equalizer	Off
Test Tone	Off

HDMI

HDMI Control	Off
Audio Output	Off
Standby Through	Off
4K Upscaling	Off
HDCP Version	
• HDMI 1-4	Auto

TV Audio Input	AUDIO1
Standby Sync	Auto
ARC	On
SCENE	
• BD / DVD, TV	On
• CD, RADIO	Off

Sound

DSP Parameter	
• Panorama	Off
• Center Width	3
• Dimension	0
• Center Image	0.3
• Monaural Mix	Off
Lipsync	
• Select	Auto
(This setting is effective when a TV that supports an automatic lipsync function is connected to the unit via HDMI.)	
• Adjustment	0 ms
Dialogue	
• Dialogue Level	0
Volume	
• Scale	dB
• Dynamic Range	Maximum
• Max Volume	+16.5 dB
• Initial Volume	Off

ECO

Auto Power Standby	
• U.K., Europe, Russia and Korea models	20 minutes
• Other models	Off

ECO Mode	Off
----------	-----

Function

Input Rename	
• HDMI 1-4	Auto
• Others	Manual
(For AUX, TUNER, USB only "Manual" can be selected.)	

Input Skip	Off
------------	-----

Dimmer	0
--------	---

Memory Guard	Off
--------------	-----

Remote Color Key	Default
------------------	---------

Bluetooth

Bluetooth	On
-----------	----

Audio Receive	
• Disconnect	-
• Bluetooth Standby	On

Audio Send	
• Transmitter	Off
• Device Search	-

Language

English

Default settings of the ADVANCED SETUP menu

The default settings of the "ADVANCED SETUP" menu are as follows.

SP IMP. (U.S.A. and Canada models only)	8 Ω MIN
--	---------

REMOTE ID	ID1
-----------	-----

TU (Asia, Taiwan, Brazil and Central and South America models only)	FM50/AM9
--	----------

TV FORMAT	
• U.S.A., Canada, Korea, Taiwan, Brazil and Central and South America models	NTSC
• Other models	PAL

4K MODE	MODE 1
---------	--------

INIT	CANCEL
------	--------

UPDATE	USB
--------	-----

VERSION	-
---------	---

Yamaha Global Site
<https://www.yamaha.com/>

Yamaha Downloads
<http://download.yamaha.com/>

Manual Development Group
© 2018 Yamaha Corporation

Published 02/2018 NV-A0

AV17-0101