



# REMOTE COMMUNICATION SOLUTIONS

# REMOTE COMMUNICATION SOLUTIONS

In addition to web conferencing and distance learning, there is also a need for solutions that offer other forms of communication such as hybrid conferencing and HyFlex (hybrid-flexible) learning. Yamaha's audio equipment supports all forms of communication within a comfortable space. We offer a range of equipment and system configurations for school, university, and corporate settings to suit the size of the room and number of participants.

## INDEX

SOLUTIONS FOR SCHOOLS	<b>P02</b>
SOLUTIONS FOR UNIVERSITIES	<b>P10</b>
SOLUTIONS FOR BUSINESSES	<b>P24</b>
PRODUCT INFORMATION	<b>P38</b>



**CALENDER** What's the date today?

December	March	June	September	1	2	3												
January	April	July	October	4	5	6												
February	May	August	November	7	8	9												
MON	TUE	WED	THU	FRI	SAT	SUN	10	11	12									
Monday	Tuesday	Wednesday	Thursday	Friday	Saturday	Sunday	1	2	3	4	5	6	7	8	9	0	1	2

What's the season?  
 Winter Spring Summer Autumn

How do you feel today?  
 Happy Good Excited Sleepy Not so good

How's the weather today?  
 Sunny Cloudy Windy Rainy Stormy Snowy

Distillation

Ice cubes  
 condensation  
 Clear Water  
 Magnet  
 generated

# SOLUTIONS FOR SCHOOLS

Number of  
Participants

4

## SMALL CLASSROOM



The perfect plug-and-play solution for small-scale distance learning. The microphone and speaker come as a single unit for easy carrying. SoundCap technology provides clear audio even in noisy environments.

### Features

- Equipped with Human Voice Activity Detection (HVAD), Yamaha's unique intelligent voice signal processing technology that distinguishes human voices from ambient noise.
- Adaptive Echo Canceller for two-way conversations without the sound breaking up.
- Automatic Gain Control adjusts the volume of human voices from both near and far from the microphone.
- USB connection without the need for a dedicated driver.
- Zoom certified.

### System Configuration

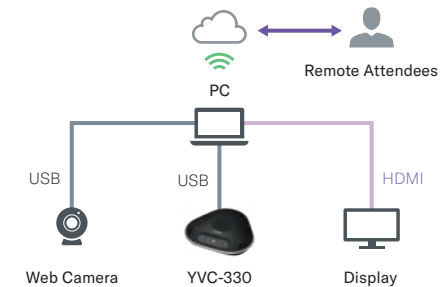

### Configuration Devices

YVC-330 [P38](#)

Number of  
Participants

6-10

## SMALL CLASSROOM



**The perfect plug-and-play solution for small-scale distance learning. The microphone and speaker come as a single unit for easy carrying. SoundCap technology provides clear audio even in noisy environments.**

### Features

- Equipped with Human Voice Activity Detection (HVAD), Yamaha's unique intelligent voice signal processing technology that distinguishes human voices from ambient noise.
- Adaptive Echo Canceller for two-way conversations without the sound breaking up.
- Automatic Gain Control adjusts the volume of human voices from both near and far from the microphone.
- USB connection without the need for a dedicated driver.
- Zoom certified.
- Sound pickup and playback range can be extended by connecting in series.

### System Configuration

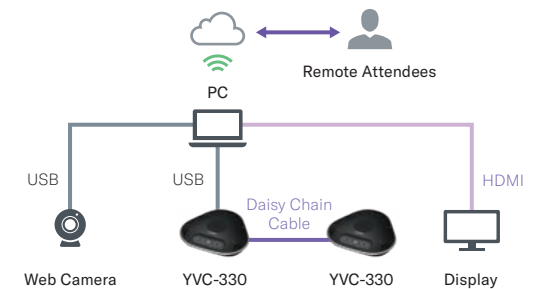

### Configuration Devices

**YVC-330** P38

Number of  
Participants

10-20

## SMALL CLASSROOM



**Automatic adjustment of speaker volume to match ambient noise. Automatic muting when no one is speaking to efficiently cut out unnecessary noise. Easy installation with camera, microphone, and speaker in a single unit that can be connected to a PC with just USB.**

### Features

- Smart Framing automatically picks up the face of the person speaking.
- Accurate microphone beamforming even in a compact product.
- Intuitive remote control.
- Flexible installation options with a variety of mounting hardware.
- The best full-range mono speakers for audio playback.
- Zoom certified.

### System Configuration

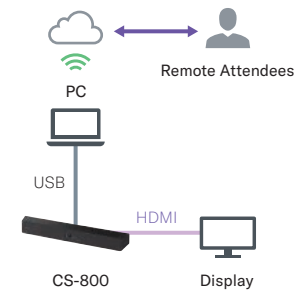

### Configuration Devices

**CS-800** [P38](#)

Number of  
Participants

10-20

## MID-SIZED CONFERENCE ROOM



The YVC-1000 is equipped with a wealth of audio processing technology that automatically optimizes sound quality. It contributes to a pleasant teleconferencing experience, and allows microphone extensions to accommodate the layout and number of people.

### Features

- Automatic Room EQ optimizes the acoustic settings according to the sound environment within the room.
- Adaptive Echo Canceller for stress-free two-way conversations.
- Noise Reduction cuts down on noise and delivers only human voices to participants on the other end.
- Automatic Tracking follows the person speaking.
- Automatic Gain Control automatically adjusts volume according to the distance of the person speaking from the microphone.
- Dereverberation suppresses echo in spaces where voices easily resonate, and delivers clear audio to the other end of the call.
- Zoom and Barco certified.
- External microphone and speaker extensions can accommodate the room layout and number of participants.

### System Configuration

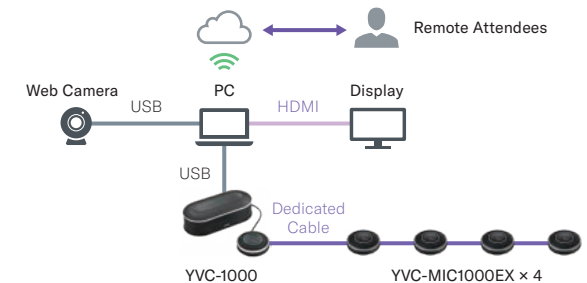

### Configuration Devices

YVC-1000 / YVC-MIC1000EX P38

Number of  
Participants

20-30

## MID-SIZED CLASSROOM



Clearly delivers the voices of the teacher and students to the far-end and students far away from the teacher. The separate speaker and microphone setup offers excellent portability, scalability, and connectivity to a PC via a simple USB connection. The teacher's voice can also be amplified, providing high-quality lessons and lectures, even in remote locations.

### Features

- Equipped with Human Voice Activity Detection (HVAD), Yamaha's unique intelligent voice signal processing technology that distinguishes human voices from ambient noise.
- Noise Reduction cuts down on noise and transmits voices only.
- Adaptive Echo Canceller for two-way conversations without the sound breaking up.
- Automatic Gain Control adjusts the volume of human voices from both near and far from the microphone.
- Automatic Room EQ adjusts the speaker playback sound for ease of hearing.
- Zoom and Barco certified.

### System Configuration

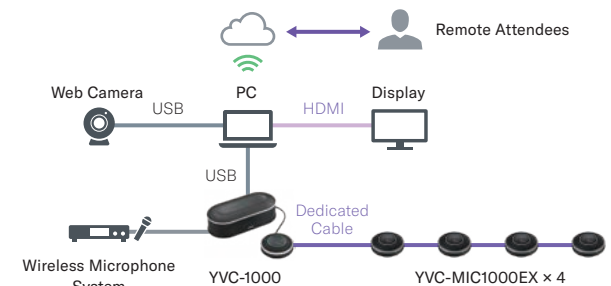

### Configuration Devices

YVC-1000 / YVC-MIC1000EX P38



Number of  
Participants

20-40

## MULTIPURPOSE ROOM



Delivers the voices of the teacher and students clearly to other students far away. The separate speaker and microphone setup offers excellent portability and scalability, and connectivity to a PC via a simple USB connection. The teacher's voice can also be amplified, serving to provide high-quality classes, even in remote locations.

### YVC-1000 Features

- Equipped with Human Voice Activity Detection (HVAD), Yamaha's unique intelligent voice signal processing technology that distinguishes human voices from ambient noise.
- Noise Reduction cuts down on noise and transmits voices only.
- Adaptive Echo Canceller for two-way conversations without the sound breaking up.
- Automatic Gain Control adjusts the volume of human voices from both near and far from the microphone.
- Automatic Room EQ adjusts the speaker playback sound for ease of hearing.
- Zoom and Barco certified.

### STAGEPAS 1K mkII Features

- Compact but powerful all-in-one package.
- Slim line array with 10 small-diameter 1.5" units in a J-curve configuration.

### System Configuration

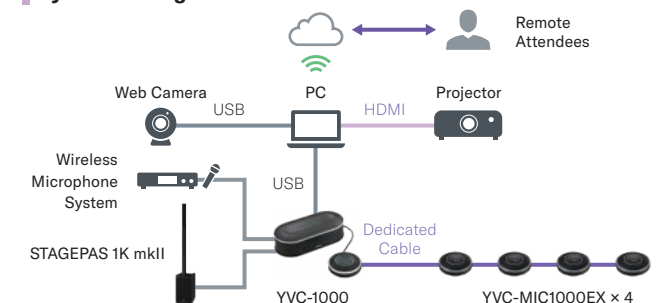

### Configuration Devices

YVC-1000 / YVC-MIC1000EX / STAGEPAS 1K mkII P38,42

Number of Participants

20-40

## LARGE CLASSROOM



Delivers the voices of the teacher and students clearly to other students far away. The separate speaker and microphone setup offers excellent portability and scalability, and connectivity to a PC via a simple USB connection. The teacher's voice can also be amplified, serving to provide high-quality classes, even in remote locations.

### YVC-1000 Features

- Equipped with Human Voice Activity Detection (HVAD), Yamaha's unique intelligent voice signal processing technology that distinguishes human voices from ambient noise.
- Noise Reduction cuts down on noise and transmits voices only.
- Adaptive Echo Canceller for two-way conversations without the sound breaking up.
- Automatic Gain Control adjusts the volume of human voices from both near and far from the microphone.
- Automatic Room EQ adjusts the speaker playback sound for ease of hearing.
- Zoom and Barco certified.

### STAGEPAS 400BT Features

- Highly portable all-in-one PA package.
- Speaker design for expressive and articulate sound.
- Equipped with Feedback Suppressor that automatically removes unpleasant feedback.

### System Configuration

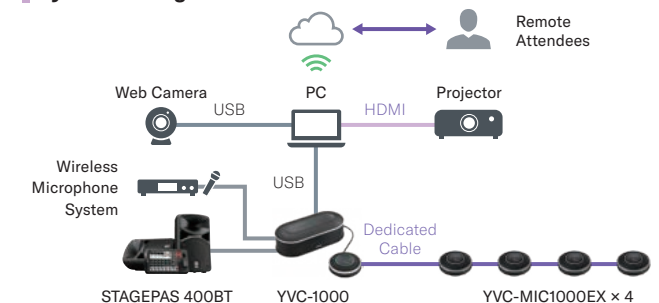

### Configuration Devices

YVC-1000 / YVC-MIC1000EX / STAGEPAS 400BT P38,42



SOLUTIONS  
FOR **UNIVERSITIES**

Number of  
Participants

1-4

## MEETING SPACE OR HOME



Meeting Space



Home

Participate in classes from anywhere. The microphone and speaker come as a single unit for easy carrying, and the product features a USB connection, removing the need for a dedicated driver.

### Features

- Equipped with Human Voice Activity Detection (HVAD), Yamaha's unique intelligent voice signal processing technology that distinguishes human voices from ambient noise.
- Adaptive Echo Canceller for two-way conversations without the sound breaking up.
- Noise Reduction gets rid of noise and transmits voices only.

### System Configuration

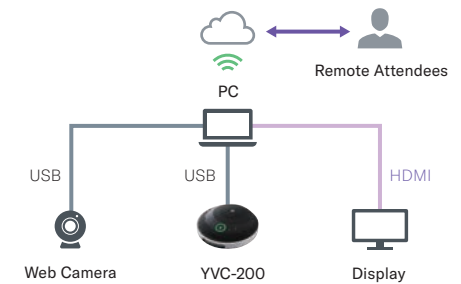

### Configuration Devices

YVC-200 [P38](#)

Number of  
Participants

6-10

## LABORATORY



Automatic adjustment of speaker volume to match ambient noise. Automatic muting when no one is speaking to efficiently cut out unnecessary noise. Easy installation with camera and microphone in a single unit that can be connected to a PC via USB.

### Features

- Smart Framing automatically picks up the face of the person speaking.
- Accurate microphone beamforming even in a compact product.
- Intuitive remote control.
- Flexible installation options with a variety of mounting hardware.
- Zoom certified.

### System Configuration

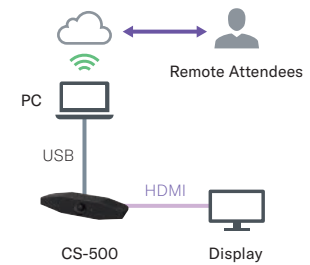

### Configuration Devices

CS-500 P38

Number of  
Participants

6-10

## SMALL CLASSROOM



The CS-800's unique SoundCap Eye feature tracks the position and speech of participants to properly capture sound. Natural teleconferencing can be achieved even in open spaces and other noisy environments.

### Features

- Face Focus Beamforming tracks participants' faces analyzed by AI, picks up sound, and frames the video.
- Self-Silence separates human voices from noise, and automatically mutes microphones when participants are not speaking.
- Self-Volume Balancer constantly adjusts the speaker to the appropriate level based on the level of ambient noise.
- Microphones arranged in a hexagonal array form a three-dimensional microphone beam to pick up sound clearly and accurately.
- Recognizing people causes the display to automatically start up and show the on-screen user guide.

### System Configuration

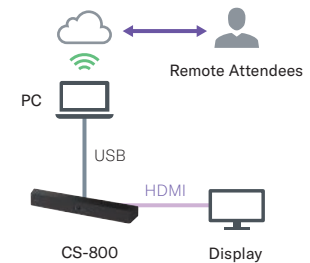

### Configuration Devices

CS-800 P38

Number of  
Participants

8-16

## SMALL/MID-SIZED CLASSROOM OR TRAINING ROOM



Delivers the voices of the teacher and students clearly to other students far away. The separate speaker and microphone setup offers excellent portability and scalability, and connectivity to a PC via a simple USB connection. The teacher's voice can also be amplified, serving to provide high-quality classes, even in remote locations.

### Features

- Equipped with Human Voice Activity Detection (HVAD), Yamaha's unique intelligent voice signal processing technology that distinguishes human voices from ambient noise.
- Noise Reduction cuts down on noise and transmits voices only.
- Adaptive Echo Canceller for two-way conversations without the sound breaking up.
- Automatic Gain Control adjusts the volume of human voices from both near and far from the microphone.
- Automatic Room EQ adjusts the speaker playback sound for ease of hearing.
- Zoom and Barco certified.

### System Configuration

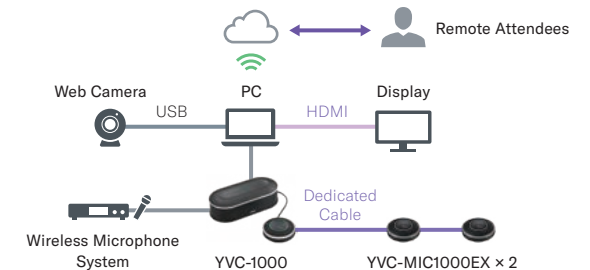

### Configuration Devices

YVC-1000 / YVC-MIC1000EX P38

Number of  
Participants

10-20

## MID-SIZED CLASSROOM



The ceiling microphone allows the classroom to serve as a venue for lively Q&A by picking up speakers' voices with precision while maintaining clarity. The instructor uses a hand microphone for self-amplification, with line array speakers providing clear audio to students in the back.

### Features

- Equipped with Multi-beam Tracking that uses four beams to follow multiple people speaking simultaneously without missing a sound.
- Human Voice Activity Detection (HVAD) achieves pleasant calling with high-precision voice processing.
- Adaptive Echo Canceller with high echo cancellation performance.
- Noise Reduction greatly reduces ambient and background noise.
- Automatic Gain Control for comfortable conversations and easy-to-hear voices.
- Line array speakers with a slim design only 54 millimeters wide and with high sound quality.
- Microsoft Teams certified (RM-CG, RM-CR).

### System Configuration

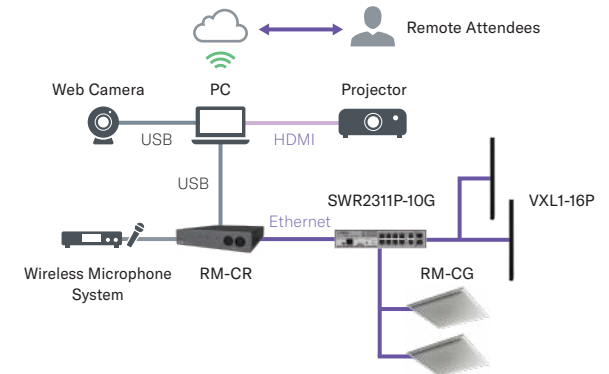

### Configuration Devices

ADECIA CEILING SOLUTION P39-40



Number of  
Participants

10-20

## MID-SIZED CLASSROOM



The clear voices of the teacher and students are delivered to other students far away. The separate speaker and microphone setup offers excellent portability and scalability, and connectivity to a PC via a simple USB connection. The teacher's voice can also be amplified, serving to provide high-quality classes, even in remote locations.

### YVC-1000 Features

- Equipped with Human Voice Activity Detection (HVAD), Yamaha's unique intelligent voice signal processing technology that distinguishes human voices from ambient noise.
- Noise Reduction cuts down on noise and transmits voices only.
- Adaptive Echo Canceller for two-way conversations without the sound breaking up.
- Automatic Gain Control adjusts the volume of human voices from both near and far from the microphone.
- Automatic Room EQ adjusts the speaker playback sound for ease of hearing.
- Zoom and Barco certified.

### STAGEPAS 1K mkII Features

- Compact but powerful all-in-one package
- Slim line array with 10 small-diameter 1.5" units in a J-curve configuration.

### System Configuration

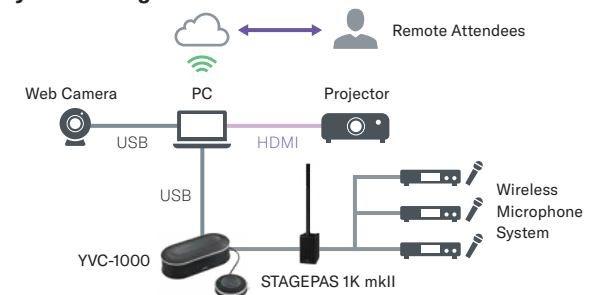

### Configuration Devices

YVC-1000 / STAGEPAS 1K mkII P38.41

Number of  
Participants

10-20

## MID-SIZED CLASSROOM



Tabletop microphones can be used to pinpoint and pick up the questions from students at each cluster of desks. The instructor uses a hand microphone for self-amplification, with line array speakers providing clear audio to students in the back.

### Features

- Adaptive Echo Canceller with high echo cancellation performance.
- Noise Reduction greatly reduces ambient and background noise.
- Automatic Gain Control for comfortable conversations and easy-to-hear voices.
- Line array speakers with a slim design only 54 millimeters wide and with high sound quality.
- Microsoft Teams certified (RM-TT, RM-CR).

### System Configuration

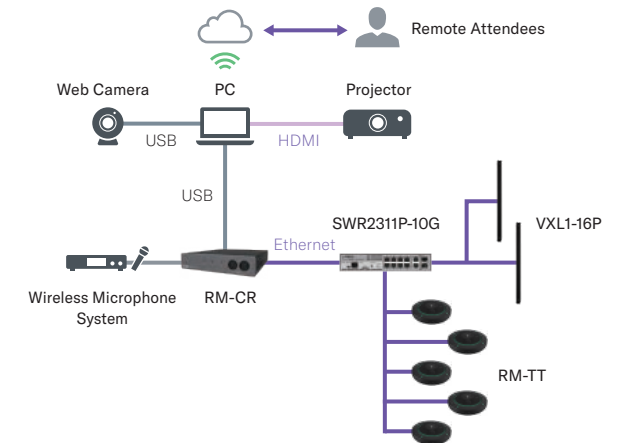

### Configuration Devices

ADECIA TABLETOP SOLUTION P39-40

Number of  
Participants

8-16

## MID-SIZED CLASSROOM



For meetings in mid-sized classroom, the ADECIA Tabletop Solution is ideal. Up to 14 microphones can be added according to the number of participants, with line array speakers providing clear audio to students in the back.

### Features

- Adaptive Echo Canceller with high echo cancellation performance.
- Noise Reduction greatly reduces ambient and background noise.
- Automatic Gain Control for comfortable conversations and easy-to-hear voices.
- Line array speakers with a slim design only 54 millimeters wide and with high sound quality.
- Microsoft Teams certified (RM-TT, RM-CR).

### System Configuration

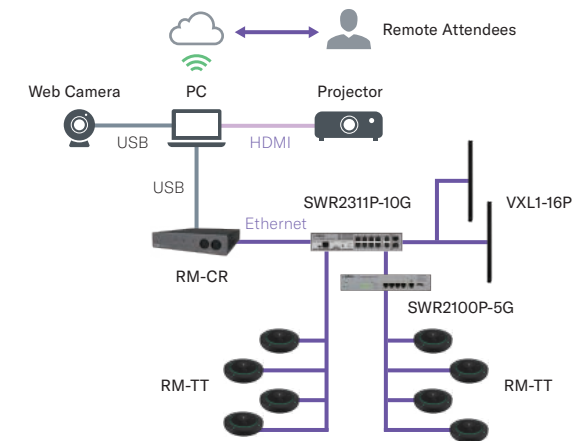

### Configuration Devices

ADECIA TABLETOP SOLUTION / SWR2100P-5G P39-40

Number of  
Participants

10-20

## MID-SIZED CONFERENCE ROOM



For panel discussions with multiple presenters, connecting an analog mixer in front of the YVC-1000 allows simultaneous use of multiple wireless microphones. The presenters' voices can also be amplified, contributing to high-quality presentations, including remote meetings. Students' voices are picked up using the YVC-1000's microphone extensions and transmitted to remote participants.

### Features

- Equipped with Human Voice Activity Detection (HVAD), Yamaha's unique intelligent voice signal processing technology that distinguishes human voices from ambient noise.
- Noise Reduction cuts down on noise and transmits voices only.
- Adaptive Echo Canceller for two-way conversations without the sound breaking up.
- Automatic Gain Control adjusts the volume of human voices from both near and far from the microphone.
- Automatic Room EQ adjusts the speaker playback sound for ease of hearing.
- Zoom and Barco certified.

### System Configuration

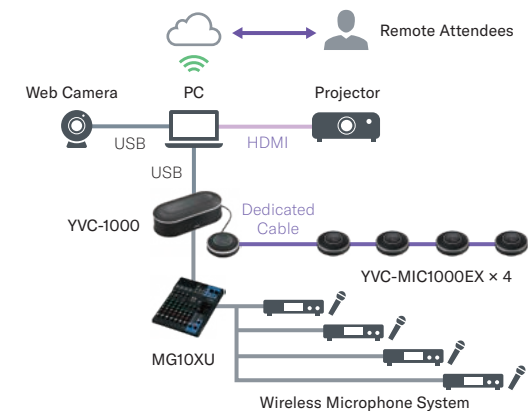

### Configuration Devices

YVC-1000 / YVC-MIC1000EX / MG10XU P38,41

Number of  
Participants

About **12**

## MID-SIZED CONFERENCE ROOM



The ADECIA Ceiling Solution is perfect for use when conference room layout is changed frequently. The ceiling array microphone automatically tracks the person speaking to clearly pick up voices even if the layout of the room is changed.

### Features

- Equipped with Multi-beam Tracking that uses four beams to follow multiple people speaking simultaneously without missing a sound.
- Human Voice Activity Detection (HVAD) achieves pleasant calling with high-precision voice processing.
- Adaptive Echo Canceller with high echo cancellation performance.
- Noise Reduction greatly reduces ambient and background noise.
- Automatic Gain Control for comfortable conversations and easy-to-hear voices.
- Line array speakers with a slim design only 54 millimeters wide and with high sound quality.
- Microsoft Teams certified (RM-CG, RM-CR).

### System Configuration

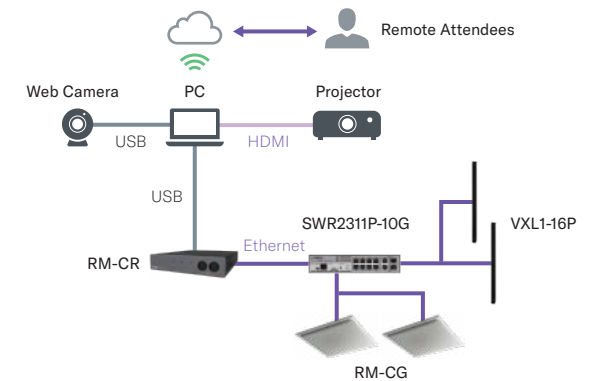

### Configuration Devices

**ADECIA CEILING SOLUTION** P39-40

Number of  
Participants

10-20

## MID-SIZED CLASSROOM



Hands-free amplification is achieved by capturing the instructor's voice with a ceiling microphone. Students' speech is picked up by wireless microphones, and ceiling speakers provide clear and uniform audio, even at remote locations.

### Features

- Equipped with Multi-beam Tracking that uses four beams to follow multiple people speaking simultaneously without missing a sound.
- Human Voice Activity Detection (HVAD) achieves pleasant calling with high-precision voice processing.
- Adaptive Echo Canceller with high echo cancellation performance.
- Noise Reduction greatly reduces ambient and background noise.
- Automatic Gain Control for comfortable conversations and easy-to-hear voices.
- The matrix processor packs a variety of functions into a compact housing.

Please also refer to this document for detailed settings and precautions regarding this system.

<https://download.yamaha.com/files/tcm:39-1594458>

### System Configuration

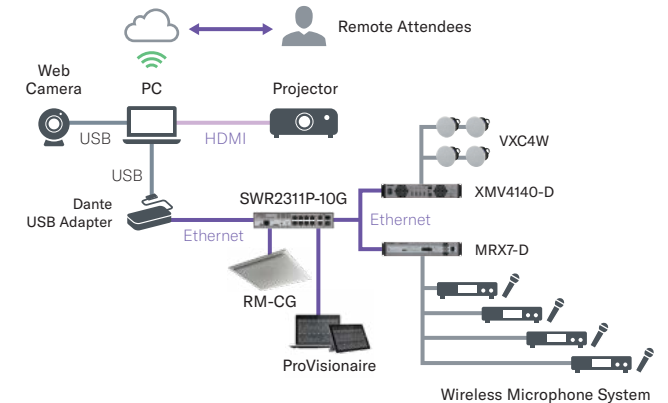

### Configuration Devices

RM-CG / SWR2311P-10G / MRX7-D / XMV410-D / VXC4W /

ProVisionaire P39-42

Number of  
Participants

About **100**

## LECTURE ROOM



Dante-enabled digital mixer to flexibly support large-scale lecture systems. The vertical connection of line array speakers saves space and accurately covers a wide area.

### Features

- Equipped with Dugan Automixer.
- Equipped with Gain Finder to support gain adjustment.
- Equipped with 1-knob COMP and 1-knob EQ for optimal sound with a single knob.
- Line array speakers with a slim design only 54 millimeters wide and with high sound quality.
- Speakers can be connected vertically or horizontally to achieve a coverage pattern tailored to their use.

### System Configuration

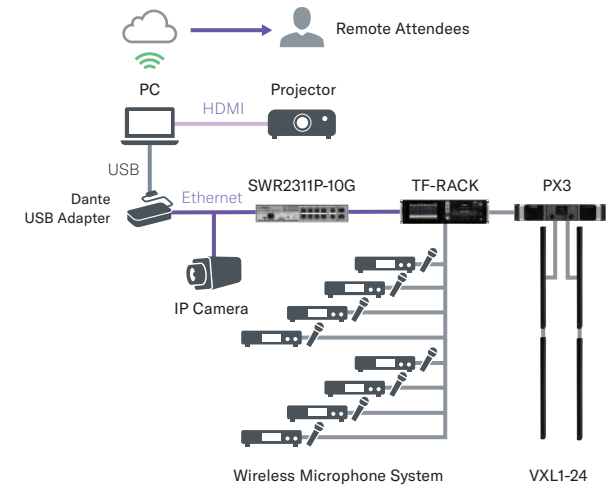

### Configuration Devices

**SWR2311P-10G / TF-RACK / PX3 / VXL1-24** P40-42

Number of  
Participants

About **300**

## AUDITORIUM

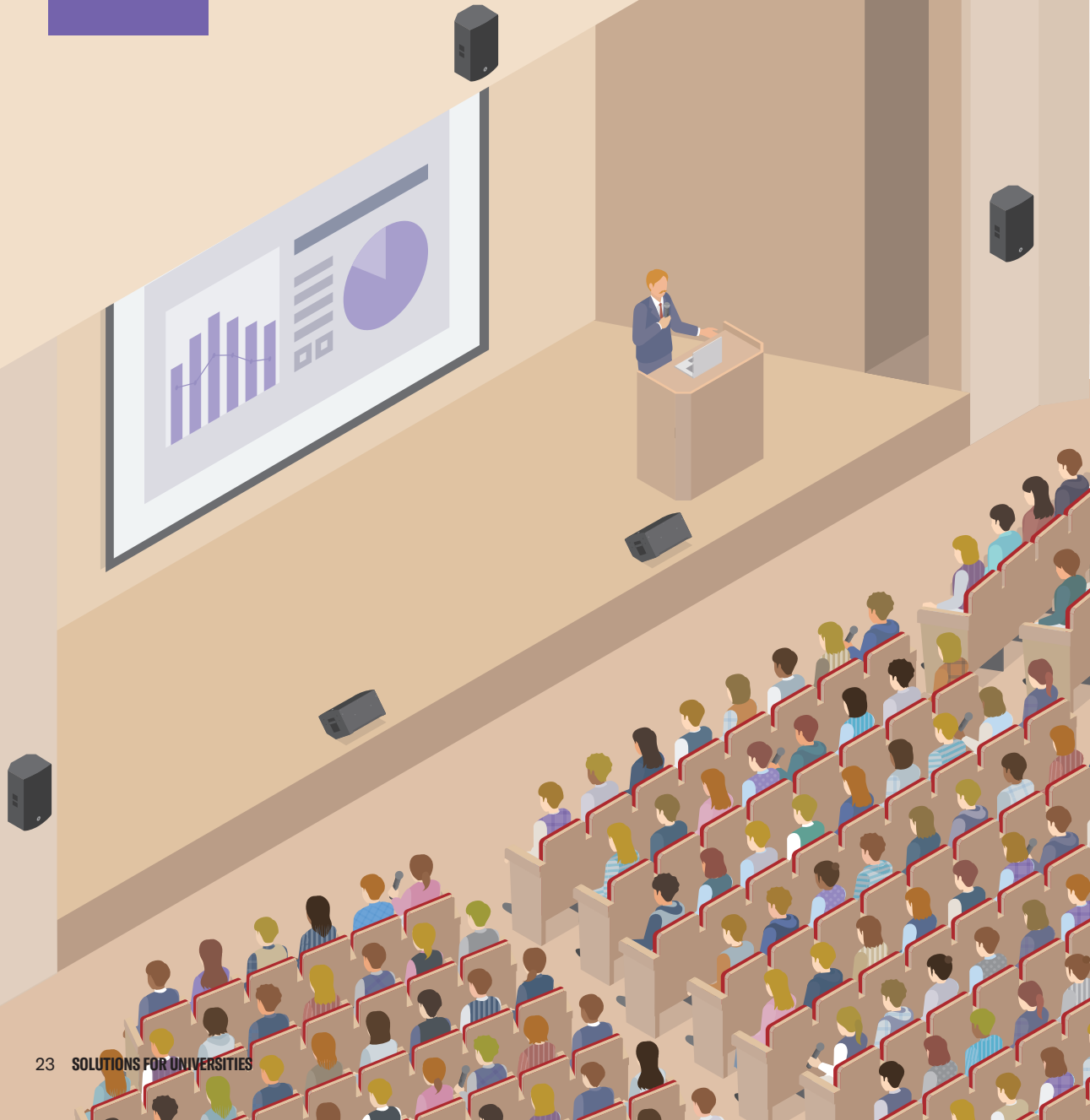

Constructing a system centered on a Dante-compatible mixer also allows flexible support for venues such as large lecture rooms. The CZR series offers both high sound quality and powerful output, and allows horn rotation for optimal coverage whether installed vertically or horizontally. The PC-D series comes equipped with CZR series presets for easy configuration of ideal DSP settings.

### Features

- All-in-one digital mixer with Dante for easy expansion to suit the purpose of use.
- Equipped with Dugan Automixer.
- Dante-enabled power amplifier.
- Fixed-directional horn mounted on the compression driver provides more ideal and stable coverage. Rotatability provides proper coverage regardless of installation method.
- The DSP functions and presets equipping the PC-D series allow optimal speaker tuning.

### System Configuration

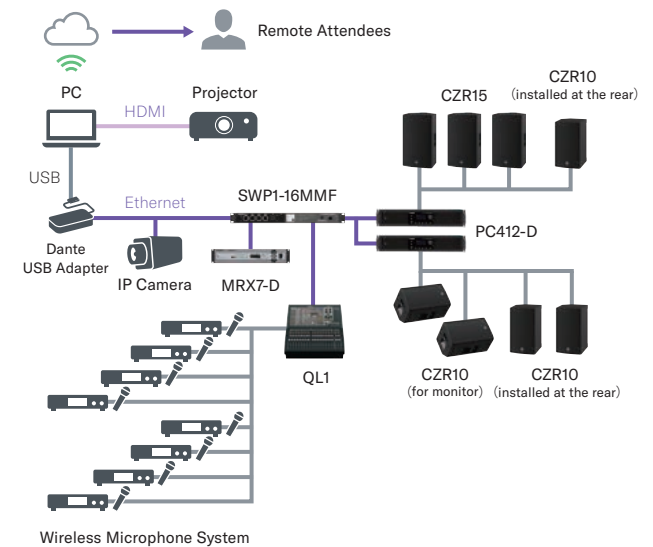

### Configuration Devices

MRX7-D / SWP1-16MMF / PC412-D / QL1 / CZR15 / CZR10 **P40-42**





SOLUTIONS  
FOR **BUSINESSES**

Number of  
Participants

1-4

## MEETING SPACE OR HOME



Meeting Space



Home

The YVC-200's abundant voice processing technologies enable pleasant communication even in a remote setting, and the small housing with built-in battery is ideal for carrying.

### Features

- Adaptive Echo Canceller for stress-free two-way conversations.
- Noise Reduction gets rid of noise and delivers only human voices to participants on the other end.
- Automatic Gain Control automatically adjusts volume according to the distance of the person speaking.
- Rechargeable battery for up to 10 hours of continuous conversation.

### System Configuration

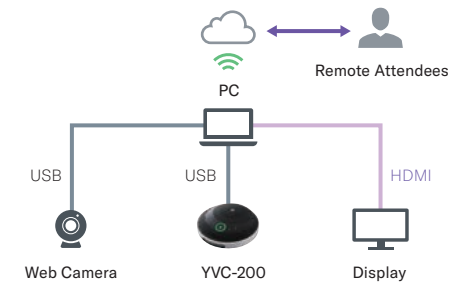

### Configuration Devices

YVC-200 [P38](#)

Number of  
Participants

1-4

## OPEN SPACES



The CS-500's unique SoundCap Eye feature tracks the position and speech of participants to properly pick up sound. Natural teleconferencing can be achieved even in open spaces and other noisy environments.

### Features

- Face Focus Beamforming tracks participants' faces analyzed by AI, picks up sound, and frames the video.
- Self-Silence separates human voices from noise, and automatically mutes microphones when the participants are not speaking.
- Self-Volume Balancer constantly adjusts the speaker to the appropriate level based on the level of ambient noise.
- Microphones arranged in a hexagonal array form a three-dimensional microphone beam to pick up sound clearly and accurately.
- Recognizing people causes the display to automatically start up and show the on-screen user guide.

### System Configuration

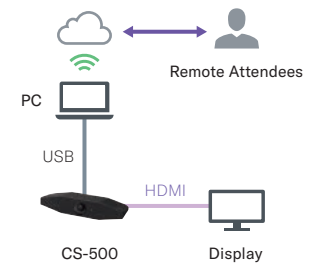

### Configuration Devices

CS-500 P38

Number of  
Participants

About **4**

## MEETING SPACE



The YVC-330's unique SoundCap allows natural remote communication even in open meeting spaces.

### Features

- SoundCap consists of three functions to achieve clear and natural conversations just like a quiet conference room even in noisy open spaces with no surrounding walls, enabling natural remote communication with multiple people.
- **Far Field Noise Reduction (FFNR):** Captures the voices of meeting participants near the main unit while suppressing unwanted ambient noise for clear voice delivery.
- **Self-Silence:** Recognizes whether someone is speaking and automatically mutes and unmutes the microphone, allowing participants on the other end to focus on the meeting without being disturbed by noise.
- **Self-Volume Balancer:** Constantly adjusts the speaker volume to the right volume based on the amount of ambient noise.

### System Configuration

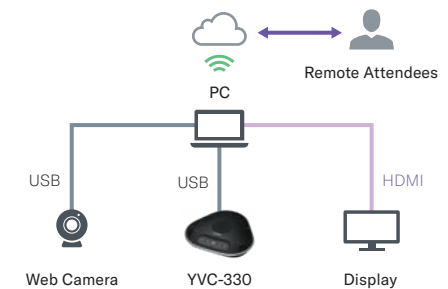

### Configuration Devices

YVC-330 **P38**

Number of  
Participants

About **4**

## Huddle Room



The perfect plug-and-play solution for meeting in the huddle room. The microphone and speaker come as a single unit for easy carrying. SoundCap technology provides clear audio even in noisy environments.

### Features

- Equipped with Human Voice Activity Detection (HVAD), Yamaha's unique intelligent voice signal processing technology that distinguishes human voices from ambient noise.
- Adaptive Echo Canceller for two-way conversations without the sound breaking up.
- Automatic Gain Control adjusts the volume of human voices from both near and far from the microphone.
- USB connection without the need for a dedicated driver.
- Zoom certified.

### System Configuration

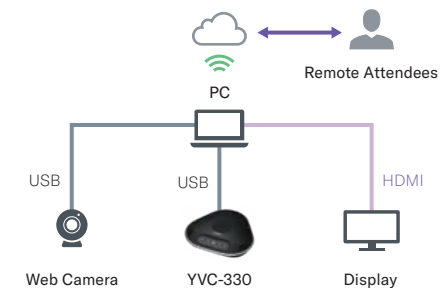

### Configuration Devices

**YVC-330** [P38](#)

Number of  
Participants

6-10

## SMALL CONFERENCE ROOM



Connecting two YVC-330 enables a flexible response to increases in conference room sizes and participant numbers.

### Features

- Able to connect two YVC-330 and use to accommodate the size of the conference room and the number of participants.
- Adaptive Echo Canceller for stress-free two-way conversations.
- Automatic Tracking follows the person speaking.
- Automatic Gain Control automatically adjusts volume according to the distance of the person speaking from the microphone.
- Dereverberation suppresses echo in spaces where voices resonate easily, and delivers clear audio to the other end of the call.

### System Configuration

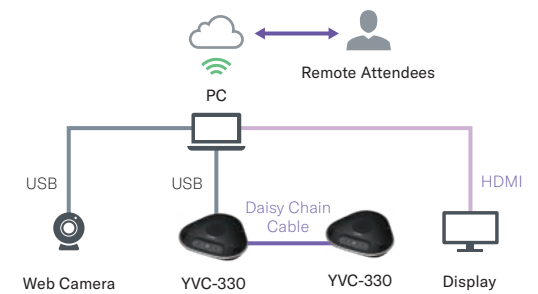

### Configuration Devices

YVC-330 [P38](#)

Number of  
Participants

6-10

## SMALL CONFERENCE ROOM



The CS-800's unique SoundCap Eye feature tracks the position and speech of participants to properly capture sound. Natural teleconferencing can be achieved even in open spaces and other noisy environments.

### Features

- Face Focus Beamforming tracks participants' faces analyzed by AI, picks up sound, and frames the video.
- Self-Silence separates human voices from noise, and automatically mutes microphones when the participants are not speaking.
- Self-Volume Balancer constantly adjusts the speaker to the appropriate level based on the level of ambient noise.
- Microphones arranged in a hexagonal array form a three-dimensional microphone beam to pick up sound clearly and accurately.
- Recognizing people causes the display to automatically start up and show the on-screen user guide.

### System Configuration

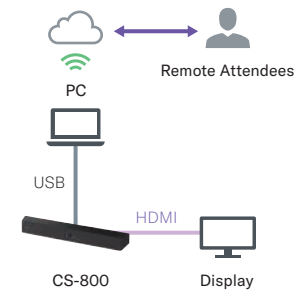

### Configuration Devices

CS-800 P38

Number of  
Participants

8-16

## SMALL/MID-SIZED CONFERENCE ROOM



The ADECIA Ceiling Solution, which automatically follows the person speaking, eliminates the preparation work required to accommodate layout changes or increased/decreased numbers of people, so that meetings can start smoothly.

### Features

- Multi-beam Tracking can detect the direction of the person speaking and also pick up simultaneous speech without missing a sound. There is no need to adjust the pickup range.
- Adaptive Echo Canceller for stress-free two-way conversations.
- Noise Reduction gets rid of noise and delivers only human voices to participants on the other end.
- Dereverberation suppresses echo in spaces where voices easily resonate, and delivers clear audio to the other end of the call.
- Automatic Gain Control automatically adjusts volume according to the distance of the person speaking from the microphone.

### System Configuration

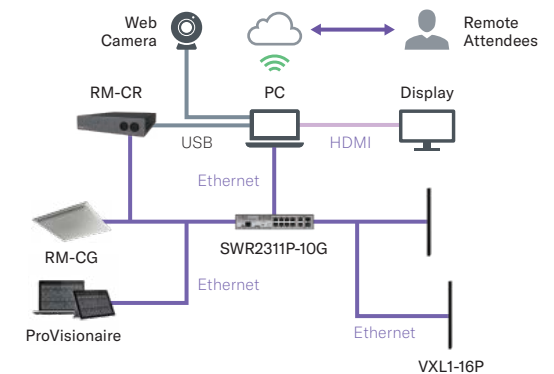

### Configuration Devices

ADECIA CEILING SOLUTION / ProVisionaire P39-40,42



Number of  
Participants

10-20

## MID-SIZED CONFERENCE ROOM



The YVC-1000 is equipped with abundant audio processing technology that automatically optimizes sound quality, contributes to comfortable teleconferencing, and allows microphone extensions to optimally match the layout and number of people.

### Features

- Automatic Room EQ optimizes the acoustic settings according to the sound environment within the room.
- Adaptive Echo Canceller for stress-free two-way conversations.
- Automatic Tracking follows the person speaking.
- Automatic Gain Control automatically adjusts volume according to the distance of the person speaking from the microphone.
- Up to four extension microphones (for a total of five including the supplied microphone) can be added to accommodate the number of participants.

### System Configuration

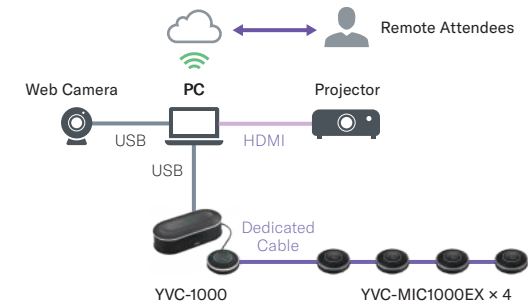

### Configuration Devices

YVC-1000 / YVC-MIC1000EX P38

Number of  
Participants

10-20

## MID-SIZED CONFERENCE ROOM



The external input terminal of the YVC-1000 means that it can even be used in seminars or panel discussions with multiple presenters. The voices of participants can also be picked up by YVC-1000 microphone extensions.

### Features

- The YVC-1000 has a wide variety of input and output terminals, allowing flexible system expansion according to room size, layout, and number of participants.
- Adaptive Echo Canceller for stress-free two-way conversations.
- Automatic Tracking follows the person speaking.
- Automatic Gain Control automatically adjusts volume according to the distance of the person speaking from the microphone.
- Dereverberation suppresses echo in spaces where voices easily resonate, and delivers clear audio to the other end of the call.

### System Configuration

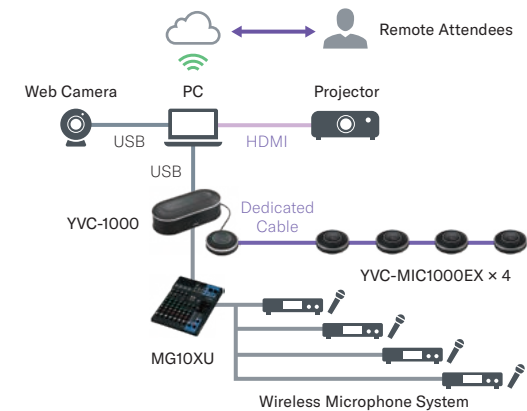

### Configuration Devices

YVC-1000 / YVC-MIC1000EX / MG10XU P38,41

Number of  
Participants

10-20

## MID-SIZED CONFERENCE ROOM



The external input terminal of the YVC-1000 allows it to be used in long rooms. External speakers deliver clear audio throughout the room.

### Features

- The YVC-1000 has a wide variety of input and output terminals, allowing flexible system expansion according to room size, layout, and number of participants.
- Adaptive Echo Canceller for stress-free two-way conversations.
- Automatic Tracking follows the person speaking.
- Automatic Gain Control automatically adjusts volume according to the distance of the person speaking from the microphone.
- Dereverberation suppresses echo in spaces where voices easily resonate, and delivers clear audio to the other end of the call.

### System Configuration

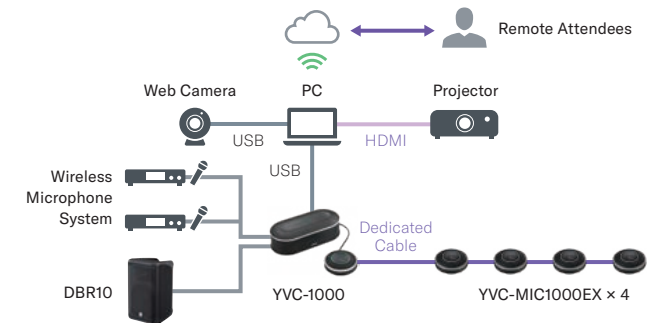

### Configuration Devices

YVC-1000 / YVC-MIC1000EX / DBR10 [P38,42](#)

Number of Participants

10-20

## MID-SIZED CONFERENCE ROOM



The ADECIA Tabletop Solution makes it easy to position microphones according to the number of participants and seats.

### Features

- Auto Voice Tracking automatically detects the direction of the person speaking and effectively picks up sounds. Directivity can also be selected according to the installation environment.
- Adaptive Echo Canceller for stress-free two-way conversations.
- Noise Reduction gets rid of noise and delivers only human voices to participants on the other end.
- Dereverberation suppresses echo in spaces where voices easily resonate, and delivers clear audio to the other end of the call.
- Auto Gain Control automatically adjusts volume according to the distance of the person speaking from the microphone.

### System Configuration

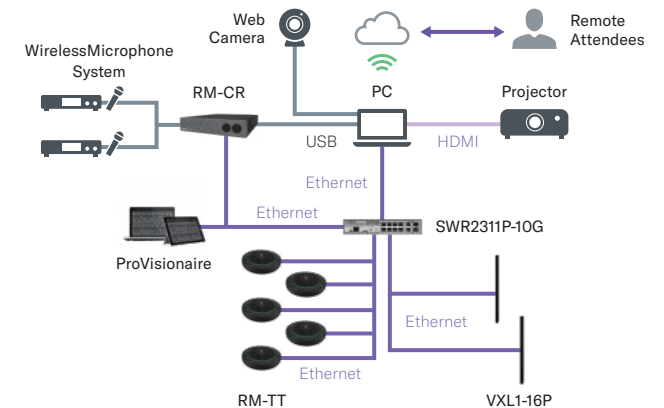

### Configuration Devices

ADECIA TABLETOP SOLUTION / ProVisionaire P39-40,42

Number of  
Participants

10-20

## MID-SIZED CONFERENCE ROOM



The ADECIA Ceiling Solution is perfect for use when conference room layout is changed frequently. The ceiling array microphone automatically tracks the person speaking to clearly pick up voices even if the layout of the room is changed.

### Features

- Equipped with Multi-beam Tracking that uses four beams to follow multiple people speaking simultaneously without missing a sound.
- Human Voice Activity Detection (HVAD) achieves pleasant calling with high-precision voice processing.
- Adaptive Echo Canceller with high echo cancellation performance.
- Noise Reduction greatly reduces ambient and background noise.
- Automatic Gain Control for comfortable conversations and easy-to-hear voices.

### System Configuration

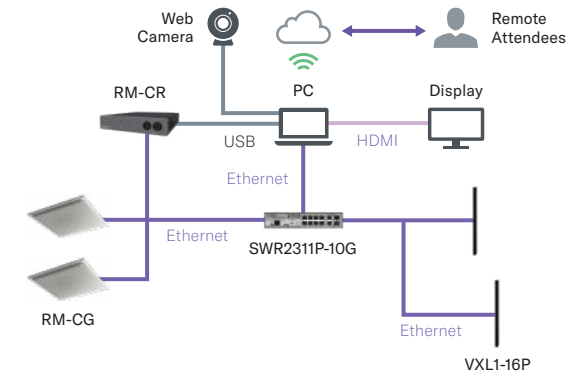

### Configuration Devices

ADECIA CEILING SOLUTION P39-40

Number of  
Participants

**10-20**  
(per room)

## MID-SIZED CONFERENCE ROOM (WITH PARTITIONS)



Even when dividing or merging multiple meeting rooms, the ADECIA Ceiling Solution automatically follows the person speaking, accommodating changes in room size and layout and allowing clear audio capture.

### Features

- Multi-beam Tracking detects the direction of the person speaking and can also pick up simultaneous speech without missing a sound. There is no need to adjust the pickup range.
- Adaptive Echo Canceller for stress-free two-way conversations.
- Dereverberation suppresses echo in spaces where voices easily resonate, and delivers clear audio to the other end of the call.
- Automatic Gain Control automatically adjusts volume according to the distance of the person speaking from the microphone.
- The touch panel controller can be arranged to suit the environment.

### System Configuration

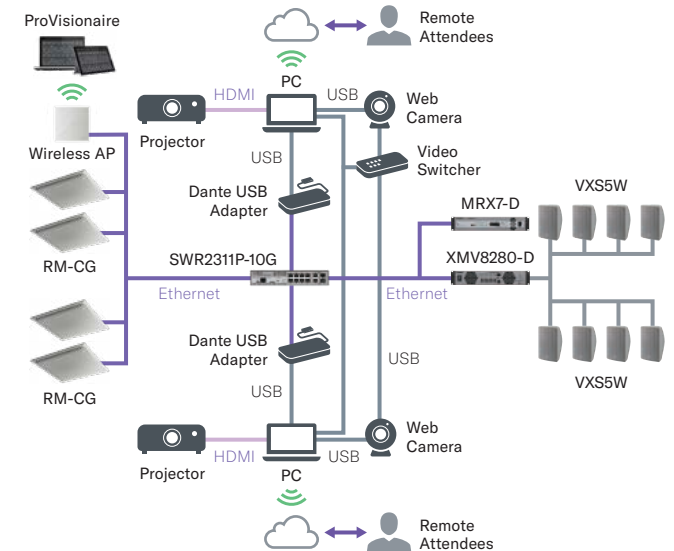

### Configuration Devices

**RM-CG / SWR2311P-10G / MRX7-D / XMV8280-D / VXS5W /**

**ProVisionaire** P39-42

## PRODUCT INFORMATION

### CS SERIES



Video Sound Bar

#### CS-800



Video Collaboration System

#### CS-500

- SoundCap Eye™ enables open space remote communication by “finding” and “capturing” voice clearly
- Smart Framing feature automatically adjusts camera frame for smooth communication
- Easy Launch designed for everyone to communicate smartly, quickly and easily

### YVC SERIES



Unified Communications Microphone & Speaker System

#### YVC-1000

- Can be connected to a handheld microphone for use in remote seminars



YVC-1000 Extension Microphone

#### YVC-MIC1000EX

- The YVC-1000 comes with a single microphone and can be connected to up to four extension microphones (for a total of five microphones)
- Can be used in multiple ways to suit the size and layout of a room



Unified Communications Speakerphone

#### YVC-330

- Equipped with two modes for use in noisy open spaces or quiet conference rooms

\*The YCBL-DC3M connecting cable is required to connect two units



YVC-330 Daisy Chain Cable

#### YCBL-DC3M



Unified Communications Speakerphone

#### YVC-200

- Equipped with a battery so it can be used in meeting corners, at home, or on the go

ADECIA

MICROPHONE SYSTEM

ADECIA CEILING SOLUTION

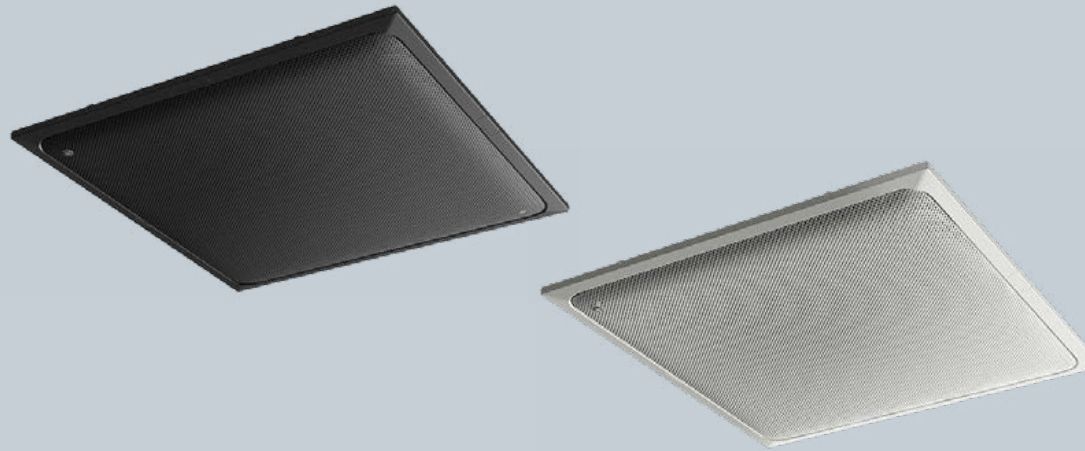

Ceiling Array Microphone

**RM-CG**

- A ceiling array microphone equipped with unique audio signal processing technology that enables high-quality communication

ADECIA TABLETOP SOLUTION



Tabletop Array Microphone

**RM-TT**

- Tabletop array microphones provide a comfortable sound environment with no configuration needed



## PROCESSOR / SWITCH



Remote Conference Processor

### RM-CR

- Signal processor at the heart of the ADECIA



Intelligent L2 Network Switch with PoE

### SWR2311P-10G

- An intelligent L2 switch that has the optimal functions for Dante and can supply PoE+ to up to 8 connected devices

## SPEAKER SYSTEM



Dante PoE Powered Speaker System

### VXL1W-16P/VXL1B-16P

- A Dante powered speaker by PoE power supply.

## EXTENSION EQUIPMENTS



Signal Processor

### MRX7-D



L2 Switch

### SWP1-16MMF



L2 Switch

### SWR2310-10G



Simple L2 Network Switch with PoE

### SWR2100P-5G

## PRODUCT INFORMATION

## EXTENSION EQUIPMENTS



Power Amplifier  
**XMV8280-D**



Power Amplifier  
**PC412-D**



Mixing Console  
**MG10XU**



Power Amplifier  
**XMV4140-D**



Digital Mixing Console  
**QL1**

Portable PA System  
**STAGEPAS 1K mkII**



Power Amplifier  
**PX3**



Digital Mixer  
**TF-RACK**



PA System

## STAGEPAS 400BT



Powered Loudspeaker

## DBR10



Surface Mount Speaker

## VXS5/VXS5W



Loudspeaker

## CZR15



Loudspeaker

## CZR10



Line Array Speaker

## VXL1B-24/VXL1W-24



Ceiling Speaker

## VXC4/VXC4W



Customizable Control Panel

## ProVisionaire





YAMAHA CORPORATION

© 2023 Yamaha Corporation. All rights reserved.  
Product features and specifications are subject to change without notice by Yamaha.  
All other product and company names and logos that appear in this leaflet are trademarks or registered trademarks of their respective owners.

BR-REMOTE-COM-SOLUTION-202303-EN