



# DTX

drums

Drum Trigger Module

# DTX-PROX

## Owner's Manual

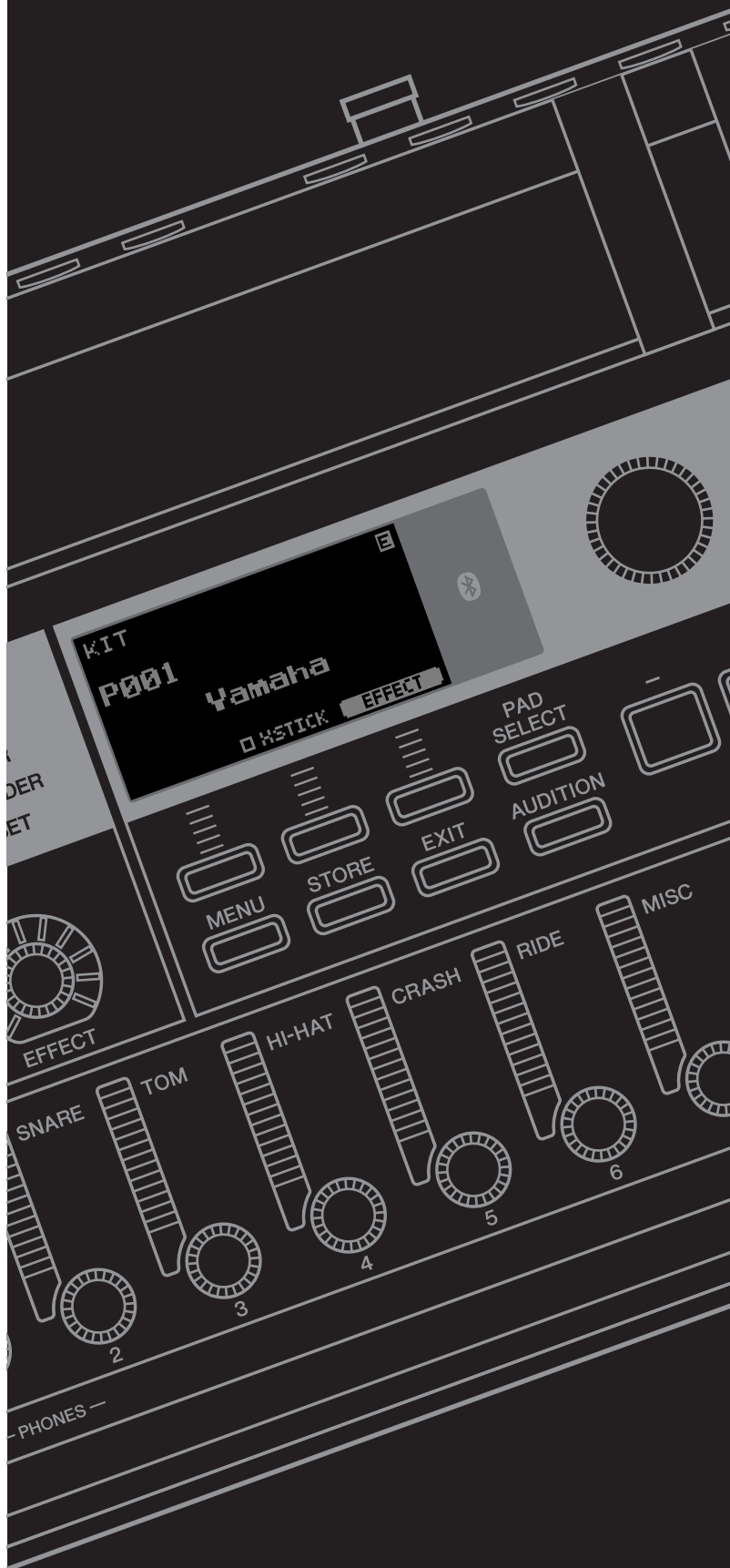

**Features of the  
DTX-PROX**

**page 8**

**Contents**

**page 9**

**Specifications**

**page 60**

# SPECIAL MESSAGE SECTION

This product utilizes batteries or an external power supply (adapter). DO NOT connect this product to any power supply or adapter other than one described in the manual, on the name plate, or specifically recommended by Yamaha.

**WARNING:** Do not place this product in a position where anyone could walk on, trip over, or roll anything over power or connecting cords of any kind. The use of an extension cord is not recommended! If you must use an extension cord, the minimum wire size for a 25' cord (or less) is 18 AWG. NOTE: The smaller the AWG number, the larger the current handling capacity. For longer extension cords, consult a local electrician.

This product should be used only with the components supplied or; a cart, rack, or stand that is recommended by Yamaha. If a cart, etc., is used, please observe all safety markings and instructions that accompany the accessory product.

## **SPECIFICATIONS SUBJECT TO CHANGE:**

The information contained in this manual is believed to be correct at the time of printing. However, Yamaha reserves the right to change or modify any of the specifications without notice or obligation to update existing units.

This product, either alone or in combination with an amplifier and headphones or speaker/s, may be capable of producing sound levels that could cause permanent hearing loss. DO NOT operate for long periods of time at a high volume level or at a level that is uncomfortable. If you experience any hearing loss or ringing in the ears, you should consult an audiologist.

**IMPORTANT:** The louder the sound, the shorter the time period before damage occurs.

## **NOTICE:**

Service charges incurred due to a lack of knowledge relating to how a function or effect works (when the unit is operating as designed) are not covered by the manufacturer's warranty, and are therefore the owners responsibility. Please study this manual carefully and consult your dealer before requesting service.

## **ENVIRONMENTAL ISSUES:**

Yamaha strives to produce products that are both user safe and environmentally friendly. We sincerely believe that our products and the production methods used to produce them, meet these goals. In keeping with both the letter and the spirit of the law, we want you to be aware of the following:

## **Battery Notice:**

This product MAY contain a small non-rechargeable battery which (if applicable) is soldered in place. The average life span of this type of battery is approximately five years. When replacement becomes necessary, contact a qualified service representative to perform the replacement.

This product may also use "household" type batteries. Some of these may be rechargeable. Make sure that the battery being charged is a rechargeable type and that the charger is intended for the battery being charged.

When installing batteries, never mix old batteries with new ones, and never mix different types of batteries. Batteries MUST be installed correctly. Mismatches or incorrect installation may result in overheating and battery case rupture.

## **Warning:**

Do not attempt to disassemble, or incinerate any battery. Keep all batteries away from children. Dispose of used batteries promptly and as regulated by the laws in your area. Note: Check with any retailer of household type batteries in your area for battery disposal information.

## **Disposal Notice:**

Should this product become damaged beyond repair, or for some reason its useful life is considered to be at an end, please observe all local, state, and federal regulations that relate to the disposal of products that contain lead, batteries, plastics, etc. If your dealer is unable to assist you, please contact Yamaha directly.

## **NAME PLATE LOCATION:**

The name plate is located on the bottom of the product. The model number, serial number, power requirements, etc., are located on this plate. You should record the model number, serial number, and the date of purchase in the spaces provided below and retain this manual as a permanent record of your purchase.

Model \_\_\_\_\_

Serial No. \_\_\_\_\_

Purchase Date \_\_\_\_\_

# PLEASE KEEP THIS MANUAL

92-BP (bottom)

## **COMPLIANCE INFORMATION STATEMENT (Supplier's declaration of conformity procedure)**

Responsible Party : Yamaha Corporation of America  
Address : 6600 Orangethorpe Ave., Buena Park, Calif. 90620  
Telephone : 714-522-9011  
Type of Equipment : Drum Trigger Module  
Model Name : DTX-PROX

This device complies with Part 15 of the FCC Rules.

Operation is subject to the following two conditions:

- 1) this device may not cause harmful interference, and
- 2) this device must accept any interference received including interference that may cause undesired operation.

\* This applies only to products distributed by Yamaha Corporation of America.

(FCC SD0C)

**CAN ICES-3 (B)/NMB-3(B)**

(can\_b\_02)

# FCC INFORMATION (U.S.A.)

## 1. IMPORTANT NOTICE: DO NOT MODIFY THIS UNIT!

This product, when installed as indicated in the instructions contained in this manual, meets FCC requirements. Modifications not expressly approved by Yamaha may void your authority, granted by the FCC, to use the product.

## 2. IMPORTANT:

When connecting this product to accessories and/or another product use only high quality shielded cables. Cable/s supplied with this product MUST be used. Follow all installation instructions. Failure to follow instructions could void your FCC authorization to use this product in the USA.

## 3. NOTE:

This product has been tested and found to comply with the requirements listed in FCC Regulations, Part 15 for Class "B" digital devices. Compliance with these requirements provides a reasonable level of assurance that your use of this product in a residential environment will not result in harmful interference with other electronic devices. This equipment generates/uses radio frequencies and, if not installed and used according to the instructions found in the users manual, may cause interference harmful to the operation of other electronic devices. Compliance with FCC regulations does

not guarantee that interference will not occur in all installations. If this product is found to be the source of interference, which can be determined by turning the unit "OFF" and "ON", please try to eliminate the problem by using one of the following measures:

Relocate either this product or the device that is being affected by the interference.

Utilize power outlets that are on different branch (circuit breaker or fuse) circuits or install AC line filter/s.

In the case of radio or TV interference, relocate/reorient the antenna. If the antenna lead-in is 300 ohm ribbon lead, change the lead-in to co-axial type cable.

If these corrective measures do not produce satisfactory results, please contact the local retailer authorized to distribute this type of product. If you can not locate the appropriate retailer, please contact Yamaha Corporation of America, Electronic Service Division, 6600 Orangethorpe Ave, Buena Park, CA90620

The above statements apply ONLY to those products distributed by Yamaha Corporation of America or its subsidiaries.

\* This applies only to products distributed by Yamaha Corporation of America.

(class B)

# For AC adaptor

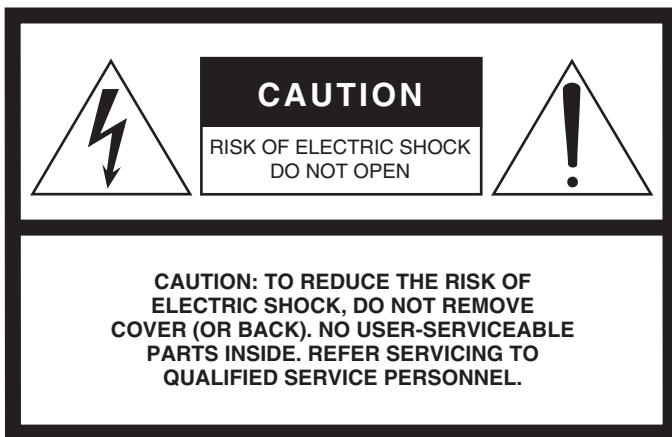

## Explanation of Graphical Symbols

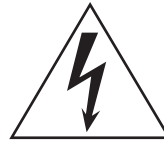

The lightning flash with arrowhead symbol within an equilateral triangle is intended to alert the user to the presence of uninsulated “dangerous voltage” within the product’s enclosure that may be of sufficient magnitude to constitute a risk of electric shock to persons.



The exclamation point within an equilateral triangle is intended to alert the user to the presence of important operating and maintenance (servicing) instructions in the literature accompanying the product.

The above warning is located on the bottom of the unit.

## IMPORTANT SAFETY INSTRUCTIONS

- 1 Read these instructions.
- 2 Keep these instructions.
- 3 Heed all warnings.
- 4 Follow all instructions.
- 5 Do not use this apparatus near water.
- 6 Clean only with dry cloth.
- 7 Do not block any ventilation openings. Install in accordance with the manufacturer’s instructions.
- 8 Do not install near any heat sources such as radiators, heat registers, stoves, or other apparatus (including amplifiers) that produce heat.
- 9 Do not defeat the safety purpose of the polarized or grounding-type plug. A polarized plug has two blades with one wider than the other. A grounding type plug has two blades and a third grounding prong. The wide blade or the third prong are provided for your safety. If the provided plug does not fit into your outlet, consult an electrician for replacement of the obsolete outlet.
- 10 Protect the power cord from being walked on or pinched particularly at plugs, convenience receptacles, and the point where they exit from the apparatus.
- 11 Only use attachments/accessories specified by the manufacturer.
- 12 Use only with the cart, stand, tripod, bracket, or table specified by the manufacturer, or sold with the apparatus. When a cart is used, use caution when moving the cart/apparatus combination to avoid injury from tip-over.
- 13 Unplug this apparatus during lightning storms or when unused for long periods of time.
- 14 Refer all servicing to qualified service personnel. Servicing is required when the apparatus has been damaged in any way, such as power-supply cord or plug is damaged, liquid has been spilled or objects have fallen into the apparatus, the apparatus has been exposed to rain or moisture, does not operate normally, or has been dropped



### WARNING

TO REDUCE THE RISK OF FIRE OR ELECTRIC SHOCK, DO NOT EXPOSE THIS APPARATUS TO RAIN OR MOISTURE.

(UL60065\_03)

The model number, serial number, power requirements, etc., may be found on or near the name plate, which is at the bottom of the unit.  
You should note this serial number in the space provided below and retain this manual as a permanent record of your purchase to aid identification in the event of theft.

**Model No.** \_\_\_\_\_

**Serial No.** \_\_\_\_\_

(bottom\_en\_01)

### **Information for users on collection and disposal of old equipment:**



This symbol on the products, packaging, and/or accompanying documents means that used electrical and electronic products should not be mixed with general household waste.

For proper treatment, recovery and recycling of old products, please take them to applicable collection points, in accordance with your national legislation.

By disposing of these products correctly, you will help to save valuable resources and prevent any potential negative effects on human health and the environment which could otherwise arise from inappropriate waste handling.

For more information about collection and recycling of old products, please contact your local municipality, your waste disposal service or the point of sale where you purchased the items.

#### **For business users in the European Union:**

If you wish to discard electrical and electronic equipment, please contact your dealer or supplier for further information.

#### **Information on Disposal in other Countries outside the European Union:**

This symbol is only valid in the European Union. If you wish to discard these items, please contact your local authorities or dealer and ask for the correct method of disposal.

(weee\_eu\_en\_02)

# PRECAUTIONS

## PLEASE READ CAREFULLY BEFORE PROCEEDING

Please keep this manual in a safe and handy place for future reference.

## For the AC adaptor

### **WARNING**

- This AC adaptor is designed for use with only Yamaha electronic instruments. Do not use for any other purpose.
- Indoor use only. Do not use in any wet environments.

### **CAUTION**

- When setting up, make sure that the AC outlet is easily accessible. If some trouble or malfunction occurs, immediately turn off the power switch of the instrument and disconnect the AC adaptor from the outlet. When the AC adaptor is connected to the AC outlet, keep in mind that electricity is flowing at the minimum level, even if the power switch is turned off. When you are not using the instrument for a long time, make sure to unplug the power cord from the wall AC outlet.

## For DTX-PROX

### **WARNING**

Always follow the basic precautions listed below to avoid the possibility of serious injury or even death from electrical shock, short-circuiting, damages, fire or other hazards. These precautions include, but are not limited to, the following:

#### Power supply/AC adaptor

- Do not place the power cord near heat sources such as heaters or radiators. Also, do not excessively bend or otherwise damage the cord, or place heavy objects on it.
- Only use the voltage specified as correct for the instrument. The required voltage is printed on the name plate of the instrument.
- Use the specified adaptor (page 60) only. Using the wrong adaptor can result in damage to the instrument or overheating.
- Check the electric plug periodically and remove any dirt or dust which may have accumulated on it.

#### Do not open

- This instrument contains no user-serviceable parts. Do not open the instrument or attempt to disassemble or modify the internal components in any way. If it should appear to be malfunctioning, discontinue use immediately and have it inspected by qualified Yamaha service personnel.

#### Water warning

- Do not expose the instrument to rain, use it near water or in damp or wet conditions, or place on it any containers (such as vases, bottles or glasses) containing liquids which might spill into any openings. If any liquid such as water seeps into the instrument, turn off the power immediately and unplug the power cord from the AC outlet. Then have the instrument inspected by qualified Yamaha service personnel.
- Never insert or remove an electric plug with wet hands.

#### Fire warning

- Do not put burning items, such as candles, on the unit. A burning item may fall over and cause a fire.

#### Influences on electro-medical devices

- Radio waves or magnetism may affect electro-medical devices.
  - Do not use this product near medical devices or inside areas in which the use of radio waves is restricted.
  - Do not use this product within 15cm (6 in.) of persons with a heart pacemaker or defibrillator implant.

#### If you notice any abnormality

- When one of the following problems occur, immediately turn off the power switch and disconnect the electric plug from the outlet. Then have the device inspected by Yamaha service personnel.
  - The power cord or plug becomes frayed or damaged.
  - It emits unusual smells or smoke.
  - Some object has been dropped into the instrument.
  - There is a sudden loss of sound during use of the instrument.
  - If any cracks or breakages exist on the instrument.

## **CAUTION**

Always follow the basic precautions listed below to avoid the possibility of physical injury to you or others, or damage to the instrument or other property. These precautions include, but are not limited to, the following:

### **Power supply/AC adaptor**

- Do not connect the instrument to an electrical outlet using a multiple-connector. Doing so can result in lower sound quality, or possibly cause overheating in the outlet.
- When removing the electric plug from the instrument or an outlet, always hold the plug itself and not the cord. Pulling by the cord can damage it.
- Remove the electric plug from the outlet when the instrument is not to be used for extended periods of time, or during electrical storms.

### **Assembly**

- Assemble the instrument in the proper sequence by following the assembly instructions in this manual. Also, make sure to tighten the bolts regularly. Failure to do so might result in damage to the instrument or even injury.

### **Location**

- Do not place the instrument in an unstable position where it might accidentally fall over.
- Before moving the instrument, remove all connected cables, to prevent damage to the cables or injury to anyone who might trip over them.
- When setting up the product, make sure that the AC outlet you are using is easily accessible. If some trouble or malfunction occurs, immediately turn off the power switch and disconnect the plug from the outlet. Even when the power switch is turned off, electricity is still flowing to the product at the minimum level. When you are not using the product for a long time, make sure to unplug the power cord from the wall AC outlet.
- Use the included module holder if you are installing the DTX-PROX on the drum hardware. Also, make sure you use the wing bolts included with the module holder. Failure to do so could cause damage to the internal components or result in the instrument falling over.
- Take care when setting up cables. If anyone were to trip on a cable, the instrument could topple over and cause injury.

### **Connections**

- Before connecting the instrument to other electronic components, turn off the power for all components. Before turning the power on or off for all components, set all volume levels to minimum.
- Be sure to set the volumes of all components at their minimum levels and gradually raise the volume controls while playing the instrument to set the desired listening level.

### **Handling caution**

- Do not insert a finger or hand in any gaps on the instrument.
- Never insert or drop paper, metallic, or other objects into the gaps on the panel. This could cause physical injury to you or others, damage to the instrument or other property, or operational failure.
- Do not rest your weight on, or place heavy objects on the instrument, and do not use excessive force on the buttons, switches or connectors.
- Keep small parts out of the reach of infants. Your children may accidentally swallow them.
- Do not use the instrument/device or headphones for a long period of time at a high or uncomfortable volume level, since this can cause permanent hearing loss. If you experience any hearing loss or ringing in the ears, consult a physician.

Yamaha cannot be held responsible for damage caused by improper use or modifications to the instrument, or data that is lost or destroyed.

Always turn the power off when the instrument is not in use.

Even when the [  ] (Standby/On) switch is in standby status (display is off), electricity is still flowing to the instrument at the minimum level.

When you are not using the instrument for a long time, make sure you unplug the power cord from the wall AC outlet.

## NOTICE

To avoid the possibility of malfunction/ damage to the product, damage to data, or damage to other property, follow the notices below.

### ■ Handling

- Do not use the instrument in the vicinity of a TV, radio, stereo equipment, mobile phone, or other electric devices. Otherwise, the instrument, TV, or radio may generate noise.  
When you use the instrument along with an application on your smart device such as a smartphone or tablet, we recommend that you set Wi-Fi or *Bluetooth* to on after setting "Airplane Mode" to on on that device in order to avoid noise caused by communication.
- Do not expose the instrument to excessive dust or vibrations, or extreme cold or heat (such as in direct sunlight, near a heater, or in a car during the day) to prevent the possibility of panel disfiguration, damage to the internal components or unstable operation.
- Do not place vinyl, plastic or rubber objects on the instrument, since this might discolor the panel.

### ■ Maintenance

- When cleaning the instrument, use a soft and dry/slightly damp cloth. Do not use paint thinners, solvents, alcohol, cleaning fluids, or chemical-impregnated wiping cloths.

### ■ Saving data

- System settings (Reference Manual (PDF)) are retained when the power is turned off. However, the saved data may be lost due to some failure, an operation mistake, etc. Save your important data onto USB flash drive/an external device such as a computer (Reference Manual (PDF)). Before using a USB flash drive, make sure to refer to page 21.
- Edited Kit/Click, etc. are lost when you turn off the power to the instrument. This also occurs when the power is turned off by the Auto Power Off function (page 19). Save the data to the instrument, or to USB flash drive/an external device such as a computer (Reference Manual (PDF)). However, the data saved to the instrument may be lost due to some failure, an operation mistake, etc. Save your important data onto USB flash drive/an external device such as a computer (Reference Manual (PDF)). Before using a USB flash drive, make sure to refer to page 21.
- To protect against data loss through USB flash drive damage, we recommend that you save your important data onto spare USB flash drive or an external device such as a computer as backup data.

## About Bluetooth

*Bluetooth* is a technology for wireless communication between devices within an area of about 10 meters (33 ft.) employing the 2.4 GHz frequency band.

### ■ Handling Bluetooth communications

- The 2.4 GHz band used by *Bluetooth* compatible devices is a radio band shared by many types of equipment. While *Bluetooth* compatible devices use a technology minimizing the influence of other components using the same radio band, such influence may reduce the speed or distance of communications and in some cases interrupt communications.
- The speed of signal transfer and the distance at which communication is possible differs according to the distance between the communicating devices, the presence of obstacles, radio wave conditions and the type of equipment.
- Yamaha does not guarantee all wireless connections between this unit and devices compatible with *Bluetooth* function.

## Information

### ■ About copyrights

- Copying of the commercially available musical data including but not limited to MIDI data and/or audio data is strictly prohibited except for your personal use.
- This product incorporates and bundles contents in which Yamaha owns copyrights or with respect to which Yamaha has license to use others' copyrights. Due to copyright laws and other relevant laws, you are NOT allowed to distribute media in which these contents are saved or recorded and remain virtually the same or very similar to those in the product.
  - \* The contents described above include a computer program, Accompaniment Style data, MIDI data, WAVE data, voice recording data, a score, score data, etc.
  - \* You are allowed to distribute medium in which your performance or music production using these contents is recorded, and the permission of Yamaha Corporation is not required in such cases.

### ■ About this manual

- The illustrations and LCD screens as shown in this manual are for instructional purposes only, and may appear somewhat different from those on your instrument.
- Windows is a registered trademark of Microsoft® Corporation in the United States and other countries.
- Apple, Mac, Macintosh, iPhone, iPad, iPod touch are trademarks of Apple Inc., registered in the U.S. and other countries.
- Android is a trademark of Google LLC.
- The *Bluetooth*® word mark and logos are registered trademarks owned by *Bluetooth* SIG, Inc. and any use of such marks by Yamaha Corporation is under license.



- The company names and product names in this manual are the trademarks or registered trademarks of their respective companies.
- The names of buttons, terminals, and the like from the DTX-PROX's front, rear and top panels are enclosed in [ ] (square brackets).

### ■ Latest Firmware Version

From time to time, Yamaha may update product firmware without prior notice.

We recommend, therefore, that you check our web site (below) for the latest version and keep your DTX-PROX firmware up to date.

<https://download.yamaha.com/>

The content of this Owner's Manual applies to the newest version of the firmware as of printing. Details regarding any functions added to later versions will also be made available via the above web site.

### ■ About the Electronic Drum Pads (Pads)

Within this Owner's Manual, the optional external pads that may be connected to the DTX-PROX are referred to by model name. Please note that these model names were up-to-date as of printing of this manual.

Details regarding any subsequently released models will be made available via the following web site.

<https://download.yamaha.com/>

- \* Yamaha Corporation reserves the right to modify this URL at any time without prior notice.



This transmitter must not be co-located or operated in conjunction with any other antenna or transmitter.

This equipment complies with FCC radiation exposure limits set forth for an uncontrolled environment and meets the FCC radio frequency (RF) Exposure Guidelines. This equipment has very low levels of RF energy that is deemed to comply without testing of specific absorption rate (SAR).

This equipment complies with IC radiation exposure limits set forth for an uncontrolled environment and meets RSS-102 of the IC radio frequency (RF) Exposure rules. This equipment has very low levels of RF energy that is deemed to comply without testing of specific absorption rate (SAR).

This device complies with Industry Canada's licence-exempt RSSs. Operation is subject to the following two conditions:

- (1) This device may not cause interference; and
- (2) This device must accept any interference, including interference that may cause undesired operation of the device.

#### EN SIMPLIFIED EU DECLARATION OF CONFORMITY / SIMPLIFIED UK DECLARATION OF CONFORMITY

Hereby, Yamaha Music Europe GmbH declares that the radio equipment type [DTX-PROX] is in compliance with Directive 2014/53/EU and the radio equipment regulations of UK. The full texts of the EU declaration of conformity and the UK declaration of conformity are available at the following internet address: <https://europe.yamaha.com/en/support/compliance/doc.html>

#### FR DECLARATION UE DE CONFORMITE SIMPLIFIEE

Le soussigné, Yamaha Music Europe GmbH, déclare que l'équipement radioélectrique du type [DTX-PROX] est conforme à la directive 2014/53/UE. Le texte complet de la déclaration UE de conformité est disponible à l'adresse internet suivante: <https://europe.yamaha.com/en/support/compliance/doc.html>

#### DE VEREINFACHTE EU-KONFORMITÄTSERKLÄRUNG

Hiermit erklärt Yamaha Music Europe GmbH, dass der Funkanlagentyp [DTX-PROX] der Richtlinie 2014/53/EU entspricht. Der vollständige Text der EU-Konformitätserklärung ist unter der folgenden Internetadresse verfügbar: <https://europe.yamaha.com/en/support/compliance/doc.html>

#### SV FÖRENKLAD EU-FÖRSÄKRAN OM ÖVERENSSTÄMMELSE

Härmed försäkras Yamaha Music Europe GmbH att denna typ av radioutrustning [DTX-PROX] överensstämmer med direktiv 2014/53/EU. Den fullständiga texten till EU-försäkran om överensstämmelse finns på följande webbadress: <https://europe.yamaha.com/en/support/compliance/doc.html>

#### IT DICHIARAZIONE DI CONFORMITÀ UE SEMPLIFICATA

Il fabbricante, Yamaha Music Europe GmbH, dichiara che il tipo di apparecchiatura radio [DTX-PROX] è conforme alla direttiva 2014/53/UE. Il testo completo della dichiarazione di conformità UE è disponibile al seguente indirizzo Internet: <https://europe.yamaha.com/en/support/compliance/doc.html>

#### ES DECLARACIÓN UE DE CONFORMIDAD SIMPLIFICADA

Por la presente, Yamaha Music Europe GmbH declara que el tipo de equipo radioeléctrico [DTX-PROX] es conforme con la Directiva 2014/53/UE. El texto completo de la declaración UE de conformidad está disponible en la dirección Internet siguiente: <https://europe.yamaha.com/en/support/compliance/doc.html>

#### PT DECLARAÇÃO UE DE CONFORMIDADE SIMPLIFICADA

O(a) abaixo assinado(a) Yamaha Music Europe GmbH declara que o presente tipo de equipamento de rádio [DTX-PROX] está em conformidade com a Diretiva 2014/53/UE. O texto integral da declaração de conformidade está disponível no seguinte endereço de Internet: <https://europe.yamaha.com/en/support/compliance/doc.html>

#### NL VEREENVOUDIGDE EU-CONFORMITEITSVERKLARING

Hierbij verklaar ik, Yamaha Music Europe GmbH, dat het type radioapparatuur [DTX-PROX] conform is met Richtlijn 2014/53/EU. De volledige tekst van de EU-conformiteitsverklaring kan worden geraadpleegd op het volgende internetadres: <https://europe.yamaha.com/en/support/compliance/doc.html>

#### BG ОПРОСТЕНА ЕС ДЕКЛАРАЦИЯ ЗА СЪОТВЕТСТВИЕ

С настоящото Yamaha Music Europe GmbH декларира, че този тип радиосъоръжение [DTX-PROX] е в съответствие с Директива 2014/53/ЕС. Цялостният текст на ЕС декларацията за съответствие може да се намери на следния интернет адрес: <https://europe.yamaha.com/en/support/compliance/doc.html>

#### CS ZJEDNODUŠENÉ EU PROHLÁŠENÍ O SHODĚ

Tímto Yamaha Music Europe GmbH prohlašuje, že typ rádiového zařízení [DTX-PROX] je v souladu se směrnicí 2014/53/EU. Úplné znění EU prohlášení o shodě je k dispozici na této internetové adrese: <https://europe.yamaha.com/en/support/compliance/doc.html>

#### DA FORENKLET EU-OVERENSSTEMMELSESESKLÆRING

Hermed erklærer Yamaha Music Europe GmbH, at radioudruststypen [DTX-PROX] er i overensstemmelse med direktiv 2014/53/EU. EU-overensstemmelsestekstens fulde tekst kan findes på følgende internetadresse: <https://europe.yamaha.com/en/support/compliance/doc.html>

#### ET LIHTSUSTATUD ELI VASTAVUSDEKLARATSIOON

Käesolevaga deklareerib Yamaha Music Europe GmbH, et käesolev raadioseadme tüüp [DTX-PROX] vastab direktiivi 2014/53/EL nõuetele. ELi vastavusdeklaratsiooni täielik tekst on kättesaadav järgmisel internetiaadressil: <https://europe.yamaha.com/en/support/compliance/doc.html>

#### EL ΑΠΛΟΥΣΤΕΥΜΕΝΗ ΔΗΛΩΣΗ ΣΥΜΜΟΡΦΩΣΗΣ ΕΕ

Με την παρούσα ο/η Yamaha Music Europe GmbH, δηλώνει ότι ο ραδιοεξοπλισμός [DTX-PROX] πληροί την οδηγία 2014/53/ΕΕ. Το πλήρες κείμενο της δήλωσης συμμόρφωσης ΕΕ διατίθεται στην ακόλουθη ιστοσελίδα στο διαδίκτυο: <https://europe.yamaha.com/en/support/compliance/doc.html>

#### HR POJEDNOSTAVLJENA EU IZJAVA O SUKLADNOSTI

Yamaha Music Europe GmbH ovime izjavljuje da je radijska oprema tipa [DTX-PROX] u skladu s Direktivom 2014/53/EU. Cjeloviti tekst EU izjave o sukladnosti dostupan je na sljedećoj internetskoj adresi: <https://europe.yamaha.com/en/support/compliance/doc.html>

#### LV VIENKĀRŠOTA ES ATBILSTĪBAS DEKLARĀCIJA

Ar šo Yamaha Music Europe GmbH deklarē, ka radioiekārtā [DTX-PROX] atbilst Direktīvai 2014/53/ES. Pilns ES atbilstības deklarācijas teksts ir pieejams šādā interneta vietnē: <https://europe.yamaha.com/en/support/compliance/doc.html>

#### LT SUPAPRASTINTA ES ATITIKTIES DEKLARACIJA

Aš, Yamaha Music Europe GmbH, patvirtinu, kad radijo įrenginių tipas [DTX-PROX] atitinka Direktyvą 2014/53/ES. Visas ES atitikties deklaracijos tekstas prieinamas šiuo interneto adresu: <https://europe.yamaha.com/en/support/compliance/doc.html>

#### HU EGYSZERŰSÍTETT EU-MEGFELELŐSÉGI NYILATKOZAT

Yamaha Music Europe GmbH igazolja, hogy a [DTX-PROX] típusú rádióberendezés megfelel a 2014/53/EU irányelvnek. Az EU-megfelelőségi nyilatkozat teljes szövege elérhető a következő internetes címen: <https://europe.yamaha.com/en/support/compliance/doc.html>

#### PL UPROSZCZONA DEKLARACJA ZGODNOŚCI UE

Yamaha Music Europe GmbH niniejszym oświadcza, że typ urządzenia radiowego [DTX-PROX] jest zgodny z dyrektywą 2014/53/UE. Pełny tekst deklaracji zgodności UE jest dostępny pod następującym adresem internetowym: <https://europe.yamaha.com/en/support/compliance/doc.html>

#### RO DECLARAȚIA UE DE CONFORMITATE SIMPLIFICATĂ

Prin prezenta, Yamaha Music Europe GmbH declară că tipul de echipamente radio [DTX-PROX] este în conformitate cu Directiva 2014/53/UE. Textul integral al declarației UE de conformitate este disponibil la următoarea adresă internet: <https://europe.yamaha.com/en/support/compliance/doc.html>

#### SK ZJEDNODUŠENÉ EÚ VYHLÁSENIE O ZHODE

Yamaha Music Europe GmbH týmto vyhlasuje, že rádiové zariadenie typu [DTX-PROX] je v súlade so smernicou 2014/53/EÚ. Úplné EÚ vyhlásenie o zhode je k dispozícii na tejto internetovej adrese: <https://europe.yamaha.com/en/support/compliance/doc.html>

#### SL POENOSTAVLJENA IZJAVA EU O SKLADNOSTI

Yamaha Music Europe GmbH potrjuje, da je tip radijske opreme [DTX-PROX] skladen z Direktivo 2014/53/EU. Celotno besedilo izjave EU o skladnosti je na voljo na naslednjem spletnem naslovu: <https://europe.yamaha.com/en/support/compliance/doc.html>

#### FI YKSINKERTAISTETTU EU-VAATIMUSTENMUKAISUUSVAKUUTUS

Yamaha Music Europe GmbH vakuuttaa, että radiolaitetyypin [DTX-PROX] on direktiivin 2014/53/EU mukainen. EU-vaatimustenmukaisuusvakuutuksen täysimittainen teksti on saatavilla seuraavassa internetosoitteessa: <https://europe.yamaha.com/en/support/compliance/doc.html>

#### TR BASITLEŞTİRİLMİŞ AVRUPA BİRLİĞİ UYGUNLUK BİLDİRİMİ

İşbu belge ile, Yamaha Music Europe GmbH, radyo cihaz tipinin [DTX-PROX], Direktif 2014/53/ AB'ye uygunluğunu beyan eder. AB uyumu beyanının tam metni aşağıdaki internet adresinden edinilebilir: <https://europe.yamaha.com/en/support/compliance/doc.html>

Importer: Yamaha Music Europe GmbH  
Siemensstrasse 22-34, 25462 Rellingen, Germany

## Welcome

Thank you for purchasing this Yamaha DTX-PROX.

The DTX-PROX is a drum trigger module that you can use for playing electronic drum kits and drum pads at homes, studios or live venues.

To get the most out of your DTX-PROX, be sure to read this Owner's Manual carefully. And after reading through this manual, be sure to store it in a safe place so that you can refer back to it again as needed.

### Included Accessories

Owner's Manual (this book)

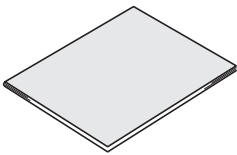

Module holder

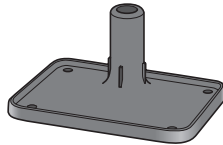

AC adaptor

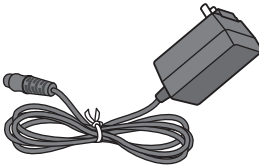

Module holder wing bolts (× 4)

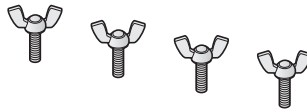

Cubase AI Download Information

### How to Attach the Module Holder

Exploded view

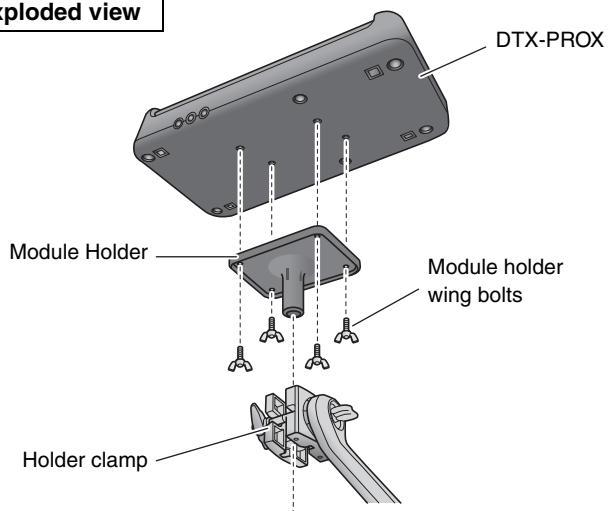

#### NOTE

The module holder is compatible with standard drum hardware (22.2-mm or 7/8-inch diameter).

# About the Manuals

The following manuals are provided for using the DTX-PROX. These manuals are intended for users of the DTX-PROX.

## Printed Manual



### Owner's Manual (this book)

#### Setup Guide

Explains how to attach and setup the DTX-PROX for producing sound.

#### Basic Guide

Describes the fundamentals needed to operate the DTX-PROX.

#### Application Guide

Describes parameter settings and other more advanced uses.

#### Reference

Describes troubleshooting techniques and contains other reference materials.

## Digital Manual (PDF)



### Reference Manual

The Reference Manual provides a description of all the functions that can be accessed by pressing the [MENU] button as well as other advanced settings that can be used with the DTX-PROX.



### Data List

This provides lists of Kit and Effect names in the DTX-PROX, and MIDI related information.



### iPhone/iPad Connection Manual Smart Device Connection Manual for Android™

Describes how to connect smartphones and tablets.

The digital format manuals listed above can be obtained from the Yamaha Downloads web page. To do so, go to the web page using the following URL, enter "DTX-PROX" in the "Model Name" field, and then click "Search."

Yamaha Downloads: <https://download.yamaha.com/>

# Features of the DTX-PROX

## ● Intuitive operation for playing your ideal drum sounds

- ✓ Includes natural drum sounds with real ambience, played by top studio drummers and recorded in renowned studios, including Real World Studios.
- ✓ Includes unique KIT MODIFIERS giving you intuitive control of Ambience, Comp, and Effects—the core elements of the drum sound creation (page 33).
- ✓ Equipped with a high-quality headphone amplifier that delivers high fidelity reproduction of all drum sounds.
- ✓ High-quality tone generator that enables natural expressive control like that of acoustic drums—with high-definition dynamics, high-performance effects processing, position sensing <sup>(\*1)</sup> on snare and ride cymbal pads, low latency and 256 polyphony.
- ✓ The instrument features LED rotary faders that allow easy access to parameters for drum sound creation and intuitive control of external devices during live performances

## ● Useful for live performance

- ✓ The Live Set feature lets you prepare a custom sequence of kit, tempo, audio file, and other parameters in, for example, the order of a performance set list and switch among settings with a single step operation as you play live.
- ✓ Routing flexibility enables each of the instrument sounds, such as snare and kick, to be sent separately to the mixer using 8 lines from the INDIVIDUAL OUTPUT jacks.
- ✓ Both stereo phone and stereo mini jacks are available for PHONES and AUX IN. No adaptor or mixer is needed when connecting external devices.

## ● Boost your drumming skills through effective practice

- ✓ A sophisticated programmable metronome allows you to adjust the volume of each click beat, change the tone of the click sound, and much more (page 42).
- ✓ You can record or playback your songs using the build-in recorder or a USB flash drive (page 46).

## ● Enables you to create music, make a video of your performance, and share your video over the Internet.

- ✓ The instrument is compatible with iOS or Android apps such as Rec'n'Share. By digitally connecting to smart devices via a USB cable, you can record and playback high quality sound. You can also play the drums along with your favorite music or make a video of your performance for uploading to social networking sites <sup>(\*2)</sup> (page 23).
- ✓ Audio playback available via *Bluetooth* Audio connection <sup>(\*3)</sup>
- ✓ Includes Steinberg Cubase AI for comprehensive music production tools (page 54).

\*1 For more information on the list of compatible drum pads, refer to the Pad Module Compatibility Table.

\*2 The DTX-PROX is a class compliant USB device. A separate cable is required for connecting to a computer or to a smartphone.

\*3 For details, see "Panel Controls and Functions" on page 10.

# Contents

---

<b>PRECAUTIONS</b>	<b>2</b>
--------------------	----------

---

<b>Welcome</b>	<b>6</b>
----------------	----------

---

<b>Included Accessories</b>	<b>6</b>
-----------------------------	----------

---

<b>About the Manuals</b>	<b>7</b>
Printed Manual.....	7
Digital Manual (PDF) .....	7

---

<b>Features of the DTX-PROX</b>	<b>8</b>
---------------------------------	----------

---

<b>Panel Controls and Functions</b>	<b>10</b>
Top Panel .....	10
Front Panel .....	12
Rear Panel.....	13

---

<b>Setup Guide</b>	<b>14</b>
Preparations .....	14
Installing the DTX-PROX .....	14
Turning On or Off.....	17
Changing the Overall Settings .....	19
Using a USB Flash Drive .....	21
Using Smart Devices .....	23
Listening to Audio Data from a Smart Device through the DTX-PROX ( <i>Bluetooth</i> Audio Function) .....	24

---

<b>Basic Guide</b>	<b>26</b>
Structure of the Kit.....	26
Playing the Pads.....	27
Basic Operation of the DTX-PROX.....	32
Changing the Drum Set Sound (Building Your Own Drum Set) .	34
Using the Click (Metronome) .....	42
Creating Your Own Click (Metronome) Settings.....	43
Changing the Trigger Settings .....	45
Recording Your Performance .....	46
Connecting a PA System.....	49
Using Live Sets.....	50

---

<b>Application Guide</b>	<b>51</b>
Connecting Separately Sold Add-ons and External Devices.....	51

---

<b>Reference</b>	<b>55</b>
Message List.....	55
Troubleshooting .....	57
Specifications.....	60
Index .....	61

---

# Panel Controls and Functions

## Top Panel

### Display

#### Function Buttons 1–3 ([F1], [F2], [F3])

Selects the functions that appear at the bottom of each screen.

### NOTICE

#### About the “E” mark:

The **E** mark appears in the upper right of the screen when the Kit, Click, and other settings have been changed. This is to remind you that the settings have changed but have not yet been saved (Store). The mark disappears when you store the settings (page 40). When you change the Kit or Click without first storing the settings, the changes will be lost.

### How to read the KIT screen

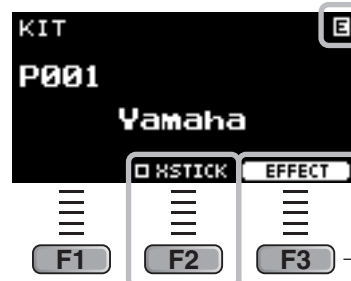

Cross stick setting (page 28)  
May not be shown depending on the pad

EFFECT screen (page 33)

### Mode Select knob

Changes the mode (Kit, Click, Trigger, Recorder and Live set). Shows the screen for each mode.

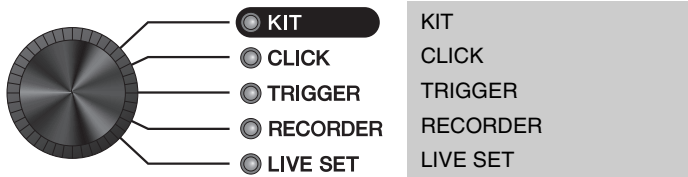

### KIT MODIFIER knobs

Adjust the amount of Ambience (the background sounds of the location), Comp (the punchiness or loudness of the sound), Effect (other effects assigned to the Kit)

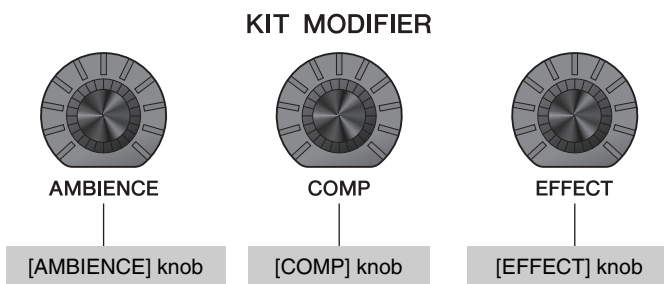

⇒ Structure of the Kit (page 26)

⇒ Adjusting (Modifying) the Sound Effects (page 33)

### Fader Select knob

Selects the function for assigning to the LED Rotary Faders. (page 34)

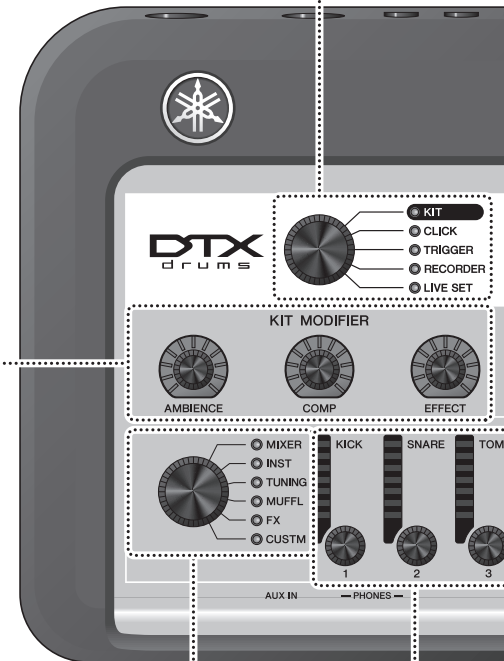
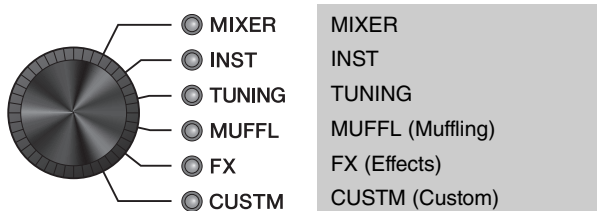

### LED Rotary Faders

Changes the settings of the function selected with the Fader Select knob. Changes in values are shown in the indicators.



**Bluetooth figure mark (page 24)**

**Bluetooth capability**

Depending on the country in which you purchased the product, the instrument may not have *Bluetooth* capability. If the *Bluetooth* logo is shown or printed on the control panel, this means that the product is equipped with *Bluetooth* functionality.

**[-][+] knob**

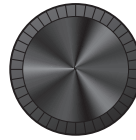

**[-] button [+] button**

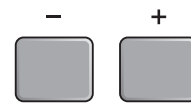

Increases or decrease the value(s).

The knob is useful for changing multiple values, while the buttons are useful for changing the value in steps. In this manual, the [-][+] knob, the [-] button and the [+] button are collectively called the “[-][+] controllers” for situations where you can use either the knob or the buttons.

**PAD SELECT**



**[PAD SELECT] button**

Shows the Trigger Input screens or the Trigger Input Source screen. For more information, refer to the Reference Manual (PDF).

**NOTE**

Press this button to select a pad while changing settings with the LED rotary faders.

**[⏻] (Standby/On) switch (page 17)**

Switches the power between standby (off) and on.

**Click Tempo Display**

**[TEMPO] knob (page 42)**

Adjusts the tempo.



CLICK

**[CLICK] button (page 42)**

Starts or stops the click (metronome). The indicator flashes in sync with the click tempo.

**AUDITION**



**[AUDITION] button**

Use this button to check the sound of the currently selected trigger input source (Reference Manual (PDF)). As a default setting, the voice assigned to the head of the snare pad connected to the [SNARE] jack is played.

**Buttons for showing screens**

**MENU**



**[MENU] button**

Accesses the advanced settings screen. For more detailed information, refer to the Reference Manual (PDF).

**STORE**



**[STORE] button**

⇒ STORE screen (page 40)

Stores Kit, Click, Trigger, or, Live set settings that you have created.

**EXIT**



**[EXIT] button**

Cancels the action or returns to the screen one level higher.

**NOTE**

This button can also be used as a Panic Button to stop the KIT sounds (on top screen for each mode).

**Sliders**

These change the corresponding volume levels.

[AUX IN] (auxiliary inputs from the [AUX IN] jacks on front and rear panels)

[AUDIO] (audio including USB audio, *Bluetooth* audio, Song, and recorder playback)

[CLICK] (click)

[OUTPUT] (outputs from the OUTPUT [R]/[L/MONO] jacks)

[PHONES] (headphones)

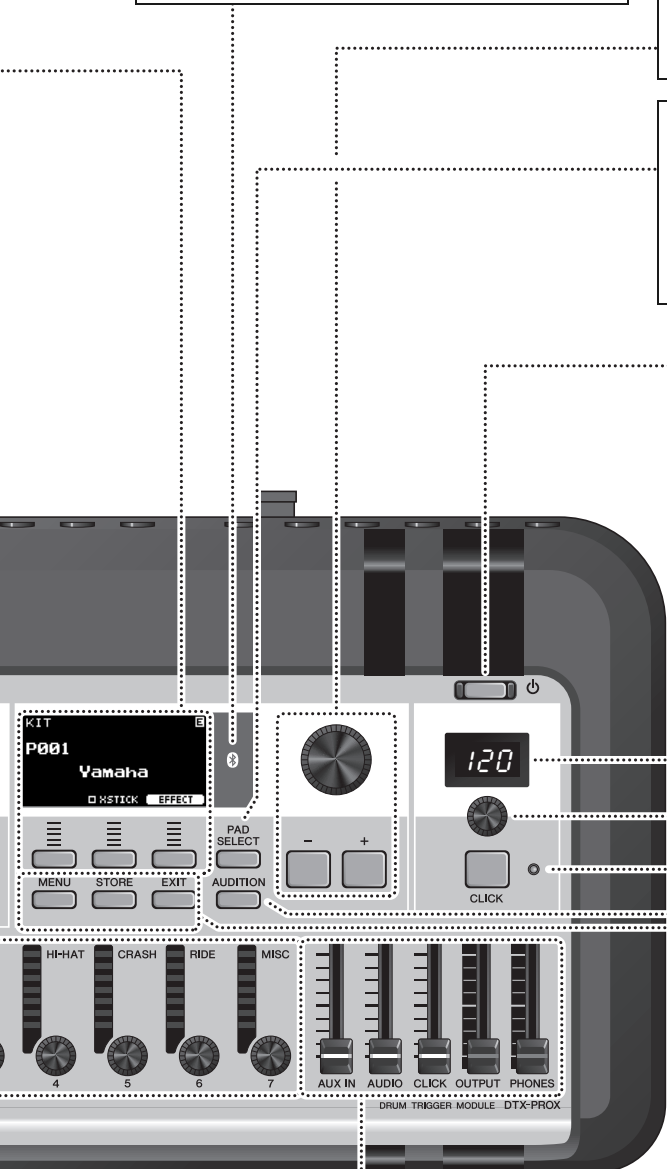

# Front Panel

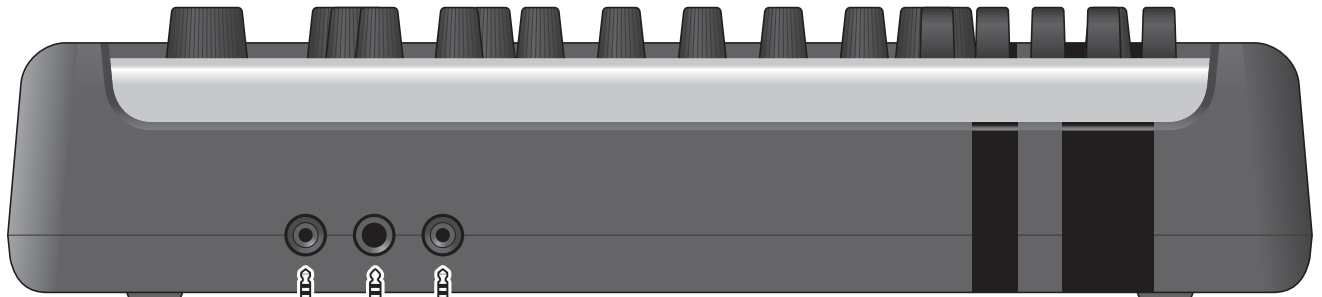

Stereo mini phone plug  
(3.5 mm)

Standard stereo phone plug  
(6.3 mm)

Stereo mini plug  
(3.5 mm)

**[PHONES] (Headphone) jack (page 16)**  
For connecting headphones. The one on the left is a standard stereo phone type (6.3 mm) output jack, and the one on the right is a stereo mini phone type (3.5 mm) output jack.

**⚠ CAUTION**  
Do not use headphones for a long period of time at high volume. Doing so can cause loss of hearing.



**[AUX IN] (auxiliary input) jack**  
Connect to the headphone jack on a smart phone or portable music player.





# Rear Panel

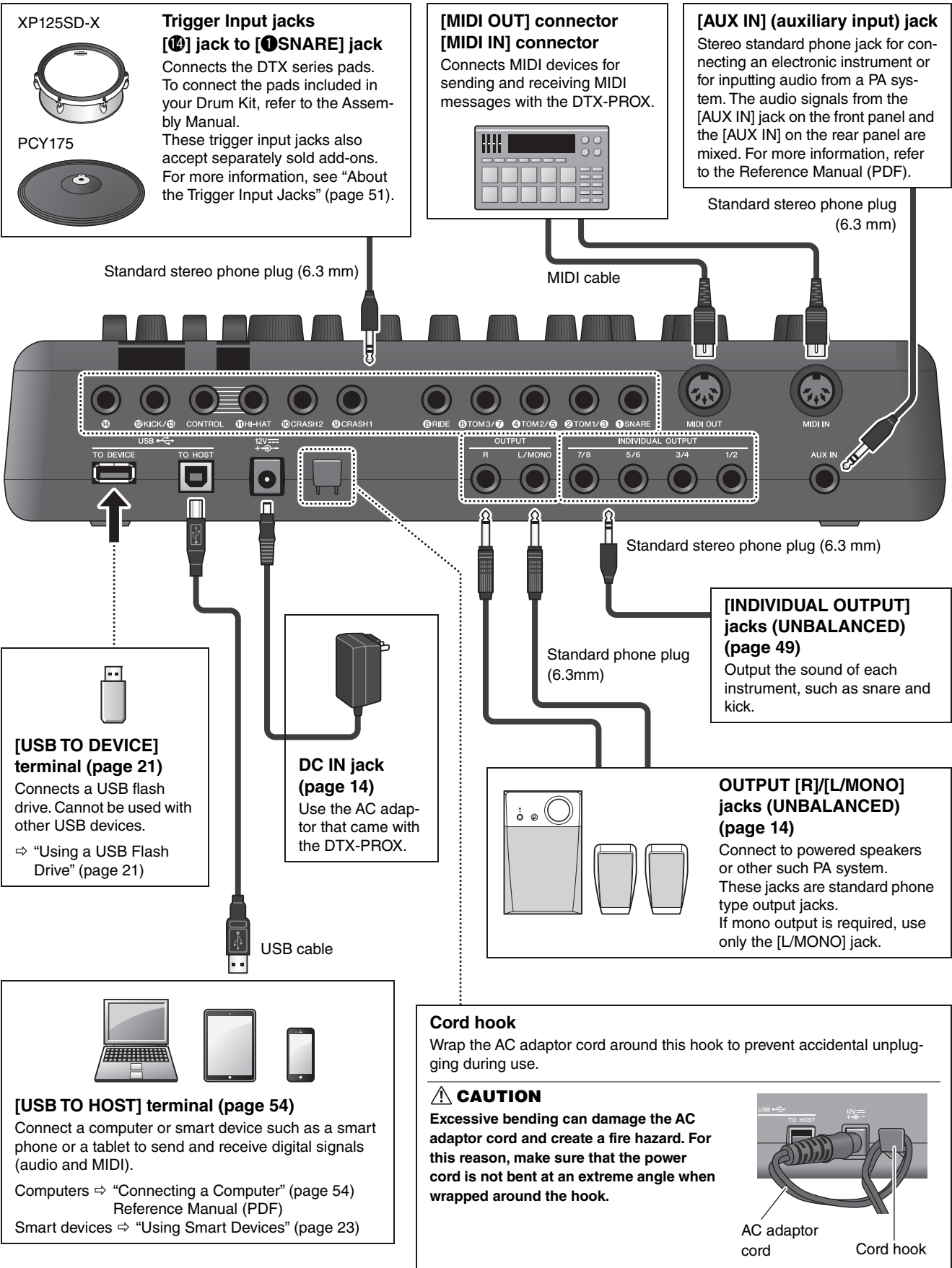

XP125SD-X



PCY175



**Trigger Input jacks**  
**[KICK] jack to [SNARE] jack**  
 Connects the DTX series pads. To connect the pads included in your Drum Kit, refer to the Assembly Manual. These trigger input jacks also accept separately sold add-ons. For more information, see "About the Trigger Input Jacks" (page 51).

**[MIDI OUT] connector**  
**[MIDI IN] connector**  
 Connects MIDI devices for sending and receiving MIDI messages with the DTX-PROX.



**[AUX IN] (auxiliary input) jack**  
 Stereo standard phone jack for connecting an electronic instrument or for inputting audio from a PA system. The audio signals from the [AUX IN] jack on the front panel and the [AUX IN] on the rear panel are mixed. For more information, refer to the Reference Manual (PDF).

Standard stereo phone plug (6.3 mm)

Standard stereo phone plug (6.3 mm)

MIDI cable

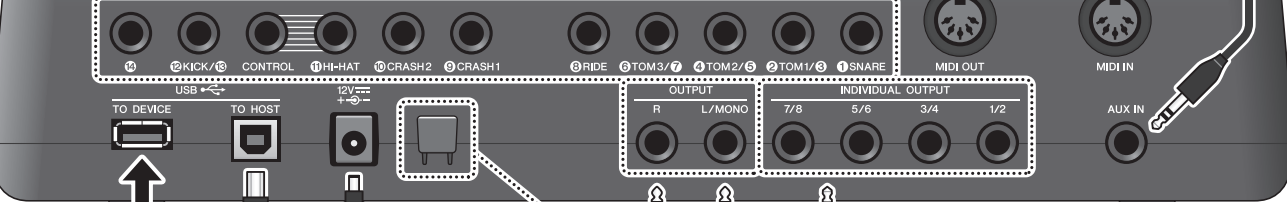

Standard stereo phone plug (6.3 mm)

Standard phone plug (6.3mm)

**[USB TO DEVICE] terminal (page 21)**  
 Connects a USB flash drive. Cannot be used with other USB devices.  
 ⇒ "Using a USB Flash Drive" (page 21)

**DC IN jack (page 14)**  
 Use the AC adaptor that came with the DTX-PROX.

**[INDIVIDUAL OUTPUT] jacks (UNBALANCED) (page 49)**  
 Output the sound of each instrument, such as snare and kick.

**OUTPUT [R]/[L/MONO] jacks (UNBALANCED) (page 14)**  
 Connect to powered speakers or other such PA system. These jacks are standard phone type output jacks. If mono output is required, use only the [L/MONO] jack.

**[USB TO HOST] terminal (page 54)**  
 Connect a computer or smart device such as a smart phone or a tablet to send and receive digital signals (audio and MIDI).  
 Computers ⇒ "Connecting a Computer" (page 54) Reference Manual (PDF)  
 Smart devices ⇒ "Using Smart Devices" (page 23)

**Cord hook**  
 Wrap the AC adaptor cord around this hook to prevent accidental unplugging during use.

**CAUTION**  
 Excessive bending can damage the AC adaptor cord and create a fire hazard. For this reason, make sure that the power cord is not bent at an extreme angle when wrapped around the hook.

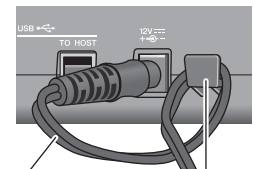

AC adaptor cord      Cord hook

# Setup Guide

## Preparations

This provides information on setup and initial settings in preparation for playing.

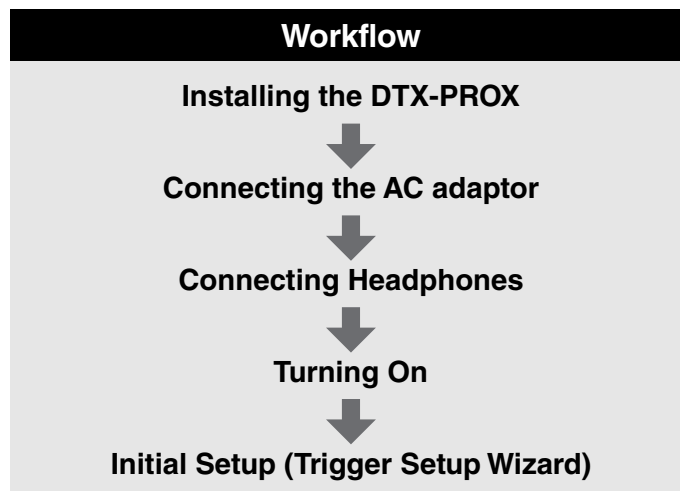

**This completes set up.**

## Installing the DTX-PROX

First, install the DTX-PROX.

There are three different ways of installation as shown below.

- Attach the DTX-PROX onto the rack of your drum kit. (For more information, refer to the Assembly Manual.)
- Use the included module holder (page 6) to attach the standard drum hardware. (See “Integrating Electronic & Acoustic Drums” on page 53.)
- Place on a flat surface

After installing the DTX-PROX, connect cables to the Pads. For more information on the connections, refer to the specific Assembly Manual of your drum kit.

## ■ Connecting the AC adaptor

### ⚠ WARNING

Only use the specified AC adaptor (page 60). Using a different AC adaptor can cause malfunction, overheating, fire, and other problems. This may void the warranty so please take careful note.

### ⚠ CAUTION

Locate the DTX-PROX close to an AC outlet. If you notice any abnormalities during operation, turn the power off immediately and unplug the AC adaptor.

1. Make sure that the power is turned off (all panel lights and the screen backlight are off).

No screen backlight

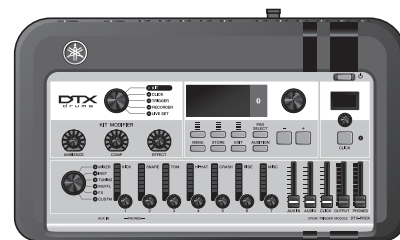

2. For removable plug type AC adaptors only: Make sure that the plug is not disconnected.

### ⚠ WARNING

- For AC adaptors with a removable plug, only use the AC adaptor with the plug attached, and keep the plug. Plugging only the plug into the power outlet can cause electric shock or fire.
- If the removable plug comes off from the AC adaptor, avoid touching the metal parts on the plug and slide the AC adaptor onto the plug until you hear it lock on to the adaptor with a click. Also, make sure you keep any foreign objects out of the plug. This can cause electrical shock, short circuit, or failure.

Slide in the direction indicated with the arrow.

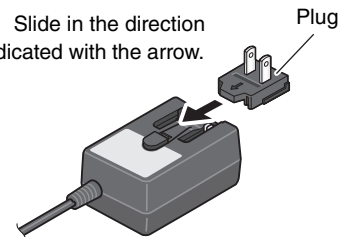

3. Connect the AC adaptor.

### ⚠ WARNING

Make sure to use the specified AC adaptor.

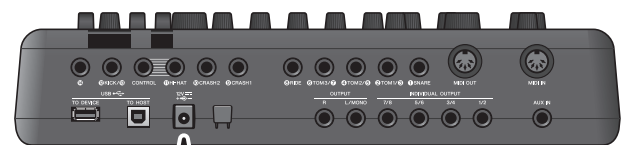

12V  
DC IN jack  
(page 60)

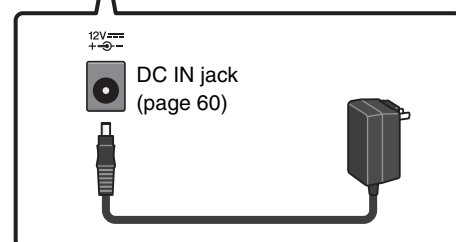

**4. Hook the AC adaptor’s cord around the cord hook to secure it in place.**

**⚠ CAUTION**

Excessive bending can damage the AC adaptor cord and create a fire hazard. Ensure, therefore, that the power cord is not bent at an extreme angle when wrapped around the hook.

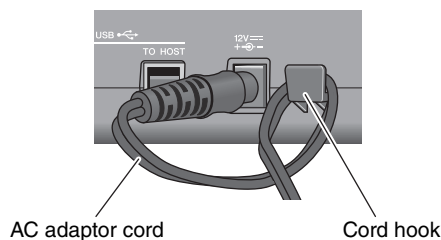

**5. Plug the AC adaptor’s AC plug into a domestic power outlet.**

**⚠ CAUTION**

Even when the [⏻] (Standby/On) switch is in standby status (display is off), electricity is still flowing to the instrument at the minimum level. When you are not using the DTX-PROX for a long period of time, make sure that you unplug the AC adaptor from the wall AC outlet.

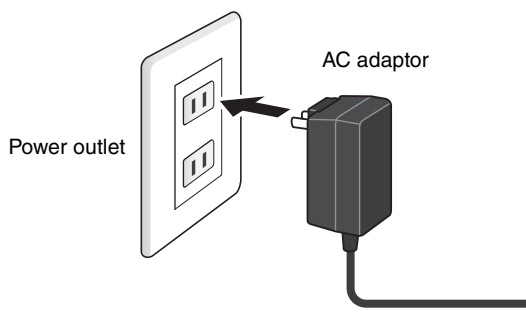

**NOTE**

When disconnecting the AC adaptor, turn the instrument and then carry out this procedure in reverse order.

**■ Connecting Headphones**

Connect the headphones to the [PHONES] (headphone) jack.

**⚠ CAUTION**

Do not use headphones at high volume for an extended period of time. Doing so can cause loss of hearing.

To adjust the headphone volume, use the [PHONES] slider. To adjust the headphone EQ, set the Fader Select knob to “CUSTM,” and use the LED rotary faders.

One standard stereo phone jack and one stereo mini phone jack are available. Select the proper jack that matches the connector size of the cable. The output volume may be lower than expected if both phone jacks are used at the same time.

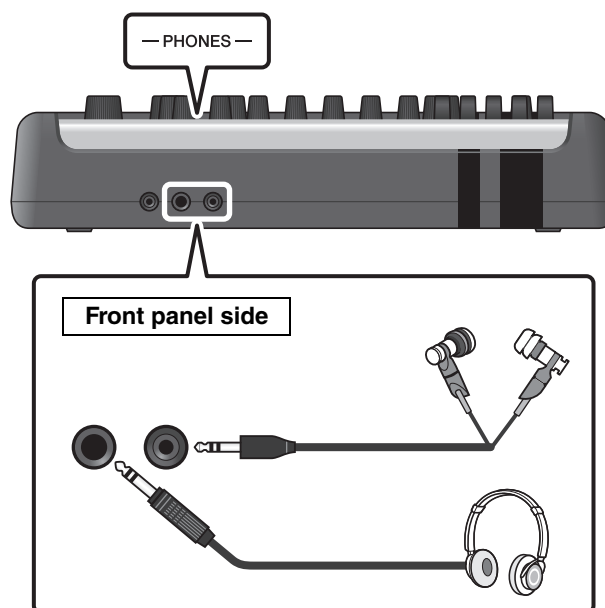

## Turning On or Off

### ■ Turning On

1. Lower the [OUTPUT] and [PHONES] sliders to set the volume levels to their minimum.

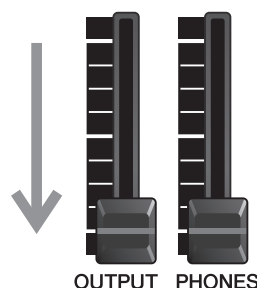

2. Press the [⏻] (Standby/On) switch.



#### IMPORTANT

#### Initial Setup (Trigger Setup Wizard)

When you turn on your DTX-PROX for the first time, the Initial Setup page will be displayed. On this page, you will be required to specify the following. When you specify the model number, the DTX-PROX will automatically optimize the trigger output levels for all of your pads.

1. Identify your drum kit using the [-][+] controllers and press the button below “OK” ([F3]).

Your drum kit’s model number is indicated on the Assembly Manual for your drum kit. Make sure to select the proper pad type (DTX\*\*K-~~X~~ or DTX\*\*K-~~M~~) for your particular drum kit.

2. When the confirmation screen appears, press the button below “YES” ([F1]).

When the initial setting is complete, the KIT screen appears.

#### NOTE

You can change the specified drum kit at any time after completing Initial Setup. (“Changing the Trigger Settings” (page 45))

If the initial setup is already complete, the KIT screen appears directly after the startup screen, without showing the Trigger Setup Wizard.



\* XSTICK: May not be shown depending on the pad

3. If you are connected to a PA system:  
Turn the external speakers on.

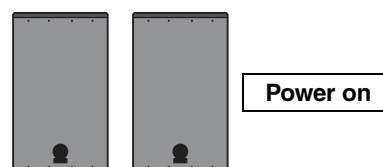

### ■ Turning Off

#### NOTICE

- The DTX-PROX automatically stores settings when the power is turned off, so do not unplug the AC adaptor until the LCD screen is turned off completely.
- Any unsaved Kit, Click, Trigger settings, and Live Set data will be lost, so always save (Store) data before turning the power off.

1. If you are connected to a PA system:  
Turn the external speakers off.

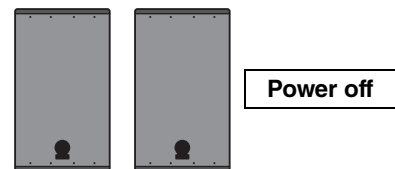

2. Lower the [OUTPUT] and [PHONES] sliders to set the volume levels to their minimum.

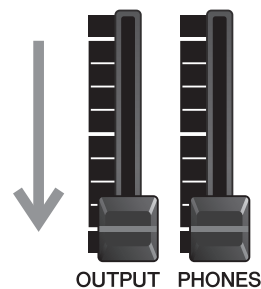

3. Hold down the [⏻] (Standby/On) switch.  
The DTX-PROX is in Standby and the display and lights are off.

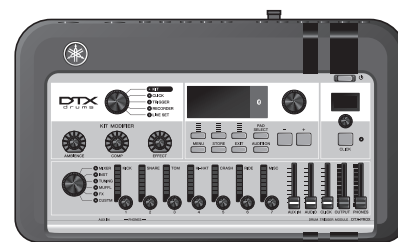

All off

## Changing the Overall Settings

### ■ Auto Power-Off

The Auto Power-Off function automatically turns off the DTX-PROX after a certain period of inactivity. The factory default is set at 30 minutes.

#### NOTICE

- Unsaved data is lost when the DTX-PROX is turned off with the Auto Power-Off function. Always store data before turning the power off.
- In certain modes of operation, the Auto Power-Off function will not turn off the DTX-PROX when the set time has elapsed. So we recommend that you always turn off the DTX-PROX manually when you are finished using it.
- If you expect the DTX-PROX to be inactive for a certain length of time while connected to external audio equipment or a PA, we recommend fully lowering the volume on the external equipment. Alternatively, you can disable the Auto Power-Off function to ensure that the DTX-PROX stays on.

#### NOTE

To set the Auto Power-Off to a time other than 30 minutes, access the setting from the [MENU] button. (MENU/Utility/General)

### ● Auto Power-Off Quick Cancel

First, make sure that the DTX-PROX is turned off. Then, while holding down the [MENU] button, press the [⏻] (Standby/On) button to cancel the Auto Power-Off function. The function will remain off until you set a new Auto Power-Off time.

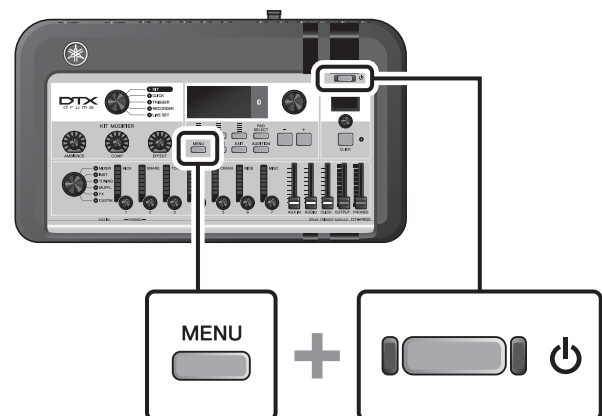

### ■ Restoring DTX-PROX Settings to the Factory Defaults (Factory Reset)

Use the Factory Reset function to restore the DTX-PROX's settings to their factory defaults, even if you have accidentally overwritten them.

#### NOTICE

A factory reset overwrites any settings you have made with the corresponding factory defaults. Save any important user-defined data to a USB flash drive before carrying out a factory reset. For more information, refer to the Reference Manual (PDF). (MENU/File)

### ● Performing a Factory Reset

First, make sure that the DTX-PROX is turned off. Then, while holding down the [-] and [+] buttons, press the [⏻] (Standby/On) button to perform the Factory Reset function.

#### NOTE

You can also access the factory reset with the [MENU] button. (MENU/Factory Reset)

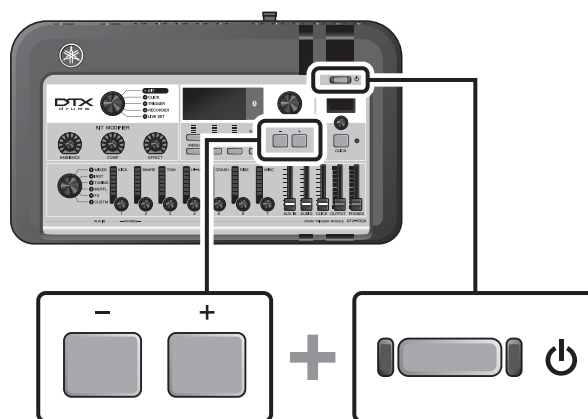



## Using a USB Flash Drive

Connect a USB flash drive to the [USB TO DEVICE] terminal on the rear panel of the DTX-PROX and record your performance directly to the USB flash drive. Also, you can save DTX-PROX settings to and load settings from a USB flash drive.

### ■ Connecting a USB Flash Drive to the DTX-PROX

#### Precautions When Using the [USB TO DEVICE] Terminal

When connecting a USB flash drive to the [USB TO DEVICE] terminal, be sure to follow the important precautions below.

**NOTE**

For more information about the handling of USB flash drives, refer to the owner's manual of your USB flash drive.

### ● Compatible USB Devices

#### USB flash drives only

Please check the URL shown below for a list of compatible USB flash drives.

<https://download.yamaha.com/>

**NOTE**

- Other USB devices such as USB hub, mouse, computer keyboard, cannot be used.
- A USB cable cannot be used to connect a USB device to the [USB TO DEVICE] terminal.

**NOTICE**

The rating of the [USB TO DEVICE] terminal is a maximum of 5 V / 500 mA. Do not connect USB devices having a rating above this, since this can cause damage to the instrument itself.

### ● Connecting a USB Flash Drive

When connecting a USB device to the [USB TO DEVICE] terminal, make sure that the connector on the DTX-PROX is appropriate and that it is connected in the proper direction.

Although USB devices 2.0 to 3.0 can be used on the DTX-PROX, the amount of time for saving to or loading from the USB device may differ depending on the type of data or the status of the instrument.

**NOTICE**

- **Avoid connecting or disconnecting the USB device during playback/recording and file management operations (such as Save, Copy, Delete, and Format), or when accessing the USB device. Failure to observe this may result in "freezing" of the operation of the instrument or corruption of the USB device and the data.**
- **When connecting then disconnecting the USB device (and vice versa), make sure to wait a few seconds between the two operations.**

#### ● Formatting the USB Flash Drive

Some USB flash drives should be formatted with this instrument before they can be used. For information on how to format the USB flash drive, refer to the Reference Manual (PDF). (MENU/File/Format)

**NOTICE**

The format operation erases any previously existing data. Make sure that the USB flash drive you are formatting does not contain any important data.

#### ● To Protect Your Data (Write Protection)

To prevent important data from being inadvertently erased, write-protect the USB flash drive. When you are saving data to the USB flash drive, make sure you disable the write-protect first.

## Using Smart Devices

Connecting a smart device to the [USB TO HOST] jack establishes a digital connection and allows you to:

- **Record and play back high-quality audio using apps**
- **Practice, record (both audio and video), and share your recordings on social networks using Rec'n'Share**

### **NOTICE**

- **Before connecting devices, make sure the volume levels on all external devices are set at their minimum.**
- **Be sure to place your smart device on a stable surface to prevent it from falling over and being damaged.**

### **NOTE**

To eliminate the risk of interference due to noise by your smart device when used in combination with the DTX-PROX, turn on the Airplane Mode and then turn on Wi-Fi.

Additional parts are required for connecting a smart device.

For more information on the connection, refer to the “iPhone/iPad Connection Manual” or “Smart Device Connection Manual for Android™.”

For details on compatible smart devices and smart device applications such as Rec'n'Share, refer to the web page below.

<https://download.yamaha.com/>

## Listening to Audio Data from a Smart Device through the DTX-PROX (*Bluetooth* Audio Function)

### **Bluetooth capability**

Depending on the country in which you purchased the product, the DTX-PROX may not have *Bluetooth* capability. If the *Bluetooth* logo is shown or printed on the top panel, this means that the product is equipped with *Bluetooth* functionality.

**Before using the *Bluetooth* function, be sure to read “About *Bluetooth*” on page 4.**

You can input the sound of the audio data saved in a *Bluetooth*-equipped device, such as a smart phone or digital audio player, to the DTX-PROX and listen to it through the headphones or speakers connected to the DTX-PROX. The input audio data can be recorded. (page 46)

#### \* *Bluetooth*-equipped device

In this manual, “*Bluetooth*-equipped device” refers to a device that can transmit audio data on it to the DTX-PROX using the *Bluetooth* function, via wireless communication. (i.e., smart phones and portable audio players.)

#### NOTE

*Bluetooth* headphones or speakers cannot be connected.

## ■ Pairing with the *Bluetooth*-equipped device

To connect the *Bluetooth*-equipped device for the first time, the *Bluetooth*-equipped device and the DTX-PROX must be “paired.” Once the device and the DTX-PROX are paired, it is not necessary to pair the two again (unless you’ve disabled pairing).

### ● Pairing

“Pairing” means to register *Bluetooth*-equipped smart devices on the DTX-PROX and establish the mutual recognition for wireless communication between the two.

#### 1. Hold down the [MENU] button.

The screen appears while the device is being paired.

To cancel pairing, use the button below “CANCEL” ([F3]).

#### 2. Turn the *Bluetooth* setting ON on the *Bluetooth*-equipped device and select “DTX-PROX AUDIO” from the list.

- Make sure to complete the settings on the smart device within 5 minutes. After that, the pairing mode ends automatically.
- If you are required to enter a passkey, enter the numerals “0000.”

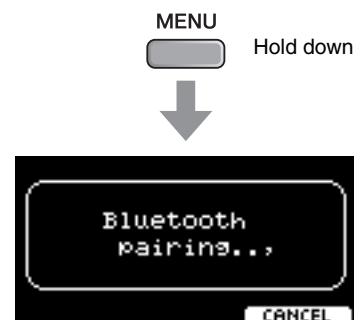

When the pairing completed, the  (*Bluetooth*) mark appears on top screen for each mode.



### 3. Play back audio data on the smart device to confirm that the headphones or speakers connected to the DTX-PROX can output the audio sound.

You can adjust the volume of the sound input via *Bluetooth* by the [AUDIO] slider.

When you turn on the DTX-PROX the next time, the last-connected smart device will be connected to the DTX-PROX automatically, if the *Bluetooth* function of the smart device and the DTX-PROX is set to on. If it is not connected automatically, select the model name of the instrument from the connection list on the smart device.

To switch the *Bluetooth* function on the DTX-PROX, press the [MENU] button to open the screen. For more information, refer to the Reference Manual (PDF). (MENU/*Bluetooth*)

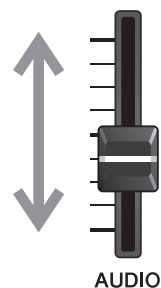

# Basic Guide

## Structure of the Kit

A Kit is a combination of drum set sounds and the sound modifier settings that enhance the sounds, such as Ambience, Comp (Compressor) and Effects. This drum trigger module contains numerous sets of preset kits, and you can change the drum set sounds by selecting another kit or by changing the sound modifier settings.

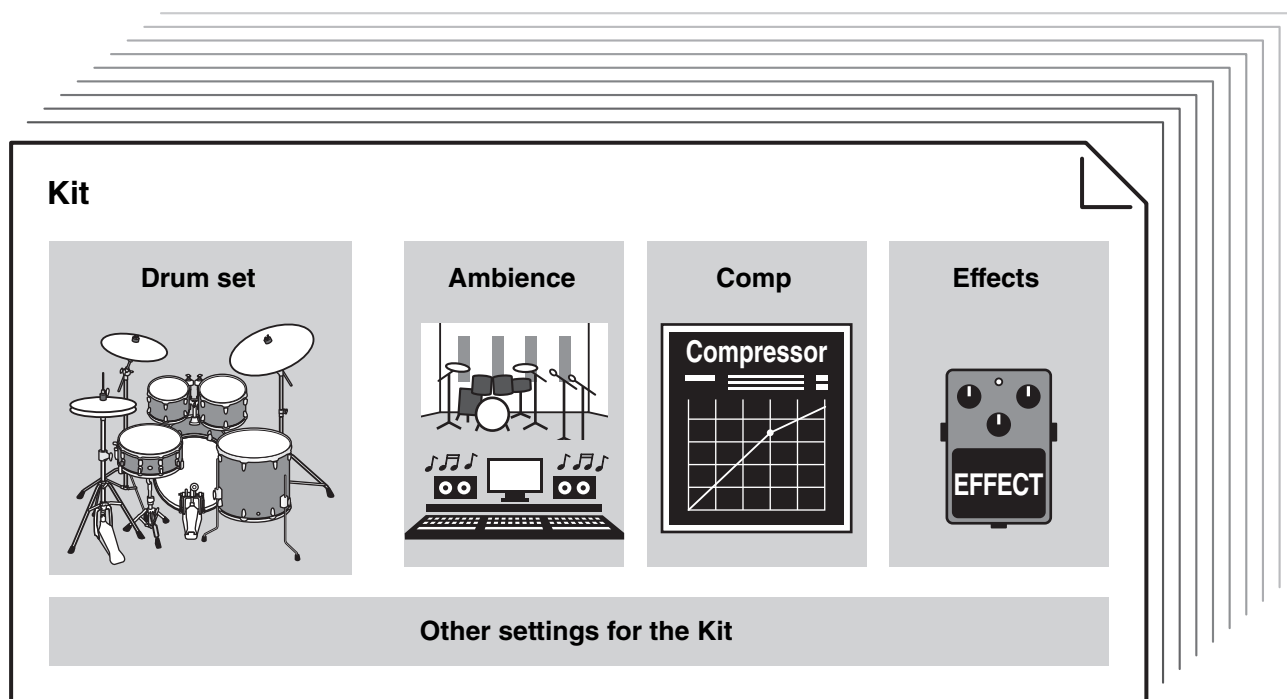

Each drum or percussion instrument in the drum set is called an instrument or "Inst," and you can play the Inst sounds by striking drum pads.

### Example of the Instruments (Inst):

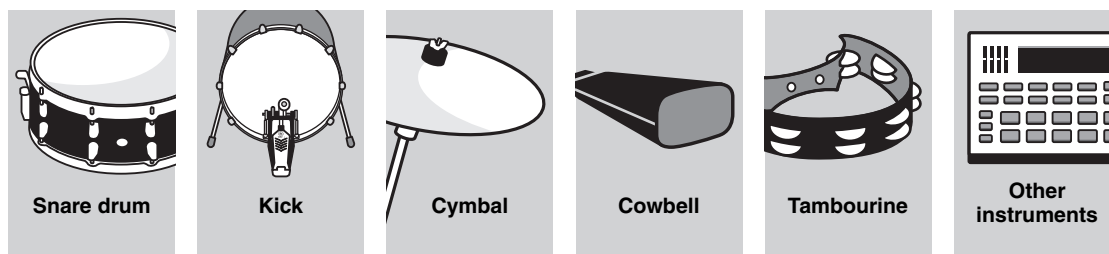

## Playing the Pads

To play the Inst sounds, strike the pads connected to the DTX-PROX.

You can play different sounds by striking different sections (or “Zones”) of the pad, depending on the number of zones available on the pad.

When position sensing is available, you can express a subtle nuance by striking different locations within a Zone.

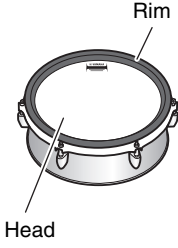
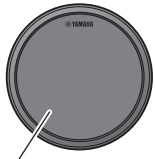
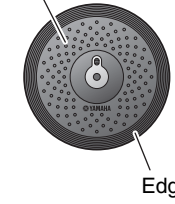
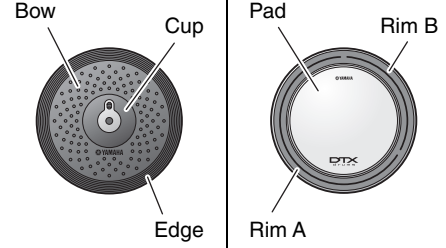
Pad Type	Multi Piezo	Single Piezo		
	2	1	2	3
Number of Zones	2	1	2	3
	Produces two different sounds (one for each zone)	Produces the same sound regardless of where the pad is struck. Also called the “monaural pads” or “1-zone pads.”	Produces two different sounds (one for each zone)	Produces three different sounds (one for each zone). Also referred to as “3-zone pads.”
Zone				
Example	XP125SD-X	TP70	RHH135	PCY135

### NOTE

For the information on the type of the drum sticks or beaters, refer to the Owner’s Manual for the pad.

## ■ Snare and Tom

Strike different sections of the pad in the same way you would play an acoustic snare drum or tom.

With the snare pad (the pad with position sensor connected to the [1 SNARE] jack), you can create natural tonal changes according to the location within the Zone.

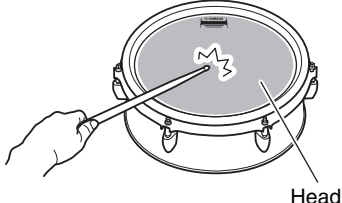
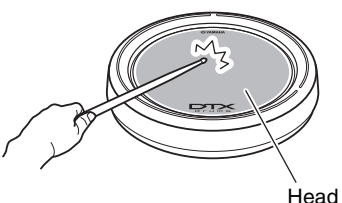
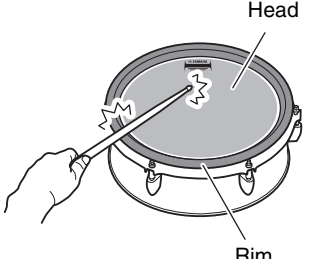
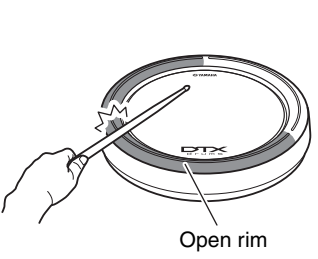
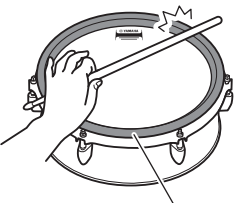
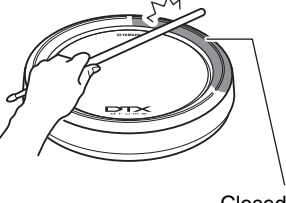
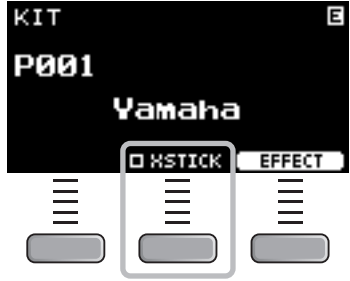
Head shots		
 <p>Head</p>	 <p>Head</p>	<p>Strike the main surface of the pad to produce a conventional head hit sound.</p> <p><b>Multi Piezo pad with position sensing:</b> With certain snare sounds, the sound changes depending on how far from the rim you strike.</p>
Open rim shots		
 <p>Head</p> <p>Rim</p>	 <p>Open rim</p>	<p>Strike the head and the rim at once to produce a rim shot sound.</p> <p><b>Multi piezo pads with position sensing:</b> You can use normal rim shots or shallow rim shots. Depending on the distance from the rim, the rim shot sound changes slightly.</p> <p><b>Single piezo 3-zone pads:</b> Strike the open rim.</p>
Closed rim shots, (cross sticking)		
 <p>Rim</p>	 <p>Closed rim</p>	<p>Strike only the rim. Do not touch the head.</p> <p><b>Multi piezo pads:</b> Press the button below "XSTICK" ([F2]) in the KIT screen to switch between on (for playing the cross-stick sound) or off (for playing the open rim shot sound).</p>  <p><b>Single piezo 3-zone pads:</b> Strike the closed rim.</p>



## ■ Hi-hats

Strike different sections of the pad in the same way you would play an acoustic hi-hat cymbal.

### Bow shots

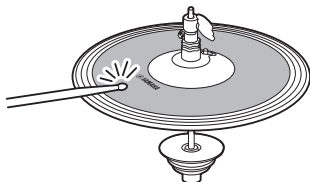

Striking the main surface of the hi-hat pad (i.e., the bow section located between the cup and edge) produces a bow shot sound.

### Edge shots

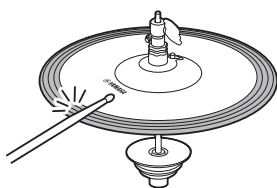

Striking the front side on the outer edge of the hi-hat pad produces an edge shot sound.

\*1

Make sure that the drumstick is parallel to the pad surface when striking the pad. The edge sensor switch on the cymbal pad may not react properly when the pad is struck completely from the side.

### Open/Close

- You can produce an open hi-hat sound by striking the hi-hat pad with the hi-hat pedal fully open.
- You can produce a closed hi-hat sound by striking the hi-hat pad with the hi-hat pedal fully pressed.
- Different hi-hat sound is produced depending on the how much the pedal is opened or pressed.

### Foot-close sounds

You can press down the hi-hat pedal to create a foot-close sound without having to strike the hi-hat pad.

### Hi-hat splash sounds

Pressing down the hi-hat pedal and then immediately releasing it produces a hi-hat splash sound.

\*1 The front side of the pad is indicated by the Yamaha logo.

## ■ Cymbals

Strike different sections of the pad in the same way you would play an acoustic cymbal. With the ride cymbal (the pad with position sensor connected to the [RIDE] jack), you can create natural tonal changes according to the location within the Zone.

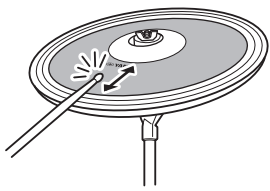
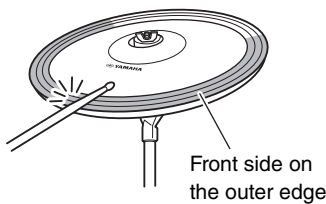
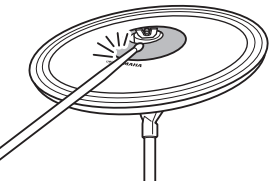
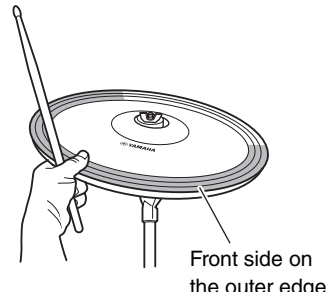
Bow shots	
	<p>Striking the main surface of the cymbal pad (i.e., the bow section located between the cup and edge) produces a bow shot sound.</p> <p>With the ride cymbal, strike the front side of the bow section, you can create natural tonal changes according to the location within the Zone.</p> <p>*1</p>
Edge shots	
	<p>Striking the front side on the outer edge of the cymbal pad produces an edge shot sound.</p> <p>*1</p> <p>Make sure that the drumstick is parallel to the pad surface when striking the pad. The edge sensor switch on the cymbal pad may not react properly when the pad is struck completely from the side.</p>
Bell shots	
	<p>Striking the bell (cup) produces a bell shot sound.</p>
Choking	
	<p>Grabbing the front side on the outer edge of a cymbal pad immediately after striking it will mute the sound being produced.</p> <p>*1</p>

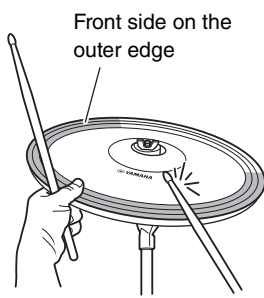
**Muting**

Striking the pad while holding the front side of the outer edge will produce a muted sound.

\*1

\*1 The front side of the pad is indicated by the Yamaha logo.

# Basic Operation of the DTX-PROX

## ■ Selecting a Kit

### 1. Set the Mode Select knob to “KIT.”

The KIT screen appears.

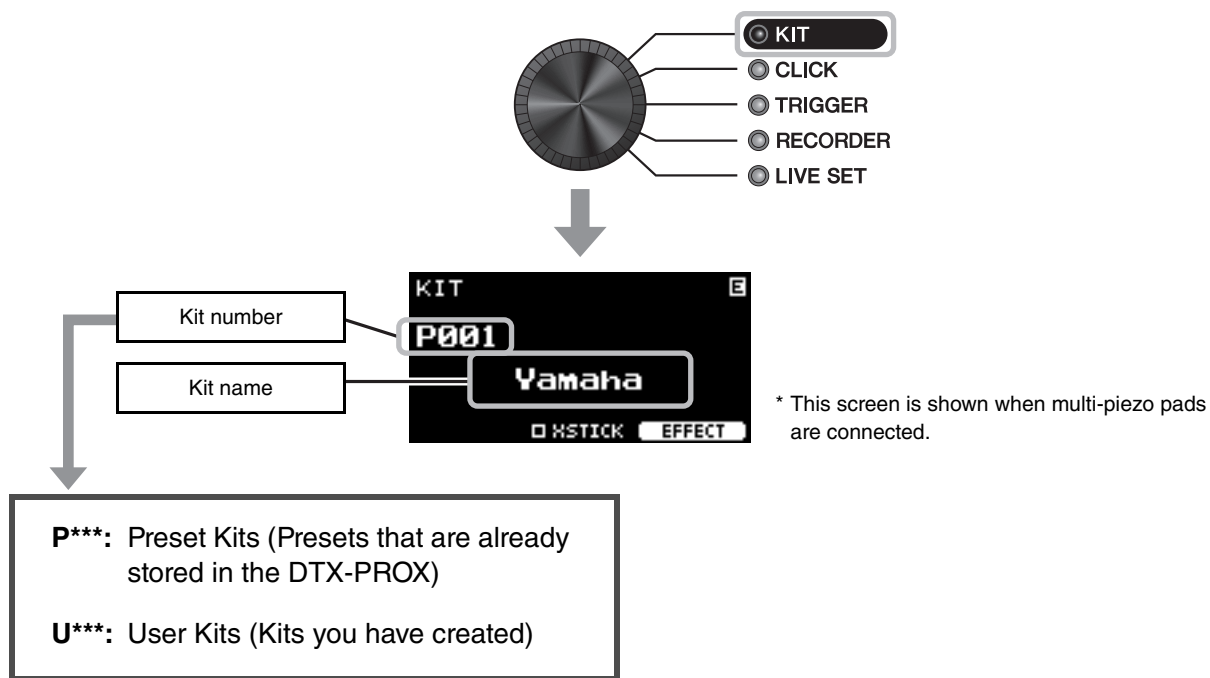

### 2. Use the [-][+] controllers to select a kit.

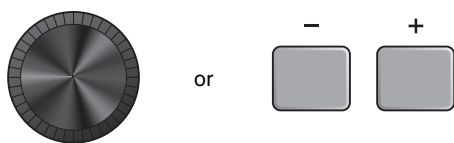

**NOTE**

If you've inadvertently selected another Kit before storing the Kit being edited, you can use the recall function to recall the edited contents. For more information, refer to the Reference Manual (PDF). (MENU/Job/Kit/Recall)

## ■ Adjusting (Modifying) the Sound Effects

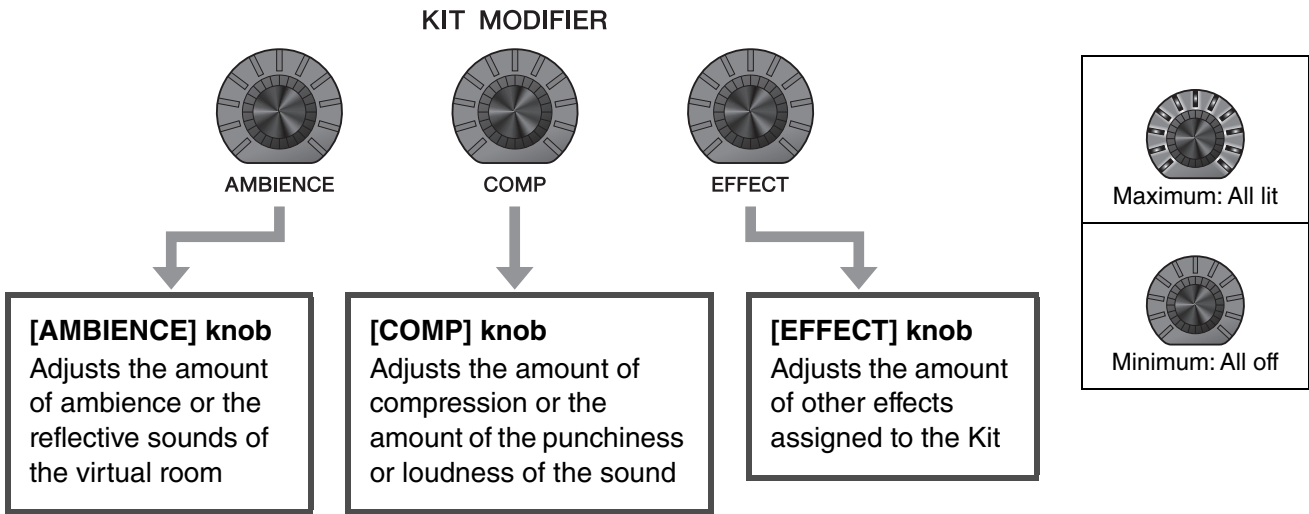

## ■ Changing the Effect Type to Apply

1. Press the button below “EFFECT” ([F3]).



2. Press the button below “EFFECT M...” ([F3]) to select the effect you wish to set.

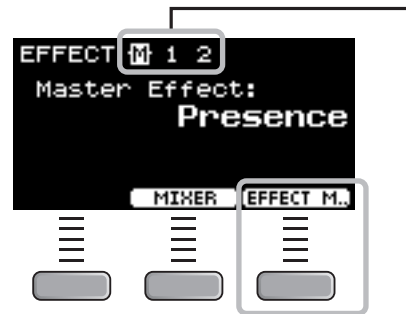

**Effect Selection**  
M: Master effect  
1: Effect 1  
2: Effect 2



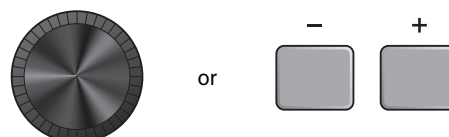

3. Use the [-] [+] controllers to select the effect type.

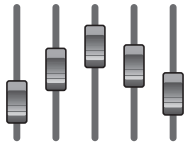
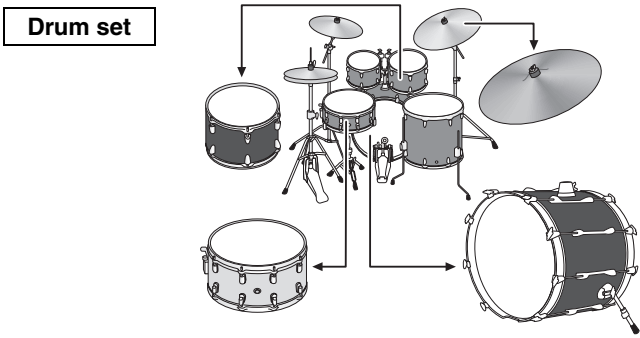

# Changing the Drum Set Sound (Building Your Own Drum Set)

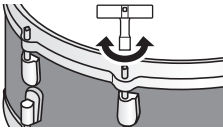
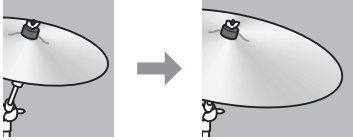
With the DTX-PROX, you can build your own drum set by changing the drum set sound within the Kit. By changing the settings shown below, you can customize the drum set sound.

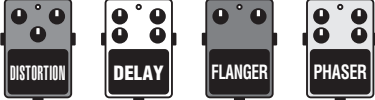
- **Adjusting the Audio Balance**  

- **Replacing Instruments**  

Drum set
- **Changing the Tunings**  

- **Changing the Cymbal Size**  

- **Muffling (muting) the drum**  

- **Sustain length of the cymbal**  
● **Hi-hat clutch positions, etc.**
- **Changing the Amount of Effect to Apply**  

- **Creating Custom settings**  

If you want to make more detailed changes to the settings, press the [MENU] button. For more information, refer to the Reference Manual (PDF). (MENU/Kit Edit/Inst or MENU/Kit Edit/Voice)

## ■ Adjusting the Audio Balance

Use the mixer to adjust the overall volume balance of the pads.

### NOTE

- The mixer setting is retained after switching to another Kit.
- The mixer setting is not saved as a Kit setting.

### 1. Set the fader select knob to “MIXER.”

The MIXER screen appears.

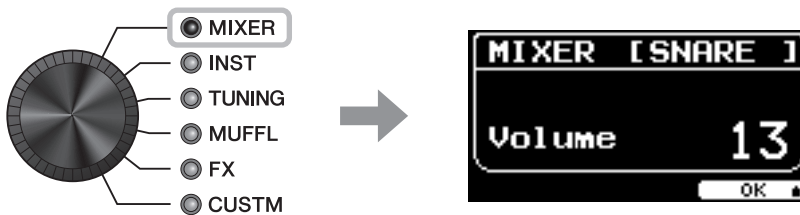

### 2. Use the LED rotary faders to adjust the settings.

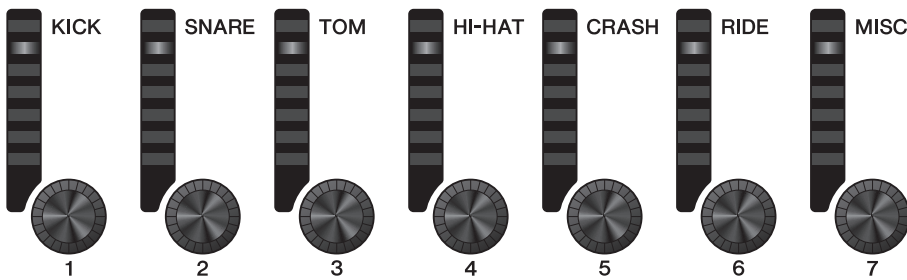

Shown on the panel	KICK	SNARE	TOM	HI-HAT	CRASH	RIDE	MISC
Pad	Kick	Snare	Tom1 Tom2 Tom3	Hi-Hat	Crash1 Crash2	Ride	Others
Trigger input jack the pad is connected to	12 KICK	1 SNARE	2 TOM1 4 TOM2 6 TOM3	1 HI-HAT	9 CRASH1 10 CRASH2	8 RIDE	3, 5, 7, 13, 14

To adjust the volume of each pad, press the [MENU] button to change the Inst volume settings.

To adjust the volume of each section of the pad (Zone), press the [MENU] button to change the Voice volume settings.

For more information, refer to the Reference Manual (PDF).

### 3. Press the button below “OK” (F3).

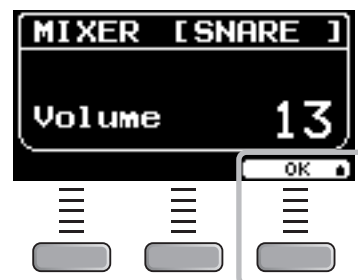

## ■ Replacing Instruments

### 1. Set the fader select knob to “INST”

The INST screen appears.

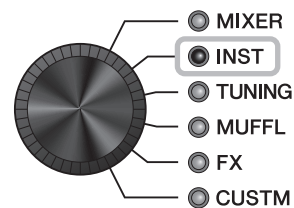

### 2. Strike the drum pad for which you wish to change the settings.

The pad name appears on the upper right corner of the screen.

**NOTE**

For the TOM, CRASH, and MISC pads, you can use the [PAD SELECT] button to change the pad selection. For more information, refer to the Reference Manual (PDF).

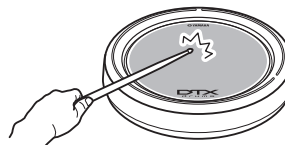



### 3. Use the LED Rotary Faders to select an Instrument.

The selected Instrument is shown on the screen.

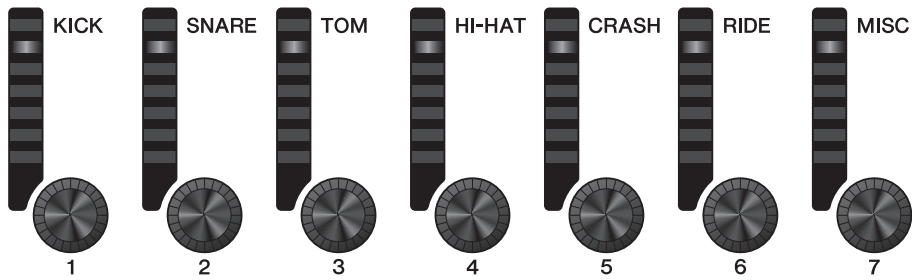

#### NOTE

For the TOM, CRASH, and MISC pads, you can use the [PAD SELECT] button to change the pad selection. For more information, refer to the Reference Manual (PDF).

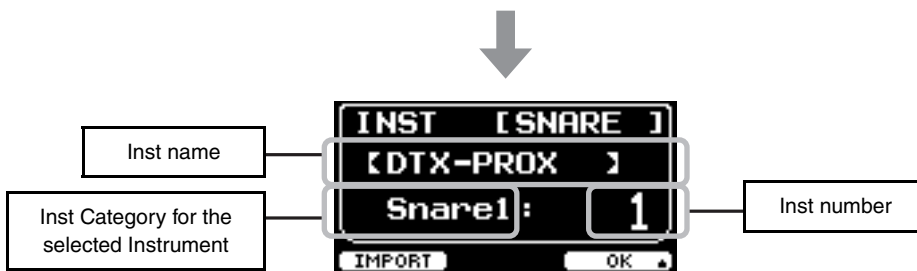

### 4. Press the button below “OK” (F3).

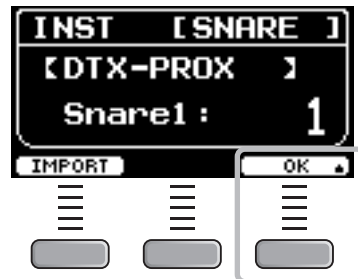

## ■ Using Imported Sounds (.wav)

You can import audio files (.wav) into the DTX-PROX to use as Inst sounds.

For more information on importing audio files and settings, refer to the Reference Manual (PDF).

For more information on using a USB flash drive, see “Using a USB Flash Drive” (page 21).

## ■ Changing Settings such as Tuning and Muffling (muting)

Inst settings such as tuning and muffling (muting) can be changed.

Settings that can be changed with TUNING or MUFL are different depending on the Inst Category.

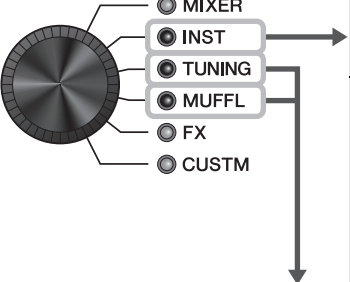

Inst Category for the selected instrument (INST)				
	Kick1 Kick2 Snare1 Snare2 Tom1 Tom2	Cymbal1 Cymbal2	HiHat1 HiHat2	Perc Effect User
<b>TUNING</b>	Tuning Determines the tuning (pitch).	Size Simulates the effect of changing the cymbal size.	Size Simulates the effect of changing the cymbal size.	Tuning Determines the tuning (pitch).
<b>MUFL</b>	Muffling Simulates the effect of changing the degree of muffling (or how much the drum head is muted)	Sustain Determines the cymbal's sustain time (i.e., how quickly the sound decays to silence).	Clutch Simulates the effect of changing the hi-hat's clutch position. The smaller the setting, the quicker an open hi-hat sound will decay to silence.  <b>NOTE</b> Hi-Hat Clutch setting is applied to all Kits.	Decay Determines how quickly the sound decays to silence.

### 1. Set the fader select knob to “TUNING” or “MUFL.”

The setting screen appears.



## 2. Use the LED Rotary Faders to adjust settings.

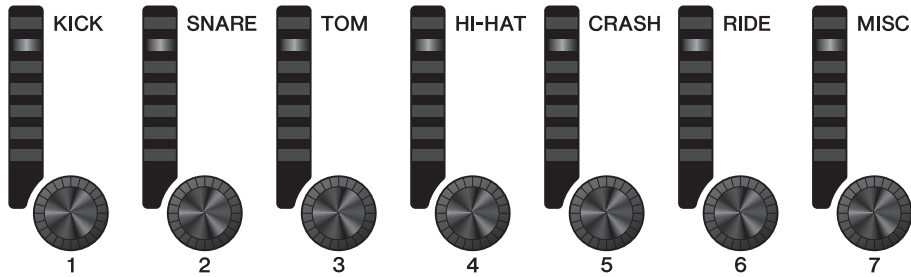

## 3. Press the button below “OK” (F3).

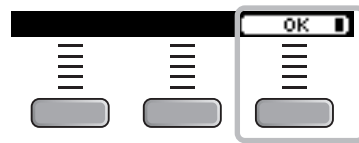

## ■ Changing the Amount of Effect Applied to each Instrument

The amount of effects (such as Effect1, Effect2, Transient) can be set independently for each Inst.

For example, you can use these settings to apply deeper effects only to the snare.

For more information, refer to the Reference Manual (PDF).

## ■ Creating Custom settings

Other settings such as Master EQ, Phones EQ gain, volume of the individual click timing, and the send settings on MIDI control change can be customized. For more information, refer to the Reference Manual (PDF).

### NOTE

- The CUSTM setting is retained after switching to another Kit.
- The CUSTM setting is not saved as a Kit setting.

## ■ Saving a Customized Kit under a New Name

### 1. Press the [STORE] button.

The KIT STORE screen appears.

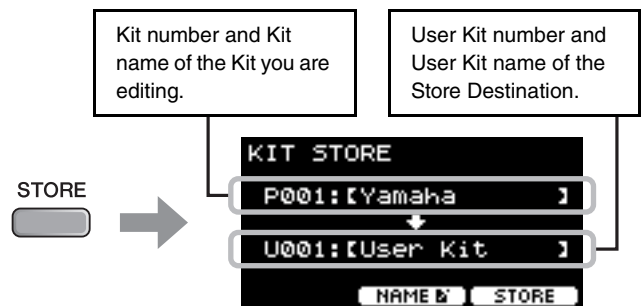

### 2. Press the button below "NAME" ([F2]) to open the NAME screen.

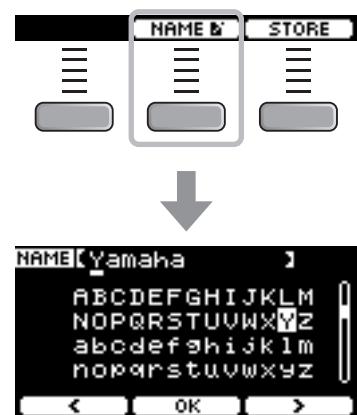

### 3. Use the buttons below "←" and "→" ([F1] and [F3]) to select the character position, then use the [-] [+] controllers to select a letter.

A name of up to 12 characters can be set to the Kit.

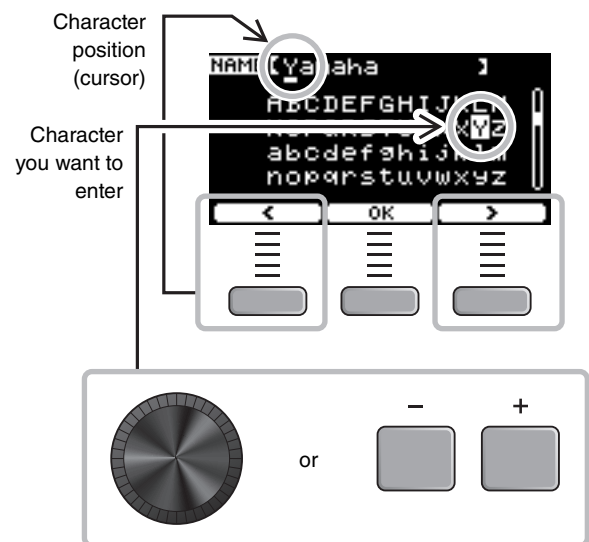

4. After entering all characters, press the button below “OK” ([F2]) and return to the STORE screen.



5. Use the [-] [+] controllers to select a User Kit Number to store your Kit to.

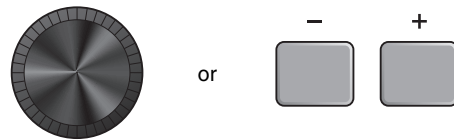

6. After confirming the new Kit Number and Kit Name, press the button below “STORE” ([F3]).

**NOTE**

You cannot save an edited Kit to a Preset Kit.

**NOTICE**

When overwriting a Kit, the current Kit settings are replaced with the new settings. Before overwriting a Kit, ensure that the Kit contains no irreplaceable settings.

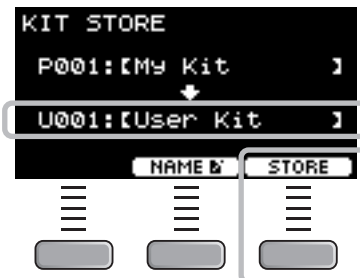

“Overwrite?” appears when the selected Kit Number already contains a Kit.  
 If you want to overwrite to save the Kit, press the button below “YES” ([F1]).  
 If you do not want to overwrite, press the button below “NO” ([F3]) and return to the previous screen where you can select another Kit number.

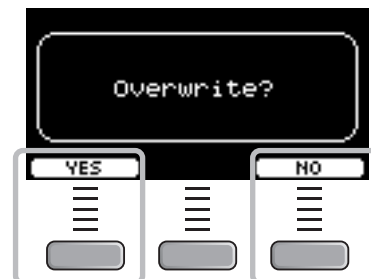

When the Kit operation is complete, the display returns to the Kit screen.

# Using the Click (Metronome)

Practicing your drumming along with the click (metronome) sounds helps you perfect your rhythms.

## ■ Starting and Stopping the Click

### 1. Press the [CLICK] button to start the Click.

Click sounds are played at the tempo shown in the Click Tempo display.

The lamp next to the [CLICK] button flashes in sync with the tempo while the Click sounds.



### 2. To stop the click, press the [CLICK] button again.

## ■ Changing the Tempo

### 1. Turn the [TEMPO] knob.



## ■ Setting the Click Beat Volume

### 1. Move the [CLICK] slider.

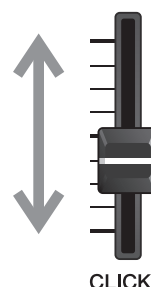

# Creating Your Own Click (Metronome) Settings

Set the Click (metronome) tempo, volume, etc.

## 1. Set the Mode Select knob to "CLICK."

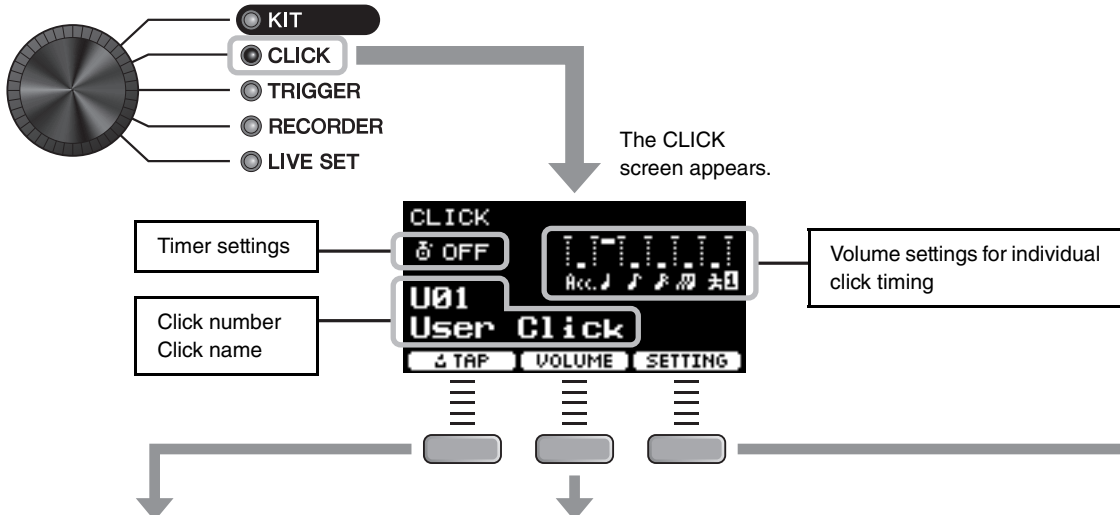

### Setting the Tempo by Tapping the Button (Tap Tempo)

Tap the button at the desired tempo to set the tempo.

**2. Press the button below "TAP" ([F1]).**

The TAP screen appears.

**3. Tap the button below "TAP" ([F3]) at least 3 times.**

The tapped tempo is detected and appears on the Click tempo display.

**NOTE**  
You can also set the tempo by striking a pad connected to the Trigger Input jacks.

### Changing the Volume of the Individual Click Timing

**2. Press the button below "VOLUME" ([F2]).**

The VOLUME screen appears.

ACC	Accents
♩	Quarter notes
♪	Eighth notes
♫	Sixteenth notes
♬	Eighth note triplets
♫	Human voice

3/8, 6/8, 9/8, 12/8, 15/8 beats only have settings for Acc, dotted quarter, eighth, and sixteenth notes.

Press the button below "1 2" ([F3]) to switch between Human voice1 and Human voice2 to change counts.

**3. Use the buttons below "◀" and "▶" ([F1] and [F2]) to move the cursor and use [-][+] to change the volume.**

### Changing Other Settings

Beat, Timer settings, click sound types, and other settings can be changed. Also, you can use your choice of a wav file as click sound. For more information, refer to the Reference Manual (PDF).

## ■ Saving the Customized Click Setting under a New Name

The Click settings you have customized can be saved in the same way as saving a kit. See “Saving a Customized Kit under a New Name” (page 40).

## ■ Using Saved Click Settings

While the CLICK screen is shown on the display, use the [-][+] controllers to select a user click.

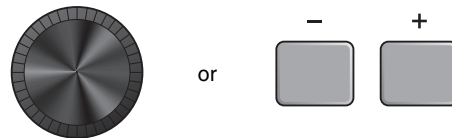



## Changing the Trigger Settings

With the Initial setup (Trigger Setup Wizard), the DTX-PROX will automatically optimize the trigger output levels for all pads. You can adjust each of settings later or create a new Trigger setup. Several sets of customized trigger setups can be saved on the DTX-PROX.

### NOTE

The setting selected with the Trigger Setup Wizard appears as the first setting shown on the screen.

### ■ Creating a customized trigger setup

Trigger setups can be changed from the button below “SETTING” ([F3]). For more information, refer to the Reference Manual (PDF).

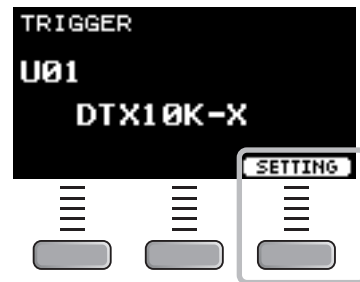

### ■ Saving the customized trigger setup

The Trigger setups you have customized can be saved in the same way as saving a kit. See “Saving a Customized Kit under a New Name” (page 40).

### ■ Selecting a Trigger setup

#### 1. Set the Mode Select knob to “TRIGGER.”

The TRIGGER screen appears.

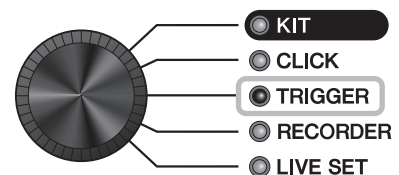

#### 2. Select the desired Trigger setup with the [-][+] controllers.

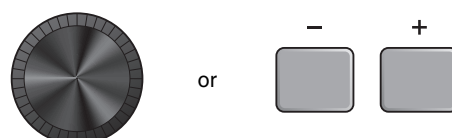

# Recording Your Performance

Use the DTX-PROX to record your performance. When a USB flash drive is connected to the DTX-PROX, audio is recorded to the USB flash drive.

You can overdub your performance onto an accompaniment song (input via the [AUX IN] jack or *Bluetooth*) and save your performance combined with the accompaniment song as a single audio file.

## ■ Recording to the DTX-PROX (when no USB flash drive is connected to the terminal)

### 1. Set the Mode Select knob to “RECORDER.”

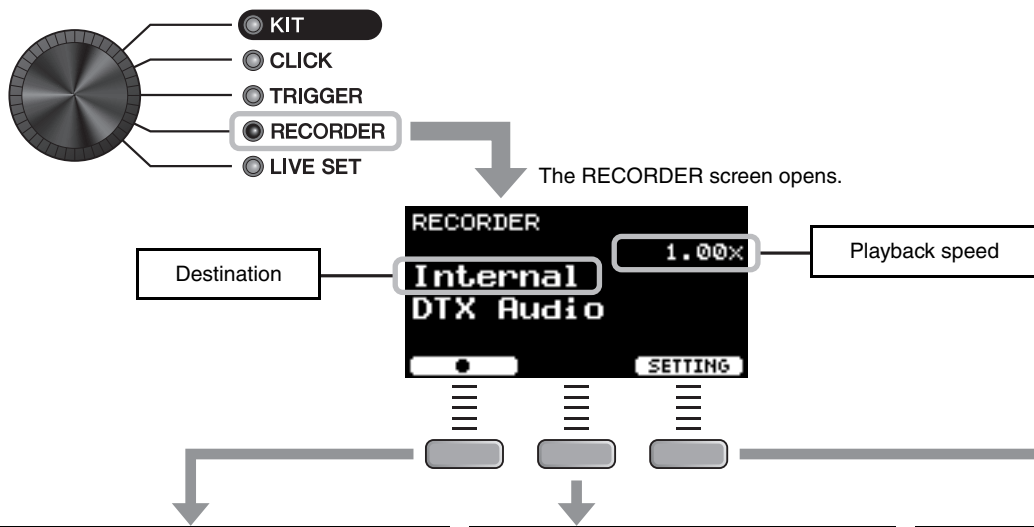

### Recording

Recording time to the DTX-PROX is about 1 minute 30 seconds.

**2. Press the button below “●” ([F1]) to start recording.**

While recording, the elapsed recording time (min: sec) appears.

**3. Play the drums.**

**4. After you finish playing, press the button below “■” ([F1]) to stop recording.**

### Playing Back

**NOTE**  
This is not displayed when there is no recorded song.

**2. Press the “▶” button ([F2]) to start playback.**

While playing back, the elapsed playback time (min: sec) appears.

**3. To stop playback, press the “■” button ([F2]).**

### Changing other settings

Other settings such as the playback speed or the recording source can be changed. For more information, refer to the Reference Manual (PDF).

**NOTICE**

- When your performance is already recorded on the DTX-PROX, recording again on the DTX-PROX erases the previous recording.
- Any performance recorded to the DTX-PROX will be lost when the power is turned off. If you wish to save your recordings, export the recorded data as audio files. For more information, refer to the Reference Manual (PDF). (MENU/Job/Recorder/Export Audio)

## ■ Recording to a USB Flash Drive

### 1. Connect a USB flash drive to the [USB TO DEVICE] terminal on the rear panel.

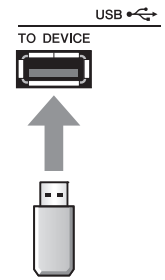

#### When a USB flash drive is connected

- You can record up to 90 minutes at a time.
- A new file is created every time you record.
- Simultaneous playback and recording to overdub your performance onto the currently playing song.

### 2. Set the Mode Select knob to “RECORDER.”

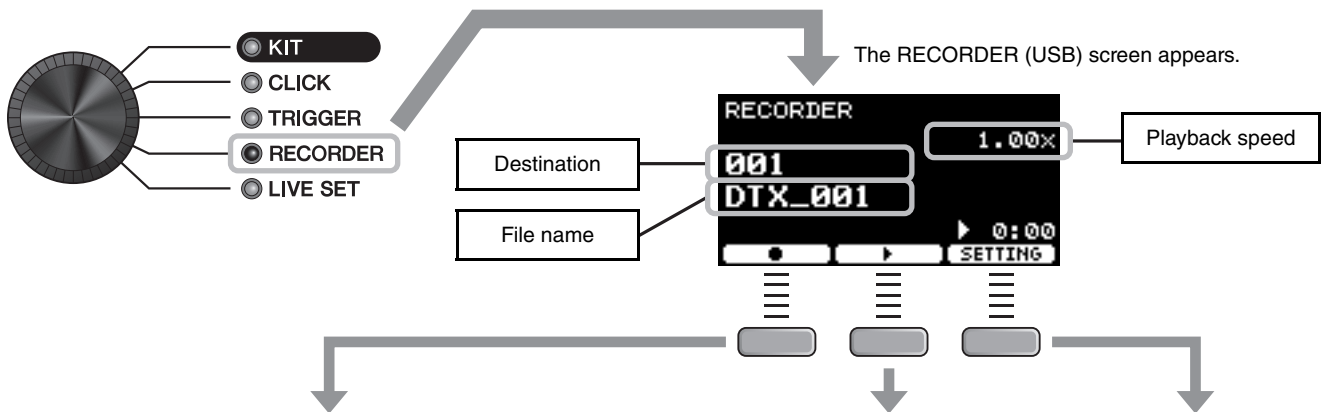

#### Recording

**3. Press the button below “●” ([F1]) to start recording.**

While recording, the elapsed recording time (min: sec) appears.

**4. Play the drums.**

**5. After you finish playing, press the button below “□” ([F1]) to stop recording.**

The RECORDER SAVE screen appears.

**6. Press the button below “SAVE” ([F3]) and save the file.**

Press the button below “CANCEL” ([F2]) if you do not want to save the file.

**NOTE**  
If you want to change the file name, press the button below “NAME” ([F1]) and enter a new name. (page 40)

#### Playing Back

**NOTE**  
This is not displayed when there is no recorded song.

**3. Use the [-][+] controllers to select a song for playback.**

**NOTE**  
Up to 1,000 songs are recognized.

**4. Press the button below “▶” ([F2]) to start playback.**

**5. Press the button below “■” ([F2]) to stop playback.**

#### Changing Other Settings

Other settings such as the playback speed or the recording source can be changed. For more information, refer to the Reference Manual (PDF).

## ■ Overdub Recording Your Performance onto an Accompaniment Song

You can also overdub your performance onto an accompaniment song that you've imported onto a USB flash drive and save your performance combined with the accompaniment song as a single audio file.

### ● Preparing an Accompaniment Song (Audio File)

#### • Importing from a Computer

Save the audio file (.wav file) from the computer to the root directory on a USB flash drive.

**Audio file requirements:** 16-bit, 44.1 kHz, stereo, wav format

**NOTE**

- Some of the audio files may not play back even when the above requirements are met.
- The DTX-PROX does not recognize the audio file if it is in a folder.

### ● Recording Yourself Playing Along with the Accompaniment Song

1. Use the [-] [+] controllers to select the accompaniment you have prepared.

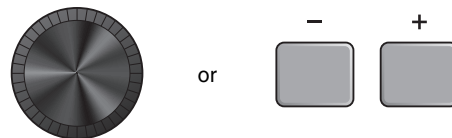

2. Press the button below “●” ([F1]) and the button below “▶” ([F2]) to start recording and playback.

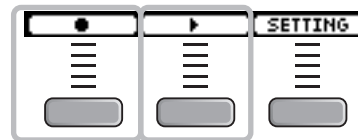

3. Play the drums.

4. After you finish playing, press the button below “□” ([F1]) to stop recording.

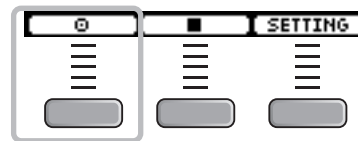

**NOTE**

Pressing the button below “■” ([F2]) stops accompaniment playback, but recording continues.

## Connecting a PA System

When sending the DTX-PROX sounds to a mixer for live performance or other applications, connect the PA system as follows:

### Example connection

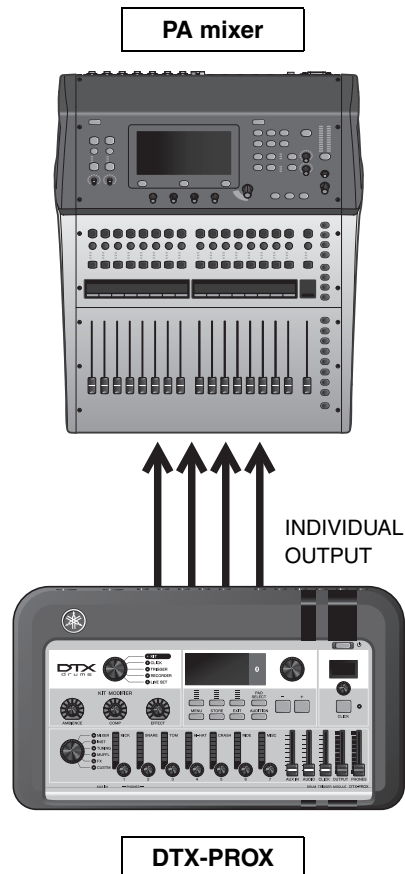

### ■ [INDIVIDUAL OUTPUT] jacks (1/2 to 7/8)

Output the sound of each instrument, such as snare and kick.

- Stereo standard phone jack (UNBALANCED)
- Up to 8 mono outputs (or 4 stereo outputs)
- Any sounds (such as pad sounds, and click) can be assigned independently to the outputs

To split one stereo output into two mono outputs, use a commercially available Y-cable.

The routing settings can be changed. For more information, refer to the Reference Manual (PDF).

# Using Live Sets

A Live Set is a combination of the Kit, tempo, audio files and other settings sequenced in the order you like. For example, you can create a chain of Kits in the order of a performance set list when playing live, or arrange a series of audio files in the order of difficulty level for use in your daily practice.

With the DTX-PROX, you can save up to 10 Live Sets, and use them anytime during your performance.

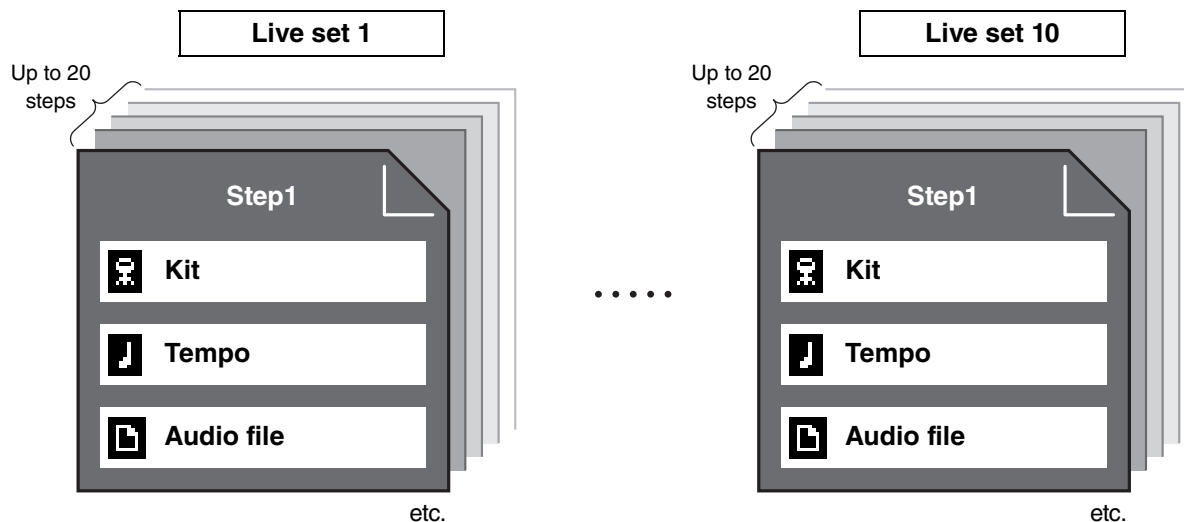

## ■ Creating a Live Set

You can create a Live Set by registering the combination for each Step. For more information, refer to the Reference Manual (PDF).

# Application Guide

## Connecting Separately Sold Add-ons and External Devices

You can connect add-ons (sold separately) and external devices to the DTX-PROX to access more functions of the DTX-PROX.

### About the Trigger Input Jacks

Trigger Input jacks are used for connecting pads. The [1] SNARE to [14] jacks on the rear panel accept up to 14 pads. For more information on the types of pads you can use, see “Playing the Pads” (page 27).

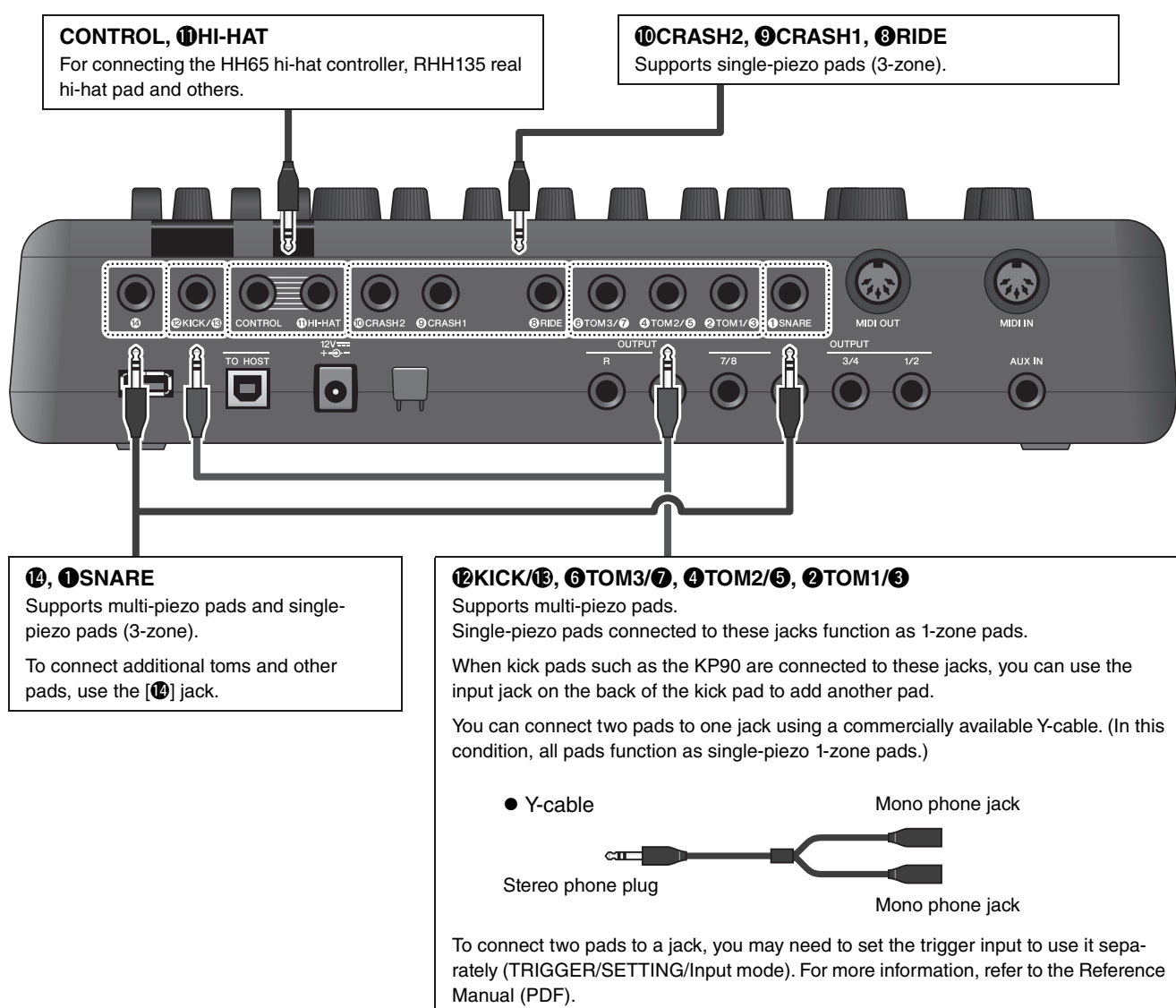

For information on the voice assignment of trigger inputs, refer to the Data List (PDF).

For more information on the separately-sold accessories that can be connected to each trigger input jack, refer to the Pad Module Compatibility table available on the website shown below.

Yamaha Downloads: <https://download.yamaha.com/>

\* Yamaha Corporation reserves the right to modify this URL at any time without prior notice.

## ■ Integrating Separately Sold Accessories

You can expand your electronic drum kit with various accessories\* for an even more enjoyable drumming experience.  
 (\*: sold separately)

The following describes how to connect a XP125T-X or a PCY95AT. For the information on the compatibility of other pads, refer to the Pad Module compatibility table (PDF). <https://download.yamaha.com/>

### ● Adding a tom to the [14] jack

1. Turn off the drum trigger module.
2. Connect the XP125T-X to the [14] jack.

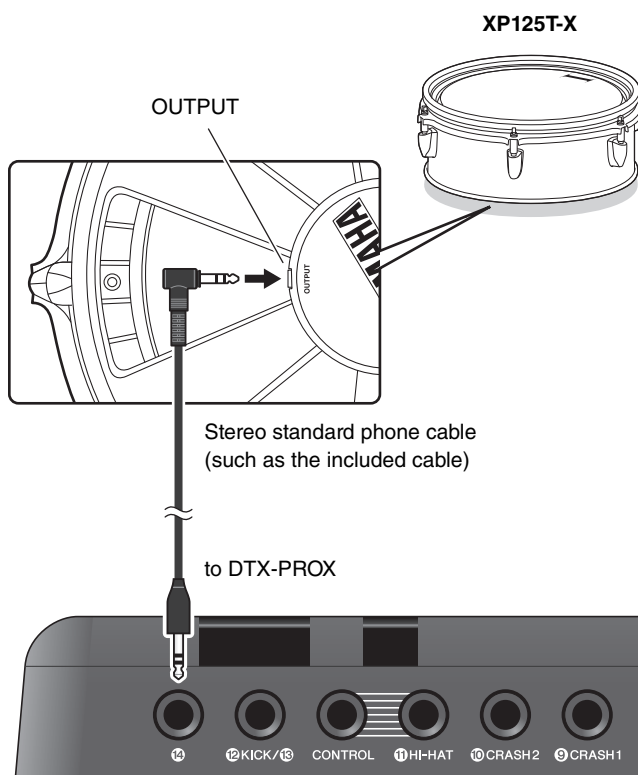

3. Turn on the drum trigger module.
4. Choose the correct pad type for the XP125T-X.  
 (TRIGGER/SETTING/Pad Type)

### ● Adding a cymbal to the [2TOM1/3] jack

By attaching a commercially available Y-cable to the [2TOM1/3] jack, you can connect an additional cymbal. In that condition, those two pads connected to the same jack function as single-piezo 1-zone pads.)

1. Turn off the drum trigger module.
2. Connect a commercially available Y-cable and a pad to the [2TOM1/3] jack.

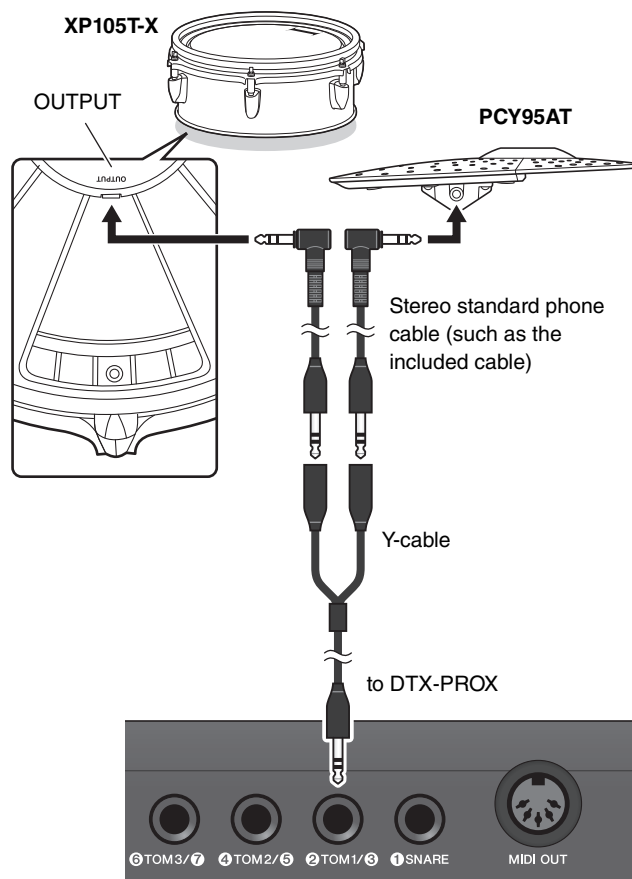

3. Turn on the drum trigger module.
4. Set the Pad Type to “PCY95AT.”  
 To split the trigger input, set the Input Mode to “separate.”  
 (TRIGGER/SETTING/input mode)



## ■ Integrating Electronic & Acoustic Drums

The following describes a couple of examples of how you can integrate electronic and acoustic drums.

### ● Adding Pads to an Acoustic Drum Set

You can easily add a pad such as the XP125SD-X to an acoustic drum set. Set the proper Pad Type for the connected pad (TRIGGER/SETTING/Pad Type).

#### ● Typical setup

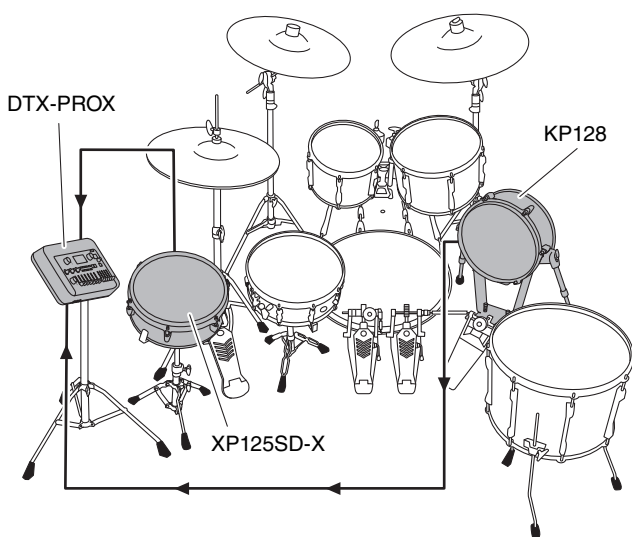

### ● Playing the DTX-PROX Using Acoustic Drums

You can attach a DT50K or DT50S Drum Trigger to the bass drum or the snare drum and connect to the [12 KICK/13] jack or the [1 SNARE] jack on the DTX-PROX to send trigger signals to your drum trigger module whenever the drum is struck. After connecting cables, set the pad type parameter. (TRIGGER/SETTING/Pad Type)

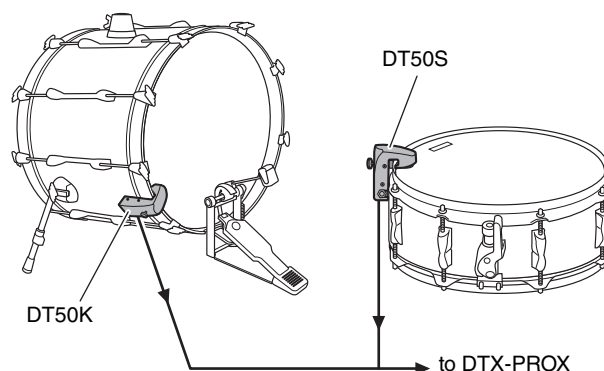

For more information on how to attach the Drum Trigger, refer to the DT50S/DT50K Owner's Manual.

#### ● Typical setup (for attaching the Drum Triggers to the snare and the bass drum)

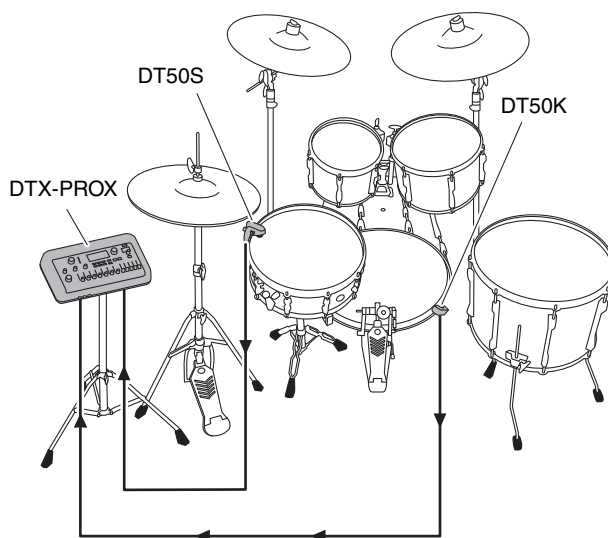

## ■ Connecting a Computer

You can connect the DTX-PROX to a computer and use DAW (Digital Audio Workstation) software such as the included Cubase AI to record your performance, edit, or mix audio.

For more information on how to connect a computer, refer to the Reference Manual (PDF). For more information on how to use the DAW software, refer to the Owner's Manual for your DAW software.

### Precautions when using the [USB TO HOST] terminal

When connecting the computer to the [USB TO HOST] terminal, make sure to observe the following points to avoid freezing the computer and corrupting or losing the data.

#### NOTICE

- Use an AB type USB cable of less than 3 meters. USB 3.0 cables cannot be used.
- Execute the following before turning the power to the instrument on/off or plugging/unplugging the USB cable to/from the [USB TO HOST] terminal.
  - Quit any open application software on the computer.
  - Make sure that data is not being transmitted from the instrument.
- While the computer is connected to the instrument, you should wait for six seconds or more between these operations: (1) when turning the power of the instrument off then on again, or (2) when alternately connecting/disconnecting the USB cable.

If the computer or the instrument freezes, restart the application software or the computer OS, or turn the power to the instrument off then on again.

# Reference

## Message List

Message	Description
Are you sure?	Confirms whether or not you want to run the specified operation.
Auto power off disabled.	Appears when the [MENU] button is held down while turning on the power informing the user that the Auto Power Off function is disabled.
Backup error.	Appears when writing data to the DTX-PROX has failed. If data was not be properly saved when turning off the unit, this message appears the next time the power is turned on. After the error message appears, the Factory Reset is carried out automatically.
<i>Bluetooth</i> pairing....	Waiting for <i>Bluetooth</i> devices to pair. (page 24)
Canceled.	Appears when the cancel operation is complete.
Can't process.	The DTX-PROX cannot process a requested operation.
Completed.	Appears when a Kit Store, File Load/Save, Job, or other function is complete.
Connecting USB device...	Appears when connecting to a USB device.
Excessive demand for USB power.	Power consumption of the USB device exceeds the specified value.
Factory Reset initializing...	Appears on startup if you did a factory reset.
File already exists.	A file with the same name already exists.
File not found.	The selected file type was not found.
Illegal file.	Appears when loading a file and the DTX-PROX cannot handle the target file or does not support the audio file.
Incompatible USB device.	Appears when an unsupported USB device is connected to the [USB TO DEVICE] terminal.
Invalid USB device.	The USB device is faulty. Format the USB device again.
Keybank full.	Appears when the total number of keybanks for waveforms have exceeded the maximum capacity.
No data.	Appears when the target data does not exist when using the Recorder or using Wav-related parameters under "Job."
No response from USB device.	There is no response from the USB device.
Now importing...	Appears when importing a .wav file.
Now loading...	Appears when loading a file.
Now processing...	Appears when running the Kit Store or Job operation. Appears during post-processing after canceling the File Load or File Save operation.
Now saving...	Appears when saving a file.
Overwrite?	Appears when saving a file to the USB device and a file with the same name already exists in the USB device. Appears when attempting to rerun the Store User Kit operation for the Kit previously saved.

### Message List

Message	Description
Please stop recorder.	Appears when performing an operation that exits the Recorder during recorder playback or recording. Stop the Recorder and try again.
Recording time limit exceeded.	Appears when the recorder has reached the time limit. Recording time is about 1 minute 30 seconds with internal memory, and about 90 minutes with a USB flash drive. This message also appears when the USB flash drive has reached its capacity during recording.
Read only file.	Appears when a read-only file is selected during a file operation.
Sample is too long.	Sample is too long and cannot be loaded.
Sample is too short.	Sample is too short and cannot be loaded.
Song is too long.	The song file is too large and cannot be loaded.
USB connection terminated.	Appears if connection with the USB device was interrupted by an abnormal electric current. Disconnect the USB device and press the button below "OK".
USB device's transfer speed too slow.	Appears when the transfer speed to the USB device is insufficient. For information on devices that have been tested and confirmed to work properly with the DTX-PROX, refer to the "Compatible USB Device List" on the Yamaha web site.
USB device full.	Appears when the USB device is full and files cannot be saved on it. Use a new USB device or make space by erasing unnecessary files from the full device.
USB device not ready.	Appears if the USB device is not properly connected to the DTX-PROX.
USB device read/write error.	Appears if an error occurred while reading or writing data to the USB device.
USB device write protected.	Appears if the USB device is write-protected.
USB transmission error.	Appears if an error occurred while communicating with the USB device.
User Voice full.	Appears when the total number of User voices have exceeded the maximum capacity.
Waveform full.	Appears when the total number of waveforms have exceeded the maximum capacity.
Wave memory error.	Appears when loading data to the Wave memory has failed. When the Wave data was not saved properly, this message appears the next time the DTX-PROX is turned ON. After this message appears, the recovery process starts automatically.
Wave memory full.	Appears if the WAVE memory is full and operations such as Import, Job, or Load cannot be carried out.

## Troubleshooting

For more troubleshooting tips, refer to the Reference Manual (PDF).

See page 7 for details on downloading this manual.

Symptom		Possible cause	Solution	Reference page
No sound Out of balance	No sound	The cable is not properly connected	<ul style="list-style-type: none"> <li>• Ensure that the DTX-PROX is properly connected to headphones or an external audio system, such as an amplifier and/or speakers.</li> <li>• Ensure that the cables you are using are in good condition.</li> </ul>	page 12 page 13 page 16
		The volume or level settings are improper The headphone volume is not turned up The metronome volume is not turned up	Check the following: <ul style="list-style-type: none"> <li>• Volume controllers on amplifiers and/or speakers connected to the DTX-PROX.</li> <li>• Sliders ([OUTPUT], [PHONES]) on the DTX-PROX top panel.</li> <li>• LED rotary faders</li> <li>• Volume for the metronome (Click) ([CLICK] slider).</li> <li>• The trigger output level of any pads with a dial allowing this to be adjusted.</li> </ul>	page 10 page 13
	Poor volume balance	Poor volume balance between each of the pads	Ensure that the LED rotary faders have been set appropriately.	page 35
		Poor volume balance between the external audio device and the DTX-PROX	<ul style="list-style-type: none"> <li>• Individually adjust the output volumes of the DTX-PROX and the external audio devices.</li> <li>• Adjust the volume with the [AUDIO] slider.</li> </ul>	page 10 page 13 page 24
	Poor EQ balance	Poor EQ balance	<ul style="list-style-type: none"> <li>• Adjust the Phones EQ and the Master EQ.</li> </ul>	page 16 page 39
	Pads with position sensing do not produce sounds properly		<ul style="list-style-type: none"> <li>• Ensure that the Pad Type and trigger parameters have been set correctly. (For more information, refer to the "Reference Manual" (PDF).)</li> <li>• Check the orientation of the cymbal pad. When this is not set properly, the cymbal pad may not be fully functional.</li> <li>• Make sure to connect the pad to the proper jack that supports position sensing.</li> </ul>	page 27 Assembly Manual
	Headphone volume is too low		<ul style="list-style-type: none"> <li>• Adjust the values in MENU/Utility/Output Gain.</li> <li>• Use one headphone at a time. Using two at once may reduce the output level.</li> </ul>	Reference Manual (PDF) page 16

Symptom	Possible cause	Solution	Reference page
<p>Having difficulties during performance</p> <p>Cymbal/Hi-hat sounds are too soft</p> <p>The DTX-PROX produces sound but the sensitivity (i.e., volume) is too low.</p>	<p>Orientation of the cymbal pad is incorrect</p> <p>Shaft on the Hi-hat pad is loose</p> <p>Extra felt is attached</p> <p>The pad type or trigger parameter setting is incorrect</p> <p>LED rotary fader is set at the minimum level</p> <p>The level settings for the pad are improper</p>	<ul style="list-style-type: none"> <li>• Check the orientation of the cymbal pad. When it is improper, the cymbal pad may not be fully functional.</li> <li>• The shaft on the hi-hat stand may come loose during use and cause the hi-hat pad to rotate. If this happens, the pad may not function properly. To avoid the problem, we recommend that you tighten the shaft and check the position of the hi-hat pad on a regular basis.</li> <li>• Putting extra felt under the cymbal pad may result in lower volume.</li> <li>• Ensure that the Pad Type parameter is set correctly. (A suitable cymbal-pad type must be selected for the pad being used. (For more information, refer to the "Reference Manual" (PDF).)</li> <li>• The trigger output level of any pads with a dial allow this to be adjusted.</li> <li>• Ensure that the LED rotary fader for the pad for which a sound is not being produced is set high enough.</li> </ul>	<p>page 27 Assembly Manual</p> <p>page 35</p>
<p>Sound is produced without striking the pad</p> <p>Sound is produced by a pad that was not struck (Crosstalk is occurring)</p>		<p>For more information, refer to the "Reference Manual" (PDF).</p>	<p>Reference Manual (PDF)</p>
<p>Cannot choke</p> <p>Cannot mute</p>		<p>Check the orientation of the cymbal pad. When the orientation of the pad is improper, the cymbal pad may not function fully.</p>	<p>page 27 Assembly Manual</p>
<p>Foot closed hi-hat sounds cannot be played</p> <p>It is difficult to produce closed hi-hat sounds</p>	<p>Shaft on the Hi-hat pad is loose</p> <p>Extra felt is attached</p> <p>LED rotary fader is set at the minimum level</p> <p>The level settings for the pad are improper</p>	<ul style="list-style-type: none"> <li>• Make sure that you are fully and firmly operating the hi-hat pedal.</li> <li>• Ensure that the foot controller is correctly connected to the [CONTROL] jack.</li> <li>• Putting extra felt under the cymbal pad may result in lower volume.</li> <li>• Ensure that the LED rotary fader for the pad for which a sound is not being produced is set high enough.</li> </ul>	<p>Assembly Manual</p> <p>page 35</p>
<p>Pads with position sensing do not produce sounds properly</p>		<ul style="list-style-type: none"> <li>• Ensure that the Pad Type and trigger parameters have been set correctly. (For more information, refer to the "Reference Manual" (PDF).)</li> <li>• Check the orientation of the cymbal pad. When this is not set properly, the cymbal pad may not be fully functional.</li> <li>• Make sure to connect the pad to the proper jack that supports position sensing.</li> </ul>	<p>page 27 Assembly Manual</p>

Symptom	Possible cause	Solution	Reference page
Settings	The drum module does not store its settings	<p>The drum module automatically stores its system settings whenever you turn it off using the [⏻] (Standby/On) button.</p> <ul style="list-style-type: none"> <li>Do not turn off the drum module by unplugging the AC adaptor. This will prevent it from storing the system settings.</li> <li>User settings for kits, click sets, and triggers must be stored manually.</li> </ul>	<p>page 18 page 15 page 40</p>
	Data cannot be saved on a USB flash drive	<p>USB 1.1 compatible flash drives cannot be used on the DTX-PROX.</p> <ul style="list-style-type: none"> <li>Ensure that the USB flash drive in question has been formatted using the DTX-PROX.</li> <li>Ensure that the USB flash drive in question has not been write-protected.</li> <li>Ensure that there is sufficient free space on the USB flash drive to save the data. (For more information, refer to the "Reference Manual" (PDF).)</li> </ul>	Reference Manual (PDF)
	Cannot send data to or from the smart device	Check the connection. For more information, refer to the iPhone/iPad Connection Manual or Smart Device Connection Manual for Android™.	page 23
	The <i>Bluetooth</i> -equipped smart device cannot be paired with nor connected to the instrument.	<ul style="list-style-type: none"> <li>Check the <i>Bluetooth</i> function of the smart device is activated. To connect the smart device and the instrument via <i>Bluetooth</i>, both devices need to be functional.</li> <li>The smart device and the instrument need to be paired (page 24).</li> <li>In case there is a device (microwave oven, wireless LAN device, etc.) that outputs signals in the 2.4 GHz frequency band nearby, move this instrument away from the device that is emitting radio-frequency signals.</li> </ul>	page 24
	Power turns off unexpectedly	Disable the Auto Power-Off function.	page 19
	The DTX-PROX does not receive any switch or trigger signals at all  I want to reset the DTX-PROX to the factory default	Use the Factory Reset to restore the settings to the factory defaults.	page 20

# Specifications

Tone generator	Type	AWM2	
	Maximum polyphony	256 notes	
	Effect units	For each Inst EQ / Comp / Transient / Insertion (*1)  For each Kit Ambience / Effect 1 / Effect 2 Master Comp / Master Effect  For overall Master EQ / Phones EQ  (*1) Insertion effects can be used only for specific Inst.	
Kits	Quantity	Preset: more than 40 kits User: 200 kits	
	Number of voices	Drum/Percussion: more than 400	
Metronome	User click sets	30	
	Tempo	30 to 300 BPM; tap tempo supported	
	Time signatures	1/4 to 16/4, 1/8 to 16/8, and 1/16 to 16/16	
	Subdivisions	Accents, quarter notes, eighth notes, sixteenth notes, and eight-note triplets	
	Others	Individual click volume control, wav import, timer	
Training	Types	10	
	Training Songs	Preset: 37 songs User: 1 song	
Audio files	Import limit	1,000 files	
	Maximum loadable sample time	50 minutes 40 seconds (44.1 kHz, 16 bit, mono) 25 minutes 20 seconds (44.1 kHz, 16 bit, stereo)	
	Sampling format	WAV	
Recorder	Recording time	Internal memory	maximum of 90 seconds
		USB flash drive	maximum of 90 minutes per file
	Format	Record/playback	WAV (44.1 kHz, 16 bit, stereo)
Display			Full Dot LCD (128×64 dot)
Connectivity	DC IN		DC IN (+12V)
	Headphones		Headphones (standard stereo phone jack ×1, stereo mini jack ×1)
	AUX IN		AUX IN (stereo mini jack ×1, stereo standard phone jack ×1)
	Output		OUTPUT L/MONO, R (standard phone jack, one for each) INDIVIDUAL OUTPUT 1/2, 3/4, 5/6, 7/8 (stereo standard phone jack, one for each)
	USB		USB TO DEVICE USB TO HOST
	MIDI		MIDI OUT ×1 MIDI IN ×1
	Trigger Input	Jacks	10 (standard stereo phone jack, not including the HI-HAT CONTROL jack)
		Maximum number of pads to be connected (when Y-cable is used)	14
<b>Bluetooth</b> (May not have this functionality depending on the country in which you purchased the product.)	Supported profile		A2DP
	Compatible codec		SBC
	Bluetooth version		4.1
	Wireless output		Bluetooth class 2
	Maximum communication distance		Approx. 10 m
	Radio Frequency (Operational Frequency)		2402–2480 MHz
	Maximum output power (EIRP)		+4 dBm
	Type of modulation		GFSK, π/4 DQPSK, 8DPSK
Power consumption			13 W
Dimensions			342 (W) mm × 196 (D) mm × 66 (H) mm (13-7/16 in × 7-11/16 in × 2-5/8 in)
Weight			2.0 kg (4 lb 7 oz)
Included Accessories			AC adaptor (PA-150 or an equivalent recommended by Yamaha (Output : DC 12V, 1.5 A))(*2), Owner's Manual (this document), module holder, module holder wing bolts (× 4), Cubase AI Download Information  (*2) May not be included depending on your area. Check with your Yamaha dealer.

The contents of this manual apply to the latest specifications as of the publishing date. To obtain the latest manual, access the Yamaha website then download the manual file. Since specifications, equipment or separately sold accessories may not be the same in every locale, please check with your Yamaha dealer.



# Index

## Symbols

[–][+] controllers.....	11
[–][+] knob .....	11
[–] button .....	11
[+] button .....	11

## Numerics

1-zone pads.....	27
3-zone pads .....	27

## A

AC adaptor .....	15
Accompaniment .....	48
Acoustic Drums .....	53
Ambience .....	26
[AMBIENCE] knob .....	10, 33
Audio files (.wav) .....	37
[AUDIO] slider .....	11
[AUDITION] button .....	11
Auto Power-Off .....	19
[AUX IN] (auxiliary input) jack ...	12, 13
[AUX IN] slider.....	11

## B

Bell shots .....	30
Bluetooth.....	4, 11, 24
Bow shots.....	29, 30

## C

Choking.....	30
Click .....	42, 43
[CLICK] button.....	11
CLICK mode .....	10
[CLICK] slider.....	11
Click Tempo Display .....	11
Closed rim shots .....	28
Comp.....	26
[COMP] knob .....	10, 33
Computer .....	54
Cord hook.....	13
Cross stick setting .....	10
Cross sticking.....	28
CUSTM (Custom).....	10
Custom settings.....	34
Cymbal Size .....	34
Cymbals .....	30

## D

DAW (Digital Audio Workstation) software .....	54
DC IN jack.....	13
Display .....	10
Drum set .....	26, 34

## E

Edge shots .....	29, 30
Effect .....	26, 33, 34
[EFFECT] knob .....	10, 33
EFFECT screen .....	10
[EXIT] button .....	11

## F

Factory Reset.....	20
Fader Select knob .....	10
Foot-close sounds.....	29
Front Panel.....	12
Function Buttons 1–3 ([F1], [F2], [F3]).....	10
FX (Effects) .....	10

## H

Head shots .....	28
Headphones.....	16
Hi-hat clutch positions.....	34
Hi-hat splash sounds .....	29
Hi-hats.....	29

## I

[INDIVIDUAL OUTPUT] jacks ...	13, 49
INST .....	10
Inst .....	26, 34

## K

Kit.....	26, 32
KIT mode .....	10
KIT MODIFIER knobs .....	10
KIT screen.....	10, 32

## L

LED Rotary Faders .....	10
LIVE SET mode .....	10
Live Sets .....	50

## M

[MENU] button.....	11
Metronome .....	42, 43
[MIDI IN] connector .....	13
[MIDI OUT] connector .....	13
MIXER.....	10
Mixer .....	34, 35
Mode Select knob .....	10
Monaural pads .....	27
MUFFL (Muffling) .....	10
Muffling.....	34
Multi Piezo .....	27
Multi-piezo pads.....	51
Muting .....	31, 34

## O

Open rim shots .....	28
Open/Close .....	29
OUTPUT [R]/[L/MONO] jacks .....	13
[OUTPUT] slider.....	11

## P

PA.....	49
[PAD SELECT] button .....	11
Pads.....	27
Paring.....	24
[PHONES] (Headphone) jack .....	12
[PHONES] slider .....	11
Position sensing .....	27, 28, 30

## R

Rear Panel .....	13
RECORDER mode .....	10

## S

Separately Sold Accessories.....	52
Single Piezo .....	27
Single-piezo pads .....	51
Smart Devices.....	23
Snare .....	28
[⏻] (Standby/On) switch.....	11
Step.....	50
[STORE] button .....	11
Sustain length of the cymbal.....	34

## T

Tap Tempo.....	43
Tempo .....	42
[TEMPO] knob .....	11
Tom .....	28
Top Panel .....	10
Trigger Input jacks.....	13, 51
TRIGGER mode.....	10
Trigger Settings .....	45
Trigger Setup Wizard.....	17
TUNING .....	10
Tunings.....	34

## U

[USB TO DEVICE] terminal.....	13, 21
[USB TO HOST] terminal .....	13, 54

## W

.wav.....	37
-----------	----

## Y

Y-cable .....	51
---------------	----

## Z

Zones.....	27
------------	----

# Drums Limited Warranty

## LIMITED WARRANTY ON YAMAHA DRUMS, HARDWARE AND ACCESSORY PRODUCTS

Thank you for selecting a YAMAHA product. YAMAHA products are designed and manufactured to provide a high level of defect-free performance. Yamaha Corporation of America ("YAMAHA") is proud of the experience and craftsmanship that goes into each and every YAMAHA product. YAMAHA sells its products through a network of reputable, specially authorized dealers and is pleased to offer you, the Original Owner, the following Limited Warranty, which applies only to products that have been (1) directly purchased from YAMAHA's authorized dealers in the fifty states of the USA and District of Columbia (the "Warranted Area") and (2) used exclusively in the Warranted Area. YAMAHA suggests that you read the Limited Warranty thoroughly, and invites you to contact your authorized YAMAHA dealer or YAMAHA Customer Service if you have any questions.

### THIS WARRANTY COVERS THE LISTED PRODUCTS AGAINST DEFECTS IN MATERIALS OR WORKMANSHIP.

Warranty Term

*Duration of Warranty from Date of  
Purchase by or for the Original Owner*

*Type of Product*

<b>Acoustic Drum Shells, Finish, Drum Hardware, Freestanding Hardware, Pedals, Hardware Accessories</b>	<b>5 Years</b>
<b>Electronic Drums Modules, Pads, Accessories, Hardware, Pedals</b>	<b>1 Year</b>

**Coverage:** YAMAHA will, at its option, repair or replace the product covered by this warranty if it becomes defective, malfunctions or otherwise fails to conform with this warranty under normal use and service during the term of this warranty, without charge for labor or materials. Repairs may be performed using new or refurbished parts that meet or exceed YAMAHA specifications for new parts. If YAMAHA elects to replace the product, the replacement may be a reconditioned unit. You will be responsible for any installation or removal charges and for any initial shipping charges if the product(s) must be shipped for warranty service. However, YAMAHA will pay the return shipping charges to any destination within the USA if the repairs are covered by the warranty. This warranty does not cover (a) damage, deterioration or malfunction resulting from accident, negligence, misuse, abuse, improper installation or operation or failure to follow instructions according to the Owner's Manual for this product; any shipment of the product (claims must be presented to the carrier); repair or attempted repair by anyone other than YAMAHA or an authorized YAMAHA Service Center; (b) any unit which has been altered or on which the serial number has been defaced, modified or removed; (c) normal wear and any periodic maintenance; (d) deterioration due to perspiration, corrosive atmosphere or other external causes such as extremes in temperature or humidity; (e) damages attributable to power line surge or related electrical abnormalities, lightning damage or acts of God; or (f) RFI/EMI (Interference/noise) caused by improper grounding or the improper use of either certified or uncertified equipment, if applicable. Any evidence of alteration, erasing or forgery of proof-of-purchase documents will cause this warranty to be void. This warranty covers only the Original Owner and is not transferable.

**In Order to Obtain Warranty Service:** Warranty service will only be provided for defective products within the Warranted Area. Contact your local authorized YAMAHA dealer who will advise you of the procedures to be followed. If this is not successful, contact YAMAHA at the address, telephone number or website shown below. YAMAHA may request that you send the defective product to a local authorized YAMAHA Servicer or authorize return of the defective product to YAMAHA for repair. If you are uncertain as to whether a dealer has been authorized by YAMAHA, please contact YAMAHA's Service Department at the number shown below, or check Yamaha's website at <http://usa.yamaha.com>. Product(s) shipped for service should be packed securely and must be accompanied by a detailed explanation of the problem(s) requiring service, together with the original or a machine reproduction of the bill of sale or other dated, proof-of-purchase document describing the product, as evidence of warranty coverage. Should any product submitted for warranty service be found ineligible therefore, an estimate of repair cost will be furnished and the repair will be accomplished only if requested by you and upon receipt of payment or acceptable arrangement for payment.

**Limitation of Implied Warranties and Exclusion of Damages:** ANY IMPLIED WARRANTIES, INCLUDING WARRANTIES OF MERCHANTABILITY AND FITNESS FOR A PARTICULAR PURPOSE SHALL BE LIMITED IN DURATION TO THE APPLICABLE PERIOD OF TIME SET FORTH ABOVE. YAMAHA SHALL NOT BE RESPONSIBLE FOR INCIDENTAL OR CONSEQUENTIAL DAMAGES OR FOR DAMAGES BASED UPON INCONVENIENCE, LOSS OF USE, DAMAGE TO ANY OTHER EQUIPMENT OR OTHER ITEMS AT THE SITE OF USE OR INTERRUPTION OF PERFORMANCES OR ANY CONSEQUENCES. YAMAHA'S LIABILITY FOR ANY DEFECTIVE PRODUCT IS LIMITED TO REPAIR OR REPLACEMENT OF THE PRODUCT, AT YAMAHA'S OPTION. SOME STATES DO NOT ALLOW LIMITATIONS ON HOW LONG AN IMPLIED WARRANTY LASTS OR THE EXCLUSION OR LIMITATION OF INCIDENTAL OR CONSEQUENTIAL DAMAGES, SO THE ABOVE LIMITATION OR EXCLUSION MAY NOT APPLY TO YOU. This Warranty gives you specific legal rights, and you may also have other rights which vary from state to state. This is the only express warranty applicable to the product specified herein; Yamaha neither assumes nor authorizes anyone to assume for it any other express warranty.

If you have any questions about service received or if you need assistance in locating an authorized YAMAHA Servicer, please contact:



CUSTOMER SERVICE

Yamaha Corporation of America

6600 Orangethorpe Avenue, Buena Park, California 90620-1373

Telephone: 800-854-1569 • <http://usa.yamaha.com>

**Do not return any product to the above address without a written Return Authorization issued by YAMAHA.**

# Important Notice: Guarantee Information for customers in European Economic Area (EEA) and Switzerland

<p><b>Important Notice: Guarantee Information for customers in EEA* and Switzerland</b></p> <p>For detailed guarantee information about this Yamaha product, and Pan-EEA* and Switzerland warranty service, please either visit the website address below (Printable file is available at our website) or contact the Yamaha representative office for your country. * EEA: European Economic Area</p>	English
<p><b>Wichtiger Hinweis: Garantie-Information für Kunden in der EWR* und der Schweiz</b></p> <p>Für nähere Garantie-Information über dieses Produkt von Yamaha, sowie über den Pan-EWR*- und Schweizer Garantieservice, besuchen Sie bitte entweder die folgend angegebene Internetadresse (eine druckfähige Version befindet sich auch auf unserer Webseite), oder wenden Sie sich an den für Ihr Land zuständigen Yamaha-Vertrieb. *EWR: Europäischer Wirtschaftsraum</p>	Deutsch
<p><b>Remarque importante: informations de garantie pour les clients de l'EEE et la Suisse</b></p> <p>Pour des informations plus détaillées sur la garantie de ce produit Yamaha et sur le service de garantie applicable dans l'ensemble de l'EEE ainsi qu'en Suisse, consultez notre site Web à l'adresse ci-dessous (le fichier imprimable est disponible sur notre site Web) ou contactez directement Yamaha dans votre pays de résidence. * EEE : Espace Economique Européen</p>	Français
<p><b>Belangrijke mededeling: Garantie-informatie voor klanten in de EER* en Zwitserland</b></p> <p>Voor gedetailleerde garantie-informatie over dit Yamaha-product en de garantieservice in heel de EER* en Zwitserland, gaat u naar de onderstaande website (u vindt een afdrukbaar bestand op onze website) of neemt u contact op met de vertegenwoordiging van Yamaha in uw land. * EER: Europese Economische Ruimte</p>	Nederlands
<p><b>Aviso importante: información sobre la garantía para los clientes del EEE* y Suiza</b></p> <p>Para una información detallada sobre este producto Yamaha y sobre el soporte de garantía en la zona EEE* y Suiza, visite la dirección web que se incluye más abajo (la versión del archivo para imprimir esta disponible en nuestro sitio web) o póngase en contacto con el representante de Yamaha en su país. * EEE: Espacio Económico Europeo</p>	Español
<p><b>Avviso importante: informazioni sulla garanzia per i clienti residenti nell'EEA* e in Svizzera</b></p> <p>Per informazioni dettagliate sulla garanzia relativa a questo prodotto Yamaha e l'assistenza in garanzia nei paesi EEA* e in Svizzera, potete consultare il sito Web all'indirizzo riportato di seguito (è disponibile il file in formato stampabile) oppure contattare l'ufficio di rappresentanza locale della Yamaha. * EEA: Area Economica Europea</p>	Italiano
<p><b>Aviso importante: informações sobre as garantias para clientes da AEE* e da Suíça</b></p> <p>Para obter uma informação pormenorizada sobre este produto da Yamaha e sobre o serviço de garantia na AEE* e na Suíça, visite o site a seguir (o arquivo para impressão está disponível no nosso site) ou entre em contato com o escritório de representação da Yamaha no seu país. * AEE: Área Econômica Européia</p>	Português
<p><b>Σημαντική σημείωση: Πληροφορίες εγγύησης για τους πελάτες στον ΕΟΧ* και Ελλάδα</b></p> <p>Για λεπτομερείς πληροφορίες εγγύησης σχετικά με το παρόν προϊόν της Yamaha και την κάλυψη εγγύησης σε όλες τις χώρες του ΕΟΧ και την Ελλάδα, επισκεφτείτε την παρακάτω ιστοσελίδα (Εκτυπώσιμη μορφή είναι διαθέσιμη στην ιστοσελίδα μας) ή απευθυνθείτε στην αντιπροσωπεία της Yamaha στη χώρα σας. * ΕΟΧ: Ευρωπαϊκός Οικονομικός Χώρος</p>	Ελληνικά
<p><b>Viktigt: Garantiinformation för kunder i EES-området* och Schweiz</b></p> <p>För detaljerad information om denna Yamahaprodukt samt garantiservice i hela EES-området* och Schweiz kan du antingen besöka nedanstående webbadress (en utskriftsvänlig fil finns på webbplatsen) eller kontakta Yamahas officiella representant i ditt land. * EES: Europeiska Ekonomiska Samarbetsområdet</p>	Svenska
<p><b>Viktig merknad: Garantiinformasjon for kunder i EØS* og Sveits</b></p> <p>Detaljert garantiinformasjon om dette Yamaha-produktet og garantiservice for hele EØS-området* og Sveits kan fås enten ved å besøke nettstedene nedenfor (utskriftsversjon finnes på våre nettsider) eller kontakte Yamahas kontoret i landet der du bor. *EØS: Det europeiske økonomiske samarbeidsområdet</p>	Norsk
<p><b>Vigtig oplysning: Garantioplysninger til kunder i EØO* og Schweiz</b></p> <p>De kan finde detaljerede garantioplysninger om dette Yamaha-produkt og den fælles garantiserviceordning for EØO* (og Schweiz) ved at besøge det websted, der er angivet nedenfor (der findes en fil, som kan udskrives, på vores websted), eller ved at kontakte Yamahas nationale repræsentationskontor i det land, hvor De bor. * EØO: Det Europæiske Økonomiske Område</p>	Dansk
<p><b>Tärkeä ilmoitus: Takuutiedot Euroopan talousalueen (ETA)* ja Sveitsin asiakkaille</b></p> <p>Tämän Yamaha-tuotteen sekä ETA-alueen ja Sveitsin takuuta koskevat yksityiskohtaiset tiedot saatte alla olevasta nettiosoitteesta. (Tulostettava tiedosto saatavissa sivustollamme.) Voitte myös ottaa yhteyttä paikalliseen Yamaha-edustajaan. *ETA: Euroopan talousalue</p>	Suomi
<p><b>Ważne: Warunki gwarancyjne obowiązujące w EOG* i Szwajcarii</b></p> <p>Aby dowiedzieć się więcej na temat warunków gwarancyjnych tego produktu firmy Yamaha i serwisu gwarancyjnego w całym EOG* i Szwajcarii, należy odwiedzić wskazaną poniżej stronę internetową (Plik gotowy do wydruku znajduje się na naszej stronie internetowej) lub skontaktować się z przedstawicielstwem firmy Yamaha w swoim kraju. * EOG — Europejski Obszar Gospodarczy</p>	Polski
<p><b>Důležité oznámení: Záruční informace pro zákazníky v EHS* a ve Švýcarsku</b></p> <p>Podrobné záruční informace o tomto produktu Yamaha a záručním servisu v celém EHS* a ve Švýcarsku naleznete na níže uvedené webové adrese (soubor k tisku je dostupný na našich webových stránkách) nebo se můžete obrátit na zastoupení firmy Yamaha ve své zemi. * EHS: Evropský hospodářský prostor</p>	Česky
<p><b>Fontos figyelemzetés: Garancia-információk az EGT* területén és Svájcban élő vásárlók számára</b></p> <p>A jelen Yamaha termékre vonatkozó részletes garancia-információk, valamint az EGT*-re és Svájcra kiterjedő garanciális szolgáltatás tekintetében keresse fel webhelyünket az alábbi címen (a webhelyen nyomtatható fájl is található), vagy pedig lépjen kapcsolatba az országában működő Yamaha képviselői irodával. * EGT: Európai Gazdasági Térség</p>	Magyar
<p><b>Oluline märkus: Garantiiteave Euroopa Majanduspiirkonna (EMP)* ja Šveitsi klientidele</b></p> <p>Täpsemat teabe saamiseks selle Yamaha toote garantii ning kogu Euroopa Majanduspiirkonna ja Šveitsi garantiiteeninduse kohta, külastage palun veebisaiti alljärgneval aadressil (meie saidil on saadaval printitav fail) või pöörduge Teie regiooni Yamaha esinduse poole. * EMP: Euroopa Majanduspiirkond</p>	Eesti keel
<p><b>Svarīgs paziņojums: garantijas informācija klientiem EEZ* un Šveicē</b></p> <p>Lai saņemtu detalizētu garantijas informāciju par šo Yamaha produktu, kā arī garantijas apkalpošanu EEZ* un Šveicē, lūdz, apmeklējiet zemāk norādīto tīmekļa vietnes adresi (tīmekļa vietnē ir pieejams drukājams fails) vai sazinieties ar jūsu valsti apkalpojošo Yamaha pārstāvniecību. * EEZ: Eiropas Ekonomikas zona</p>	Latviešu
<p><b>Děmesio: informacija dėl garantijos pirkėjams EEE* ir Šveicarijoje</b></p> <p>Jei reikia išsamios informacijos apie šį „Yamaha“ produktą ir jo techninę priežiūrą visoje EEE* ir Šveicarijoje, apsilankykite mūsų svetainėje toliau nurodytu adresu (svetainėje yra spausdinamas failas) arba kreipkitės į „Yamaha“ atstovybę savo šaliai. *EEE – Europos ekonominė erdvė</p>	Lietuvių kalba
<p><b>Dôležité upozornenie: Informácie o záruke pre zákazníkov v EHP* a Švajčiarsku</b></p> <p>Podrobné informácie o záruke týkajúce sa tohto produktu od spoločnosti Yamaha a garančnom servise v EHP* a Švajčiarsku nájdete na webovej stránke uvedenej nižšie (na našej webovej stránke je k dispozícii súbor na tlač) alebo sa obráťte na zástupcu spoločnosti Yamaha vo svojej krajine. * EHP: Európsky hospodársky priestor</p>	Slovenčina
<p><b>Pomembno obvestilo: Informacije o garanciji za kupce v EGP* in Švici</b></p> <p>Za podrobnejše informacije o tem Yamahinim izdelku ter garancijskem servisu v celotnem EGP in Švici, obiščite spletno mesto, ki je navedeno spodaj (natisljiva datoteka je na voljo na našem spletnem mestu), ali se obrnite na Yamahinega predstavnika v svoji državi. * EGP: Evropski gospodarski prostor</p>	Slovenščina
<p><b>Важно съобщение: Информация за гаранцията за клиенти в ЕИП* и Швейцария</b></p> <p>За подробна информация за гаранцията за този продукт на Yamaha и гаранционното обслужване в паневропейската зона на ЕИП* и Швейцария или посетете посочения по-долу уеб сайт (на нашия уеб сайт има файл за печат), или се свържете с представителния офис на Yamaha във вашата страна. * ЕИП: Европейско икономическо пространство</p>	Български език
<p><b>Notificare importantă: Informații despre garanție pentru clienții din SEE* și Elveția</b></p> <p>Pentru informații detaliate privind acest produs Yamaha și serviciul de garanție Pan-SEE* și Elveția, vizitați site-ul la adresa de mai jos (fișierul imprimabil este disponibil pe site-ul nostru) sau contactați biroul reprezentanței Yamaha din țara dumneavoastră. * SEE: Spațiul Economic European</p>	Limba română
<p><b>Važna obavijest: Informacije o jamstvu za države EGP-a i Švicarske</b></p> <p>Za detaljne informacije o jamstvu za ovaj Yamahin proizvod te jamstvenom servisu za cijeli EGP i Švicarsku, molimo Vas da posjetite web-stranicu navedenu u nastavku ili kontaktirate ovlaštenog Yamahinog dobavljača u svojoj zemlji. * EGP: Evropski gospodarski prostor</p>	Hrvatski

<https://europe.yamaha.com/warranty/>

URL\_5

For details of products, please contact your nearest Yamaha representative or the authorized distributor listed below.

Pour plus de détails sur les produits, veuillez-vous adresser à Yamaha ou au distributeur le plus proche de vous figurant dans la liste suivante.

Die Einzelheiten zu Produkten sind bei Ihrer unten aufgeführten Niederlassung und bei Yamaha Vertragshändlern in den jeweiligen Bestimmungsländern erhältlich.

Para detalles sobre productos, contacte su tienda Yamaha más cercana o el distribuidor autorizado que se lista debajo.

## NORTH AMERICA

### CANADA

**Yamaha Canada Music Ltd.**  
135 Milner Avenue, Toronto, Ontario M1S 3R1, Canada  
Tel: +1-416-298-1311

### U.S.A.

**Yamaha Corporation of America**  
6600 Orangethorpe Avenue, Buena Park, CA 90620, U.S.A.  
Tel: +1-714-522-9011

## CENTRAL & SOUTH AMERICA

### MEXICO

**Yamaha de México, S.A. de C.V.**  
Av. Insurgentes Sur 1647 Piso 9, Col. San José Insurgentes,  
Delegación Benito Juárez, CDMX,  
C.P. 03900, México  
Tel: +52-55-5804-0600

### BRAZIL

**Yamaha Musical do Brasil Ltda.**  
Praça Professor José Lannes, 40-Cjs 21 e 22, Brooklin  
Paulista Novo CEP 04571-100 – São Paulo – SP, Brazil  
Tel: +55-11-3704-1377

### ARGENTINA

**Yamaha Music Latin America, S.A.,  
Sucursal Argentina**  
Olga Cossetini 1553, Piso 4 Norte,  
Madero Este-C1107CEK,  
Buenos Aires, Argentina  
Tel: +54-11-4119-7000

### PANAMA AND OTHER LATIN

### AMERICAN REGIONS/ CARIBBEAN REGIONS

**Yamaha Music Latin America, S.A.**  
Edificio Torre Davivienda, Piso: 20  
Avenida Balboa, Marbella, Corregimiento de Bella Vista,  
Ciudad de Panamá, Rep. de Panamá  
Tel: +507-269-5311

## EUROPE

### THE UNITED KINGDOM/IRELAND

**Yamaha Music Europe GmbH (UK)**  
Sherbourne Drive, Tilbrook, Milton Keynes,  
MK7 8BL, U.K.  
Tel: +44-1908-366700

### GERMANY

**Yamaha Music Europe GmbH**  
Siemensstrasse 22-34, 25462 Rellingen, Germany  
Tel: +49-4101-303-0

### SWITZERLAND/LIECHTENSTEIN

**Yamaha Music Europe GmbH, Branch  
Switzerland in Thalwil**  
Seestrasse 18a, 8800 Thalwil, Switzerland  
Tel: +41-44-3878080

### AUSTRIA/CROATIA/CZECH REPUBLIC/ HUNGARY/ROMANIA/SLOVAKIA/SLOVENIA

**Yamaha Music Europe GmbH, Branch Austria**  
Schleiergasse 20, 1100 Wien, Austria  
Tel: +43-1-60203900

### POLAND

**Yamaha Music Europe  
Sp.z o.o. Oddzial w Polsce**  
ul. Wielicka 52, 02-657 Warszawa, Poland  
Tel: +48-22-880-08-88

### BULGARIA

**Dinacord Bulgaria LTD.**  
Bul. Iskarsko Schose 7 Targowski Zentar Ewropa  
1528 Sofia, Bulgaria  
Tel: +359-2-978-20-25

### MALTA

**Olimpus Music Ltd.**  
Valletta Road, Mosta MST9010, Malta  
Tel: +356-2133-2093

### NETHERLANDS/BELGIUM/ LUXEMBOURG

**Yamaha Music Europe, Branch Benelux**  
Clarissenhof 5b, 4133 AB Vianen, The Netherlands  
Tel: +31-347-358040

### FRANCE

**Yamaha Music Europe**  
7 rue Ambroise Croizat, Zone d'activités de Pariest,  
77183 Croissy-Beaubourg, France  
Tel: +33-1-6461-4000

### ITALY

**Yamaha Music Europe GmbH, Branch Italy**  
Via Tinelli N.67/69 20855 Gerno di Lesmo (MB), Italy  
Tel: +39-039-9065-1

### SPAIN/PORTUGAL

**Yamaha Music Europe GmbH Ibérica, Sucursal en  
España**  
Ctra. de la Coruña km. 17,200, 28231  
Las Rozas de Madrid, Spain  
Tel: +34-91-639-88-88

### GREECE

**Philippos Nakas S.A. The Music House**  
19th km. Leof. Lavriou 190 02 Peania – Attiki, Greece  
Tel: +30-210-6686260

### SWEDEN

**Yamaha Music Europe GmbH Germany Filial  
Scandinavia**  
JA Wettergrensgata 1, 400 43 Göteborg, Sweden  
Tel: +46-31-89-34-00

### DENMARK

**Yamaha Music Denmark,  
Filial of Yamaha Music Europe GmbH, Tyskland**  
Generatorvej 8C, ST. TH., 2860 Søborg, Denmark  
Tel: +45-44-92-49-00

### FINLAND

**F-Musiikki Oy**  
Antaksentie 4  
FI-01510 Vantaa, Finland  
Tel: +358 (0)96185111

### NORWAY

**Yamaha Music Europe GmbH Germany -  
Norwegian Branch**  
Grini Næringspark 1, 1332 Østerås, Norway  
Tel: +47-6716-7800

### ICELAND

**Hljóðfaerahúsid Ehf.**  
Sidumula 20  
IS-108 Reykjavik, Iceland  
Tel: +354-525-5050

### CYPRUS

**Nakas Music Cyprus Ltd.**  
Nikis Ave 2k  
1086 Nicosia  
Tel: +357-22-511080  
**Major Music Center**  
21 Ali Riza Ave. Ortakoy  
P.O.Box 475 Lefkosia, Cyprus  
Tel: (392) 227 9213

### RUSSIA

**Yamaha Music (Russia) LLC.**  
Room 37, entrance 7, bld. 7, Kievskaya street, Moscow,  
121059, Russia  
Tel: +7-495-626-5005

### OTHER EUROPEAN REGIONS

**Yamaha Music Europe GmbH**  
Siemensstrasse 22-34, 25462 Rellingen, Germany  
Tel: +49-4101-303-0

## AFRICA

**Yamaha Music Gulf FZE**  
JAFZA-16, Office 512, P.O.Box 17328,  
Jebel Ali FZE, Dubai, UAE  
Tel: +971-4-801-1500

## MIDDLE EAST

### TURKEY

**Yamaha Music Europe GmbH  
Merkezi Almanya Türkiye İstanbul Şubesi**  
Mor Sumbul Sokak Varyap Meridian Business 1.Blok No:1  
113-114-115  
Bati Atasehir Istanbul, Turkey  
Tel: +90-216-275-7960

### ISRAEL

**RBX International Co., Ltd.**  
P.O Box 10245, Petach-Tikva, 49002  
Tel: (972) 3-925-6900

## OTHER REGIONS

**Yamaha Music Gulf FZE**  
JAFZA-16, Office 512, P.O.Box 17328,  
Jebel Ali FZE, Dubai, UAE  
Tel: +971-4-801-1500

## ASIA

### THE PEOPLE'S REPUBLIC OF CHINA

**Yamaha Music & Electronics (China) Co., Ltd.**  
2F, Yunhedasha, 1818 Xinzha-lu, Jingan-qu,  
Shanghai, China  
Tel: +86-400-051-7700

### HONG KONG

**Tom Lee Music Co., Ltd.**  
11/F, Silvercord Tower 1, 30 Canton Road,  
Tsimshatsui, Kowloon, Hong Kong  
Tel: +852-2737-7688

### INDIA

**Yamaha Music India Private Limited**  
P-401, JMD Megapolis, Sector-48, Sohna Road,  
Gurugram-122018, Haryana, India  
Tel: +91-124-485-3300

### INDONESIA

**PT Yamaha Musik Indonesia Distributor**  
Yamaha Music Center Bldg. Jalan Jend. Gatot Subroto Kav.  
4, Jakarta 12930, Indonesia  
Tel: +62-21-520-2577

### KOREA

**Yamaha Music Korea Ltd.**  
11F, Prudential Tower, 298, Gangnam-daero, Gangnam-gu,  
Seoul, 06253, Korea  
Tel: +82-2-3467-3300

### MALAYSIA

**Yamaha Music (Malaysia) Sdn. Bhd.**  
No.8, Jalan Perbandaran, Kelana Jaya, 47301  
Petaling Jaya, Selangor, Malaysia  
Tel: +60-3-78030900

### SINGAPORE

**Yamaha Music (Asia) Private Limited**  
Block 202 Hougang Street 21, #02-00,  
Singapore 530202, Singapore  
Tel: +65-6740-9200

### TAIWAN

**Yamaha Music & Electronics Taiwan Co., Ltd.**  
2F., No.1, Yuandong Rd., Banqiao Dist.,  
New Taipei City 22063, Taiwan (R.O.C.)  
Tel: +886-2-7741-8888

### THAILAND

**Siam Music Yamaha Co., Ltd.**  
3, 4, 15, 16th Fl., Siam Motors Building,  
891/1 Rama 1 Road, Wangmai,  
Pathumwan, Bangkok 10350, Thailand  
Tel: +66-2215-2622

### VIETNAM

**Yamaha Music Vietnam Company Limited**  
15th Floor, Nam A Bank Tower, 201-203 Cach Mang Thang  
Tam St., Ward 4, Dist.3,  
Ho Chi Minh City, Vietnam  
Tel: +84-28-3818-1122

### OTHER ASIAN REGIONS

<https://asia-latinamerica-mea.yamaha.com/index.html>

## OCEANIA

### AUSTRALIA

**Yamaha Music Australia Pty. Ltd.**  
Level 1, 80 Market Street, South Melbourne,  
VIC 3205 Australia  
Tel: +61-3-9693-5111

### NEW ZEALAND

**Music Works LTD**  
P.O.BOX 6246 Wellesley, Auckland 4680,  
New Zealand  
Tel: +64-9-634-0099

### REGIONS AND TRUST

### TERRITORIES IN PACIFIC OCEAN

<https://asia-latinamerica-mea.yamaha.com/index.html>

**Head Office/Manufacturer: Yamaha Corporation** 10-1, Nakazawa-cho, Naka-ku, Hamamatsu, 430-8650, Japan

**Importer (European Union): Yamaha Music Europe GmbH** Siemensstrasse 22-34, 25462 Rellingen, Germany

**Importer (United Kingdom): Yamaha Music Europe GmbH (UK)** Sherbourne Drive, Tilbrook, Milton Keynes, MK7 8BL, United Kingdom

DMI30