

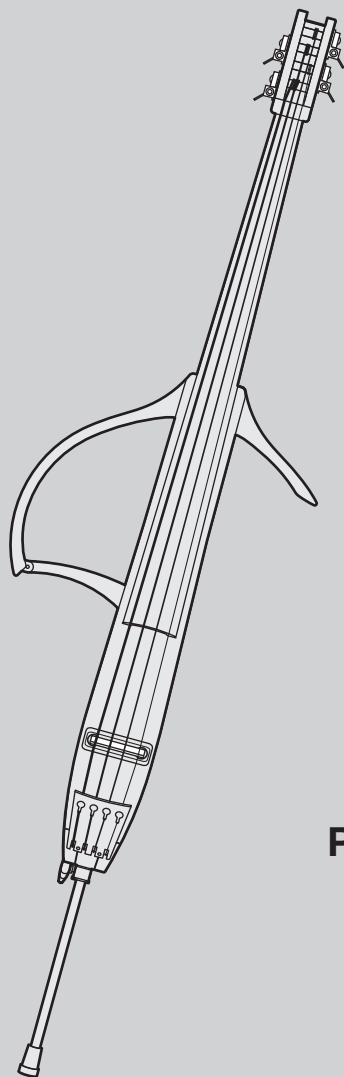

# SILENT *Bass*<sup>TM</sup>



**SLB300 PRO**  
**SLB300**

**取扱説明書**  
**Owner's Manual**  
**Benutzerhandbuch**  
**Mode d'emploi**  
**Manuale di istruzioni**  
**Manual de instrucciones**  
**Manual do Proprietário**  
**Руководство пользователя**  
**사용설명서**  
**使用说明书**

**JA EN DE FR IT ES PT RU KO ZH**

日本語

English

Deutsch

Français

Italiano

Español

Português

Русский

한국어

中文

# SILENT *Bass*<sup>TM</sup>

## **SLB300 Series**

### **Owner's Manual**

Thank you very much for purchasing the Yamaha "SILENT Bass<sup>TM</sup>!"

The SLB300 series are a brand-new type of electric upright bass that achieves natural sound and resonance by using the SRT POWERED system to reproduce studio-quality sound in which the body resonance of a double bass was recorded using a high-quality microphone, all the while keeping a semi-solid body structure that emphasizes quietness and portability. The SLB300 PRO is a high-end model that not only pursues a high-quality appearance, but also maximizes the natural sound and playability with carefully selected parts.

In order to obtain the maximum performance and enjoyment from this product, we urge you to read this Owner's Manual thoroughly before using the instrument. Please keep this Owner's Manual, together with the warranty, in a safe place for later reference.

## **Contents**

|   |           |
|---|-----------|
| <b>Included Accessories</b> .....                           | <b>7</b>  |
| <b>Parts and their Names</b> .....                          | <b>8</b>  |
| Front .....   | 8         |
| Rear .....  | 8         |
| Battery Case/External Output (LINE OUT) Jack .....          | 9         |
| Controls .....  | 9         |
| <b>Setup</b> .....  | <b>12</b> |
| Tuning .....  | 12        |
| Attaching the Frame Unit .....                              | 14        |
| About the End Pin .....                                     | 15        |
| Attaching the Optional Accessories .....                    | 15        |
| Preparing the Power Supply (How to Replace Batteries) ..... | 16        |
| Connection Example .....                                    | 17        |
| Turning the Power On and Off .....                          | 18        |
| About the Mute .....  | 18        |
| <b>Changing Strings</b> .....                               | <b>19</b> |
| <b>Putting the Bass into the Soft Case</b> .....            | <b>21</b> |
| <b>Specifications</b> .....                                 | <b>22</b> |

# FCC INFORMATION (U.S.A.)

## 1. **IMPORTANT NOTICE: DO NOT MODIFY THIS UNIT!**

This product, when installed as indicated in the instructions contained in this manual, meets FCC requirements. Modifications not expressly approved by Yamaha may void your authority, granted by the FCC, to use the product.

**2. IMPORTANT:** When connecting this product to accessories and/or another product use only high quality shielded cables. Cable/s supplied with this product **MUST** be used. Follow all installation instructions. Failure to follow instructions could void your FCC authorization to use this product in the USA.

**3. NOTE:** This product has been tested and found to comply with the requirements listed in FCC Regulations, Part 15 for Class "B" digital devices. Compliance with these requirements provides a reasonable level of assurance that your use of this product in a residential environment will not result in harmful interference with other electronic devices. This equipment generates/uses radio frequencies and, if not installed and used according to the instructions found in the users manual, may cause interference harmful to the operation of other electronic devices. Compliance with FCC

regulations does not guarantee that interference will not occur in all installations. If this product is found to be the source of interference, which can be determined by turning the unit "OFF" and "ON," please try to eliminate the problem by using one of the following measures:

Relocate either this product or the device that is being affected by the interference.

Utilize power outlets that are on different branch (circuit breaker or fuse) circuits or install AC line filter/s.

In the case of radio or TV interference, relocate/reorient the antenna. If the antenna lead-in is 300 ohm ribbon lead, change the lead-in to co-axial type cable.

If these corrective measures do not produce satisfactory results, please contact the local retailer authorized to distribute this type of product. If you can not locate the appropriate retailer, please contact Yamaha Corporation of America, Electronic Service Division, 6600 Orangethorpe Ave, Buena Park, CA90620

The above statements apply **ONLY** to those products distributed by Yamaha Corporation of America or its subsidiaries.

\* This applies only to products distributed by Yamaha Corporation of America.

(class B)

**COMPLIANCE INFORMATION STATEMENT**  
**(Supplier's declaration of conformity procedure)**

Responsible Party : Yamaha Corporation of America  
Address : 6600 Orangethorpe Ave., Buena Park, Calif. 90620  
Telephone : 714-522-9011  
Type of Equipment : Electric Upright Bass  
Model Name : SLB300

This device complies with Part 15 of the FCC Rules.

Operation is subject to the following two conditions:

- 1) this device may not cause harmful interference, and
- 2) this device must accept any interference received including interference that may cause undesired operation.

\* This applies only to products distributed by Yamaha Corporation of America. (FCC SDoC)

**CAN ICES-3 (B)/NMB-3(B)**

(can\_b\_02)

# PRECAUTIONS

## PLEASE READ CAREFULLY BEFORE PROCEEDING

Please keep this manual in a safe and handy place for future reference.



## WARNING

Always follow the basic precautions listed below to avoid the possibility of serious injury or even death from electrical shock, short-circuiting, damages, fire or other hazards. These precautions include, but are not limited to, the following:

### Do not open

- This instrument contains no user-serviceable parts. Do not open the instrument or attempt to disassemble or modify the internal components in any way. If it should appear to be malfunctioning, discontinue use immediately and have it inspected by qualified Yamaha service personnel.
- Repairs or part replacement should not be attempted unless instructions are provided in the manual.

### Water warning

- Do not expose the instrument to rain, use it near water or in damp or wet conditions, or place on it any containers (such as vases, bottles or glasses) containing liquids which might spill into any openings. If any liquid such as water seeps into the instrument, turn off the power immediately. Then have the instrument inspected by qualified Yamaha service personnel.

### Fire warning

- Do not put burning items, such as candles, on the unit. A burning item may fall over and cause a fire.

### Battery

- Follow the precautions below. Failure to do so might result in explosion, fire, overheating or battery fluid leakage.
  - Do not tamper with or disassemble batteries.
  - Do not dispose of batteries in fire.
  - Do not attempt to recharge batteries that are not designed to be charged.
  - Keep the batteries separate from metallic objects such as necklaces, hairpins, coins, and keys.
  - Use the specified battery type (page 9) only.
  - Use new batteries, all of which are the same type, same model, and made by the same manufacturer.

- Always make sure all batteries are inserted in conformity with the +/- polarity markings.
- When the batteries run out, or if the instrument is not to be used for a long time, remove the batteries from the instrument.
- When using Ni-MH batteries, follow the instructions that came with the batteries. Use only the specified charger device when charging.

- Keep batteries away from small children who might accidentally swallow them.
- If the batteries do leak, avoid contact with the leaked fluid. If the battery fluid should come in contact with your eyes, mouth, or skin, wash immediately with water and consult a doctor. Battery fluid is corrosive and may possibly cause loss of sight or chemical burns.

### If you notice any abnormality

- When one of the following problems occur, immediately turn off the power switch (If you are using batteries, remove all batteries from the instrument.) Then have the device inspected by Yamaha service personnel.
  - It emits unusual smells or smoke.
  - Some object has been dropped into the instrument.
  - There is a sudden loss of sound during use of the instrument.
  - If any cracks or breakages exist on the instrument.

### Handling warning

- When moving any movable parts, be careful not to pinch your fingers or hands, to avoid possible injury.

### About the supplied soft case

- Do not carry the supplied soft case over your shoulder while riding a motorcycle or bicycle, etc. Doing so could cause you to fall or have an accident.



## CAUTION

Always follow the basic precautions listed below to avoid the possibility of physical injury to you or others, or damage to the instrument or other property. These precautions include, but are not limited to, the following:

### Assembly

- Assemble the instrument in the proper sequence by following the assembly instructions in this manual. Also, make sure to tighten the screws or bolts regularly. Failure to do so might result in damage to the instrument or even injury.

### Transport / Installation

- Before moving the instrument, remove all connected cables, to prevent damage to the cables or injury to anyone who might trip over them.
- Do not stand the instrument in an unstable place, and make sure to lay it on the floor. Putting it in an unstable position could cause the instrument to fall and result in damage or injury.
- Handle the neck and the body when moving the instrument. Handling the instrument by only the side plate unit could result in malfunction to the side plate unit.

### Connections

- Before connecting the instrument to other electronic components, turn off the power for all components. Before turning the power on or off for all components, set all volume levels to minimum.
- Be sure to set the volumes of all components at their minimum levels and gradually raise the volume controls while playing the instrument to set the desired listening level.

### Handling caution

- Do not insert your finger or hand in any gaps on the instrument. Also take care that the frame unit and the optional accessories does not pinch your finger. Failure to do so might result in injury.
- Do not rest your weight on, or place heavy objects on the instrument, and do not use excessive force on the buttons, switches or connectors.
- Keep small parts out of the reach of infants. Your children may accidentally swallow them.
- Do not use the instrument for a long period of time at a high or uncomfortable volume level, since this can cause permanent hearing loss. If you experience any hearing loss or ringing in the ears, consult a physician.
- The ends of the strings are sharp and can cut fingers. Use caution when changing strings.
- When changing or adjusting strings, do not put your face close to the instrument. The string may suddenly break resulting in eye injury or other accidents.

### About the supplied soft case

- Do not swing the supplied soft case or the strap. Doing so could cause an accident

Yamaha cannot be held responsible for damage caused by improper use or modifications to the instrument.

Always turn the power off when the instrument is not in use.

When disposing of this product, please contact the appropriate local authorities.

Make sure to discard used batteries according to local regulations.

# NOTICE

---

To avoid the possibility of malfunction/damage to the product or damage to other property, follow the notices below.

## ■ Handling

- Do not expose the instrument to excessive dust or vibrations, or extreme cold or heat (such as in direct sunlight, near a heater, or in a car during the day) to prevent the possibility of panel disfiguration, damage to the internal components or unstable operation.
- Do not use the instrument in the vicinity of a TV, radio, stereo equipment, mobile phone, or other electric devices. Otherwise, the instrument, TV, or radio may generate noise.
- When cleaning the instrument, use a soft cloth. Do not use paint thinners, solvents, alcohol, cleaning fluids, or chemical-impregnated wiping cloths.

## ■ About the supplied soft case

- Do not use the supplied soft case to store any other instrument not intended for use with the supplied case.
- Do not drop or subject the supplied soft case to strong shock with the instrument stored inside. Doing so may damage the instrument.
- Do not expose the supplied soft case to direct sunlight (such as in a car during the day), or extremely high temperatures (such as close to a heater). Doing so may result in discoloration or deterioration.
- Do not place near oils or chemicals. They may deteriorate the cover.
- Do not use the supplied soft case if it is torn or split.

## ■ About this manual

- The illustrations as shown in this manual are for instructional purposes only, and may appear somewhat different from those on your instrument.

The model number, serial number, power requirements, etc., may be found on or near the name plate, which is at the rear of the unit. You should note this serial number in the space provided below and retain this manual as a permanent record of your purchase to aid identification in the event of theft.

**Model No.**

---

**Serial No.**

---

(rear\_en\_01)

# Included Accessories

After opening the packaging, please check that all the parts listed below are included.

• Main body x 1

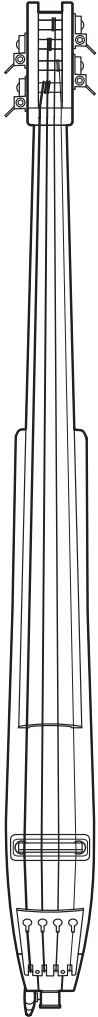

• Frame unit x 1



• End pin x 1



• Mute x 1

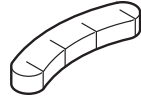

• Allen wrench x 1



• Soft case x 1

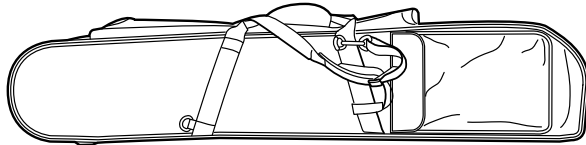

• Owner's Manual (this document) x 1

• List of service locations x 1

\* Two AA batteries (alkaline or nickel hydride) are required to use this product.

## Optional Accessories

- Stand for SILENT Bass™ (BST1)
- Knee support for SILENT Bass™ (BKS2)
- Extension frame for SILENT Bass™ (BEF2)

To purchase these optional accessories, please inquire with your authorized Yamaha dealer.



# Parts and their Names

## ■ Front

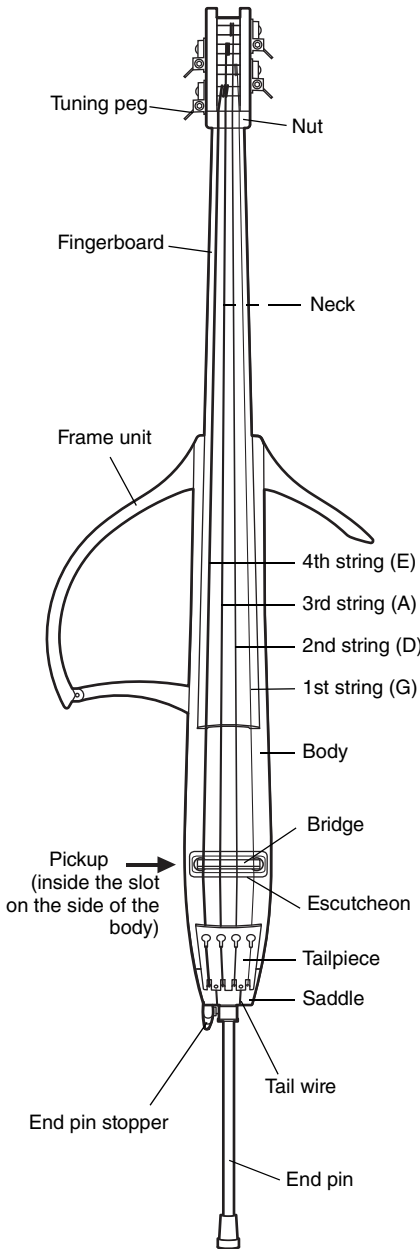

## ■ Rear

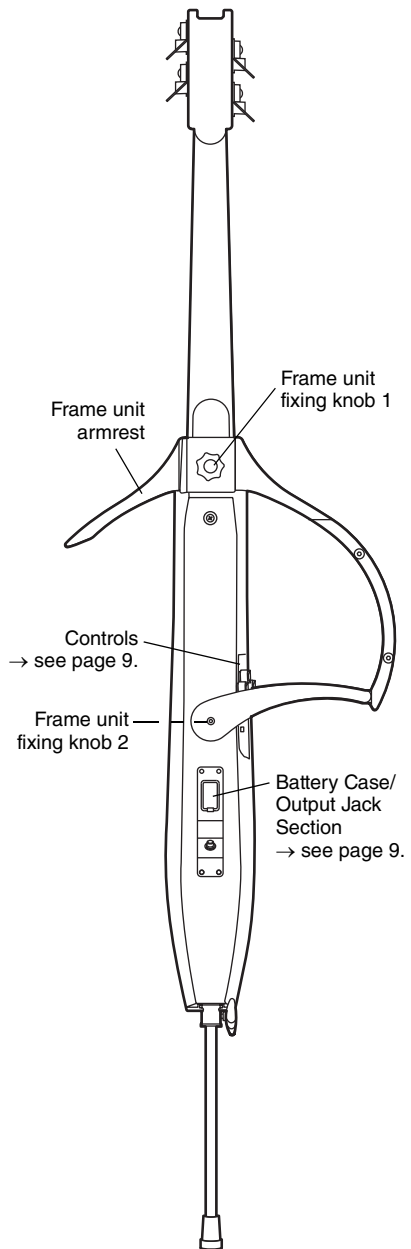

## ■ Battery Case/External Output (LINE OUT) Jack

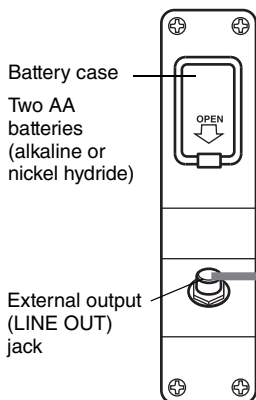

### NOTICE

- Sound will not be output if you connect headphones to the LINE OUT jack of this product.
- When making connections to the LINE OUT jack, be sure to use a standard monaural phone plug cable.

Mixer, recorder, bass amplifier, powered speaker, electric tuner, etc.

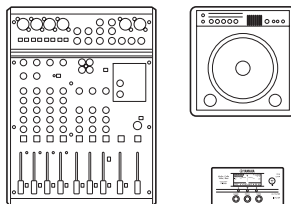

## ■ Controls

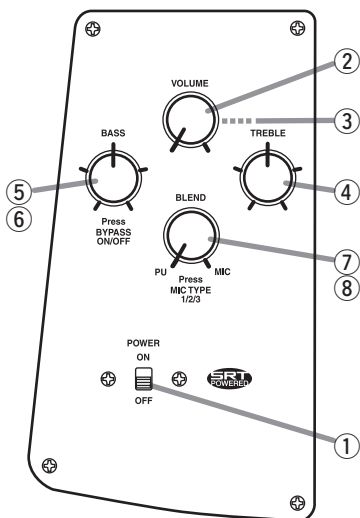

### ① [POWER] (power switch)

This switch turns the power for the built-in SRT POWERED preamplifier on and off.

### NOTE

- This product is designed so that the power can be turned on only when a plug (cable) is inserted into the LINE OUT jack. When a plug is not inserted into the LINE OUT jack, the power will remain off regardless of the position of the power switch.
- If the power switch is off while a plug (cable) is inserted into the LINE OUT jack, the Piezo Pickup signal will be directly output to the LINE OUT jack (passive output). Passive output is used in emergency situations when there are no batteries, or when using sound reproduction on an external device, such as a preamplifier.
- Since the power is turned off during passive output, the SRT POWERED preamplifier will not operate. Except for the power switch, the knobs on the control panel will all be disabled.

### Power Switch and LINE OUT Jack Status Correspondence Table

|               |                   | Power switch                                   |                             |
|---------------|-------------------|--|-----------------------------|
|               |                   | ON   | OFF                         |
| LINE OUT jack | Plug inserted     | Power on<br>SRT POWERED preamplifier operating | Power off<br>Passive output |
|               | Plug not inserted | Power off<br>Not operating                     |                             |

**NOTE**

- When using passive output with the power switch off, the signal output decreases relative to the length of the connected cable. When using the SRT POWERED preamplifier with the power switch on, the cable length has virtually no effect on the signal output.

**NOTICE**

- Turn the power off or turn the output volume all the way down for any connected amplifier, powered speaker, or the like before turning the power for this product on or off.

② **[VOLUME] knob**

This adjusts the volume.

③ **Status display LED** (directly beneath the volume control knob)

This displays information such as the BYPASS function status, SRT POWERED microphone type, and remaining battery power. The LED status can be checked from the diagonal direction (performance posture) relative to the knob.

| Status   | Orange                           | Green | Red     |
|--|----------------------------------|-------|---------|
| Power switch on  | Flashes based on microphone type | –     | –       |
| Switch to microphone type 1 and check selection status | Flashes 1 time                   | –     | –       |
| Switch to microphone type 2 and check selection status | Flashes 2 times                  | –     | –       |
| Switch to microphone type 3 and check selection status | Flashes 3 times                  | –     | –       |
| Using bypass   | –                                | On    | –       |
| Out-of-battery warning                                 | –                                | –     | Flashes |

④ **[TREBLE] knob**

This adjusts the level of the upper frequencies (TREBLE). This uses a peaking filter to amplify or decrease the characteristic frequencies optimized for this product.

- Turn to the right to create a brighter sound that can cut through the sound of other instruments in a band.
- Turn to the left for a soft, natural sound fit for bowing.

⑤ **[BASS] knob**

This adjusts the level of the lower frequencies (BASS). This uses a peaking filter to amplify or decrease the fundamental frequencies mainly of the 3rd and 4th strings.

- Turn to the right to emphasize the low frequencies and create a warm, fat sound.
- Turn to the left to cut the low frequencies for a clean sound that does not clash with other low-pitched instruments.

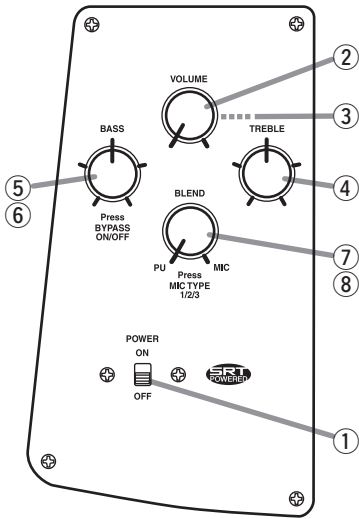

### ⑥ [BYPASS] button

This button bypasses all controls except for the [VOLUME] of the SRT POWERED preamplifier. You can use this button to instantly switch between the processed SRT POWERED sound and the dry signal output. While the bypass function is enabled, the LED for ③ is lit up in green.

#### NOTE

- If you want to output the dry sound while still in active output, use the bypass function with the power switch on.

### ⑦ [BLEND] knob

This adjusts the amount of mixing between the signal from the pickup and the simulated microphone signal. Turn it all the way to the left to set the signal from the pickup to 100%. Turn it all the way to the right to set the simulated microphone signal to 100%.

### ⑧ [MIC TYPE] button

This selects the type of microphone to be simulated in the SRT POWERED system. Press and hold the microphone type switching button (BLEND knob) until the status display LED flashes to change the microphone type. The microphone type switches in order as follows: microphone type 1 → microphone type 2 → microphone type 3 → microphone type 1. If you press the button quickly, you can check the microphone type currently selected from the number of flashes.

#### ● Microphone type 1: Rich

Well-balanced, rich sound from a classic vintage vacuum-tube microphone.

#### ● Microphone type 2: Simple

Clear, clean sound from a dynamic microphone.

#### ● Microphone type 3: Warm

Warm sound with low-frequency emphasis from a famous vacuum-tube microphone, different from type 1.

# Setup

## ■ Tuning

The SILENT Bass™ is shipped from the factory with the bridge in place and the strings slightly loosened. The bridge's height is set to an average person's height. Since the position of the bridge will sometimes shift during transport, make sure to properly adjust the position of the bridge before tuning the strings.

- The lower side of the bridge supports the 1st string (G), the higher side supports the 4th string (E). When looking at the bridge from the side, the surface that has a sharper curve should face the fingerboard (facing up when in the playing position). (Fig. 1)
- The correct position for the bridge is where the surface of the bridge facing the tailpiece is at a right angle to the body surface on which the bridge rests. [Fig. 2] Position the bridge so that its legs do not come in contact with the escutcheon (the plastic part).

[Fig. 1 :  
Looking from the tailpiece]

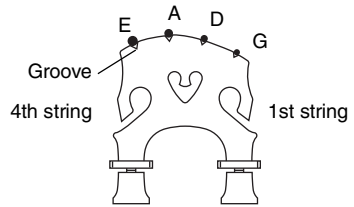

[Fig. 2: Bridge stands vertically to surface A]

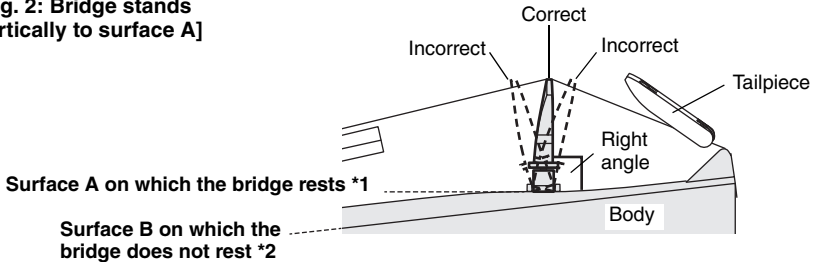

\*1 Check that the bridge is vertically aligned with surface A, on which the bridge rests.

\*2 Surface B, on which the bridge does not rest, and surface A, on which the bridge does rest, are not parallel. Surface B, on which the bridge does not rest, cannot be used to check that the bridge is vertical.

## Adjustments If the Bridge Is Leaning

- After tuning, check that the surface of the bridge facing the tailpiece is vertical to the body surface on which the bridge rests. If it is leaning to one side, slightly loosen the strings and then use both hands to raise the bridge.
- If, after tuning, the tailpiece is leaning to one side when seen from the front, slightly loosen all the strings and manually straighten the tailpiece. After that, increase the tension of all the strings as evenly as possible and then re-perform tuning.

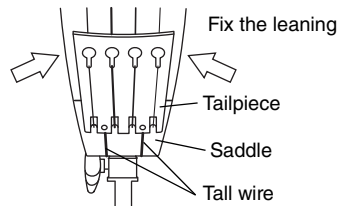

- The height of the bridge for the SILENT Bass™ can be adjusted. Turn the metal adjusters clockwise to lower the bridge, and counter-clockwise to raise it. [Fig. 3]

[Fig. 3: Adjusting bridge height]

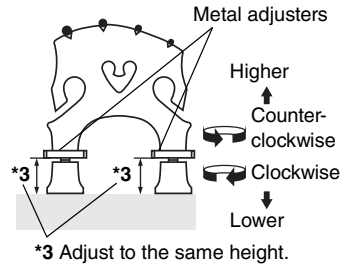

**NOTICE**

- Before adjusting the bridge height, loosen the strings in order to relieve pressure on the adjusters and make it easier to rotate the adjusters. Rotating the adjusters with without reducing string tension can result in damage to the bridge or strings, etc.
- When adjusting the bridge height, make sure that the height of both legs is kept the same. Increasing string tension on legs that are unequal in height can result in poor surface contact of the bridge's feet, causing inferior sound quality, noise, damage to the bridge, etc. (Fig. 3 \*3).

- The strings are tuned to the following pitches. The 1st string is tuned to G, the 2nd string to D, the 3rd string to A, and the 4th string to E. Use a piano, tuning fork, tuner, etc., and adjust the pitch of each string using the tuning pegs.

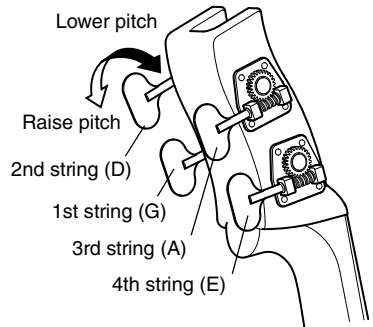

● **Tuning machine tension adjustment**

The tuning machine tension regulates the amount of pressure required to turn the tuners and can be adjusted using the supplied Allen wrench.

- **If the tuning machine turns with very slight pressure**  
→ Rotate the adjustment screw to the right (clockwise: **A**).
- **If the tension is tight and the tuning machine is hard to turn**  
→ Rotate the adjustment screw to the left (counter-clockwise: **B**).

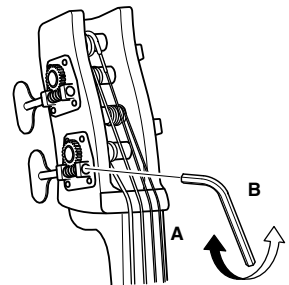

## ■ Attaching the Frame Unit

The SILENT Bass™ is shipped from the factory with the frame unit removed from the main body.

Before using this product, please properly attach the frame unit to the main body using the following procedure.



**When moving the upper arm support and the arm section of the frame unit, be careful not to pinch your fingers, hands, or the like.**

### ● Installation Procedure

1. Open the upper arm support on the frame unit, until it comes in contact with the stopper.
2. With the frame unit's arm section (fixing screw 2) still closed (raised), gently slide the indentation of the frame unit's upper part in the direction of "2 Slide" in the figure below.
3. Tighten fixing screw 1.
4. Rotate the arm section counter-clockwise to open it up, and insert fixing screw 2 into the holder on the bass instrument.
5. Tighten fixing screw 2 to secure the frame unit to the bass instrument.

Frame attachment is complete.

To remove the frame unit, simply reverse the procedure described above.

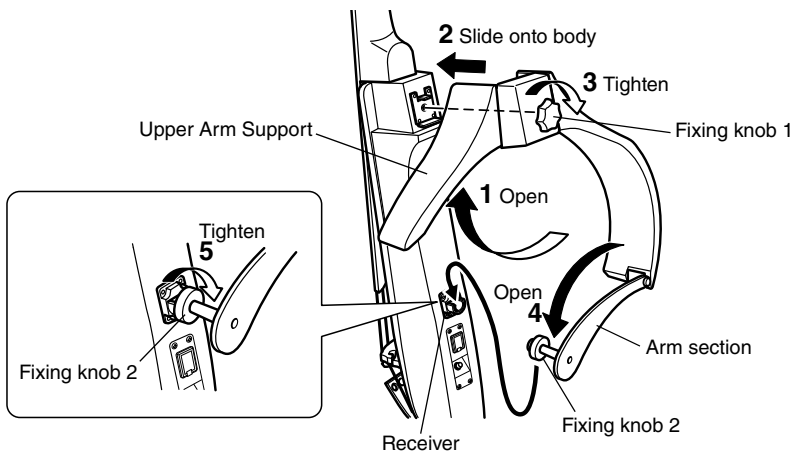

**When transporting the instrument, always hold it by the neck and the body. Holding by the frame unit only may result in damage to the frame unit.**

### NOTICE

- Securely tighten fixing knobs 1 and 2. Using the instrument with the attachments loose can result in parts rattling or making noise during performance.

## ■ About the End Pin

The SILENT Bass™ is shipped from the factory with its end pin removed from the main body and stored separately in the soft case. Before using the instrument, loosen the end pin stopper and insert the end pin, and then after determining a comfortable playing height, securely tighten the end pin stopper.

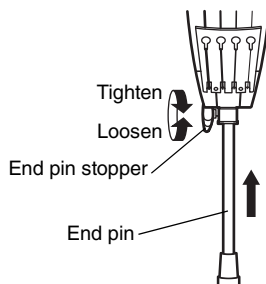

### NOTICE

- Make sure the end pin stopper is secured firmly to prevent the instrument from falling while you play.
- To ensure optimal performance, the end pin is designed to fit into the bass instrument at an angle and cannot be fully inserted. Trying to force the end pin all the way in or subjecting it to an impact can damage parts inside the bass instrument. Proceed slowly and carefully when inserting or removing the end pin.

## ■ Attaching the Optional Accessories

### ● Knee Support for the SILENT Bass™ (BKS2)

With the optional BKS2 Knee Support, the instrument can be leaned against the left knee when playing while sitting on a stool, etc.

As shown in Fig. A, align the end of the metal frame unit with the matching indentation on the knee support, and use the three screws to secure the support in place.

[Fig. A]

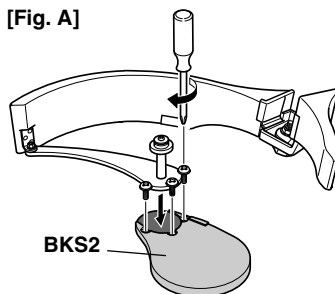

### ● Extension Frame for the SILENT Bass™ (BEF2)

The optional BEF2 Extension Frame widens the frame unit to provide greater instrument support.

As shown in Fig. B, use the two screws to secure the support in place.

[Fig. B]

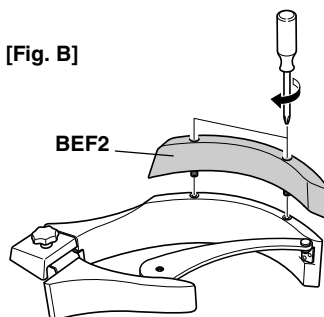

### NOTICE

- Before attaching or removing any optional parts, remove the frame unit from the bass instrument and place the frame on a stable surface.
- Before playing the instrument, make sure that the optional parts are not loosely attached.



## ■ Preparing the Power Supply (How to Replace Batteries)

The SILENT Bass™ uses batteries for its power source.

Before installing or removing the batteries, remove the cable from the output jack.

1. On the backside of the instrument, push down the battery case's latch in the direction of the "OPEN" arrow to remove the battery case.

### NOTICE

- When removing the battery case, tilt the instrument body at an angle to prevent the battery case from flying out.

2. Insert the batteries into the case. Referring to the illustration, make sure the batteries are placed in the case with the polarity (+/-) properly aligned.
3. Push in the battery case all the way until you hear a click.

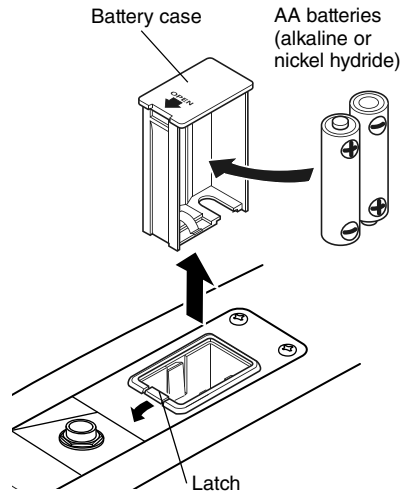

## ● When to Replace the Batteries

- When the batteries are running low, the status display LED flashes in red. Promptly replace the batteries.
- With nickel hydride batteries, the discharge properties may cause the power to turn off before the LED flashes in red.



Be careful of the following when replacing the batteries.

- **Battery shapes (battery terminals and external shapes, etc.) vary depending on the battery manufacturer. Inserting a battery with a shape different from the battery case may damage the instrument or the like. Even if the batteries fit in, poor contact with the terminals can cause a fire.**
- **Always follow the polarity signs (+/-) when inserting batteries. Improper insertion can cause a fire.**
- **If not using the instrument for a long period of time, remove the batteries from the instrument. Failure to do so can cause battery drainage or damage to the instrument due to battery leakage.**

## ■ Connection Example

Refer to the connection example below and connect this product to an external device.

- Turn off the power for all devices before performing connections.
- When making connections, first check the shape of the connection jack, be sure to use a plug cable that meets the jack standards, and make the connection firmly.

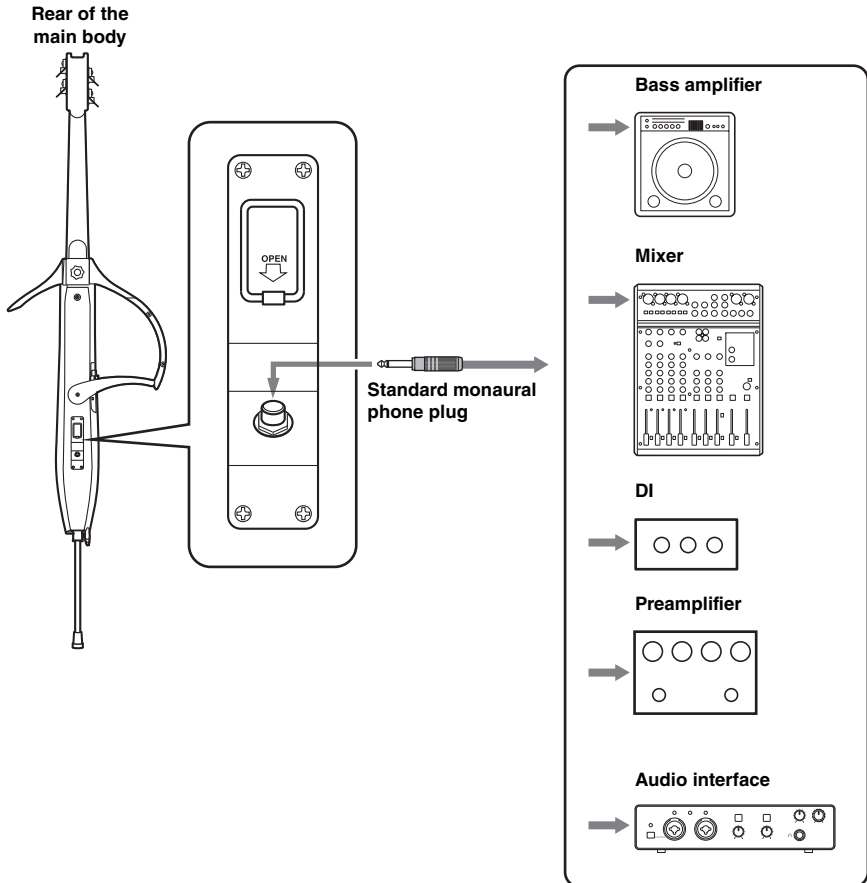

\* All illustrations and figures are for instruction purposes. The actual specifications may vary.

## ■ Turning the Power On and Off



With a plug (cable) inserted into the LINE OUT jack of this product, push the [POWER] switch up to turn the power on, and down to turn the power off. When the power turns on, the status display LED will flash (page 10).

### NOTE

- To prevent the battery from being depleted, be sure to turn the Power switch off after finishing use. Also, remove the cable.
- You can use this product even without batteries by turning the power switch off (to passive output) and connecting the product to an external device that supports passive output. When using an external device, connect a device (DI, etc.) that has input impedance of 10 MΩ or higher. Sufficient output and frequency characteristics may not be ensured if the input impedance of the connected device is lower than the specified value.

### NOTICE

- To prevent faults in this product or the external device as well as noise, be careful regarding the order in which you turn the power switch on or off and make connections.

#### Order for Turning the Power Switch Off and Making Connections (Example)

1. Lower the level of the channel to which this product is connected on the output device, such as a PA.
2. Turn off the power switch of this product.
3. Disconnect this product and the output device, such as a PA.
4. Connect this product and a DI or the like already connected to a PA or the like.
5. Check that the level of the channel to which a DI or the like is connected on the output device such as a PA is lowered.
6. Turn on the switch of the DI or the like.
7. Raise the level of the channel to which a DI or the like is connected on the output device such as a PA.

## ■ About the Mute

Since the SILENT Bass™ is designed with a pickup system that picks up string vibration, the system can sometimes pick up string vibrations that occur between the bridge and tailpiece. If this sound is bothersome or unwanted, you can mute it by attaching the supplied mute onto the strings as shown in the illustration below.

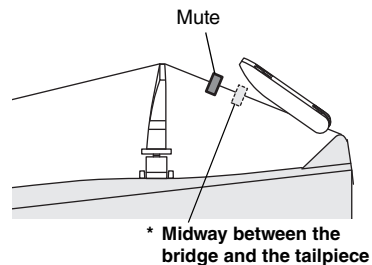
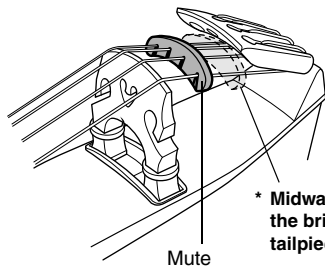

- \* The effectiveness of the mute will be reduced if it is attached midway between the bridge and the tailpiece.

# Changing Strings

Make sure you purchase Double Bass strings. The SILENT Bass™ uses a string length of 1,040 mm (41").



- The ends of the strings are sharp and can cut fingers. Use caution when changing strings.
- When changing or adjusting strings, do not put your face close to the instrument. The string may suddenly break resulting in eye injury or other accidents.

## NOTICE

- Do not remove all strings at the same time. Make sure to change the strings one at a time.

## ● Winding the Strings

1. Hook the string's ball end into the string hole on the tailpiece. Make sure that the ball end is securely positioned in the end of the string hole slit.
  - \* If the ball end is larger than the string hole, thread the opposite end of the string through the hole from the back side of the tailpiece.
2. Pull the string down toward the end pin and wrap the string around the end of the tailpiece making sure it fits into its corresponding groove at the bottom of the tailpiece. Pull the string up and over the bridge.

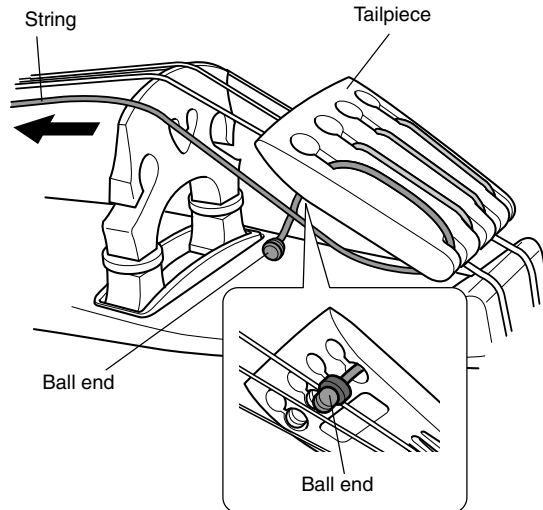

- Insert the end of the string into the hole on the peg, turn the peg and make one or two wraps to one side of the hole as shown in the illustration below, and then make the remaining wraps in the opposite direction. From the perspective at the front of the instrument, the first couple of wraps on the 1st (G) and 2nd (D) strings should be to the left of the hole, whereas on the 3rd (A) and 4th (E) strings, the first wraps should be made to the right.

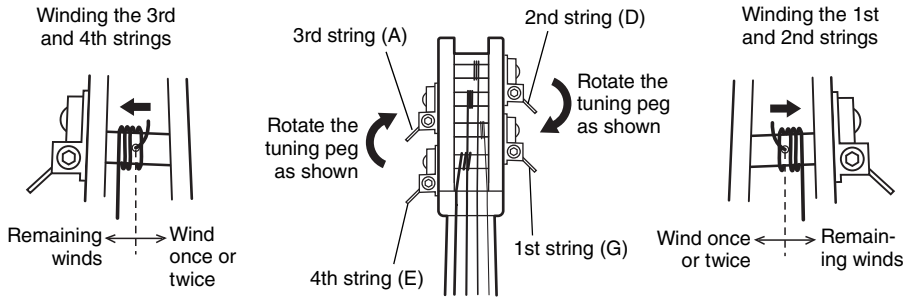

#### NOTICE

- Before winding the strings, stand the bridge so that the surface of the bridge facing the tailpiece is vertical to the body surface on which the bridge rests.
- Before winding the strings, make sure that each string is positioned in its corresponding groove on the bridge.
- Before winding the strings, the adjust string length so that the string does not rub up against the pegbox wall. Performing tuning while a string is rubbing up against the wall can result in a broken string or the like.
- When winding strings, be careful that the bridge is not pulled by the strings and pushed down towards the fingerboard.

- Turn the pegs to perform tuning to match the sound of a piano, tuning fork, tuner, or the like.

For more information about tuning, see the cautionary notes under “Tuning” (page 12).

#### NOTICE

- When not using the instrument for a long period of time, slightly loosen the strings before storage.
- Always use the product with the bridge standing vertical to the surface on which the bridge rests. Using the product with the bridge leaning to one side can shorten the service life of the bridge and reduce sound quality.

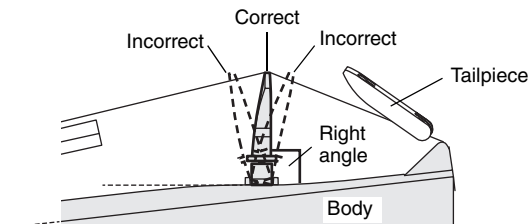

# Putting the Bass into the Soft Case

---

When storing the bass in the supplied soft case, remove the frame unit and end pin from the bass and store them in the case separately as shown in the illustration below.

- Use the Velcro® cover to secure the end pin in place inside of the soft case.
- When putting the bow in the soft case, first make sure that it is put into the hard bow case, and then place the hard case in the pocket and secure with a Velcro® fastener (1 location).

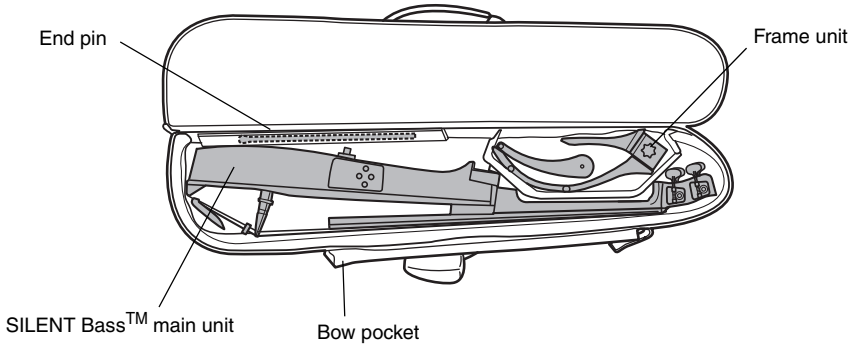

## NOTICE

- The soft case is meant for carrying this product during transportation and protecting it from dust or the like. It is not meant to ensure the safety of the bridge and other parts. Placing the bridge surface downward, placing objects on the case, or subjecting it to an impact can damage this product.

# Specifications

---

|  |   |
|--|---|
| <b>Neck</b>                                  | Maple   |
| <b>Body</b>                                  | Spruce + mahogany   |
| <b>Fingerboard</b>                           | SLB300 PRO: Ebony<br>SLB300: Rosewood   |
| <b>Bridge</b>                                | Maple (height is adjustable)  |
| <b>Frame Unit</b>                            | Beech + metal parts (aluminum, etc.)  |
| <b>Tuning Pegs</b>                           | Worm gear type  |
| <b>Tailpiece</b>                             | Ebony (reverse type)  |
| <b>Strings</b>                               | Double bass strings (ball-end type)   |
| <b>Sensor</b>                                | Piezo pickup  |
| <b>Controls</b>                              | <ul style="list-style-type: none"><li>• Volume control knob</li><li>• Treble control knob</li><li>• Bass control knob / Bypass button</li><li>• Blend control knob / Microphone type switch button</li></ul>  |
| <b>Power</b>                                 | AA battery (alkaline or nickel hydride) x 2   |
| <b>Battery Life (normal, continuous use)</b> | <p><b>Alkaline battery:</b> Approx. 32 hours<br/>Time usable after warning display flashes: Approx. 4 hours</p> <p><b>Nickel hydride battery:</b> Approx. 26 hours<br/>Time usable after warning display flashes: Approx. 1 hour</p>  |
| <b>String Length</b>                         | 1,040 mm (41")  |
| <b>Dimensions (L x W x H)</b>                | <p><b>Dimensions including attachments (with frame unit attached and end pin at its shortest)</b><br/>1,692 x 456 x 330 mm (66-5/8" x 17-15/16" x 13")</p> <p><b>Body Dimensions (with frame unit and end pin removed)</b><br/>1,392 x 122 x 230 mm (54-13/16" x 4-13/16" x 9")</p> <p><b>Frame Unit Dimensions (folded)</b><br/>465 x 145 x 129 mm (18-5/16" x 5-11/16" x 5-1/10")</p> |
| <b>Weight</b>                                | SLB300 PRO: Approx. 7.0 kg (15 lbs. 7 oz.)<br>SLB300: Approx. 6.8 kg (15 lbs.)  |

\* This document explains the latest specifications at the time it was issued. The latest edition can be downloaded from Yamaha's website.

## 雅马哈乐器音响（中国）投资有限公司

上海市静安区新闻路1818号云和大厦2楼

客户服务热线：4000517700

公司网址：<http://www.yamaha.com.cn>

制造商：雅马哈株式会社

制造商地址：日本静冈县滨松市中区中泽町10-1

进口商：雅马哈乐器音响（中国）投资有限公司

进口商地址：上海市静安区新闻路1818号云和大厦2楼

原产地：日本

### Yamaha Global Site

<https://www.yamaha.com/>

### Yamaha Downloads

<https://download.yamaha.com/>

Manual Development Group

© 2019 Yamaha Corporation

Published 08/2021

2021年8月 发行 R2

POTO-C0

VFA5990